

2002

A model-based definition of the generic remanufacturing business process

Ijomah , Winifred

<http://hdl.handle.net/10026.1/601>

<http://dx.doi.org/10.24382/4865>

University of Plymouth

All content in PEARL is protected by copyright law. Author manuscripts are made available in accordance with publisher policies. Please cite only the published version using the details provided on the item record or document. In the absence of an open licence (e.g. Creative Commons), permissions for further reuse of content should be sought from the publisher or author.

**A MODEL-BASED DEFINITION OF THE GENERIC
REMANUFACTURING BUSINESS PROCESS**

By

WINIFRED LOUISSA IJOMAH

A thesis submitted to the University of Plymouth
in partial fulfilment for the degree of

DOCTOR OF PHILOSOPHY

Plymouth Business School

May 2002

Thesis Confidentiality Declaration

The information contained in this thesis is confidential for two years. As such, the thesis is embargoed for two years, commencing from 25th October 2002 and ending on 25th October 2004. Following this period the thesis will be made available as per the standard practice of the University of Plymouth.

This copy of the thesis has been supplied on condition that anyone who consults it is understood to recognise that its copyright rests with its author and that no quotation from the thesis and no information derived from it may be published without the author's prior consent.

Winnie Louissa Ijomah

A Model-Based Definition of the Generic Remanufacturing Business

Process

Abstract

Remanufacturing is a process of bringing used products to a “like-new” functional state by rebuilding and replacing their component parts. The practice has a low profile in world economies, however, studies indicate that it obtains cost savings in the region of 20% to 80%, as well as quality similar to that of an equivalent “new” product. In fact, in excess of 73,000 firms are engaged in some sort of remanufacturing in the United States alone. The key remanufacturing issues are the ambiguity in its definition and the scarcity of its analytic models. The objective of the research was to address these issues, and was achieved using a 3-Phase research approach that followed Eisenhardt’s (1989) case study methodology. Initially, the research examined remanufacturing operations in order to unambiguously define it. Following this, the remanufacturing business process was modelled to define remanufacturing in the context of its total system.

The research contributions are a robust definition of remanufacturing and a comprehensive generic model of the remanufacturing business process. The research beneficiaries are industry and academia, because the unambiguous definition permits remanufacturing to be differentiated from alternative secondary market operations for the first time. This assists researchers to explicitly understand remanufacturing so they can undertake effective remanufacturing research and correctly disseminate their findings. The generic model is a remanufacturing-specific, analytic error-reduction tool to reduce risk in remanufacturing. The research originality is that for the first time remanufacturing has been analysed from a business process perspective, an unambiguous definition of remanufacturing is determined and a generic model of the remanufacturing business process has been established.

Contents

Abstract	3
Acknowledgement	16
Author's declaration	17
Glossary	18
Chapter 1: Introduction	
1.1 Introduction	21
1.2 The remanufacturing concept	22
1.3 The significance of remanufacturing	23
1.4 The key remanufacturing problems	23
1.5 The significance of the research	24
1.6 Domain of the research	24
1.7 Objective of the research	24
1.8 Research questions	25
1.8.1 What is remanufacturing?	25
1.8.2 How is remanufacturing undertaken?	25
1.8.3 What are the key remanufacturing problems?	26
1.8.4 How can the knowledge be made useful to others?	26
1.8.5 Is the new knowledge valid and useful to practitioners?	27
1.9 The deliverable and originality of the research	27
1.10 The beneficiaries of the research	28
1.11 Methodology	29
1.12 The structure of the thesis	30
1.13 Summary	34

Chapter 2: The significance of remanufacturing	
2.1 Introduction: Objectives of the chapter	35
2.2 The definition of remanufacturing initially adopted by the research	35
2.2.1 Other remanufacturing-industry definitions used in this thesis	36
2.3 History of remanufacturing	36
2.4 The remanufacturing industry	37
2.4.1 The characteristics of remanufacturable product	37
2.4.2 Sectors of the remanufacturing industry	37
2.4.3 Types of remanufacturing practitioners	38
2.4.3.1 The original equipment manufacturer (OEM)	38
2.4.3.2 The non-contract remanufacturer	38
2.4.3.3 The contract remanufacturer	39
2.5 The major remanufacturing drivers	40
2.6 The cost reducing characteristics of remanufacturing	40
2.6.1 Reduced labour costs	40
2.6.2 Reduced energy costs	41
2.6.3 Reduced materials costs	41
2.6.4 Reduced disposal costs	42
2.6.5 Examples of the profit and cost savings obtained from remanufacturing	42
2.7 Additional benefits from remanufacturing	44
2.8 Comparison of remanufacturing and related production processes	45
2.8.1 Remanufacturing versus conventional manufacturing	45
2.8.2 Remanufacture versus reconditioning and repair	47
2.9 Existing research in remanufacturing	48
2.9.1 Ecodesign research	48

2.9.2 Remanufacturing specific research	49
2.9.2.1 Examination of remanufacturing practice	49
2.9.2.2 Research to improve the efficiency of remanufacturing operations	50
2.10 The case for the research	54
2.11 Summary	56
Chapter 3: The research design	
3.1 Introduction	57
3.2 The philosophical paradigm and research design	57
3.2.1 Ontology	57
3.2.2 Epistemology	58
3.2.3 Axiology	58
3.2.4 Rhetoric	59
3.2.5 Methodology	59
3.3 Rationale for adopting qualitative paradigm	60
3.4 Rationale for the case study approach	61
3.5 The legitimacy of the research	64
3.5.1 Construct validity	65
3.5.2 Reliability	66
3.5.3 External validity	66
3.6 The issues considered in the choice of research methodology	67
3.6.1 The researcher's involvement	68
3.6.2 The domain of the research	68
3.6.3 The needs of the practitioner	68
3.7 Eisenhardt's case study theory building framework	71
3.7.1 Getting started	71

3.7.2 Selecting cases	71
3.7.3 Crafting instruments and protocol	72
3.7.4 Entering the field	72
3.7.5 Analysing data	72
7.6 Shaping hypothesis	73
3.7.7 Enfolding literature	74
3.7.8 Reaching closure	74
3.8 The overall structure of the case study research	75
3.8.1 Literature survey	75
3.8.2 Obtaining case study companies	75
3.8.3 Research design	76
3.8.4 Developing a robust new definition of remanufacturing	78
3.8.5 Validating the new definition	79
3.8.6 Analysing the new definition	79
3.8.7 Examination of the IDEF0 modelling technique	79
3.8.8 Making the research findings useful to others	80
3.8.9 Validating the model	80
3.9 Summary	81
Chapter 4: the Phase 1 case studies	
4.1: Introduction	82
4.2 The Phase 1 case study procedure	82
4.2.1 Key personnel interview	84
4.2.2 First-hand information-capture	84
4.2.3 Interpretation of information	84
4.2.4 Refine/amend recorded information	85

4.3 The Phase 1 remanufacturing operations	86
4.3.1 Company A	86
4.3.2 Company B	93
4.3.3 Company C	99
4.3.4 Company D	105
4.3.5 Company E	110
4.4 Analysis of the Phase 1 case study evidence	118
4.4.1 Contract and independent remanufacturers	119
4.4.2 The key remanufacturing problems	119
4.4.3 The key remanufacturing success factors	121
4.5 Summary	122
Chapter 5: Overview of remanufacturing practice	
5.1 Introduction	123
5.2 The generic remanufacturing operational flow chart	123
5.2.1 Receive core	124
5.2.2 Clean and strip core	126
5.2.3 Investigate core and quote	126
5.2.4 Remanufacture components	126
5.2.5 Assemble and test	127
5.3 Characteristics of remanufacturing business operations	128
5.3.1 Uncertainty	128
5.3.1.1 Inability to predict the quantity of cores that will be received	128
5.3.1.2 Inability to predict the quality of incoming cores	129
5.3.1.3 Intellectual property rights restrictions	129
5.3.2 Pricing	130

5.3.3 Core assessment criteria	130
5.3.4 Quality control	131
5.4 Primary production control issues in remanufacturing	131
5.4.1 The “investigate core” sub-process	131
5.4.2 The “assess component” activity	132
5.5 Effect of production volume and contracts on remanufacturing operations	133
5.6 The relationship between manufacturing and remanufacturing companies	135
5.7 The major source of savings in remanufacturing operations	135
5.8 The new definition of remanufacturing	136
5.9 Summary	138

Chapter 6: The phase 2 case studies

6.1: Introduction	139
6.2 The Case study organisations	140
Company G	140
6.2.1 Overview of company G’s UK headquarters	141
6.2.2 Brief description of organization G’s remanufacturing operation	142
6.3 Operations G1, G3 and G4’s (The main transmissions sub assembly) remanufacturing operations	143
6.4 Operation G2’s transmissions remanufacturing operation	148
6.5 Operation G5	152
6.6 Company H	160
6.7 Company F	169
6.8 Analysis of the Phase 2 case study findings	176
6.9 Summary	179

Chapter 7: Comparison of remanufacturing, repair and reconditioning

7.1 Introduction	181
7.2 Shortcomings of popular current definitions of remanufacturing.	182
7.2.1 The Amezquita <i>et al.</i> (1996) definition of remanufacturing	182
7.2.2 Haynesworth's definition of remanufacturing	183
7.3 The author's new definition of remanufacturing	185
7.3.1 Remanufacturing	186
7.3.2 Reconditioning	187
7.3.3 Repair	187
7.4 Summary	188

Chapter 8: Process modelling

8.1 Introduction	190
8.2 The Characteristics of appropriate modelling techniques	191
8.3 Examination of the process modelling capabilities of the IDEF 0 modelling technique	192
8.4 A description of the IDEF0 modelling technique	194
8.4.1 The context diagram	195
8.4.2 The node index	195
8.4.3 Activity diagrams	195
8.4.4 For exposition only diagrams (FEO)	195
8.4.5 The glossary	195
8.5 IDEF0 building blocks	196
8.6 Decomposition	197
8.7 Summary	198

Chapter 9: A generic model of the remanufacturing business process	
9.1 Introduction	200
9.2 The model development process	200
9.2.1 The boundaries of the model	202
9.3 The model development process	203
9.3.1 The Phase 3 case study	206
9.3.1.1 Key personnel interviews	206
9.3.2.1 Information capture	206
9.3.1.3 Augment documented information	208
9.3.1.4 Assess documented information	209
9.3.2 Assess model	211
9.3.3 Refine model	211
9.4 Use of the model	212
9.4.1 The model as a remanufacturing-specific error-reduction tool	213
9.4.2 The model as a tool for enhancing the consistency and effectiveness of training	213
9.4.3 The model as an aid for disseminating remanufacturing knowledge	214
9.5 Summary	215
Chapter 10: Validating the model	
10.1 Introduction	216
10.2 Criteria for testing the success of the research	216
10.3 The validating panel	217
10.4 The validation process	218
10.4.1 Distribution of validation documents	221
10.4.2 Demonstration and description of IDEF0	226

10.4.3 Assessment of individual model diagrams	226
10.4.4 Assessment of the total model	226
10.4.5 Analysis of validation results	226
10.5 The results of the validating panels assessment of the model	227
10.5.1 IDEF0 as a modelling technique	229
10.5.2 Descriptive relevance	230
10.5.3 Goal relevance	231
10.5.4 Operational validity	232
10.5.5 Non-obviousness	232
10.5.6 Timeliness	233
10.5.7 Negative points of the evaluation	233
10.6 Conclusions of the validation exercise: validity of the model	235
10.7 Summary	237
Chapter 11: Conclusion	
11.1 Introduction	238
11.2 The key remanufacturing problems	239
11.3 The significance of the research	239
11.4 Objective of the research	241
11.5 Research question	241
11.6 Contribution to knowledge and originality of the research	242
11.7 Beneficiaries	243
11.8 Research methodology	244
11.9 Area of further research	244
11.9.1 Use of the research findings to develop additional remanufacturing-specific tools	244

11.9.2 Research to identify methods to promote contracts between OEMs and remanufacturers	245
11.9.3 Research to encourage the adoption of the new definition	246
11.9.4 Research to use the new knowledge	246
11.10 Limitations of the research	247
11.11 Summary	248
Appendices	
1 The company specific model of remanufacturing	249
2 IDEF0 information leaflet	250
3 The prototype model	251
4 The model description manual	252
5 The completed initial feedback sheets	253
6 The completed secondary feedback sheets	254
7 The Biffawards	255
8 The validated generic model	256
References	257
List of figures	
Figure 1.1: The structure of the thesis	33
Figure 3.1: The overall structure of the case study research	77
Figure 4.1: The Phase 1 case study procedure	83
Figure 4.2: Company A's train remanufacturing operation	88
Figure 4.3: Company B's remanufacturing operation	98

Figure 4.4: Company C's remanufacturing operation	100
Figure 4.5: Company D's remanufacturing operation	107
Figure 4.6: Company E's remanufacturing operation	112
Figure 5.1: A generic remanufacturing operational flow chart	125
Figure 5.2: Manufacturing V remanufacturing operational charts	137
Figure 6.1: G1, G3 and G4's transmission sub assembly remanufacturing operations	144
Figure 6.2: G2's remanufacturing operation chart	150
Figure 6.3: G5's torque converter remanufacturing operation	156
Figure 6.4: Company H's industrial transmissions remanufacturing operation	163
Figure 6.5: Company F's remanufacturing operation diagram	171
Figure 6.6: Company F's repaired and remanufactured compressor system	176
Figure 6.7: The operational charts of contract and non-contract remanufacturers	178
Figure 7.1: The author's hierarchy of secondary market production processes	188
Figure 8.1: Activity box and arrows (ICOMS)	196
Figure 8.2: Decomposition	198
Figure 9.1: The CIM-OSA business process architecture	201
Figure 9.2: Cross-functional nature of business processes representing what actually happens	201
Figure 9.3: The model development process	205
Figure 9.4: The Phase 3 case study	207
Figure 10.1: The validation process	220
Figure 10.2: A typical secondary feedback sheet	225

List of tables

Table 2.1: Cost savings and profits obtained from remanufacturing	44
Table 2.2: Process definitions (Amezquita <i>et al.</i> 1996)	48
Table 4.1: Summary of remanufacturing problems	120
Table 4.2: Desirable characteristics of remanufacturing operations	121
Table 7.1: The author's definitions of the alternative secondary market processes	186
Table 8.1: The process modelling capabilities of the IDEF0 technique	192
Table 10.1: The validating panel	219
Table 10.2: The initial feedback sheet	222
Table 10.3: The initial feedback sheet (continued)	223
Table 10.4: Alterations to enhance the sufficiency and suitability of the model	228
Table 10.5: Alterations to enhance the clarity of the model	229
Table 10.6: Proposed uses for the model	231

Acknowledgement

So many people helped to make this project worthwhile and successful for me.

Acknowledging everyone would make a double thesis in itself so I will nominate only the following few. To the people that are not named I extend my thanks: “Your help was very much valued”.

My biggest “THANK YOU” goes to my family for their continued support. I thank my case study companies and also my supervisors Dr. Bennett and Dr. Childe. I would very much like to thank the late Jean Miller for the immense effort spent on my presentation skills during what must have been an extremely difficult time for herself and her family.

“Thank you” Jim Windmill and Dr. Parkinson for being so supportive even though you were struggling with your own PhDs. I am grateful for the comments of the people that were willing to bore themselves silly reading my thesis, for example, Professor Ifeachor, Professor Mapps, Dr John Bradford, John Hilsdon and Dave Smith.

I would like to acknowledge the generosity of members of the Engineering Design Centre, Ian, Rich, Martin and Stalin, for allowing me to use their departmental resource, likewise Professor Clegg, the Learning Skills Department and Dr. Culverhouse. Many thanks to the University of Plymouth Karate Club, my jogging buddies and all my friends, especially, Sally Edler and Helen Cragg for keeping me sane. I would also like to thank Lorie and Stuart Randall, my present employers at Darp Enviromental Ltd. for their understanding during my writing up. Last, but certainly not least, my thanks goes to the Student Union canteen staff for their friendship, encouragement and the many cases of extra large portions when I was low on finance.

Author's declaration

At no time during the registration for the degree of Doctor of Philosophy has the author been registered for any other University award. This study was financed with the aid of a studentship form the University of Plymouths Department For Business Development. Relevant seminars and conferences were regularly attended at which work was often presented; external institutions were visited for consultation purposes and several papers prepared for publication.

The author's publications during the course of the PhD were

1. Ijomah W, Bennett J, Pearce J (1999) "Organising for re-use: the operational control issues in product remanufacturing". Proceedings of The Second International Working seminar on Re-use
2. Ijomah W, Bennett J, Pearce J (1999). "Coping with uncertainty: production management issues in product remanufacturing", The Proceedings of the Second International SMESME Conference.
3. Ijomah W, Bennett J, Pearce J (1999). "Remanufacturing: evidence of environmentally conscious business practice in the UK". The Proceedings of The Ecodesign'99: First International Symposium on Environmentally Conscious Design and Inverse manufacturing

Presentation and conferences attended include:

1. The Second International Working seminar on Re-use" Eindhoven, Holland 1999
2. The Second International SMESME Conference. Plymouth, UK 1999
3. The Ecodesign'99: First International Symposium on Environmentally Conscious Design and Inverse manufacturing" Tokyo, Japan 1999

Date

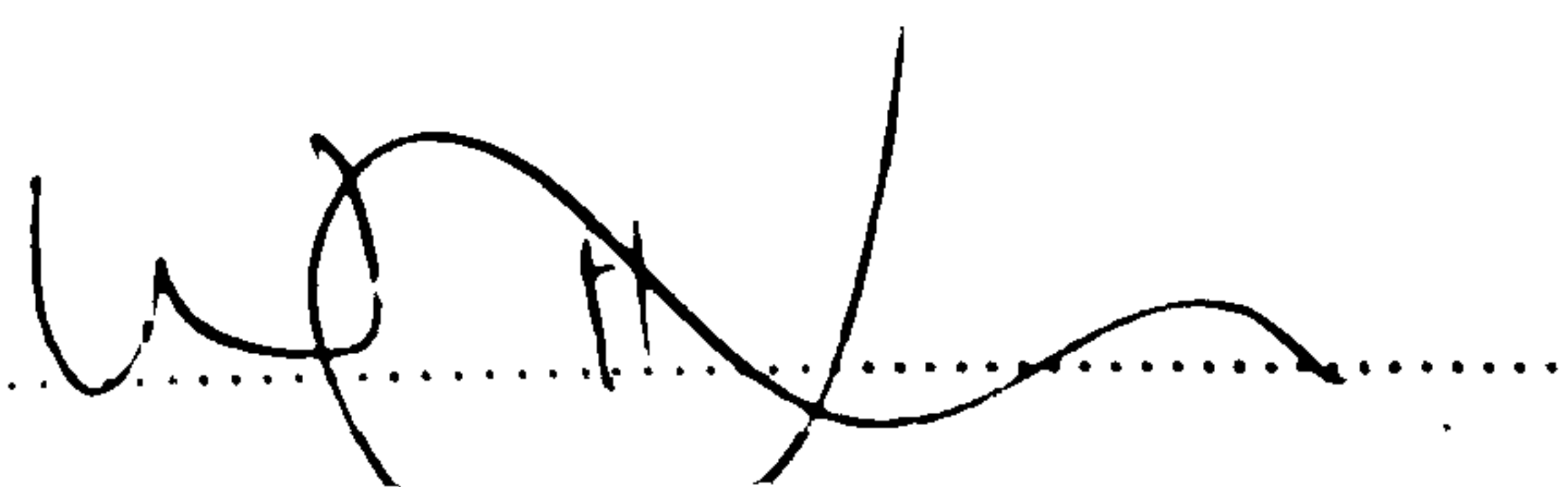

Signed

18/10/2002

Glossary

Build

Build describes the assembly or reassembly of components to obtain the remanufactured product or sub-product.

Rebuilding

Rebuilding is the undertaking of work on a product or component. Bringing an undersized shaft back to the required dimension by metal spraying would be described as the rebuilding of that shaft. Extreme examples of rebuilding include reconditioning, remanufacturing and repairing because they return the used product to the required specification.

Reclaiming

Reclaiming describes the prevention of a used product or component from becoming waste. Thus all operations such as remanufacturing, reconditioning and repairing are reclaiming operations because they return used products to a condition that allows their reuse.

Refurbishing.

Refurbishing is used to describe the rebuilding of a used product or component back to a range of satisfactory working condition. The working condition may be below the original specification depending on the customer's requirement. Extreme examples of refurbishing include repairing and reconditioning and even remanufacturing.

Reverse engineering

Reverse engineering refers to the situation where a remanufacturer analyses a correctly functioning product to obtain information with which to rebuild it to the required specification on its failure. Remanufacturers resort to reverse engineering when Original

Equipment manufacturers (OEMs) refuse them the product information that they need to rectify used products.

The contract remanufacturer

Contract remanufacturers operate under licence to original equipment manufacturers (OEMs). The requirements and obligations of the contract depend on agreements between the parties involved. For example, some contract remanufacturers can undertake some simple redesign of the OEM product. Others may substantially limit costs by having the OEM train their personnel in the more difficult aspects of remanufacturing or fund in-house design and development of remanufacturing equipment. However, they will have restrictions placed on them by the OEM company. These may include having to use only the OEM's genuine spares (parts) for the remanufacturing operation. They must also allow the OEM to evaluate their processes and product quality frequently and sometimes at short notice.

The non-contract remanufacturer

The non-contract remanufacturer is independent of the OEM manufacturer. Such remanufacturers acquire used products that they did not design, build or develop themselves and remanufacture these for resale. These independent remanufacturers often experience great difficulty in obtaining the design information that they require to undertake remanufacturing because OEMs regard them as potential competitors and therefore withhold information from them.

Original Equipment manufacturers (OEMs)

OEMs is a term that describes the companies that design and develop products. Some such companies may also remanufacture those products at the end of their life. Many OEMs regard remanufacturers as competitors and withhold product information from them as a

means of prohibiting the remanufacturing of their used products. Other OEMs may chose to form contracts with remanufacturers. This allows them to easily keep control of their brand name and collect valuable design information.

Intellectual property rights restriction (IPR) problems

(IPR) problems describes the set of problems that non-contract remanufacturers experience because OEMs are often unwilling to release product information to them. These include inability to undertake some remanufacturing jobs because the design information required to undertake the jobs is unavailable to them.

Chapter 1: Introduction

1.1 Introduction

As early as 1935 geologists noted that since the beginning of the last century the world has exploited more of its mineral resources than in all preceding history (Vandermerwe and Oliff, 1991). It is estimated that 4 billion tons of primary metals were used for production between 1900 and 1950, but that 5.8 billion tons of metals were used between 1980 and 1990 alone. Many kinds of metals are used for manufacturing, but most of the rare metals are discarded at the end of a product's life without any form of reuse.

Because the world's waste has grown exponentially each year from the 1950s onwards, disposal methods such as landfills are becoming increasingly expensive as they are being exhausted. The issue of scarcity and therefore high costs of raw materials and landfills has prompted the rise of organisations that aim to link economic growth and ecological concerns.

Such organisations follow sustainable development ethics, which believe that excessive plundering of the earth's resources will alter the balance of the earth's ecological system to the extent that it will become unable to support life. The two general components to sustainability are; living within the critical limits of the ecosystem and balancing social, economic and ecological goals (Yamamoto, 1999). Industries considering the adoption of sustainable development principles include agriculture, architecture and manufacturing (Hormozi, 1996).

Manufacturing generates about 60 % of all non-hazardous waste per year (Nasr and Varel, 1994). In this area, asset and product recovery management (A&PRM) is being used for

addressing the issues of sustainable development. Product recovery processes are forms of A&PRM that can be used to address consumer, economic, and environmental concerns (Hormozi, 1996). Product recovery processes are defined as industrial operations that reclaim whole products or their component parts for reuse in the production process and include repair, reconditioning, and remanufacturing.

This research acknowledges the importance of remanufacturing to sustainable development, but it has sought to understand remanufacturing as a business process in contrast to most earlier work that has investigated it largely from design and ecological perspectives only.

This initial chapter gives a brief overview of this thesis. This involves:

- Introducing the remanufacturing concept.
- Outlining the economic importance of remanufacturing
- Stating some key remanufacturing problems
- Briefly explaining the significance of the research
- Identifying the domain of the research
- Outlining the objectives of the research.
- Explaining the research questions.
- Stating the deliverables, originality and beneficiaries of the research.
- Explaining the research methodology.
- Describing the structure of the thesis.

1.2 The remanufacturing concept

Remanufacturing is the process of bringing used products (called cores) to “like-new” functional state by rebuilding and replacing their component parts (Haynesworth and Lyons

(1987)). The practice is particularly applicable to complex electro-mechanical and mechanical products which have cores that, when recovered, will have value added to them which is high relative both to their market value and to their original cost (Lund, 1984).

1.3 The significance of remanufacturing

Remanufacturing is important because researchers including Ferrer (1996), Hormozi (1996), Ayres et al (1997), Guide (1999), Lund (1996), and McCaskey (1994) have shown that it is an economically significant industrial activity. Although the industry's scope in the UK has not been analysed, research by Guide has revealed that there are in excess of 73,000 remanufacturing companies in the USA alone and that their combined sales exceed \$53 billion per year. Haynesworth and Lyons (1987) proposes that remanufacturing can obtain such economic benefits because its concept is to reclaim old components and use these in the production process. According to researchers such as McMaster (1989), Guide, (1999) and Lund (1984) this reduces the quantity of new material and the level of processing involved in production so that production costs are lower in comparison to conventional manufacturing.

1.4 Some key remanufacturing problems

Researchers such as Melissen and Schippers (1999), Ferrer (1997), and Nasre and Varel (1997) propose that remanufacturing is poorly researched and misunderstood. The key problems they identified include the insufficiency of remanufacturing knowledge leading to, for example, its confusion with the alternative product recovery operations of repair and reconditioning. They also state that there are problems associated with the scarcity of remanufacturing-specific tools and techniques as well as the insufficiency of remanufacturing research and publications. These research and the problems that they identify are dealt with in more depth in chapter 2.

1.5 The significance of the research

This research is significant because it has addressed the major remanufacturing problems. For example, obtaining a robust and unambiguous definition of remanufacturing helps to resolve problems, such as the insufficiency of remanufacturing research, that result from the shortcomings of current definitions of remanufacturing. This would allow academics to conduct valid remanufacturing research, as they would understand remanufacturing explicitly, and will be able to correctly disseminate their findings. Also, by developing a generic and comprehensive model of remanufacturing, that can be used to analyse remanufacturing operations, this research will allow the resolution of the inadequacy of remanufacturing-specific tools and techniques. These developments could be used to help to improve the efficiency and effectiveness of remanufacturing operations, as well as the inadequacy of remanufacturing knowledge.

1.6 The domain of the research

The research lies in the domain of Production and Operations Management (POM) because of the reasons given in section 3.6.2 and the phenomenon being investigated is the mechanical and electromechanical sector of the UK remanufacturing industry.

1.7 Objective of the research

The aim of this research was to address the key remanufacturing problems that were detailed in section 1.4. This involved achieving the following objectives:

1. Unambiguously defining remanufacturing.
2. Developing a standard flow-chart of the remanufacturing operation.
3. Identifying the key problems of the remanufacturing operation.
4. Validating the research findings.

5. Articulating the findings in a format that remanufacturers and academics can use easily.

1.8 Research question

The major research questions answered to satisfy the objectives of this research were:

- What is remanufacturing?
- How is remanufacturing undertaken?
- What are the key problems of the remanufacturing operation?
- Is the new knowledge valid and useful?

For this research the validity issue was particularly important because there was an inadequate body of literature to compare the authors results against. Hence the research was designed to include rigorous testing of research evidence and findings.

- How can the new knowledge be made useful to others?

1.8.1 What is remanufacturing?

This question was key to the research, because successfully answering it permitted remanufacturing to be differentiated from repair and reconditioning, and thereby paved the way for remanufacturing problems to be effectively addressed. To answer this initial question, the author investigated the remanufacturing operation through literature survey, and observation of remanufacturing companies supported by interviews with key company personnel. The unambiguous definition is presented in chapter 7 where it is also compared with repair and reconditioning.

1.8.2 How is remanufacturing undertaken?

It was important to answer this question s in order to provide information with which to illustrate how the remanufacturing operation functions. Answering this question involved the

author observing remanufacturing operations at first hand and also interviewing remanufacturing practitioners to obtain a list of company-specific flow charts of the remanufacturing operation. These flow charts were then compared so that similarities between the operations could be drawn out and used to develop generic flow charts. Two generic flow charts were obtained, one for contract remanufactures and another for independent (non-contract) remanufacturers. These generic flow charts are presented in figure 6.7 in chapter 6.

1.8.3 What are the key problems of the remanufacturing operation?

It was necessary to answer this question in order to identify the causes of inefficiency and ineffectiveness in remanufacturing operations so that effort could be focussed on them.

Here valid answers were obtained mainly by observing remanufacturing operations and discussing them with practitioners. This was critical in order to obtain information that was valid to the research domain and thereby ensure that the results would be firstly, valid to them and, secondly, address their most pressing needs.

1.8.4 How can the new knowledge be made useful to others?

This question was important in order to ensure that new knowledge obtained from the research was presented in a format that both academics and remanufacturers could manipulate to solve their remanufacturing-related problems. This involved identifying a method that could be used to effectively articulate complex information, but that would also be comprehensible and easily accessible to remanufacturers and academics. This led to the development of a robust model of the remanufacturing business process. Because the model displays the resource required in all areas of the remanufacturing business process it can be used as an analytic remanufacturing-specific tool for improving the efficiency and effectiveness of remanufacturing operations. This model addressed the need for a

remanufacturing-specific tool. Also, because the model is easy to understand and use practitioners would be able to manipulate it to improve the performance of their operations

1.8.5 Is the new knowledge valid and useful?

It was important to answer this question in order ascertain whether the research had succeeded in obtaining correct results that would be useful to practitioners. This question was answered by having a carefully selected panel of practitioners use the “validation by review” method (Landry *et al.* 1983) to assess whether the model satisfied the “The needs of practitioners” (Thomas and Tymon, 1982). The validating criteria were the usefulness, sufficiency and clarity of the model. The usefulness of the research findings is illustrated by its ability to help academics and practitioners in the ways indicated in the beneficiaries of the research in section 1.10.

1.9 The deliverable and originality of the research

The principal deliverables of the research were:

1. A flow chart of the remanufacturing operation.
2. A robust and unambiguous definition of remanufacturing.
3. A comprehensive generic model of the remanufacturing business process.

The research is original because the literature indicates that it is the first time that:

1. Remanufacturing has been analysed from a business process perspective because earlier research has largely examined it from an engineering design and ecological viewpoint. This permits it to be recognised as a unique business process with great economic significance, and with problems that require specific solutions.

2. A robust and unambiguous definition of remanufacturing has been determined, which for the first time allows that process to be differentiated from repair and reconditioning, and thereby help to alleviate confusion between secondary market operations.
3. A comprehensive model of the generic remanufacturing business process has been developed. The model is also an analytical tool that can be applied to solve problems that are unique to remanufacturing and so help to resolve the problems associated with the scarcity of remanufacturing-specific tools and techniques.
4. It is the first time that a standard flow chart for the remanufacturing operation has been determined.
5. The research has determined that there are two standard remanufacturing flow charts. One for remanufacturers that have contracts and another for independent remanufacturers (those without contracts).
6. The “investigate core” sub process has been identified as a critical element of the remanufacturing process.
7. The processes of assessing the suitability of components for reuse, the “assess component” activity has been identified as the complicating factor in core investigation.

1.10 The beneficiaries of the research

The main beneficiaries of the research are industry and academia.

In the case of academia, current remanufacturing research and literature is insufficient and inadequate. This is said to result from the scarcity of analytic models of remanufacturing (Guide and Gupta 1999) and the ambiguity in the definitions of product recovery processes such as remanufacturing (Mellissen and Schippers, 1999).

The robust definition of remanufacturing would help to alleviate the confusion in the definitions of secondary market operations because it would permit unambiguous description of remanufacturing for the first time. This would enable researchers to correctly understand remanufacturing so that they could undertake effective remanufacturing research and also clearly and explicitly describe and disseminate their findings. Also, the comprehensive model of the remanufacturing business process is a tool that could be used to analyse and describe remanufacturing operations and businesses so that they can be better understood. These developments could help to address the inadequacy of remanufacturing knowledge.

In the case of industry, practitioners require remanufacturing-specific tools because they believe that the scarcity of effective remanufacturing tools and the shortcomings of remanufacturing research are key threats to their industry. These issues are described through the work of researchers such as Guide and Srivastava 1999c; Mellissen and Schippers, 1999; Weindahl and Burkner, 1999; Farley and Fourcaud, 1992; Guide, 1999; Whybark and Ferrer, 2000 that are presented in chapter 2.

The model displays the resources required in the sub processes of the remanufacturing business process, including the remanufacturing operation. This could help to alleviate the ignorance and confusion surrounding the practice of remanufacturing, so that remanufacturing expertise could be enhanced. When used as an analysis tool it could help remanufacturers to improve their operations and to easily design effective and efficient remanufacturing operations.

1.11 Methodology

The design of this research is based on the qualitative paradigm. A multiple case study

approach was selected and Eisenhardt's (1989) case study theory building framework was used as an effective structure for undertaking the tasks specified in the research design. The eight activities of Eisenhardt (1989) methodology are; getting started, selecting cases, crafting instruments and protocol, entering the field, analysing data, shaping hypothesis, unfolding literature and reaching closure. The main reason for using the Eisenhardt framework was that it is a user-based research mechanism and therefore is highly likely to obtain findings that truly address the needs of remanufacturing practitioners.

1.12 The structure of the thesis

The structure of the thesis is illustrated in figure 1.1. The contents of its eleven chapters are described below.

Chapter 1 provides a brief overview of the research. It presents the reasons for undertaking the research as well as its beneficiaries, originality and contribution to knowledge.

Chapter 2 provides the background to the research. It presents information about the remanufacturing concept and the remanufacturing industry. This involves stating the working definition of remanufacturing, outlining the origins of the remanufacturing concept and describing some characteristics of the remanufacturing industry. Also, it uses the literature to illustrate the significance of remanufacturing in terms of its ability to obtain profits for the producer. Additionally, it examines the scope of current remanufacturing knowledge and uses the literature to identify gaps in remanufacturing research and thereby explain the case for the research.

Chapter 3 is concerned with the design of the research and discusses the philosophical paradigm upon which it is based. It explains the rationale for the choice of research methods

and the research methodology. Also, it describes how the selected research methods were used as well as the measures taken to ensure the validity of research findings.

Chapter 4 describes the Phase 1 case studies and presents their overall structure. Also, it presents each individual case and their conclusions. The Phase 1 case studies were the series of one-day observational studies that studied the remanufacturing operation to define remanufacturing.

Chapter 5 is concerned with the combined conclusions of the Phase 1 cases and describes the current remanufacturing practices that they revealed. This includes the flow chart of the remanufacturing operation that the author has developed. This chapter also describes the characteristics of typical remanufacturing operations and explains their primary production control issues.

Chapter 6 is concerned with the Phase 2 case studies which are the in depth studies that were used to validate the Phase 1 findings. It provides the overall structure of these case studies and presents the individual cases.

Chapter 7 presents the author's new robust definition of remanufacturing that will allow remanufacturing to be distinguished from repair and reconditioning for the first time. This involves explaining the new definition by comparing remanufacturing with repair and reconditioning. It highlights the differences in quality standards between products obtained from these alternative secondary market operations by placing them on a hierarchy based on the performance of their products as well as the work content that they require.

Chapter 8 uses the literature and personal experience to explain the rationale for using the IDEF0 technique to model the remanufacturing business process. IDEF0 is a process modelling technique that provides a picture of the activities and flows of a process or system (Smart *et al.* 1995).

Chapter 9 is concerned with the building of the generic model. It explains the modelling of the remanufacturing business process using the IDEF0 technique. This involves describing the Phase 3 case study. During the Phase 3 case study a company-specific model was developed for use as a foundation for developing the generic model of the remanufacturing business process. This chapter also explains the usefulness of the model.

Figure 1.1: The structure of the thesis

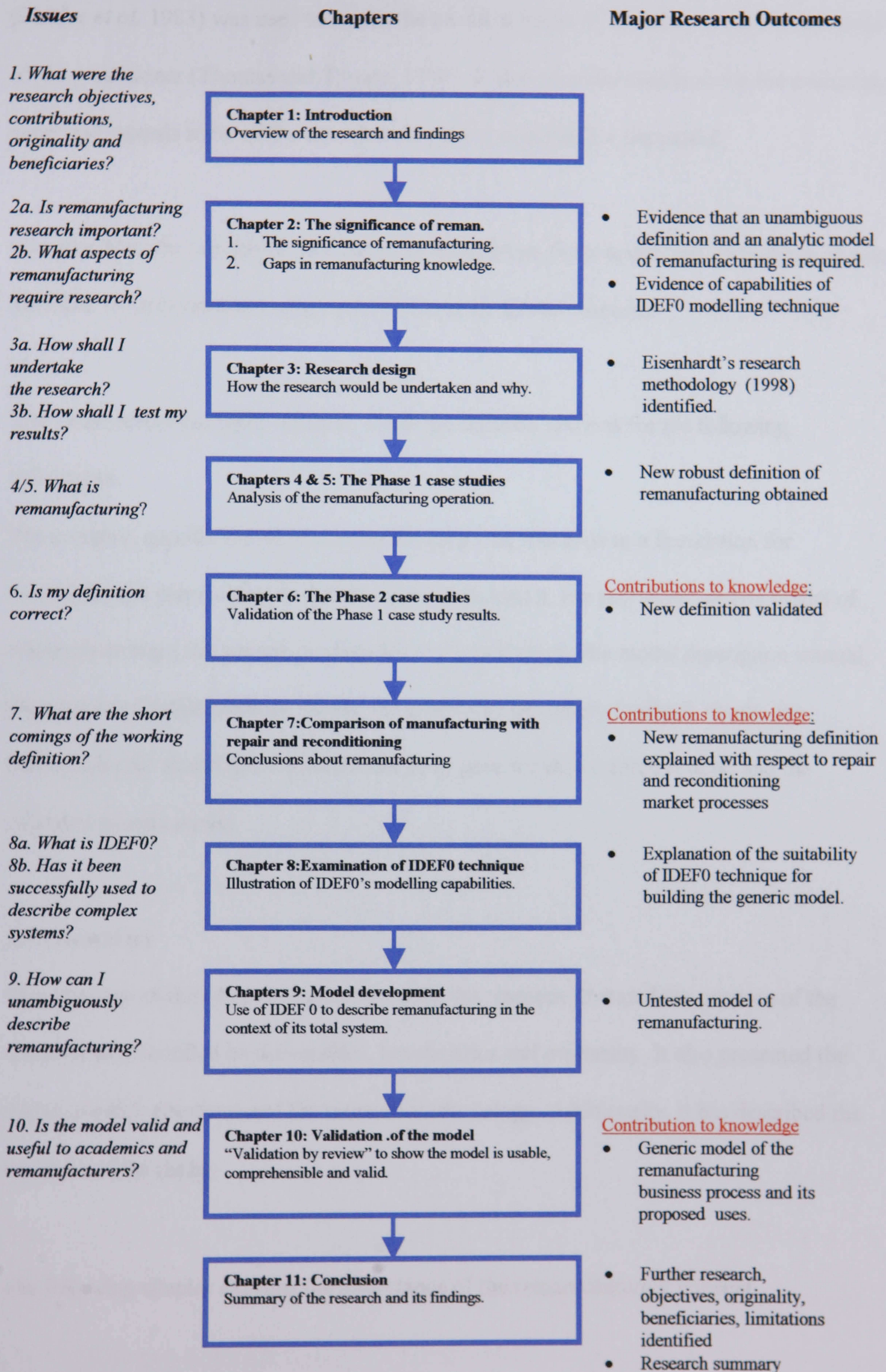

Chapter 10 describes the validation of the model. The “validation by review” method (Landry *et al.* 1983) was used to assess the model in terms of its ability to satisfy the needs of the practitioner (Thomas and Tymon, 1982). It also provides details about the evaluating panel and records some of the uses that they have proposed for the model.

Chapter 11 is the conclusion and therefore summarises the research and its findings. It also identifies some remanufacturing issues that require further research.

The Appendices has eight sections. There are separate sections for the following information:

The company specific model of remanufacturing that was used as a foundation for developing the generic model, IDEF0 information leaflet, the prototype generic model of remanufacturing (the generic model prior to its validation), the model description manual, the completed initial feedback sheets, the completed secondary feedback sheets, the Biffawards (the award that a government body gave for the research results) and the validated generic model.

1.13 Summary

The objective of this chapter was to introduce the research. It stated the purpose of the research and identified its deliverables, beneficiaries and originality. It also presented the major research questions and the research methodology. Additionally, it has described the structure of the thesis.

The following chapter explains the importance of the remanufacturing concept.

Chapter 2: The significance of remanufacturing

2.1 Introduction: Objectives of the chapter

This chapter sets the context for the research. It provides basic information about the remanufacturing concept. This involves stating the author's working definition of remanufacturing, outlining the origins of the practice and describing some characteristics of the remanufacturing industry. It explains the significance of remanufacturing in terms of its ability to obtain profits for the producer. Also, it examines the extent of current remanufacturing knowledge and identifies gaps in the literature to justify the research.

2.2 The definition of remanufacturing initially adopted by the research

Currently there are many interpretations of the term remanufacturing. Researchers such as Krupp (1992) define remanufacturing as "Refurbish or rebuild". However, refurbish is used to describe a range of operations that are used to reclaim used products including repair and reconditioning. Others, for example Boyer (1992) and Dreckshage (1992) have even questioned the existence of significant differences between remanufacturing and conventional manufacturing.

Haynesworth and Lyons (1987) published one of the first definitions of remanufacturing when they described it as "a process of bringing a product to like-new condition through replacing and rebuilding its component parts". The definition is very similar to that favoured by many of the better-known researchers such as Lund (1984), Amezquita *et al.* (1996) and Guide (1999). The author initially adopts the definition of remanufacturing proposed by Haynesworth and Lyons (1987) as a working definition that may be altered as the research uncovers further information. Later chapters will explain whether the working definition should be amended.

2.2.1 Other remanufacturing-industry definitions used in this thesis

In order to be able to effectively discuss the research with practitioners the author adopted some terms that are commonly used in the remanufacturing industry. These are used often in this thesis and include build, rebuilding, reclaiming, refurbishing and reverse engineering.

With the exception of reverse engineering these terms are used interchangeably within the industry and therefore can apply equally to remanufacturing, reconditioning and repair. This situation illustrates the scale of confusion that exists in the definitions of secondary market operations. The definitions of these terms adopted in this thesis is provided in the Glossary on page 19

2.3 History of remanufacturing

The principle of remanufacturing is not new. In fact many old industries such as the vintage car market have always relied on it. In Britain, for example, J and E Hall Ltd., until recently a member of APV Holdings Group Ltd, was remanufacturing its own compressors at its Dartford site as far back as the 1940s. What is new is the concept of remanufacturing on a mass scale and involving products that the remanufacturer did not originally build.

In the U.S, the first record of remanufacturing by an independent operator is credited to Albert Holzwasser who formed The Arrow Automotive Industries in Boston in 1929 (Haynesworth and Lyons 1987). According to Clegg and Williams (1995) the major cost of producing complex products results from the material and processing resources.

Haynesworth and Lyons (1987) and Lund (1984) among others claim that remanufacturing lowers production costs so that products can be offered to customers at much lower prices in comparison to conventionally manufactured alternatives.

2.4 The remanufacturing industry

The remanufacturing industry can be discussed in terms of the characteristics that make a product remanufacturable, the sectors of the remanufacturing industry and the types of remanufacturer.

2.4.1 Characteristics of remanufacturable product

While conventional manufacturing is relevant to products of any material composition, remanufacturing is applicable only to a subset of durable products. Andreu (1995) gives the following list of the essential characteristics of remanufacturable products:

1. The product has a core that can be the basis of the restored product. A core is the used equipment to be remanufactured.
2. The product is one that fails functionally rather than by dissolution or dissipation.
3. The core is capable of being disassembled and of being restored to original specification.
4. The recoverable value added in the core is high relative to both its market value and its original cost.
5. The product is one that is factory built rather than field assembled.
6. A continuous supply of such cores is available.
7. The product technology is stable.
8. The process technology is stable.

2.4.2 Sectors of the remanufacturing industry

The remanufacturing industry embraces a diverse range of products. According to Petrakis (1993) these fall into four main sectors: industrial, commercial, automotive and domestic products.

The industrial sector is concerned with products that are frequently custom-made such as hydraulic products, heavy-duty diesel engines and process valves. Examples of products from the commercial sector include office machinery, refrigeration compressors, vending machines and communication equipment. The automotive sector is by far the largest sector of the remanufacturing industry. The largest numbers of automotive remanufacturers serve the replacement parts businesses for vehicles. There is a large variation in the complexity of remanufactured products in this sector ranging from motor rewinding to remanufacturing of complete diesel engines. Lund (1984) has stated that the domestic sector is the smallest subgroup and that business in this area is primarily confined to appliances such as power tools and lawn mowers. He explains that consumer prejudice towards used goods has hampered the expansion of this sector of the remanufacturing industry.

2.4.3 Types of remanufacturing practitioners

Lund (1984) has identified three types of remanufacturing practitioners. These are the original equipment manufacturer (OEM), the independent (non-contract) remanufacturer and the contract remanufacturer.

2.4.3.1 The original equipment manufacturer (OEM)

The original equipment manufacturer (OEM) makes and sells both new and remanufactured versions of its own products.

2.4.3.2 The non-contract remanufacturer

Non-contract remanufacturers are independent of the OEM manufacturer. Such remanufacturers acquire used products that they did not design, build or develop and remanufacture these for resale. Lund (1984) states that these independent remanufacturers often experience great difficulty in obtaining the design information that they require to

undertake remanufacturing because OEMs regard them as potential competitors and therefore withhold information from them.

When OEMs refuse to release product information, independent remanufacturers often attempt to obtain required technical information by reverse engineering or by resorting to industrial espionage. In this instance reverse engineering refers to the situation where a remanufacturer analyses a correctly functioning product to obtain information with which to rebuild it to the required specification on its failure. Both of these are poor choices. The former is expensive, time consuming and often ineffective while the latter can result in substantial financial penalties.

2.4.3.3 The contract remanufacturer

These remanufacturers by-pass intellectual property rights restrictions (IPR) by remanufacturing under licence to OEMs. Contract remanufacturers operate very much as an extension of the OEM company and can often substantially limit training costs by having the OEM train their personnel in the more difficult aspects of remanufacturing. The research has identified additional benefits that contract remanufactures enjoy and these are explained in section Chapter 4 for example under “Effects of contracts on level of uncertainty” as detailed in “The author’s observations about Company E”. This issue of the advantages of contracts is also discussed in chapter 5 in Section 5.5.

Research by Lund (1984) has revealed that, although the remanufacturing market is dominated by OEMs and contract remanufacturers, the majority of remanufacturers are independent small-scale operators. The research identified that there are differences in the operations of contract and non-contract remanufacturers. These differences can be appreciated by reading the descriptions of the case studies presented in chapters 4, 5 and 6.

2.5 The major remanufacturing drivers

The major remanufacturing drivers are environmental concerns, legislation and cost reduction (Amezquita *et al.* 1996). Because this research is primarily concerned with exploring remanufacturing as a business process this thesis will not discuss the specifics of the environmental and the legislative remanufacturing drivers but rather refer the interested reader to the extensive literature available in those areas. With regards to the environmental and legislative remanufacturing drivers researchers such as Vandermerwe and Oliff (1991), Yamamoto (1999), Hormozi (1996), Nasre and Varel (1994), Guide (1999), Lund (1996), Lund (1984), Clegg and Williams (1995) and Tullip (1997), have written about the need to reduce waste during production and the benefits of remanufacturing to that cause.

2.6 The cost reducing characteristics of remanufacturing

According to Lund (1996) and others such as Guide (1999), McCaskey (1994), Ferrer (1996), Hormozi (1996) and Haynesworth and Lyons (1987) remanufacturing can obtain significant profits for producers because normally the cost of conventional manufacturing far exceeds that of remanufacturing. Studies by McMaster (1989) for example indicate cost savings in the region of between 20% to 80% as well as quality comparable to that of an equivalent “new” product.

Research by Lund (1984), Haynesworth and Lyons (1987), Guide and Gupta (1999) and Hormozi (1996) among others indicate that the profits obtained through remanufacturing result from its requirement for reduced levels of labour, energy, materials and disposal costs in comparison to conventional manufacturing.

2.6.1 Reduced labour costs

Lund (1984) reports that remanufacturing is labour-intensive and simple to master and therefore creates employment for low to moderately skilled workers. He states that 60% of

the labour force of a typical remanufacturing company is semi-skilled or unskilled and, specifically for the automotive sector, 32% of the workforce is unskilled. These conclusions are supported by the findings of more recent studies. For example, Nasre *et al.* (1998) (in Guide and Gupta, 1999) report that 85% of remanufacturing firms use manual conventional equipment to process material.

The use of low-skilled workers can help to reduce production costs because such employees require less remuneration in comparison to highly skilled labour. This assertion is supported by research evidence. For example, studies by Hormozi (1996) have shown that a remanufactured gasoline engine provides 33% savings in labour costs in comparison to a conventionally manufactured alternative.

2.6.2 Reduced energy costs.

Lund (1984) proposes that the energy required to remanufacture a product is significantly less than that required for conventional manufacturing because remanufacturing can capture much of the energy originally used in making the product. That conclusion is supported by the findings of many other researchers. Hormozi (1996), for example, states that a remanufactured product requires 50% to 80% less energy to produce than a new product and gives the example of remanufactured gasoline engines providing 50% savings in energy costs when compared to conventionally manufactured alternatives.

2.6.3 Reduced materials costs.

Ayres *et al* (1997) report that, in 1995, remanufacturing obtained material cost savings in the region of \$69.4 million for ARO Ltd. Also, researchers such as Lund (1984) and Hormozi (1996) state that remanufacturing obtains these savings because more than 85% of the weight of a remanufactured product is obtained from used components. Lund (1984)

further explains that 12-15% of core weight in material is typically lost during conventional manufacturing and that, when this is taken into account, the ratio of used to new components in a typical remanufactured product may be as high as 9:1 for the more efficient remanufacturers. The use of used products (cores) as a supply of material in production can obtain savings because the cores are inexpensive (see for example Lund, 1984). In fact in some instances remanufacturers can obtain cores free of charge.

2.6.4 Reduced disposal costs.

Research by Nasr and Varel (1994) and Vandermerwe and Oliff (1991) for example, has shown that disposal methods such as landfills are increasingly expensive because available sites are being exhausted. Hormozi (1996) reports that in the USA disposal costs were estimated at \$30 billion in 1992 but were predicted to rise to \$75 billion by the year 2000. Ayres *et al.* (1997) report that disposal costs represent 2% of direct production costs for laser printers, 3% for cars and 12.5 % for refrigerators and freezers.

According to Clegg and Williams (1995) European (EU) regulations already require companies to take back certain types of their waste and it is expected that the range of products covered by these “take back” laws will continue to increase. Ferrer (1996) proposes that if firms become responsible for their used products, remanufacturing can help reduce the financial penalties resulting from this. This is because remanufacturing uses reclaimed components and therefore can provide companies with a profitable avenue for “disposing” of their used products and components. Also, remanufacturing extends the life of products and therefore delays their final disposal.

2.6.5 Examples of the profit and cost savings obtained from remanufacturing.

Hormozi (1996) proposes that remanufacturing can obtain profits in two major ways.

Firstly, the cost of remanufacturing is lower than that of conventional manufacturing so the remanufacturer makes profits from the cost saving obtained. Secondly, the company with a broken product can sell it as a core (used product to be remanufactured) to a remanufacturer, thus generating revenue while simultaneously avoiding disposal costs.

However the profits obtainable from selling cores is substantially less than that of remanufacturing. This is because the price of cores must be low in order to support a viable remanufacturing operation. For example, because the condition of the components of a core cannot be accurately determined prior to its purchase, remanufacturers typically would not purchase cores unless their price was low enough to warrant the risk of obtaining an unusable core.

Studies by Haynsworth and Lyons (1987) and others indicate that remanufacturing has been a viable economic activity for many decades. Many researchers including Hormozi (1996) and Ferrer (1996) have documented the scale of profits obtainable through remanufacturing. For example, Lund (1996) in Guide (1999) has shown that there are more than 73,000 remanufacturing firms in the United States and that the majority of them have annual sales of at least \$21 million while their combined sales exceeds \$53 billion per year. Figure 2.1 illustrates the scale of savings and profits that are typically attributed to remanufacturing.

Table 2.1: Cost savings and profits obtained from remanufacturing

Examples from Haynesworth and Lyons (1987).

1. Customers paying \$ 900,000 plus trade-in of their used engine for remanufactured JT80 jet engine as opposed to \$1.6 million for a new one.
2. United States Machine Tools Ltd. switching from conventional manufacturing to the remanufacturing of machine tools to offer customers between 30% to 60% savings on their “good as new” tools while simultaneously enjoying enhanced profit margins through the 50% increase in custom that it obtained.
3. An automotive components remanufacturer, Arrow Automotive Industries, completing \$100 million worth of business in 1984.

Examples from Hormozi (1996)

1. Xerox obtaining annual savings of \$200 million by using remanufacturing concepts.
2. Remanufacturing of buses at costs ranging from 40% to 60% of new bus prices and
3. The remanufacturing of industrial milling machines for half the price of a new machine.

Example from Ferrer (1996)

1. Photocopy machines typically enjoying a 30% discount over the price of a similar machine made of all new parts.

2.7 Additional benefits from remanufacturing.

Researchers such as Hormozi (1996), Lund (1984), Vandermerwe and Oliff (1991) and Tulip (1997) have documented some additional benefits that remanufacturing offers producers. These include decreased capital investment, shorter production lead times, balancing the changes in business cycles, augmented design and development data and protection of brand name. Vandermerwe and Oliff (1991), Lund (1984), Tulip (1997) and Melissen and Schippers (1999) also report that remanufacturing can help to enhance environmental credentials. The author will not discuss these benefits in this thesis because they are peripheral to this research. However, the interested reader is urged to consult

publications by researchers such as those named in this paragraph for elaboration on these additional remanufacturing benefits.

2.8 A comparison of remanufacturing and related production processes.

Conventional manufacturing, reconditioning, remanufacturing and repair are related in so far as that they are all value adding industrial processes. All four convert material into higher value products and have assembly as a sub-process. The following section examines remanufacturing by comparing it firstly with conventional manufacturing and, secondly, with reconditioning and repair.

2.8.1 Remanufacturing versus conventional manufacturing.

The major distinction between remanufacturing and conventional manufacturing is that remanufacturing uses worn-out, discarded, or defective products as a primary source of material while conventional manufacturing uses newly produced components (Lund, 1984). This factor affects not only the production processes employed but also the contractual relationship with customers, who may also be suppliers. Other differences observed by researchers such as Guide (1999) and Whybark and Ferrer (2000) include testing and inspection methods, the extent of design and development activities, the nature of inventory and the degree of control over the operation.

Guide and Gupta (1999) have compared the testing and inspection needs of remanufacturing and conventional manufacturing. The results of their analysis indicate that in remanufacturing inspection must be rigorous and on a 100% basis because the incoming material, the core, is known to be defective in some way therefore “cores are disassembled to the part level before any decisions may be made about the required processing, or if the part must be replaced”. That is in contrast to manufacturing where sampling plans and

supplier assurance are the norm.

Other researchers for example, Lund (1984) and Andreu (1995) have analysed the extent of design and development activities involved in conventional manufacturing and remanufacturing operations. They state that in general, remanufacturing organisations will engage in little if any design and development work. This is because research by Lund (1984), Haynesworth and Lyons (1987) and Amezquita *et al.* (1996) have shown that remanufacturing rebuilds used products to like-new condition so original specifications are used regardless of any evident design flaws. Manufacturing on the other hand is concerned with design and development either for new product introduction or else to improve existing products. As a result, in comparison to the remanufacturing operation conventional manufacturing involves a much greater degree of design and development activity.

With regards to the nature of inventory, research by Lund (1984) and others have shown that conventional manufacturing inventory is composed only of new component stock while remanufacturing obtains a high proportion of its materials from used products so its inventory stock will consist of both new and old components. Studies by researchers including Guide (1999) as well as Guide and Srivastava (1997b) propose that remanufacturing environments suffer from greater levels of uncertainty than conventional manufacturing. They state that this makes production planning and control more difficult in remanufacturing. For example, Devore (1992) proposes that “while the manufacturer has blueprints and material specifications, remanufacturers must create the bill of materials (BOM) by reverse engineering products with unknown quality levels”. In this instance reverse engineering refers to the situation where a remanufacturer analyses a correctly functioning product to obtain information with which to rebuild it to the required specification on its failure.

The degree of control that the practitioner has over their operation has also been compared for conventional manufacturing and remanufacturing. Many researchers including Lund (1984) state that because of the extreme levels of uncertainty in remanufacturing, the remanufacturer generally has less control over its operation than the manufacturer. The list of causes of uncertainty in remanufacturing published by researchers such as Guide and Srivastava (1997b), Guide (1999), Whybark and Ferrer (2000) include variability in demand volume, core quality, core availability, variety in product type and availability of technical knowledge. For example, remanufacturers typically accept all orders and cores offered but, because of the high variety of product types, until cores are disassembled, it is never certain whether there are appropriate resources to fulfil orders. Also, OEMs (original equipment manufacturers) can create barriers to remanufacturing by refusing to sell replacement parts to remanufacturers and by withholding the design and specification information that they require to remanufacture (Lund, 1984). Guide and Gupta(1999), Guide and Srivastava (1997b) among others state that such extreme uncertainty has significant implications for scheduling, capacity planning and shop-floor control.

2.8.2 Remanufacture versus reconditioning and repair.

Remanufacturing, repair and reconditioning can all be described as product recovery processes (see for example Melissen and Schippers, 1999). They share similar processing structures including disassembly, test, rebuild and reassembly and according to Wiendahl and Burkner (1999) have disassembly as an essential and initial activity.

Table 2.1 presents the definitions of the three processes proposed by Amezquita *et al.* (1996). It can be seen from this table that only remanufacturing is required to bring used products to “like new” condition while repairing and reconditioning only need to get the product “up and running” again.

Table 2.2: Process Definitions (Amezquita *et al.* (1996))

Process	Definition
Remanufacture	Process of bringing a product to like-new condition through replacing, reusing and reconditioning component parts.
Repair	Process of bringing a damaged product back to a functional condition.
Reconditioning	Process of restoring a product to a functional/and or satisfactory state using such methods as resurfacing, repainting, sleeving, etc.

2.9 Existing research in remanufacturing.

The author's literature survey has shown that remanufacturing-related research falls into two groups. These are research concerned with the implication of remanufacturing for product design (Ecodesign) and studies that consider methods for improving the efficiency and effectiveness of remanufacturing operations (remanufacturing-specific research).

2.9.1 Ecodesign.

Research in ecodesign is concerned with designing products for ease of after-life manipulation. The main thrust of such work has been to minimise the resource required to disassemble products at the end of their lifecycles, for example by reducing and simplifying connection methods. This body of research is not specifically geared towards remanufacturing but rather at the various production processes that use components from used products. According to Wiendahl and Burkner (1999) such processes are referred to as secondary market processes, general re-use processes, disassembly processes or product recovery processes (see for example Mellissen and Schippers, 1999) and include repair and reconditioning as well as remanufacturing. Because of the similarities between such

processes remanufacturing can benefit from some of the issues addressed by ecodesign research.

For example disassembly is an essential activity of the remanufacturing operation (Wiendahl and Burkner, 1999) and many products cannot be economically remanufactured because of the excessive resource required to disassemble them. By reducing the resource required to disassemble products the methodologies developed through ecodesign research can help to increase the quantity of remanufacturable products in the future. Work in this area has been extensively documented by researchers such as, Ishii and Lee (1996), Chiodo (1999), Chiodo (1999b), Chiodo and Goldberg (1998), Berry (1996) and Amezcua *et al.* (1996). Because this research is solely concerned with the process of rather than the context of remanufacturing, this thesis will not elaborate on the specifics of ecodesign. However, the interested reader is encouraged to refer to the work of the researchers mentioned earlier in this paragraph for additional information on that subject.

2.9.2 Remanufacturing specific research.

Remanufacturing-specific research falls into two main groups, examination of remanufacturing practice and studies to develop methods for improving the efficiency of remanufacturing operations.

2.9.2.1 Examination of remanufacturing practice.

Lund (1984) undertook the first and most comprehensive analysis of remanufacturing. That research examined the scope of remanufacturing in terms of the range of products covered and the types of remanufacturing practitioner. Also, it identified the benefits of remanufacturing in both environmental and economic terms and documented its benefits to the developed countries, in particular to the U.S.A, as well as its advantages to the Third

World. It also identified one of the barriers to the expansion of the remanufacturing market as consumer prejudice towards used goods coupled with their inability to differentiate between remanufactured products and products from related secondary market production processes.

The information obtained by that work has been augmented in recent years. Guide and Srivastava (1999) for example, undertook a comparative evaluation of remanufacturing and repair operations. The study determined that remanufacturing differs from repair and that one of the most important differentiating characteristics between the two processes was the requirement of remanufacturing for a higher degree of work content in comparison to repair operations. Guide and Gupta (1999) examined the difficulties of developing models for studying remanufacturing operations. Lund for his part supplemented his earlier work by investigating the number of companies involved in remanufacturing and remanufacturing-related processes in the U.S.A as well as their contribution to the USA economy (see for example Lund, 1996 and Lund, 1998 in Guide, 1999).

2.9.2.2 Research to improve the efficiency of remanufacturing operations.

Research to improve the efficiency of remanufacturing operations can be divided into three main groups. These are the examination of the sufficiency of current remanufacturing knowledge, the development of tools and techniques for remanufacturing and the assessment of the adequacy of current remanufacturing tools and techniques.

With regards to the examination of the sufficiency of current remanufacturing knowledge, the paucity of current remanufacturing knowledge is an issue that has been noted by many researchers. Nasre and Varel (1997) for example, conclude that remanufacturing is a misunderstood and poorly researched production process. Two key issues here are the

ambiguity of current definitions of remanufacturing, (Ferrer, 1997), and the scarcity of published research on remanufacturing, (Melissen and Schippers, 1999).

The sufficiency of remanufacturing definitions has been analysed by researchers. Melissen and Schippers (1999) report that a variety of expressions are used to describe different recovery activities because the field of recovery processes is a relatively new and unexplored area (refer also to Ferrer, 1997 and Lund, 1984). The conclusion of Melissen and Schippers (1999) is that the field of recovery processes urgently requires further research to develop tools specifically for them and also to define and distinguish between different recovery processes.

Other researchers have assessed the extent of remanufacturing research. For example, Guide (1999) proposes that a detailed analysis of all the operational aspects of remanufacturing is required because present research has failed to address many issues that are important to successfully plan and control remanufacturing operations. Research by Melissen and Schippers (1999) concluded that companies find remanufacturing problematic because the literature gives them little support in setting up effective and efficient operations and that generally current quality practice in remanufacturing-like environments is mainly detection oriented. They propose that addressing this problem will require introducing control systems using experience and knowledge gained from such environments.

The author's literature survey revealed that current research to develop remanufacturing tools and techniques is generally concerned with planning and control. One of the reasons for this is that Wiendahl and Burkner (1999) have shown that effective planning and control can greatly increase the profitability of processes that involve disassembly because it improves information, supports decision making and minimises non-value-added work.

Because many researchers agree with Deckshage (1992) and Boyer (1992) that remanufacturing is very similar to any other manufacturing business, the main thrust of studies to develop remanufacturing tools has been to adapt the tools of conventional manufacturing to the remanufacturing environment. Bothe (1992) for example, contends that statistical process control (SPC) can be adapted for remanufacturing operations. The areas of the remanufacturing operations for which the tools of conventional manufacturing have been adapted include performance measurement and scheduling. Notable research in performance measurement for remanufacturing environments include Boyer (1996), Ptack (1996) and Pool (1992). With regards to scheduling researchers such as Turek and Hansford (1992), Farley and Fourcaud (1992) and Boyer (1992) have addressed the use of manufacturing resource planning (MRP) to assist remanufacturing.

The third method that researchers have used to try and improve the efficiency of remanufacturing operations is to assess the adequacy of current remanufacturing tools and techniques. Here notable research includes Farley and Fourcaud (1992), Guide (1999), Nasre *et al.* (1998), Guide and Gupta (1999), Melissen and Schippers (1999), Wiendahl and Burkner (1999), Guide and Srivastava (1997b) and Whybark and Ferrer (2000).

The studies can be divided into two main groups. These are research to determine whether the tools of conventional manufacturing are appropriate for the remanufacturing environment and work to judge whether remanufacturing and repair require similar production planning and control systems.

With regards to comparing the production planning and control needs of remanufacturing with that of conventional manufacturing Guide (1999), for example, concludes that remanufacturing would benefit from the development of remanufacturing-specific tools and

techniques because such firms must manage complex tasks that are significantly different from those of traditional manufacturing. In fact, 60% of the remanufacturing executives polled in that research identified the greatest threat to industry growth as the increased pressure to continuously reduce remanufacturing lead times while 30% cited the lack of formal systems for managing their businesses. This is in agreement with the findings of Guide and Gupta (1999) who report that a number of models of various aspects of remanufacturing systems have been reported in the literature but that none were analytic models. They propose that this is due to the complex nature of remanufacturing added to the lack of detailed studies of relatively simple systems for managing remanufacturing operations.

As far as comparing the production planning and control needs of remanufacturing to that of alternative secondary market processes is concerned, Guide and Srivastava (1999), for example, evaluated whether repair and remanufacturing operations could be performed with the same production planning and control systems. The research concludes that the level of dissimilarity between the processes demands their use of different systems. The issue of the need for remanufacturing-specific tools to enhance the effectiveness and efficiency of remanufacturing operations is a theme that has been aired by many researchers. Farley and Fourcaud (1992) for example, propose that the benefits of concurrent development concepts are particularly applicable to the repair and remanufacturing environment because of the scarcity of commercially available MRP II software that supports them. Also, Melissen and Schipper (1999) report that there is urgent need for research to develop tools for remanufacturing-like processes.

2.10 The case for the research

The author's literature survey, presented in the previous paragraphs, has identified two key remanufacturing issues. These are the inadequacy of remanufacturing knowledge, for example the shortcomings of current definitions of remanufacturing and the lack of models for analysing remanufacturing operations.

This research is significant because its objective is to address these issues firstly, by determining an unambiguous definition of remanufacturing and, secondly, by developing a robust model of the remanufacturing business process.

An unambiguous definition of remanufacturing is required because Lund (1984) has shown that one of the biggest obstacles to the growth of remanufacturing in some product sectors is consumer prejudice against used products coupled with their inability to differentiate between remanufacturing and related secondary market processes.

Also, researchers such as Guide (1999) have documented that remanufacturing practitioners perceive the scarcity of effective remanufacturing tools as a key threat to their industry and that this situation is caused by the shortcomings of remanufacturing research. This is in agreement with the conclusion of Nasre and Varel (1997) that remanufacturing is a misunderstood and poorly researched production process. At the same time, Mellissen and Schippers (1999) report that currently, it is extremely difficult to undertake remanufacturing research and also to disseminate remanufacturing knowledge because of the confusion in the definition of remanufacturing and that of other secondary market processes.

The unambiguous definition of remanufacturing developed through this research would help to resolve these problems. This is because it would enhance remanufacturing knowledge

because it would for the first time permit remanufacturing to be explicitly differentiated from repair and reconditioning. This development would help to improve the effectiveness of the dissemination of remanufacturing knowledge. It would also help to pave the way for productive research into remanufacturing operations so that appropriate tools and techniques can be developed specifically for them.

The second research objective is to use the new definition as a foundation for building a comprehensive model of the remanufacturing business process. A robust model of the remanufacturing business process is required because research by Guide and Srivastava (1997) among others has shown that currently, there are no analytic models of remanufacturing. However, according to many researchers such as Kubeck (1997) and Wang *et al.* (1993) models are proven methods of conveying information. For example, Mertins *et al.* (1996) recommend modelling for analysing business processes because they can overcome communication problems such as ambiguity that are associated with conversational languages. Also, Ould (1995) states that business process modelling is useful where “there is a need for a shared understanding of what the business does and also where information is required to assist improvement change programs”. Refer also to Smart *et al.* (1995), and Bennett *et al.* (1995) who report that their use of the IDEF0 process modelling technique to develop business process models helped companies to improve their understanding of their processes so that improvements could be determined and implemented.

A robust model of the remanufacturing business process would comprehensively display the resource required in all areas of the remanufacturing business process and as a result may be used as a tool for planning and controlling remanufacturing operations. The key advantage of the model would be that it could be used to help to design and implement effective and

efficient remanufacturing businesses as well as to improve the efficiency and effectiveness of existing remanufacturing operations.

2.11 Summary

This chapter has set the context of the research by presenting essential information about the remanufacturing concept and the remanufacturing industry. This involved explaining the economic significance of remanufacturing in terms of its ability to obtain profits for the remanufacturer. It has detailed the main remanufacturing drivers and it has discussed the sources of savings obtained through remanufacturing. Also, it has examined the extent of remanufacturing research and used the literature to illustrate the need for a robust and unambiguous definition of remanufacturing as well as a comprehensive model of the remanufacturing business process. The following chapter describes the research design.

Chapter 3: The research design

3.1 Introduction

The previous chapter explained the significance of remanufacturing and the need for the research. This chapter discusses the research design. It describes the remanufacturing operation as a type of human activity system (HAS) known as a business process, (Davenport and Short, 1990). It explains the choice of research methods and tools and describes the research methodology.

3.2 The philosophical paradigm and research design

The two major paradigms that are the basis of research design are the qualitative and quantitative paradigms and these have their roots in the philosophical thinking of phenomenology and positivism respectively (Easterby-Smith *et al.* 1993 and Creswell, 1994). Gummesson (1993) proposes that phenomenology and positivism have five distinguishing assumptions, (ontology, epistemology, axiology, rhetoric and methodology), that impact on research design.

3.2.1 Ontology

Ontology is concerned with the nature of reality (Creswell, 1994 and Gummesson, 1993). Because of this the perspective on ontology taken by a particular paradigm will determine what is fact and, therefore, what type of information must be collected and how. The ontological assumption will also determine how data is analysed and to some degree how results are presented. For this reason the validity of research findings can be assessed by the researcher's ability to demonstrate that the information gathered (i.e. the reality consulted) to obtain those findings are consistent with the view of reality (the ontology) supported by the philosophical stance of the research design. Gummesson (1993) states that quantitative

research takes a positivist outlook where reality is seen as objective and independent of the researcher. Here, only data with primary qualities (i.e. non-subjective data) are gathered to obtain knowledge. Qualitative research, on the other hand, has a phenomenological outlook and here it is assumed that reality is subjective and constructed by the individuals involved in the research. In this case the term “the individuals involved in the research” refers to the researcher and those being researched. Creswell (1993) proposes that with the qualitative paradigm, each one of these individuals will have their own interpretation of the situation. He further proposes that because all of these perceptions of reality are equally valid in the phenomenological stance they must all be considered to obtain valid results in qualitative research.

3.2.2 Epistemology

Creswell (1993) and Meredith *et al.* (1998) propose that epistemology is concerned with the nature of knowledge and the things that can be known. It therefore determines the relationship between the researcher and those being researched because close involvement will influence the researcher and vice versa. The quantitative paradigm believes that knowledge should be obtained using proven rules and logical reasoning. As a result, in quantitative research, the researcher remains distant and independent of those being researched because in such situations the evidence is more likely to be assessed objectively. Qualitative research, on the other hand, requires the researcher to interact with those being researched. The reason here is that such circumstances would permit the researcher to more easily obtain understanding from the subjective and objective opinions of those being researched as well to develop his or her own perceptions of the reality being investigated.

3.2.3 Axiology

According to Creswell (1993) axiology is concerned with the role of values in the research.

In the case of quantitative research, the researcher's values are kept out of the study in order to maintain the integrity of research information. In contrast, the qualitative researcher admits the value-laden nature of the research and reports his or her own biases as far as possible as well as those of the researched.

3.2.4 Rhetoric

Creswell (1994) proposes that rhetoric refers to the language of the research.

Quantitative research measures objective data. Because these are precise and concepts and variables are well defined, it uses impersonal and formal language based on accepted conventions. As a result quantitative research findings can often be expressed mathematically.

In the case of qualitative research data is subjective and may have different values for different individuals. As a result the language of qualitative research may be informal and personal and subjective terms such as “understanding”, “discover” and “meaning” are used. Because of this the findings of qualitative research cannot be explained using mathematical laws, but the rich data obtained can be used to build diagrammatic and verbal images that can help to enhance understanding.

3.2.5 Methodology

Methodology describes the research process. Easterby-Smith *et al.* (1993) state that the purpose of research methodology is to act as an effective structure for undertaking the tasks specified in the research design. Creswell (1994) propose that the methodology must complement the philosophical assumptions of the paradigm upon which the research design is based. In quantitative research the objective is to develop generalisations that contribute to already existing theory and thereby enhance knowledge about a phenomenon. With the

quantitative approach generally, deductive logic is used to test theories and hypotheses in a cause-and-effect order. Concepts, hypotheses and variables are chosen prior to the research and remain fixed throughout. In the case of qualitative research, inductive logic is typically used and hypotheses and concepts can emerge from the research, rather than being predetermined. Such subjective information provides a rich picture that helps to form theories to describe and explain the phenomenon rather than to contribute to existing theories about it.

Where methodology is concerned, the ontological issue is by far the most fundamental of the assumptions. This is because once a decision is taken about what constitutes reality, that belief will control the type of data collected, the data gathering method as well as the method of interpreting and presenting the research findings. Effective research design must therefore ensure that a consistent thread runs through all five philosophical assumptions.

3.3 Rationale for adopting qualitative paradigm

The main reason for basing this research on the qualitative paradigm was the nature of the problem. The research objective was to obtain a robust definition of the remanufacturing operation. However, researchers such as Meredith (1998) and Kirk and Millar (1991) propose that human activity systems (HAS) are too complex and subjective to be effectively studied entirely by objective means. Checkland (1981) defines a system as a set of elements connected together to form a whole entity, that exhibits the combined properties of the whole, rather than the properties of its individual component parts. He describes a HAS as a system that has human beings as some of its elements, for example a company or a sports team. Because a remanufacturing system falls within Checkland's definition of a HAS the research objectives must be achieved through qualitative research. A company is a special type of HAS known as a business process. Davenport and Short (1990) define a business

process as “a set of logically related tasks performed to achieve a desired business outcome”. Childe (1995) proposes that the business process “starts and finishes with the external or internal customers who are served by the process” and that “the process perspective encourages a holistic view of the activities that are needed to satisfy a customer requirement”. He states that a key advantage of the process perspective is that it recognises that improving one part of the process in isolation may not significantly improve the overall process because the processes are interdependent. Having selected the qualitative paradigm, the author chose to undertake the research using the case study approach. Yin (1989) defines a case study as an “empirical inquiry that investigates a contemporary phenomenon within its real life context, when the boundaries between phenomenon and context are not clearly evident, and in which multiple sources of evidence are used”.

3.4 Rationale for the case study approach

The case study method was selected because Creswell (1994), Meredith (1998), Chetty (1996) and Eisenhardt, (1998) propose that it is effective for qualitative research. Refer also to Yin (1984) who states that “case studies are needed where there is a need to understand complex social phenomena” and that “case studies allow an investigation to retain the holistic and meaningful characteristics of real-life events such as organisational and managerial processes”. Also, Romano (1989) and Lang and Heis (1994) propose that the case study approach offers many advantages for theory-building purposes, for example, the use of multiple data collection techniques and the constant testing of the emergent theory during its development. For this research the latter is particularly important because remanufacturing is a novel field for which there is a paucity of data and publications against which to assess the research findings. The constant testing of results permits in-depth and sustained assessment of findings and therefore increases the possibility of obtaining valid results.

Yin, (1989), Gummesson (1993), Romano (1989) and Chetty (1996) propose that multiple sourcing of information permits the phenomenon to be analysed from a variety of perspectives so that large quantities of information can be obtained and used to develop a rich picture of its nature. Because case study research can be an iterative method, the emergent theory is constantly tested and amended during its development so that a chain of evidence from different sources is obtained to support the research findings. Eisenhardt (1998) proposes that this characteristic is likely to make case study results more accurate than findings obtained from alternative approaches.

Yin (1984) describes three types of case studies, exploratory, descriptive and explanatory cases. He defines the exploratory case as one “where the goal is to develop pertinent hypotheses and propositions for further inquiry” and proposes that the descriptive case as one “where the objective is to describe the real-life context in which the investigation has been undertaken”. Also, he states that explanatory cases are concerned with “answering “how” and “why” questions” because “their goal is to identify causal relationships”.

Gummesson (1993) observes that case study types are not mutually exclusive and using the definitions of case study type provided by Yin (1984) this research can be described as being simultaneously exploratory, descriptive and explanatory. This is because the aims of this research include:

- Developing a definition that would be foundation for further remanufacturing research
- Describing remanufacturing so that others will understand it
- Explaining the causes of the remanufacturing problems so that methods could be developed to resolve them thereby enhancing the effectiveness and efficiency of remanufacturing operations.

The author undertook the case studies primarily using the descriptive data collecting tools of observation and qualitative interviews of key informants (Gummesson, 1993 and Eisenhardt, 1998). The advantages of these methods are that they permit non-verbal information such as artefacts and company data to be collected and that they support close interaction with the research domain. In such circumstances, the author was able to develop an individual understanding of the phenomenon.

Also, it was decided that a multiple case study approach (Romano, 1989; Yin, 1989 and Chetty, 1996) would be the most appropriate method for the task because Eisenhardt (1998) and Romano (1989) propose that they provide greater generalisability and have greater capability for creating theory than single cases. They state that this is because evidence from individual cases can be compared, firstly to draw out similarities that can help to develop a universal perspective of the phenomenon and, secondly, to test emergent theory and thereby avoid chance associations. Whilst there appears to be no consensus on the number of cases required to undertake a multiple case study, Chetty (1996) and Romano (1989) recommend a figure of between four and ten. They propose that this permits adequate data to be obtained to support the generalisation requirement of theory-building while simultaneously avoiding information overload.

Eisenhardt (1998) and Gummesson (1993) propose that additional cases are not required once theoretical saturation has been attained. In this research the point of theoretical saturation was established by systematically testing results at conferences and trade fairs and by reviewing results with case study companies until it was clear that significant new information had ceased to emerge from additional cases.

The research sought to take a holistic approach to describing the remanufacturing operation, by comprehensively describing the remanufacturing business process, so that the remanufacturing operation could be effectively understood and defined in the context of its total system. The reason for this is that the remanufacturing operation is a sub-process of the remanufacturing business process which is very complex. Researchers such as Gummertson (1993) have stated that the sub-processes of complex systems cannot be effectively understood as isolated entities because of their intricate inter-relationships. Also, researchers such as Guide and Srivastava (1997a) propose that recoverable manufacturing systems require system-oriented solutions rather than optimisation of systems' sub-processes. In this context recoverable manufacturing systems describe production techniques such as remanufacturing that process used products with the aim of recovering them or their components and/or materials (Mellissen and Schippers, 1999).

3.5 The legitimacy of the research

Gummertson (1993); Holloway (1997); Lang and Heis (1994) and Easterby-Smith *et al.* (1993) stress the importance of criteria such as validity, reliability and generalisability in establishing the validity of a piece of research. The importance of these criteria as key concepts in effective research design is a concern shared by case study researchers such as Yin (1981) and Eisenhardt (1998). Yin (1994) proposes that four logical tests, construct validity, internal validity, external validity and reliability are particularly applicable to case study analysis. Construct validity and reliability are concerned with data collection quality control and the methods used to improve these criteria in this research are described in sections 3.5.1 and 3.5.2. External validity measures the quality of research design and according to Yin (1984) is concerned with "establishing the domain to which a study's findings can be generalised". Replication logic was used to test the external validity of the research and this issue is discussed in section 3.5.3. He also proposes that internal validity is

suitable for explanatory cases only because it is concerned with establishing a causal relationship, whereby certain conditions are shown to lead to other conditions. In this case study pattern-matching was used to establish causal links. This involved the use of methods such as case-to-case comparisons and selection of categories to analyse the research information as described in section 3.7.5.

3.5.1 Construct validity

Triangulation (Romano, 1989; Gummerrsson, 1993 and Holloway, 1997), establishing a chain of evidence and key informants review of the case study reports (Yin, 1994) were used to test the quality of research information and thereby to strengthen the validity of the overall research.

However, there are some discrepancies about the exact definition of triangulation. Although it is agreed that triangulation requires the use of multiple sources of evidence, researchers such as Romano (1989) state that there is no consensus among researchers on the number of different methods required for effective triangulation. He further insists that triangulation requires a minimum of three different methods. This research uses the definition of triangulation proposed by Romano (1989) and the triangulation technique employed was between-method-triangulation. This involved collecting data from case study companies via semi-structured interviews, direct observation and participant observation. Also the author interviewed employees from three different levels of each case study company. The individuals interviewed were senior personnel (e.g. manufacturing directors), middle management (e.g. line managers) and operators.

To establish a chain of evidence, field diaries were kept so that information that could help to prove or disprove the emergent definition would be documented. For example, diagrams

of the remanufacturing operations for each company were drawn and documented with the relevant case study report so that the information obtained from individual companies could be more easily compared. In the case of key informants review of case study reports, the author ensured that the case study reports were examined by at least the principal interviewees in each company so that errors and misunderstandings could be identified and corrected. These procedures facilitated the documentation of anomalies so that they could be noted for further analysis while events that appeared to support the emerging definition were easily noticed, classified and, where possible, rechecked to ensure their reliability.

3.5.2 Reliability

Reliability is concerned with the ability to obtain similar outcomes on repeating the research. Because of this researchers such as Yin (1994) propose that reliability techniques should help to ensure that errors and biases are minimized in a study. The reliability techniques used in this research include asking informants the same question in a variety of ways to ensure that they understood the researcher's meaning and rephrasing the informants' answers before repeating them back to ascertain that their meaning had been understood. Also, investigations were undertaken in companies to ascertain that they practised their stated doctrine. Such investigations led to the removal of companies with less than fifteen employees from the study. The main reason for this was that it became apparent that very small companies undertook a variety of secondary market production processes but generally did not isolate their remanufacturing data so that it was difficult to establish their true remanufacturing practices and remanufacturing-related problems.

3.5.3 External validity

External validity is concerned with the extent to which the research findings can be applied to other instances of the phenomenon (Yin, 1994). This factor can be used to judge the

quality of research design because effective research design should dictate where the research findings should be applicable. Creswell (1994) states that case studies rely on analytical generalisation which he describes as the situation where the researcher is striving to generalise a particular set of results to some broader theory. He further proposes that generalisation is not automatic and that the theory developed must be tested through replication in at least one other instance where the theory has specified that the same result should occur. He also states that once replication has been made, the results might be accepted for a much larger number of similar neighbourhoods, even though further replications have not been performed. This research is investigating the electromechanical sector of the UK remanufacturing industry. The measures taken to ensure the external validity of the research findings include testing the new definition in new remanufacturing companies and also having the generic model assessed by non-case study companies and academics. The testing of the definition and that of the model are described in chapters 6 and 10 respectively.

3.6 The issues considered in the choice of research methodology

The author had already decided that the research should be undertaken by case study approach because of the reasons explained in 3.4. Hence, the requirement was now to select a research methodology that supported and complemented case study analysis and, in particular, theory inducting by case study analysis (Gummerrsson, 1993). At the same time, the methodology must be appropriate for use in the research domain and must be able to obtain results that satisfy the needs of remanufacturing practitioners.

Eisenhardt (1998) describes a method of structuring research that has been shown to be an effective model for building theory from case studies. The following sections illustrate the suitability of this structure by considering issues such as the researcher's involvement, the

domain of the research and the needs of the practitioner (Thomas and Tymon, 1982).

3.6.1 The researcher's involvement

The researcher was not employed by any of the case study companies during the research. However, the epistemology of the qualitative paradigm requires the researcher to interact with those being researched (please refer to 3.2.2). Eisenhardt's methodology (1998) supports such requirements because it demands close association with the research domain and this would facilitate interacting with remanufacturing employees.

3.6.2 The domain of the research

Voss (1984) has stated that Production and Operations Management (POM) is concerned with the integration of procedures, processes, operating decisions, company policies and technologies to maximise the competitiveness of the company. The objective of this research is to determine a robust and valid definition of remanufacturing and thereby help to enhance remanufacturing knowledge so that effective and efficient remanufacturing operations can be more easily designed and implemented. For this reason, the researcher believes that the work lies in the domain of POM research. The research methodology selected for the work must therefore be suitable for POM research. Eisenhardt's case study framework (1998) is suitable for this research because it has been specially developed for organisational research and POM research is a subgroup of such research.

3.6.3 The needs of the practitioner

Thomas and Tymon (1982) define the practitioner as "Any line manager, staff specialist, consultant or any organisational actor". They propose that, for any new knowledge to satisfy the needs of the practitioner, it must fulfil the following five needs:

1. *Descriptive Relevance*. This can be described as the accuracy with which the research has captured the problem or phenomena that the practitioner encounters. Descriptive relevance is concerned with the generalisability of the research findings. It can also be described as external validity (see for example Lang and Heis, 1994; Campbell and Stanley, 1965 and Holloway, 1997).
2. *Goal Relevance* refers to the ability of the new knowledge to deliver results that are relevant to the practitioner. For example, the new knowledge should be capable of helping the practitioner influence the problem in his or her organisation.
3. *Non-obviousness* describes the originality of the new knowledge in the sense that the new knowledge must be greater than the common sense observations and practices already available to the practitioner.
4. *Operational Validity* is concerned with the ease and convenience with which the practitioner can access and apply the new knowledge.
5. *Timeliness* is a measure of the punctuality of the new knowledge because to be truly useful the new knowledge must be available to the practitioner at the time that he requires it.

Taking into account the needs of the practitioner detailed above it is evident that the new knowledge derived from the research must:

- Be correct and generic to practitioners from the electromechanical sector of the UK remanufacturing industry irrespective of their specific organisational characteristics, for example, size and product type (*Descriptive relevance*).
- Be easy to understand and manipulate so that practitioners can use it (*Operational validity*).
- Be able to help remanufacturers and others to gain an in-depth understanding of the remanufacturing operation so that its effectiveness and efficiency could be more easily improved if required (*Goal relevance*).
- Exceed the common sense resource currently available to remanufacturers (*Non-obviousness*).
- Be available at the time that remanufacturers require it in order to help resolve their problems such as the shortcomings of current remanufacturing definitions as well as paucity of remanufacturing knowledge and research (*Timeliness*).

Platts (1993), Chase (1980), Susman and Evered (1978), Buffa (1980), Hill (1987) and Meredith *et al.* (1989) contend that too much emphasis has been placed on research methods and techniques while the needs of the company have been insufficiently considered. Because of this the methodology chosen must be capable of structuring the research so that its findings would be beneficial to remanufacturing practitioners. Eisenhardt's theory-building approach (Eisenhardt, 1998) is a user-based research mechanism. As such it is ideally placed to satisfy the practitioners' needs because its empirical evidence and therefore its findings are grounded in the practitioners' reality. For example, it permits the research focus to be amended in consideration of the practitioners' most pressing needs. Eisenhardt (1998) states that this non-prescriptive feature is one of its major strengths because it makes it extremely flexible. The following paragraphs describe Eisenhardt's (1998) framework and explain how it was used to structure the research.

3.7 Eisenhardt's (1998) case study theory building framework

The eight stages of this framework are getting started, selecting cases, crafting instruments and protocol, entering the field, analysing data, shaping hypothesis, unfolding literature and reaching closure. Although these stages are clearly defined, the boundaries between them often merge. In fact, the data collection, data analysis and theory-building processes occur simultaneously in an iterative fashion. However, this is one of the framework's major advantages because many established researchers such as Glaser and Strauss (in Eisenhardt, 1998) believe that data collection and analysis should be joint processes in research.

3.7.1 Getting started

Literature search was used to determine the scope of remanufacturing knowledge. This involved obtaining a working definition of remanufacturing as well some initial hypothesis about its nature and its key problems. The definition helped to focus the work by specifying the type of companies that were probable remanufacturers so that the research effort could be geared toward them.

3.7.2 Selecting cases

The next activity was to use the working definition to identify practitioners who could help further the research by supplying information for developing the new definition or by being used to validate the research findings. This was achieved using a theoretical sampling plan where practitioners were selected on the basis that they were members of the electromechanical sector of the UK remanufacturing industry. This was necessary, for the reasons of validity that were previously discussed, to limit excessive variation so that effort is restricted to potentially useful cases and to increase the possibility of obtaining results that truly addressed the needs of remanufacturing practitioners.

3.7.3 Crafting instruments and protocol

This activity involved using the validity and reliability techniques that were discussed in Section 3.5. to strengthen the grounding of theory. The main theme here was to ensure that the true meanings of informants' statements were understood and also to reduce the opportunity for unintentional tainting of research information because of the author's bias and other research anomalies.

3.7.4 Entering the field

This activity sought to speed up analysis and reveal helpful adjustments to data collection. It also permitted the author to promptly use the information from the empirical evidence to augment the emergent theories and definition, to improve the definition and theory development processes and to enhance the usefulness of the research to practitioners. The author achieved this objective using detailed field notes.

3.7.5 Analysing data

Here, the case study information was analysed to develop initial definitions from the empirical evidence. Analysis was achieved using within-case analysis and cross-case pattern searching because Eisenhardt (1989) proposes that such techniques facilitate thorough evaluation of research evidence. A common advantage of the data analysis techniques used in this research was that they provided a mechanism for coping with the vast amount of information because they permitted their analysis to be performed in manageable "chunks".

In the case of within-case analysis detailed write-up and analysis was undertaken for each case study so that the author understood each one as a stand-alone event. Also, within-case analysis facilitated cross-case pattern searching because information from current cases could be documented and compared to those obtained from new and preceding ones.

Cross-case pattern searching involved considering the research information in divergent ways. An advantage of this technique is that it helps to reveal research disturbances such as subjective bias thereby enhancing the validity and reliability of the information gathering and analysis. Cross-case pattern searching was achieved using case-to-case comparison and selection of categories. In the case of case-to-case comparison, cases were paired and differences and similarities between the cases were identified, studied and noted for further analysis. This overlapping of the data analysis and data collection processes helped to promote understanding so that, for example inappropriate cases could be quickly identified and removed from the research. Details on the removal of inappropriate companies are given in Section 3.5.2.

For the selection of categories, cases were paired on the basis that they belonged to one of five groups, OEM, contract, independent, small and large remanufacturers (Lund, 1984) and were analysed for differences and similarities. The differences and similarities were then compared to those exhibited by different groups so that common similarities between all five groups could be pulled out and used as a basis for developing a generic remanufacturing model. This facilitated the development of hypotheses about causal links, for example identification of the causes of complexity and problems in remanufacturing operations in general. It also helped to develop hypotheses about the relationship between the type (or group) of remanufacturer and the remanufacturing practice adopted. Chapter 5 presents two standard remanufacturing operational flow charts and explains that the operation followed by a remanufacturing company depends typically on the group to which it belongs.

3.7.6 Shaping hypotheses

Eisenhardt (1989) proposes that the objective of shaping hypotheses is to enhance the validity of the emerging hypothesis and this can be achieved in two ways. The first method,

“sharpening construct” is concerned with establishing construct validity, the second, is concerned with internal validity. The author enhanced the validity of the emergent theory by improving the quality of the data gathering process using construct validity enhancing methods such as triangulation that were discussed in section 3.5.1. The internal validity of the research findings was enhanced using for example, “case-to-case comparison” and “selection of categories” and these are described in section 3.7.5.

3.7.7 Enfolding literature

This activity sought to increase confidence in the research findings by linking the emergent theory with extant literature. Here, literature asserting that remanufacturing was dissimilar to repair and reconditioning was cited to illustrate that a genuine phenomenon was being investigated. At the same time, literature that contradicted the definition of remanufacturing obtained by the research was examined to demonstrate the insufficiencies of current definitions of remanufacturing and thereby to explain the contribution of the research to knowledge. Also, literature on modelling techniques was analysed to substantiate that an IDEF0 generic model of the remanufacturing business process could effectively describe the research findings.

3.7.8 Reaching closure

In this research the decision on when to close the research was taken according to two criteria, the possibility of obtaining increased understanding from additional cases and, that of theory improvement through further iteration between theory and research information as explained in Section 3.4.

3.8 The overall structure of the case study research

The nine activities of the case study research are illustrated on figure 3.1 and described in the following paragraphs.

3.8.1 Literature survey

At the beginning of the research, a literature survey was undertaken to investigate the extent of remanufacturing knowledge and research. This is described in chapter 2. The remanufacturing issues identified include the paucity of remanufacturing research and publications, the scarcity of analytic models of remanufacturing and the ambiguity of current remanufacturing definitions. It was also identified that models are proven methods for describing complex systems such as remanufacturing and that the IDEF0 modelling technique is effective for assisting the description and understanding of business processes. In the absence of a universally accepted definition of remanufacturing, the author adopted the definition proposed by Haynsworth and Lyons (1987). This working definition would be used to identify remanufacturers but may be amended as the research uncovered additional information.

3.8.2 Obtaining case study companies

It was extremely difficult to identify remanufacturers using common sources such as the Yellow Pages and Trade Directories because generally, the term “remanufacturing” is not used in the UK. The author therefore obtained case study companies using an approach consisting of a two-stage survey and telephone interview. In the first stage of the survey, the author faxed the project description to in excess of 150 secondary market (used products) companies from the Midlands to the Southwest of England and asked them whether they understood the meaning of the term “remanufacturing”. They were also asked to identify any remanufacturing companies known to them. This approach revealed 50

potential remanufacturers. The second stage of the survey narrowed the search down to companies that were most likely to be “genuine” remanufacturers. This involved asking the 50 companies whether their remanufacturing practices conformed to Haynesworth and Lyons (1987) definition of remanufacturing.

Using this approach, 25 companies were selected on the basis that the surveys indicated that there was a high probability that they adhered to the adopted definition. The next step was to use telephone interviews to identify the “genuine” remanufacturers among them. This involved discussing the remanufacturing operation with the 25 companies by telephone to gain further information about their remanufacturing practices and also to obtain willing collaborators for the research. Thirteen case study companies were identified from the telephone interviews, together with a list of proposed remanufacturing problems and an initial flow chart of the remanufacturing operation. The next step was to select a research method that would obtain in-depth, accurate information.

3.8.3 Research design

In this instance case study analysis (Chetty, 1996; Romano, 1989) was selected. The rationale for adopting the qualitative paradigm and using case study approach is presented in section 3.4.

A 3-phase research methodology was adopted. This involved dividing the thirteen case study companies into three groups, one group for Phase 1 case studies, a second group for the Phase 2 and the final group for the Phase 3.

Figure 3.1 The overall structure of the research



The Phase 1 case studies are described in chapters 4 and 5 and were one-day observational studies that analysed the remanufacturing operation so that a robust definition could be obtained for it. The Phase 2 case study companies were the in-depth cases that validated the new definition and are presented in chapter 6. The Phase 3 case study is described in chapter 9 and sought to understand the remanufacturing business process so that the remanufacturing operation could be defined in the context of its total system. The reason here was to provide a vehicle for accurately describing the research findings so that others could use it because they would explicitly understand the meaning of remanufacturing.

3.8.4 Developing a robust new definition of remanufacturing

Because of the geographical distances involved it was decided to limit the number of visits to individual companies. As a result detailed information was collected from the companies during case study visits lasting one full working day. Necessary, additional information was obtained by telephone and fax. During the Phase 1 case studies it became apparent that 5 of the companies undertook a variety of secondary market production processes but did not isolate their remanufacturing information. The companies were removed from the study on the basis that their remanufacturing practices were unclear. This stage also involved testing the results by discussing them with non-case study practitioners at conferences and trade fairs. The research question during the phase 1 case studies was “what is remanufacturing”. Their major outputs were:

1. An adapted definition of remanufacturing.
2. A flow chart of the remanufacturing operation.
3. Identification of some key production control issues of the remanufacturing operation as well as their causes.

3.8.5 Validating the new definition

The Phase 2 case studies were undertaken to confirm the new definition because researchers such as Eisenhardt (1998) propose that one of the main strengths of case studies is their capability to develop theories and hypotheses that are likely to be testable. Also, Yin (1994) and Gummerrsson (1993) maintain that a piece of research is proved genuine if it can be shown that the research results can be extended to other occurrences of that phenomenon. The research question here was “ Is the new remanufacturing definition correct?”. The main output was validated Phase 1 case study results.

3.8.6 Analysing the new definition

Here the new definition was analysed by comparing actual remanufacturing, repair and reconditioning practices. The research question here was “ What are the deficiencies of current remanufacturing definitions and how does the new definition overcome them?” The output of this activity was clear illustration of the shortcomings of the working definition and explanation of how the new definition augments the working definition. This analysis is presented in chapter 7.

3.8.7 Examining the IDEF0 modelling technique

Here the author used the literature and personal experience to assess the process modelling capabilities of the IDEF0 technique. The research question here was “ Does the IDEF0 technique have proven qualities for such business undertaking?” The output here was identification of the successful use of the IDEF0 modelling technique for related business undertakings as well as documentation of its advantages over some better-known modelling methods.

3.8.8 Making the research findings useful to others

For this activity the Phase 3 case study examined the remanufacturing business process so that the remanufacturing operation could be described in the context of its total system. The rationale for this was that researchers, for example, Checkland (1981) and Meredith (1998) propose that it is impossible to effectively study one component of a complex system in isolation. The research question here was “What constitutes the remanufacturing business process and what is the relationship between the remanufacturing operation and the other sub-processes of the remanufacturing business process?” The output here was a comprehensive IDEF0 generic model of the remanufacturing business process. This model development stage of the research and the Phase 3 case study is described in chapter 9.

3.8.9 Validating the model

This final stage of the research sought to test the model’s validity. To satisfy the requirement of replication logic a panel consisting of roughly equal numbers of case study companies and non-case study companies from the electromechanical sector of the UK remanufacturing industry, as well as remanufacturing academics, was asked to test the research findings. The testing method was the qualitative technique of validation by review (Landry *et al.* (1983)) and the validation criteria were the model’s sufficiency, accuracy, clarity and usefulness as a representation of the remanufacturing business process. The purpose here was to show that, if the research findings were applicable to both case study and non-case study practitioners, then there was a good chance that it may also apply to other remanufacturers. Here, the research question was “Is the model generic, useful and a valid representation of the remanufacturing business process?” This validation process is explained in chapter 10. Its outputs were a validated generic model of the remanufacturing business process and a list of proposed uses for the model.

3.9 Summary

This chapter has discussed the research design. It has attempted to justify the choice of the qualitative paradigm as a basis for the research design. It has also explained the choice of the use of the multiple case study approach. Finally, it has summarised the research methodology.

The following chapter describes the Phase 1 case studies.

Chapter 4: The Phase 1 case studies

4.1: Introduction

The previous chapter explained the research design. This chapter describes the Phase 1 case studies that sought to define remanufacturing. Five companies, A, B, C, D and E were involved in these one-day observational studies of the remanufacturing operation. The first part of this chapter describes the overall procedure used to undertake the studies while the second presents the individual cases.

4.2 The Phase 1 case study procedure

The Phase 1 case studies had the four stages illustrated in Figure 4.1

Figure 4.1: The Phase 1 case study procedure

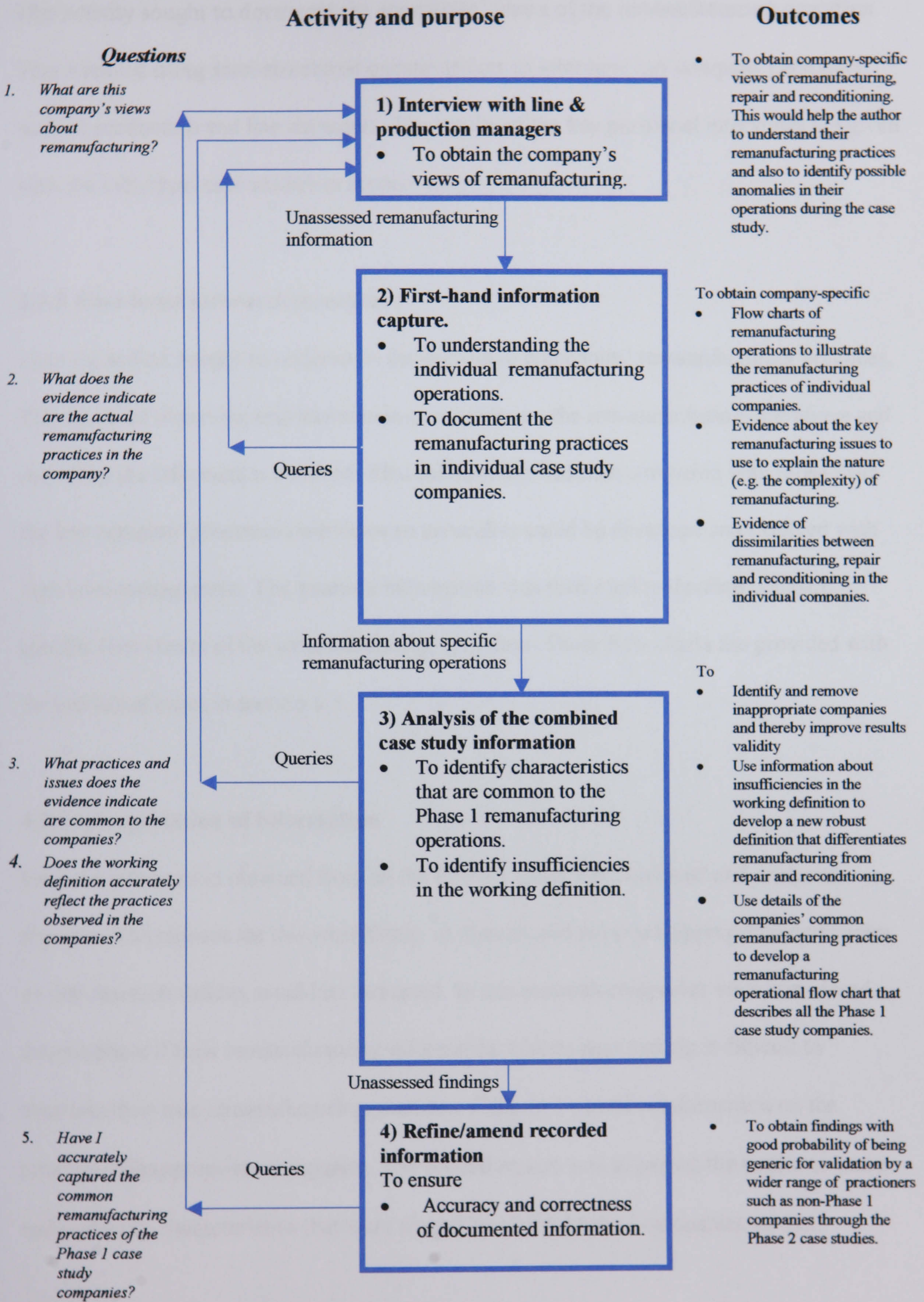

4.2.1 Key personnel interview.

This activity sought to document the companies' views of the remanufacturing operation.

This involved using semi-structured questionnaires to interview key company personnel such as production and line managers. The results of the key personnel interviews are given with the individual case studies in section 4.3.

4.2.2 First-hand information-capture

Here the author sought to understand the individual companies' remanufacturing practices.

This involved observing and interviewing operators on the remanufacturing operations and recording the information obtained. That information was then compared with those from the key company personnel interviews so anomalies could be discussed and resolved with high level management. The assessed information was then used to develop company-specific flow charts of the remanufacturing operation. These flow charts are provided with the individual cases in section 4.3.

4.2.3 Interpretation of information

Here the information obtained from all the Phase 1 cases was combined and analysed together. The reasons for this were firstly, to identify and remove inappropriate companies so that research validity would be increased. In this research companies were considered inappropriate if their remanufacturing information was unclear making it difficult to ascertain their true remanufacturing practices. Chapter 3 provides information on the removal of inappropriate companies. The second reason was to permit the author to more easily identify characteristics that were shared by all the Phase 1 companies so that:

- a) A remanufacturing operational flow chart that described the common remanufacturing practices of the companies could be drawn.

- b) Shortcomings in the working definition could be noted and used to help develop a new robust definition of remanufacturing. Here, the working definition was assessed in terms of its ability to differentiate remanufacturing from repair and reconditioning.

The plan was now to ensure that the author's conclusions about the remanufacturing operation reflected the practices of the Phase 1 companies and this was achieved by having the Phase 1 companies assess the author's understanding of remanufacturing. This involved having the companies examine the recorded remanufacturing information in the fashion described in section 4.2.4 below.

4.2.4 Refine/amend recorded information

The case study results were presented for assessment to the general and line managers of the companies so that any misunderstanding could be debated and final amendments made to the conclusions. At the same time, telephone discussions were used to discuss the information between all the Phase 1 case study companies. These procedures ensured that the recorded remanufacturing practices were common to all the Phase 1 companies.

The outputs of the refine/amend recorded information activity were:

1. Phase 1 case study companies' approved new definition of remanufacturing.
2. Phase 1 case study companies' approved information about the remanufacturing operation.
3. Phase 1 case study companies' approved generic remanufacturing operational flow chart.

These final conclusions of the Phase 1 case studies are presented in chapter 5. The following section describes the individual Phase 1 case studies.

4.3 The Phase 1 remanufacturing operations.

4.3.1 Company A

Company background

Company A rebuilds rolling stock. Its capabilities range from remanufacturing (rebuilding to at least original specification from the customer's perspective) to reconditioning and repairing (rebuilding back to a range of satisfactory working condition that may be below the original specification). The rebuilding option selected depends on the customer's requirements and financial circumstances. This company has three UK sites and has a worldwide market. Because of its contractual relationship with its major customers company A can often predict the type and quantity of work that it will obtain and often even when these will arrive. It has approximately 350 employees and a turnover of £17 million per year.

Company A's train remanufacturing operation

Company A's remanufacturing operation occurs through the eleven activities shown in figure 4.2. With the exception of exterior painting, blasting and train test each of the activities has a specified place on the factory floor. Also, the exterior painting and blasting activities are subcontracted. The activities of company A's remanufacturing operation are described in the following paragraphs.

Pretest/Sluice.

The rebuilding program begins with the cleaning (sluicing) of the train to facilitate accurate assessment of rectification needs. This is followed by an initial fault analysis that is carried out in the presence of the customer or his representative. Faults are divided into two

groups, core work (tasks that the company is obliged to perform as part of its remanufacturing program) and non-core work (rebuilding tasks that the company has no obligation to undertake). Examples of non-core work include modifications that are not in the original specification but that occur as standard in more recent models. Following pre-test the customer is given a list of the non-core work along with their estimated rectification costs but those tasks are undertaken only at the customer's request and provided that job costs have been agreed. Pretest/sluice also involves the decoupling (separating) of the train into its individual vehicles so that they can be worked on individually.

Strip

Strip describes the dismantling of the vehicles. Here the interior of each vehicle is completely gutted. Worn components are sorted into groups depending on whether they are discarded as standard (replaced whatever their condition) or can be reclaimed (rebuilt to the required standards and reused). Examples of components that are discarded as standard include curtains, pelmets and toilet linoleum. Typically, such components are listed on a mandatory replacement document because they undergo extensive wear and are also inexpensively replaced. More expensive but easily rebuilt components such as luggage racks are sent to the appropriate section for internal rebuilding. Sub-assemblies requiring extensive rebuilding programs such as seats and roof racks are rebuilt by external subcontractors and are removed during the strip activity and placed in containers at their holding area until they are collected by or sent to the external subcontractor.

Blast

The blast activity describes the shot blasting of the vehicle to remove contamination such as rust and old paint and create a good repainting surface. This activity is carried out at night by internal subcontractors (other members of the company).

Figure 4.2: Company A's train remanufacturing operation

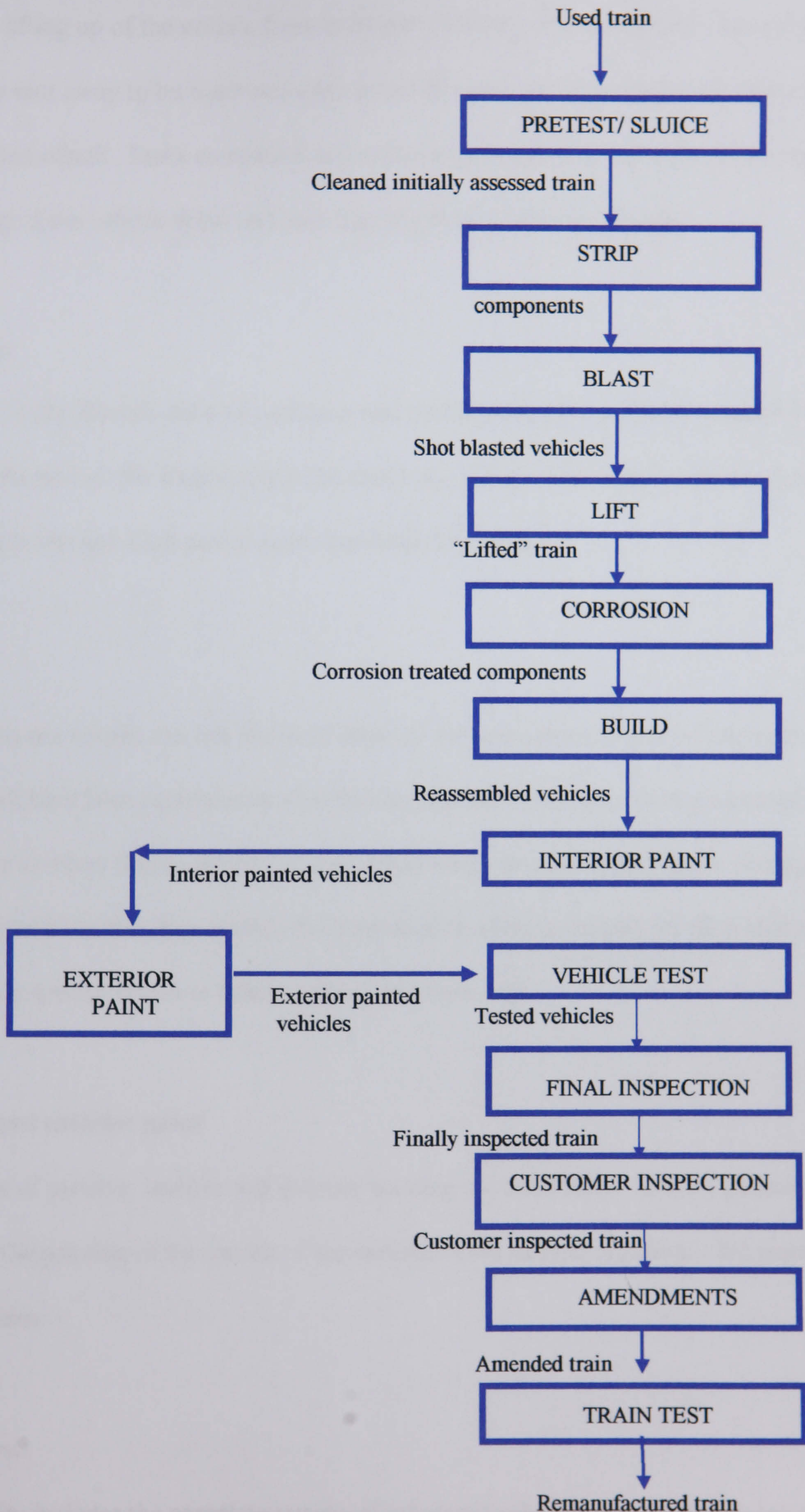

Lift

Lift is the lifting up of the vehicle from its bogies (wheels). Following their removal the bogies are sent away to be examined and remanufactured while the underside of the train is analysed and rebuilt. Tasks completed during lift include the removal of the brake modules, vacuuming of the vehicle skirts and painting the underside of the vehicles.

Corrosion

Corrosion is the identification of corrosion and rectification of corroded subassemblies. Tasks performed at this stage include the removing of doors and windows for analysis, rebuilding to the specified performance standards and cleaning.

Build

By the time the vehicle reaches the build stage all the components removed during the strip activity will have been reclaimed or else their replacements will have been purchased. The build stage involves the reassembly of the vehicle using new and rebuilt parts. Examples of tasks performed at this stage include the introduction of replacements for discarded as standard components such as toilet linoleum and table tops.

Interior and exterior paint

Two types of painting, interior and exterior painting are undertaken. Interior painting describes the painting of the insides of the vehicles while exterior painting is the painting of their outsides.

Vehicle test

This activity includes the complete testing of individual vehicles. Any final cleaning or amendment will also be undertaken at this point. Tests undertaken at this stage include the

examination of the communication system. Operators carry out detailed examination of the vehicle and note any omissions on snag sheets. Snag sheets are key accompaniments to the work record documents and list unsatisfactory work prior to the final assessment of the rebuilt vehicle. Once operators have completed rework of the tasks recorded in the snag sheets to their satisfaction they will turn the vehicle over to management for final assessment.

Final inspection, customer inspection and amendments

A final inspection of the vehicle is carried out by management. If the vehicle is satisfactory the customer is called to make his own assessment. Any work that the customer finds unacceptable will be analysed and corrected.

Train test

This is a whole system test and occurs when both the customer and the company are satisfied with the vehicles. It involves the recoupling of the vehicles and the testing of the whole train. If this final test is successful then the rebuilt train is dispatched with the relevant warranty.

Control

Inventory management

To limit inventory, time wastage and overheads, Company A's train rebuilding process does not support a stock room. A type of two-bin system is used to manage the inventory required for the train rebuilding process. All bins are open to enhance visibility and are placed at their point of use however the method used to control the two-bin system depends

on the cost of the component. For example the bins used for expensive components are colour-coded but those for inexpensive components are not.

Inexpensive components

In the case of inexpensive components, for example, nuts and bolts the component bins are regulated by local suppliers who visit the company twice a day. Typically, these visits occur once in the morning to note which components must be replenished, and again in the afternoon to deliver the required components.

Expensive components

Expensive components are divided into two groups, 100% items which have predictable usage and those where usage cannot be anticipated. 100% items are controlled by scheduled call off system while small quantities of unpredictable items are held in bins at their point of use “just-in-case”.

For expensive components the bins contain the minimum required component quantities.

Each expensive component has two bins, a major bin and a minor bin and the major bin is placed immediately behind the minor bin. Also, all major bins for expensive components are green irrespective of the sub-process they belong to but minor bins have a colour that is specific to the activity in which they are used. This is to help suppliers and the workforce to identify the different components.

Operators take components as required from the front (minor) container but only material controllers and suppliers may remove or put components in the back (major) containers.

Each sub-process has a material controller who issues components from the back container to the front container and also ensures that suppliers replenish the back containers at appropriate intervals.

The material controller

The material controller is assisted in his task by the material action board. This board is available beside all activity stations and details the description, catalogue number, shortage quantity and required date of components. Operators complete the board when shortages occur and material controllers must state when the required components will be available. Management check the board regularly to identify the reasons for any shortages that have occurred. Also, if the material controller is unable to provide required components by the date that he has promised, management must investigate the reasons for the failure. Company A has a policy of rating suppliers and these boards play a part in the company's vendor assessment program.

Production scheduling

Output is managed via production schedules that are placed at the activities' notice boards. The notice boards also contain each activity's team member's photograph and details such as their respective skills, training and trade. Operators have autonomy over their tasks and must self inspect their work and to be vigilant for errors from the other activities. Additionally, each notice board has a tasks booklet that lists all the tasks and assessments that must be completed by that activity. Operators and the team controller must sign off tasks as they are performed. Apart from helping to ensure that no tasks are omitted, the booklets ensure that completed jobs are assessed at least twice. They also assist new recruits to carry out their duties with minimum supervision.

Two meetings, one quality and one risk analysis are held every fortnight and their purpose is to help the company to enhance product quality and to assess training needs.

Incentive schemes

A three-action group bonus scheme is used to enhance productivity and increase lead time. The company operates a two-shift system that must complete a train rebuild every twenty days. Operators are given a bonus for every train completed on time, an additional bonus is available for completing ahead of schedule and a third bonus can be obtained for every extra train completed above the required level within a two week period. The bonus system was designed to help boost shop floor moral and to ensure camaraderie. For example operators will automatically assist slower work mates, if only to ensure the group bonus.

Major problems

Company A believes that uncertainty is a greater problem for remanufacturing businesses in comparison to conventional manufacturers. The main reasons given were, the unknown quality of incoming work, lack of knowledge regarding the availability of required components and ignorance and confusion about the suitability of components given changes in legislation. Other problems include difficulties in reducing the supplier base. The reason in this case is that producers of components for some old train designs are scarce. Company A is therefore tied to these suppliers no matter how inconvenient the situation may be.

Major needs

Company A believes that one of its greatest needs is to have a flexible workforce. This is because the company believes that profitability and productivity can be better enhanced by “working smarter rather than sweating harder”.

4.3.2: Company B

Company B was formed in 1992 and rebuilds quarrying equipment. It has only one UK plant but its products are exported to many parts of the world. This company can provide a

wide variety of engineering services to suit the needs of most companies. This includes individual assignments, production runs of mechanical components and fabrications. The company also provides a parts repair and remanufacturing service. In this company remanufacturing involves bringing the used product at least to original specification and is more expensive than repair and reconditioning because remanufacturing involves the use of comparatively greater resource than the other two processes. Company B has no competitor for its complete package, defined as the range of services that it offers but has competitors for the individual branches of its business. Its turnover is £1.5 M per annum and it has 20 permanent staff. The company's representatives during the case study were some supervisors as well as the general manager who also owns the company.

The information given under critical issues, key problems and overall management view in the paragraphs following are direct reports of Company B's representatives and do not represent the author's views of that company or remanufacturing companies in general.

Critical issues

According to Company B the order qualifier for remanufacturers is quality because customers do not want to buy substandard products but the order winner is cost. The company believes that critical issue is how to reduce operating costs whilst simultaneously increasing product quality. The company tries to minimise the lead-time between order receipt and job completion because short remanufacturing lead-time generally reduces production costs and also frees up company resources. The company stated that the most important task of remanufacturers is obtaining the correct blend of technical skill, product knowledge and product history. It also believes that there is a great need for flexibility in remanufacturing businesses because this can help to increase worker productivity.

Key problems

The company stated that uncertainty makes planning difficult. For example, it cannot precisely forecast the number of assignments that will be received in any given period and therefore must often subcontract to stay abreast of its schedules and satisfy customers.

Although the company has a list of good quality free-lance workers it believes that subcontracting in and out can have adverse results. It stated that this is because in such circumstances operational control is far more difficult and requires significantly greater effort. The company stated that the time between giving a quote and receiving the order varies considerably, and can be anything from a day to a year. It stated that at times this has exceeded a year or the customer has declined but has not informed the company. Company B stated that its inventory costs are extremely high because it has to stock high quantities of remanufactured and newly manufactured components “just in case”.

Overall management view

To successfully compete for assignments a remanufacturer must have the technical skills required to produce high quality products. However, to win orders the remanufacturer must offer both lower product price and shorter lead-time in comparison to competitors. Balancing these two requirements often appears impossible. This is because in order to produce high quality products extensive testing of components and the finished product is required but at the same time high inspection levels extend remanufacturing lead-times. Also, expensive testing equipment such as ultrasonic machines may be required. There are no tools that can determine how much to test, when to test and often what constitutes a “good enough” component. It is all down to the expertise of the operator. The lack of remanufacturing guidelines and tools added to the complexity of component testing results in losses.

Typical examples of the type of loss that the company has sustained as a result of inadequate component assessment include:

Jaw crusher re-build

The product was remanufactured, assembled, tested and sent to the customer. After only three months in service the main shaft broke and the product was returned under warranty. When the product was stripped, it was discovered that the shaft had been cracked for some time. The shaft had been crack tested at the initial investigation but the crack had been missed. A new shaft was fitted and the product was assembled, tested and returned to the customer. The cost of poor investigation in this case was £12,000 in addition to the cost of lost production.

Cone cruncher

A 13 ton (small) cone cruncher failed at test. The cost to the company of stripping the product and re-testing was £315 (3 men working for 2 full days). In addition, a faulty gear was found and replaced at a cost of £2424. The total cost to the company of reworking this small cone cruncher was £2667. The margin on this job was significantly reduced.

Dumper transmission

The product was assembled and when on test it was found that the 5th gear would not engage. The fault had to be found and rectified. This involved stripping the gearbox completely because the 5th gear was packed first into the casing and hence had to be last out. The fault was found to be a crack in the aluminium housing which should have been identified at the component investigation stage. The cost to strip the product, repair the fault and reassemble the product was £880.

The author's observations about Company B

The company reiterated the views of other remanufacturers for example, the need for flexibility, the issues of uncertainty and how to balance the contradictory needs for low cost, short remanufacturing lead-time and high quality. In addition the company data illustrates the extent of adverse repercussions that remanufacturers encounter because of the difficulty of component assessment.

Figure 4.3: Company B's remanufacturing operation

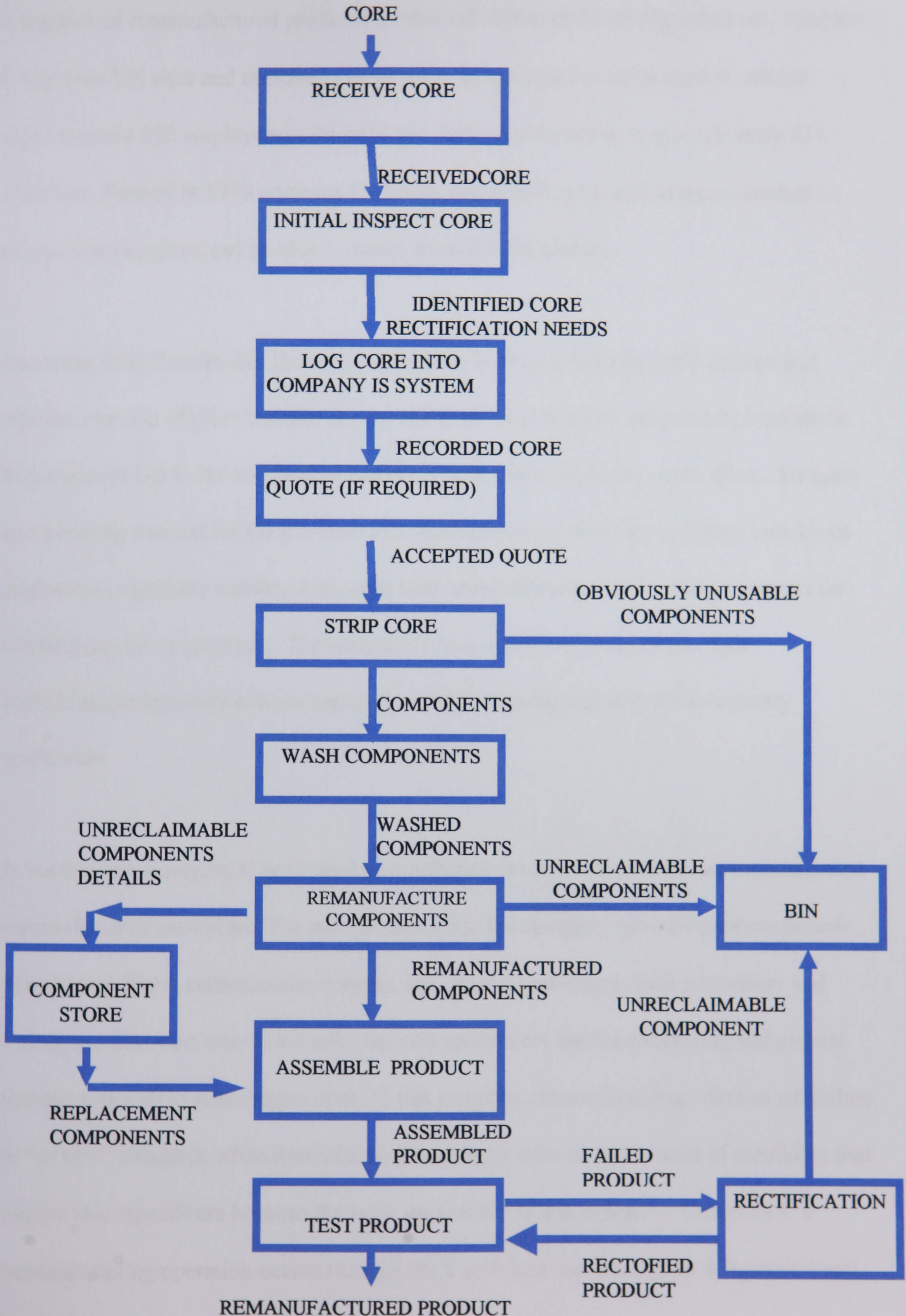

4.3.3: Company C

A supplier of remanufactured products for the soft drinks and brewing industries, company C has three UK sites and customers worldwide. It operates in a niche market and has approximately 220 employees at its main site. Its annual turnover is approximately £14 - 15million. Formed in 1979 company C initially began by buying and selling redundant or surplus brewing plant and products, mainly from British sources.

Operating from Portakabins the company quickly built up a reputation for prompt and efficient removal of plant and also for the ability to meet brewers' plant needs from stock. Rapid growth led to the company acquiring purpose built workshops and offices. To meet an increasing demand for the overhaul and modification of tanks, the company built up its engineering capability enabling it to undertake multi-million pound "turnkey" projects for brewing and beverage plants. The company's core activity is the supply of fully remanufactured process and packaging lines in the brewing and soft drinks industry worldwide.

In recent years company C has begun to supply new products to supplement the traditional remanufactured used plant. The new products that the company can now produce include silverstream fillers, carbonisation systems, high level depalletisers, flash pasteuriser and conveyors. The main interviewees for the case study were the manufacturing and general managers as well as some supervisors. In this company remanufacturing refers to rebuilding to "as new" standards while reconditioning and repair refer to lesser scale of rebuilding that require less expenditure because the work undertaken is less extensive. Company C's remanufacturing operation occurs through the 8 activities that are shown in figure 4.4 and described below.

Figure 4.4: Company C's remanufacturing operation

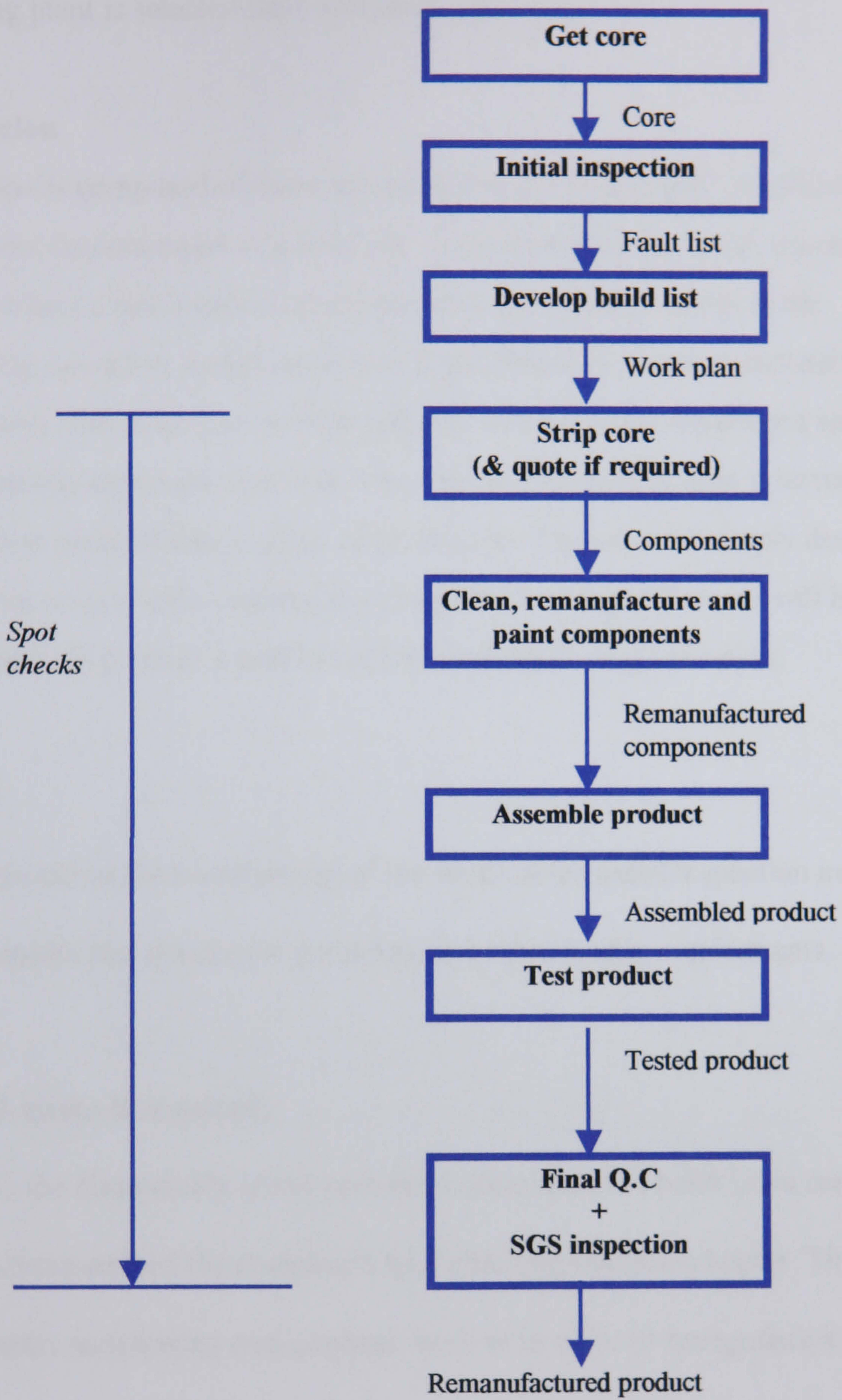

Get core

A used bottling plant is selected from company C's stock of cores.

Initial inspection

Initial inspection is composed of three sub-activities, visual appraisal, identification of specification and determination of a parts list. The purpose of the visual appraisal is to identify the product's faults and is considered the most critical activity in the remanufacturing operation. Initial inspection is performed by senior personnel because the company believes that shop floor workers do not have adequate experience and breadth of vision to effectively undertake that task. The objective of specification is to transfer detailed information from point of sale to point of production. The parts list simply describes and quantifies of the components required to remanufacture the product and will be updated weekly to reflect the product's position in the remanufacturing operation.

Develop List

This activity describes the transforming of the result of the initial inspection into a series of detailed documents that divides the parts lists into subassembly requirements.

Strip core (& quote if required)

This activity is the disassembly of the core and occurs once the build list is created. As soon as the core is disassembled the company's spot checking operation begins. This company only quotes when undertaking non-contract work or in order to renegotiate a contract.

Clean, remanufacture and paint components

Following disassembly all components are cleaned, brought to at least the original specification from the customer's perspective and painted. Components that cannot be brought back to original specification from the customer's perspective are replaced with new alternatives.

Assemble product

Product assembly describes the re-assembly of the product using an assortment of new and remanufactured components. This activity occurs when all components are available and at the correct specification.

Test product

This describes the testing of the product to the required specification.

Final control test and SGS inspection

This is the final activity of the remanufacturing operation. It is a visual assessment of the product and may include an SGS inspection at the customer's request. SGS inspections are tests administered by a certified independent assessor on the customer's behalf.

The information given under critical issues, key problems and overall management view in the paragraphs following are direct reports of Company C's representatives and do not represent the author's views of that company or remanufacturing companies in general.

Critical issues

The critical issue for remanufacturers is cost control and this is an important purpose of decision making. For example, what effective strategies can a remanufacturer adopt in order to reduce production cost given that the remanufacturer relies on his reputation for quality, reliability and speed of delivery in order to survive?

Key problems

Company C believes that in comparison to independent and new remanufacturing companies, uncertainty is not a major hurdle for well established remanufacturers. The

Company stated that this is because typically, well established remanufacturers have a wealth of historical data and experience and generally, these advantages provide them with scope to deal with anything that the market can throw at them. Additionally, many such companies have contracts either formally or informally (i.e. there is nothing written on paper but X will always come to us), as a result many orders are repeats or at least similar enough not to raise too many eyebrows.

The key remanufacturing problem area was the decision making process especially regarding cost reduction. For example, the range of prices at which a remanufacturer can sell his product is predetermined by the market since customers will not usually purchase a rebuild unless it is at least 25% less expensive than a new alternative. The remanufacturer must therefore give a low quote for a job, normally prior to initial inspection of the core and then work back from that price to break-even and make a profit.

Important decisions to be taken regarding cost reduction include:

- How to price the product prior to inspection and yet stand a good chance of not losing the customer nor making a substantial loss?
- Having accepted the order, what criteria can be used to assess the condition of components to simultaneously minimise the use of new components as well as the risk of producing poor quality products?
- Given the importance of quality and reliability plus the high cost of inspection and testing, what is the minimum cost and type of quality control and quality assurance acceptable to the company?"

One of the main reasons that many customers choose remanufactured products is their shorter lead time. Lead time is defined as time elapsing between placing of order through to the completion of the product. How can the remanufacturer reduce his lead times without sacrificing his product quality?

Other problem issues include intellectual property rights restrictions. OEM's are often unwilling to provide remanufacturers with technical information about their products and the reverse engineering this situation necessitates can ramp up the cost of rebuilds.

Company C stated that IPR-related problems exist but are not one of its major hurdles because it has at least three engineers engaged in reverse engineering at any one time.

In this instance reverse engineering refers to the situation where a remanufacturer analyses a correctly functioning product to obtain information with which to rebuild it to the required specification on its failure.

Overall management view

According to Company C the major problem for the remanufacturer is in the decision making process. For example, how can he enhance the effectiveness and efficiency of decision making so that production costs are limited without sacrificing product quality? All major remanufacturing problems are related in some way to this main issue. For example one area of problem is in communication both within the company as well as between the company and its customers. To obtain orders the sales force must be able to precisely determine what the customer wants and this requires sound communication between the company and customers. At the same time to successfully fulfil the details of the contract the customer specification must be clearly understood and this requires good communication between the sales force and the production department. Ideally Company C

would prefer to carry out an initial inspection prior to accepting an order but the speed of response required in order acceptance does not allow it this privilege.

The author's observation about company C

The interviewer's impression is that the main issue for this remanufacturer is cost control and that this is determined by the efficiency and effectiveness of the decision making.

However, the decision making process is complicated because of the need to reconcile and balance contradictory requirements. For example, it must reduce both production costs and the level of new components used and simultaneously enhance product quality. Consider also the need to limit inspection, testing and other processing costs and yet enhance product quality. It would appear that it is from research into the decision making process in particular with regards to component assessment that the remanufacturer can gain the most benefit.

The company also confirmed that the major savings in remanufacturing occur through vastly reduced research and development costs in comparison to conventional manufacturing in addition to their reduced levels of bureaucracy. These advantages are said to result from the absence of extensive design, development and "actual" manufacturing activities in remanufacturing operations.

4.3.4: Company D

Company D is a transmissions remanufacturer with three UK sites and customers mainly from the U.K. It employs approximately 20 people and has a turnover of £0.5million per year. The general manager, supervisors and operators were the key informants during the case study. This company undertakes all three processes of remanufacturing, repairing and reconditioning, depending on the used product as well as on the customer's requirements

and financial circumstances. Where remanufacturing is concerned the used product is brought back to at least the OEM performance specification from the customer's perspective and is given an equivalent warranty. In the case of reconditioning and repair the work content is less extensive and the warranty given is also decreased to indicate this fact. Reconditioned products have an increased length of warranty than repair because they involve more work than repairing.

Company D's remanufacturing operation

In company D remanufacturing is undertaken on a jobbing basis and typically, one worker completes all the tasks required to remanufacture a transmission. This is because the company is very small and does not obtain adequate quantities of similar transmissions to warrant the use of batch processing. When a used product arrives it is given an initial examination to determine an approximate rebuilding cost. The customer is given a quote for repair, reconditioning and remanufacturing depending on his requirements. If the quote is accepted then company D begins the rebuilding program according to the activities shown in figure 4.5 and described below. Company D's remanufacturing operation can be divided into two groups, stages 1 and 2 activities.

Stage 1 activities

Stage 1 activities describe all the activities involved in cleaning and disassembling the core as well as initial component assessment and discarding obviously irreclaimable ones. It also involves thorough cleaning of potentially reusable components and their detailed analysis and rebuilding to the required specification. In this instance the component rebuilding is a term used by remanufacturers to describe the undertaking of repair-oriented tasks on components.

Figure 4.5: Company D's remanufacturing operation

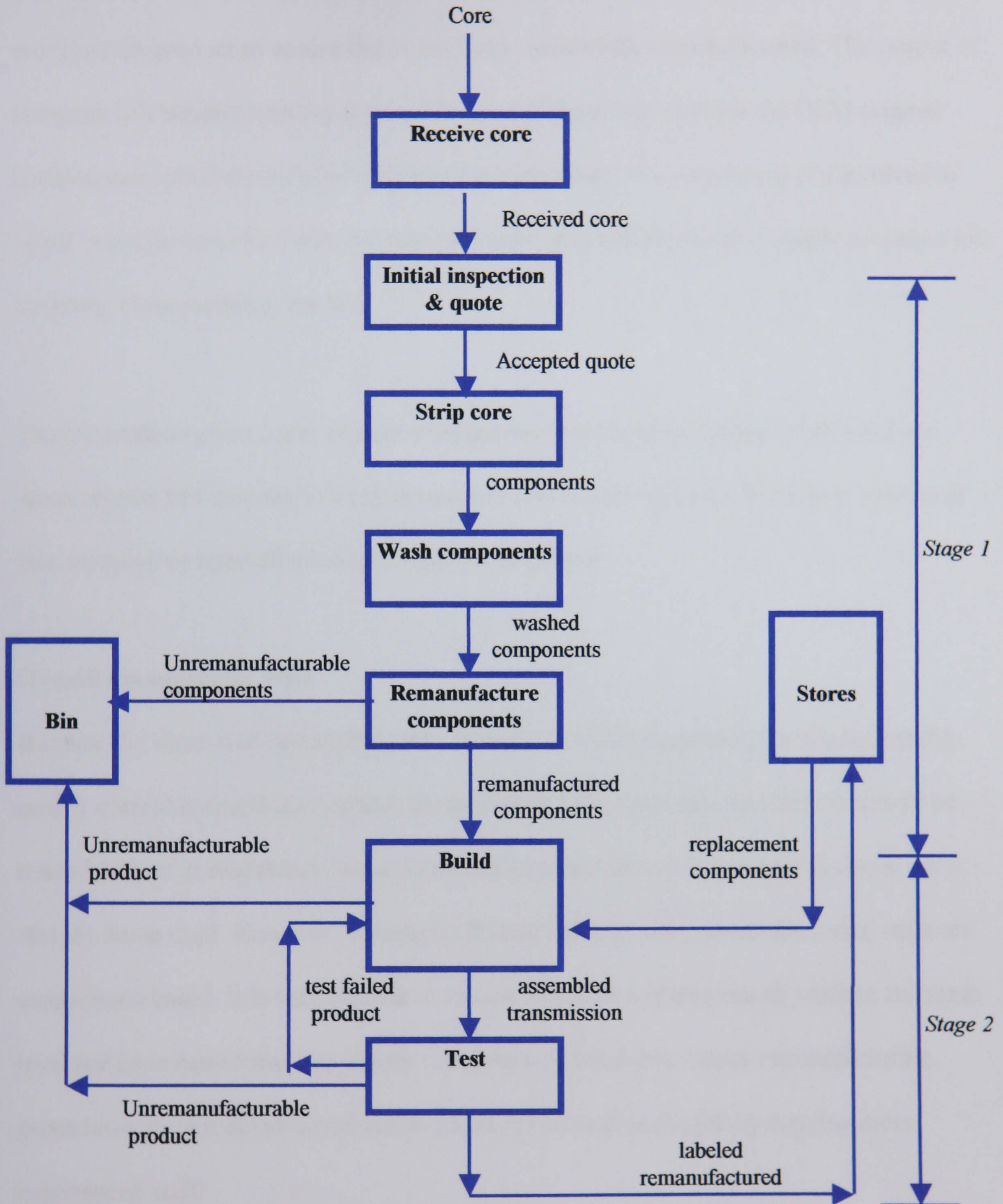

Stage 2 activities

Stage 2 activities describes the re-assembly of the transmission using an assortment of purchased new components and remanufactured components. It also includes the testing of the resultant product to ensure that it has been successfully remanufactured. The output of company D's remanufacturing process is a transmission that matches the OEM original performance specification from customers' perspectives. The company is not involved in "pure" manufacture but it may manufacture some very simple items to rapidly process a job, however, these instances are rare.

The information given under overall management view in the paragraphs following are direct reports of Company D's representatives and do not represent the author's views of that company or remanufacturing companies in general.

Overall management view

Because the success of remanufacturers depend upon their reputation for product quality, quality control is crucial throughout the remanufacturing process. All workers should be trained at least in elementary inspection techniques and should be alert for faults on parts that are being used. However, training is difficult because many remanufacturing tasks are experienced based. It is very difficult to ensure that your workers can all work to the same level and have been trained in exactly the same way because so many remanufacturing procedures are not documented and workers are trained on the job by copying more experienced staff.

In some remanufacturing organisations workers are expected to identify their work, for example, by colour or stamp to assist rapid fault tracing and training needs. Spot checking occurs frequently through out the process and critical components may be tested both

before input into stores and before recall to the shop floor. In a bid to develop expertise, a remanufacturer will limit complexity by specialising in a particular product or even class of product.

The key problem for remanufacturers is how to balance the contradictory needs for low cost, high quality and short lead time. These priorities are much more difficult to simultaneously obtain in a remanufacturing environment than in a conventional manufacturing operation because the remanufacturer is working with disused products and often without the original design specifications.

Other issues that complicate remanufacturing are the unavailability of tools and standards especially to assist effective component assessment and training. The problem is that the remanufactured product is simply what is inside it. If the components have not been evaluated properly, then you would not be able to remanufacture them properly because you don't know what is wrong with them. When you put them all together, to make up your product it just would not work properly and you end up making losses. It would help if there were some guidelines or even a commonly accepted idea of what remanufacturing is or should be.

The author's observations about Company D

This non-contract remanufacturer normally accepts whatever appears on their door. Because every job is different each must be assessed on its own merit so that an appropriate quote is given. Because of this the company is subjected to immense uncertainty. In addition to problems of maximising the reclaiming of parts, it has additional complications related to quoting speed and accuracy. This is because oversight in initial inspection and therefore in quoting can result in severe financial penalties whilst quoting latitude can lead to

opportunity loss. It makes very little use of IT because of two reasons. The first of these is financial constraints. There are few remanufacturing tools and software available commercially and company D lacks the financial acumen to design and develop such tools in-house. The variety of products it receives is immense so that it rarely obtains adequate batches of similar used products to make automation economically viable.

4.3.5: Company E

Company E specialises in the remanufacturing of open and semi-hermetic compressors for the refrigeration industry. It has three UK sites, each of which has approximately 25 permanent employees. Because its market is seasonal it uses part time and temporary workers to significantly increase its work force and in peak season each of the branches may accommodate up to 75 workers. It has customers worldwide mainly in Europe, Middle East and South Africa and a turnover of between £8 and £10 million per year. It has 2 distributors and holds 3rd position in its market in the UK where its share of the market is 17%. The general manager, supervisors and operators were the key informants during the case study.

Company E divides its compressors into two groups, “stock compressors “ and “customers’ own compressors”. Stock compressors are built for the company’s stock and are stored until purchased. Customers’ own compressors must be remanufactured and returned to the customer and have priority over stock compressors. Company E undertakes mainly remanufacturing jobs which it defines as returning the used product at least to OEM performance specification from the customers perspective. All company E’s remanufactured products are given warranties that are equal to that of the original OEM product. Company

E's remanufacturing process is illustrated in Figure 4.6. It is composed of the following activities.

Identification and introduction into company's system

Typically, each core will undergo initial cleaning and examination to determine basic information such as its condition, model and year of manufacture. The core is then tagged for identification and core details will be translated into the company's nomenclature. The information obtained here is entered into the company database along with customers' stated complaints where such information is available. At this point the compressor will also be identified according to its status i.e. "return under warranty" (returned by customers because its performance is below the expected standards), "customers' own compressor" (to be processed and returned to sender), or "build for stock" (to be processed and stored ready for resale).

The compressor's status determines the priority given to it as well as the costing and processing method that will be employed. For example, the processing for customers' own compressors begins with a customer fault report and price quote. If the customer accepts the quote, the company waits for a written job order before remanufacturing the compressor. Generally, costs for customers' own compressors are proportional to the compressors actual remanufacturing costs. Build for stock compressors, on the other hand, are given a nominal price irrespective of their remanufacturing costs and fault recording is undertaken simply to create or access experience data.

Typically, "return under warranty" and "customer own" compressors are processed by jobbing method and also have priority over build for stock compressors because their needs are more urgent. For example "customers' own" compressors must meet agreed delivery

dates while return under warranty compressors must be examined to ascertain blame or training needs.

Figure 4.6: Company E's remanufacturing operation

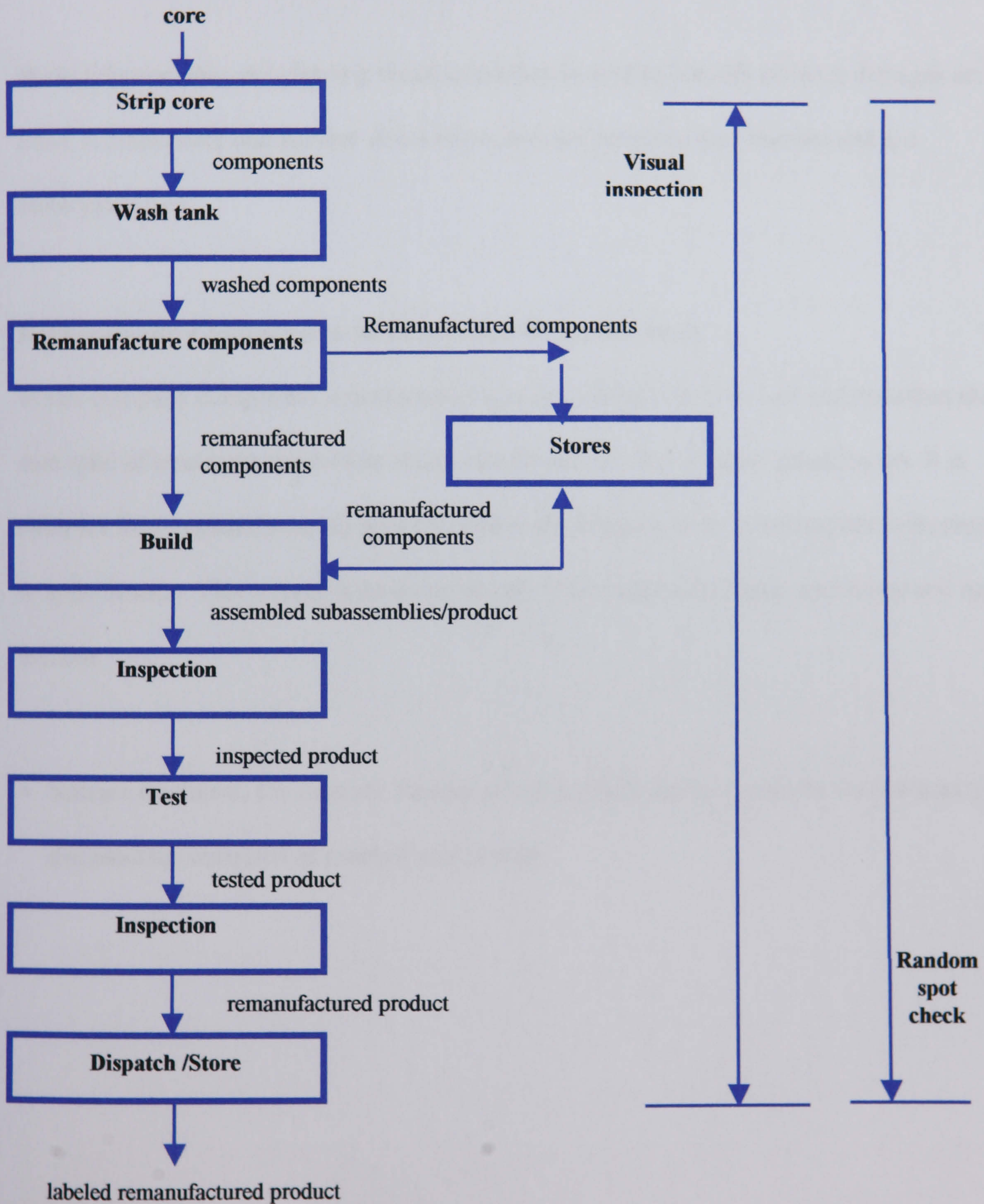

Disassembly and cleaning

Following their input into the company system, identical cores are grouped into batches and disassembled. Disassembly of large compressors may occur in stages: first by subassembly and then into smaller components. With the exception of components that are always discarded (e.g. gaskets), every component is thoroughly cleaned.

During disassembly and cleaning visual inspection is used to identify obvious damages and flaws. Components that survive visual inspection are sorted by part number and are remanufactured.

Remanufacture components and input into inventory stock

In this company component remanufacturing is also called refurbishment and describes the sum total of treatment required to return components to their original specification. It is different from remanufacturing which describes the bringing back of a complete compressor to specification. This activity is an essential part of the remanufacturing operations and may involve:

- Surface treatment, for example blasting or rolling in abrasives to restore the surfaces of discoloured, corroded or painted components.

- Mechanical and electrical treatment, for example metal spraying, welding and machining to build up worn parts to original dimension. Distorted holes may be enlarged to take an insert with the correct internal diameter and bent shafts may be hammered or coaxed into shape.

Other component remanufacturing activities include resetting of internal gauges and rewinding of motors. Subcontracting may be used to reduce costs or improve quality.

In the interest of economy, the process chosen for the remanufacturing program will depend on the type of compressor and the volume of work involved. However, some customers' own cores and warranty returns may be processed by jobbing irrespective of their work content. The reason here is to ensure accuracy and consistency of fault reporting and costing.

Rebuilt parts that pass the mechanical and electrical tests are labelled and put into parts inventory in stores. Generally the inventory record does not differentiate between remanufactured parts stock and new purchased parts because these are considered equal in quality. Replacements for items that must be discarded are ordered from suppliers and these are also put into the inventory stock.

Testing, measurement and quality control

The testing, measurement and quality control methods used are similar to those of the original manufacturing. The only difference is that remanufacturing requires 100% inspection because in remanufacture all parts are presumed faulty until proven otherwise. Once all required components are available in stores assembly kits are prepared in stores using an assortment of remanufactured and purchased components according to the

production schedules. These kits are called out to the assembly area as required for subassembly and final assembly. Assembly is followed by whole system testing of the compressor to ensure that its performance standards are equivalent to the OEM original specification from the customer's perspective. If the compressor passes the testing process then it is painted and labelled in a way that clearly distinguishes it from a new compressor.

Finally it is given a warranty that is equivalent to that of the original compressor and is shipped to a customer or else put in finished goods stock to await purchase.

The information given under critical issues, key problems and overall management view in the paragraphs following are direct reports of Company E's representatives and do not represent the author's views of that company or remanufacturing companies in general.

Critical Issues

The priorities for the business are:

- High reliability and quality to be able to compete in the market.
- Speed and consistency of delivery as well as low cost to be able to beat competitors and secure orders. Also secondary market products whether reconditioned or remanufactured must be much lower priced than new alternatives to attract customers.

The business depends on its reputation for service to survive so if resource is not available it will purchase new components and remanufactured ones from its competitors rather than disappoint a customer. On occasions it has been forced to purchase remanufactured compressors to fulfil accepted orders and incur losses rather than risk losing the favour of its customers.

Key Problems

The major remanufacturing problem is uncertainty. Even when contracts are available it is impossible to precisely forecast the quantity and type of cores that will be received. For example, although the company has contracts it is still impossible to predict when customer's compressors will fail and this makes it impossible to plan resource requirement. This company tries to forecast resource requirement based on past experience. Also, like many compressor remanufacturers it keeps a bank of casual and temporary labour because its market is seasonal. Even with all these precautions, it can never accurately predict the quantity of work offers it would receive.

For example in a recent two-months period we were forced to turn away more than £65,000 worth of trade because we were not expecting them and no matter what we did there was no way that we could get together the stuff we would need to complete them on time. It is impossible to guarantee a customer that a similar replacement for his equipment will be in stock ready for shipping or even that the body, spares and labour will be available for remanufacturing an appropriate equipment on demand. Also, product history is normally unavailable and this increases the effort and time that remanufacturing would otherwise require.

Overall management view

Customers demand short delivery times, low product cost and high product quality but it is difficult to meet all these requirements at the same time because the methods you use to improve one requirement may also reduce your performance in another. For example, reducing component testing and inspecting time may reduce production cost and remanufacturing lead-time but may also reduce product quality simply because if you get it wrong with the component you get it wrong with the whole product. It is also difficult to

introduce effective training and performance measures because remanufacturing is an experience-based process and documentation and tools are few and far between. For example, it would be impossible to measure scrap levels unless individual workers are willing to own up when they damage components. It seems impossible to effectively predict acceptable scrap level when a business is working with scrap. Each core is different because outward appearance and age cannot accurately dictate the condition of the internal components and their extent of wear. Tools are often made in-house and vary between companies and sometimes between individual operators within a given company. There are few guidelines so the attitude in this business is if it fits use it. Cost reduction is a great problem for remanufacturers. The simple fact is that no matter the quality of a used product, no one in his right mind is going to be willing buy it for the same price as a new alternative. We simply have to charge much less than OEM companies if we want to get the customers. The problem is how can we do this and still consistently offer at least the same quality.

The author's observations about Company E

In this company a test was undertaken to assess the effectiveness of component evaluation. This involved putting discarded components back into the production process. The test results was that, following re-inspection of the discarded components operators passed a significant proportion of the components that they had previously failed.

Other observations include:

Effect of contracts on the level of uncertainty

Contracts act as buffers against uncertainty for this company by:

- Reducing the variety of product types or at least making known the variety of products that would normally be received. This is because a contract generally states the product types it covers.
- Specifying the type and level of work that must be carried out on particular components. For example there may be a list of components that must always be discarded whatever their condition. This determines in advance the prognosis for a significant proportion of components and therefore reduces the number of decisions that company E must make.

In comparison to an independent remanufacturer uncertainty is less of an issue for this contract remanufacturer. It knows the types of units that will be received and often the quantities and time of arrival of products. It also knows in advance how much it will charge for the rectification of particular machines because the contract stipulates an agreed sum. The quoting activity is omitted in its remanufacturing operational diagram. Additionally, because its clients often are original equipment manufacturers, it can easily obtain spares. In fact, the OEM insists that only its genuine spares are used in remanufacturing its used products. Because of this the contract obliges the OEM to release spares as and when required to company E. The main source of uncertainty for company E is ignorance about the quality of cores prior to their disassembly. Its major problem is how to effectively and consistently judge the suitability of reclaimed parts for reuse. That is having disassembled the product what strategies can and should be used to ensure maximum reclaiming of parts as well as limited operation lead-time and high product quality.

4.4 Analysis of the Phase 1 case study evidence

The Phase 1 case studies revealed two types of remanufacturing business issues. The first of these are the key problem causes in remanufacturing operations and are shown in Table 4.1.

The second is the characteristics that remanufacturers believe that they require in order to stand a good chance of succeeding and are presented in table 4.2.

4.4.1 Contract and independent remanufacturers

It was observed that contract remanufacturers, for example Company E typically do not have the quoting activity in their remanufacturing operational flowcharts. Such companies quote only when they undertake non-contract jobs. Independent remanufacturers, for example Company D typically have the quote activity in their operational flowcharts. Non-contract remanufacturers also appear to experience difficulties in obtaining parts from original equipment manufacturers and, generally, they operate via jobbing process because of the variety of product types that they serve.

4.4.2 The key remanufacturing problems

Table 4.1 illustrates the range of remanufacturing problems recorded during the Phase 1 case studies from these it can be seen that the major ones are uncertainty, lack of remanufacturing-specific tools and guidelines and over reliance on experience. In fact evidence from the companies indicate that over reliance on experience is a direct result of problems related to the paucity of remanufacturing tools and guidelines and that these two problems also cause inconsistency in training. The evidence given in Table 4.1 also indicates that component assessment is critical in remanufacturing operations.

Table 4.1: Summary of remanufacturing problems

Problems Identified	A	B	C	D	E
Uncertainty	Very significant	Very significant	Not significant	Very significant	Fairly significant
Component inspection		Critical	Critical	Critical	Critical
Lack of specific tools		Very significant		Very significant	Very significant
Lack of remanufacturing guidelines		Very significant		Very significant	Very significant
Over reliance on experience		Significant		significant	Very significant
Inconsistent training				Very significant	Very significant
Difficulty in reducing supplier base	Very significant				
Difficulty in forecasting acceptable component inventory		Significant			
Short Lead time		Very significant	Very significant	Very significant	Very significant
IPR			Fairly significant		Fairly significant
Communication			Significant		
Lack of documentation of remanufacturing procedures		Significant		Very significant	

Scale showing significance of problem to successful remanufacturing:

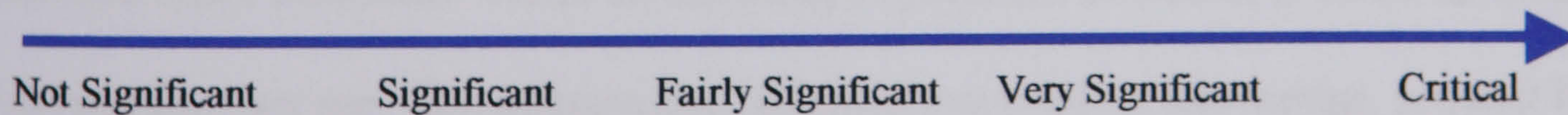

Table 4.2 lists the major characteristics that remanufacturers believe are important to their companies.

4.4.3 The key remanufacturing success factor

Table 4.2: Desirable characteristics for remanufacturing operations

Desirable characteristic	A	B	C	D	E
Flexible staff	Critical	Important		Critical	
Quality products	Very Important	Critical	Critical	Critical	Critical
Low price products		Very Important	Important	Extremely Important	Very Important
Short lead time		Important	Important		Very Important
Product knowledge		Very Important	Important	Very Important	
Technical skills		Critical	Critical	Critical	
Product history		Very Important			

Scale showing importance of factor to successful remanufacturing:

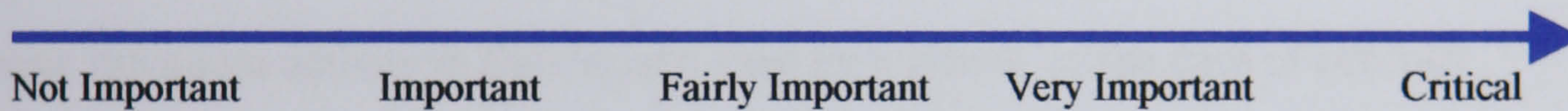

As can be seen from table 4.2 a key requirement for remanufacturers is the ability to produce high quality products that are also low in price. This is because remanufacturers believe that their products must be less expensive than new alternatives because customers would not purchase a used product if its price is similar to that of the new alternative. They also believe that remanufactured products must also be high quality to attract buyers because many customers would be unwilling to purchase unreliable product no matter how inexpensive they are. The diagram also indicates that product knowledge, product history and technical skills are also important assets for them. This logically follows because such assets are required to be able to produce high quality products. The fact that most remanufacturers value flexibility in their workers is also logical because flexible workers are more likely to cope successfully with the uncertainty of the remanufacturing environment.

Additionally, flexible workers may also help to lower production costs because they are capable of undertaking a wide range of tasks and this may help to reduce the number of workers that the company requires.

4.5 Summary

This chapter has presented the Phase 1 case study method as well as each of the Phase 1 case studies. It has presented the remanufacturing operational flowcharts of the companies and it has described each company's remanufacturing procedure. It has also summarised the main remanufacturing problems of the companies as well as the characteristics that they believe that they require in order to succeed. The chapter also recorded that the operational flow charts for contract and independent remanufacturers are different. This is because evidence from the Phase 1 case studies showed that independent remanufacturers typically have the quote activity in their operational flow charts. In the case of contract remanufacturers the quote activity is absent and is only introduced when the contract remanufacturers undertakes non-contract jobs or wishes to renegotiate an existing contract.

The following chapter presented in the conclusions of the Phase 1 case studies.

Chapter 5: Overview of remanufacturing practice

5.1 Introduction

The previous chapter presented the individual Phase 1 case studies. This chapter describes the conclusions of those studies. This will involve:

1. Presenting and describing a standard flow chart of the remanufacturing operation that the author has developed through the research.
2. Describing the characteristics of typical remanufacturing operations.
3. Explaining the primary production control issues in remanufacturing operations.

5.2 The generic remanufacturing operational flow chart

From the descriptions of the remanufacturing operations of all the Phase 1 case study companies, it can be seen that remanufacturing begins with the arrival of a used product (called a core) at a specialist facility (the remanufacturer's). In this factory environment cores pass through a series of industrial stages which include disassembly, cleaning, component remanufacturing, replacement of unremanufacturable parts, re-assembly and testing to produce the remanufactured product.

The importance of quality assurance to successful remanufacturing is shown by the dominance of inspection and test procedures as indicated in the process diagrams of companies A, B, C, D and E. Even without including the inspection procedures carried out by non-inspection staff, inspection and test account for a significant proportion of remanufacturing activities.

Of the five classical process choices (Hill, 1996) it would appear that only two, batch and jobbing are available to the remanufacturer. The case study recorded no instances of the use of the project production method. This may be because typically that method requires the job to be a one-off and often too large to be moved whereas remanufacturing appears to prefer products that are factory built rather than field assembled. Line processing also appears to be inappropriate because it is generally used to process high volume products with stable processing needs. Remanufacturing however, would typically not provide such large numbers and stability.

Figure 5.1 illustrates a generic flow chart of the remanufacturing operation that the author has determined through the Phase 1 case studies that were described in chapter 4. It consists of the following activities.

5.2.1 Receive core

The Phase 1 case studies described in the previous chapter have indicated that typically, in remanufacturing operations, the core undergoes initial cleaning and examination to determine basic information such as its model and year of manufacture. If the company has access to a sound information system the cores will be tagged for identification and core details will be entered into the company database.

Figure 5.1 A generic remanufacturing operational flow chart

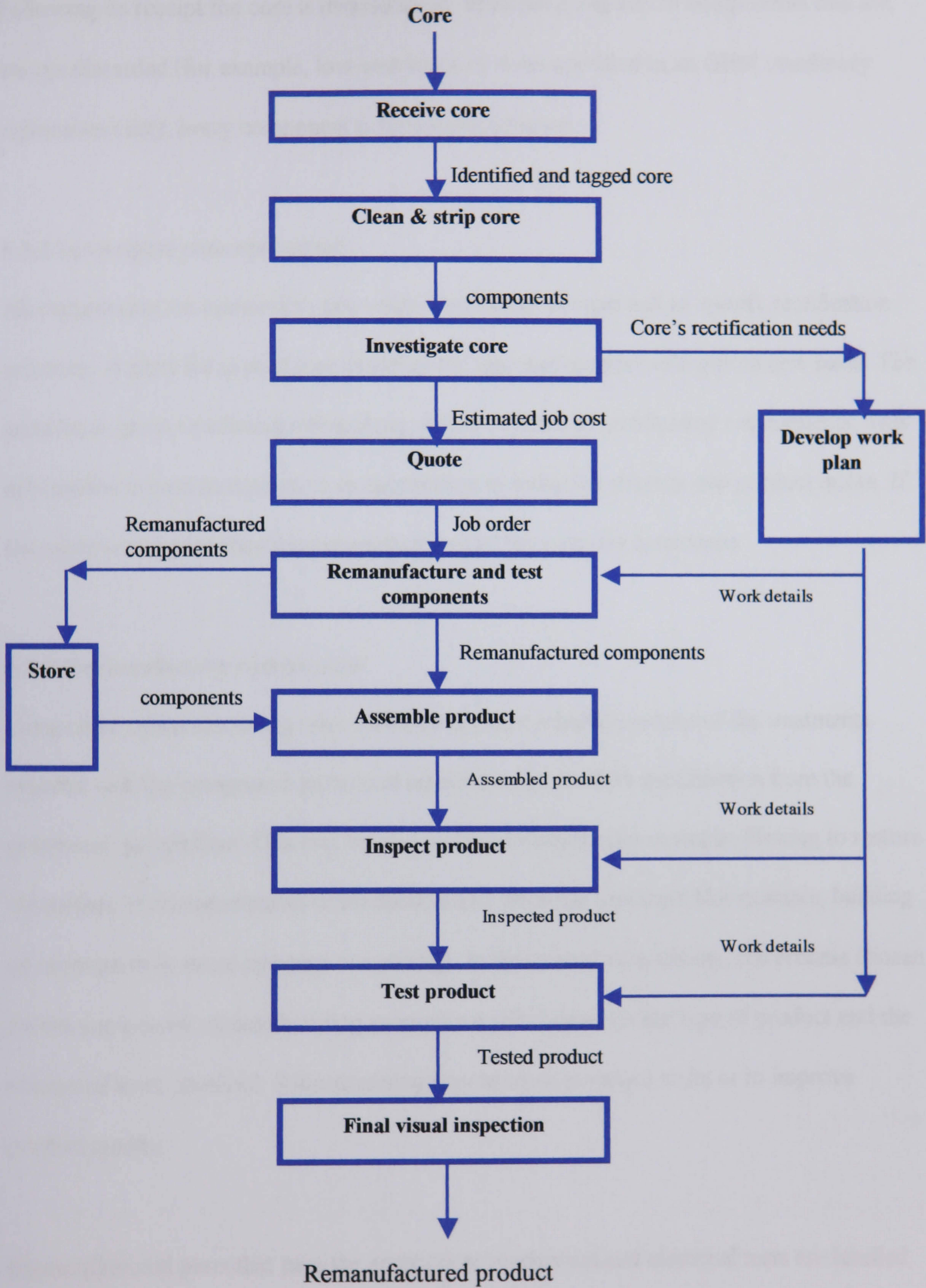

5.2.2 Clean and strip core

Following its receipt the core is disassembled. With the exception of components that are always discarded (for example, low cost items or items specified in an OEM mandatory replacement list), every component is thoroughly cleaned.

5.2.3 Investigate core and quote

All components are assessed to determine their extent of wear and to specify rectification solutions. A parts list is produced detailing the type and quantity of required new parts. The parts list is given to administration along with the details of rectification requirements. This information is used to determine an appropriate rectification strategy and product quote. If the quote is accepted then the remanufacturing of the core can commence.

5.2.4 Remanufacture components

Component remanufacturing (also called component rebuild) consists of the treatments required to bring component parts to at least the original OEM specification from the customers' perspective. This may involve surface treatment (for example, blasting to restore the surface of corroded parts) or mechanical and electrical treatment (for example, building up worn parts by metal spraying or welding). In the interest of economy, the process chosen for the component remanufacturing programme will depend on the type of product and the volume of work involved. Subcontracting may be used to reduce costs or to improve product quality.

Remanufactured parts that pass the appropriate mechanical and electrical tests are labelled and put into parts inventory in stores. Generally the inventory record does not differentiate between remanufactured parts stock and new purchased parts because these are considered

equal in quality. Replacements for items that must be discarded are ordered from suppliers or made by the remanufacturer. These are also put into the inventory stock.

5.2.5 Assemble and test

Once all required components are available in stores, assembly kits are prepared using an assortment of remanufactured, purchased and manufactured components according to the production schedule. These kits are brought out to the assembly area as required for subassembly and final assembly. Assembly is followed by whole system testing of the product to at least the original OEM performance specification from the customers' perspective. If the product passes this final test then it is surface finished, (for example, by painting). Following this, the product is labelled in a way that clearly distinguishes it from a product newly produced by conventional manufacturing.

Finally the remanufactured product is given a warranty which is at least equal to that of an equivalent product at the OEM original specification and is shipped to a customer or else is put in finished goods stock to await purchase. The testing, measurement and quality control methods used are similar to those employed during the original manufacture. The only difference is that in remanufacturing inspection is much more rigorous. In fact inspection must be on a 100% basis because in remanufacturing all parts are presumed faulty until proven otherwise.

The following sections will describe some characteristics of remanufacturing operations that were revealed by the Phase 1 case studies.

5.3 Characteristics of remanufacturing business operations

The case studies revealed that the major problems facing remanufacturers are caused by uncertainty, intellectual property rights restrictions (IPR) as well as the complexity of the decision making process.

5.3.1 Uncertainty

The main source of uncertainty in remanufacturing is ignorance of long and short-term requirements. An example of long-term requirements would be the level of resource that would be required in a particular future period. Short-term requirements describe issues such as predicting the level of resource that would be required to remanufacture a core that the company has received but has not disassembled. This situation is caused by problems such as the inability of remanufacturers to predict the quantity and quality of in-coming products as well as problems related to intellectual property restrictions (IPR). These complicating factors are explained below.

5.3.1.1 Inability to predict the quantity of cores that will be received

The Phase 1 case study companies, for example company B, state that it is usually impossible for them to determine when customers' products will fail, therefore they cannot precisely forecast resource requirements. Company E stated that it had been forced to reject trade offers worth more than £65,000 because their unexpected arrival did not allow it scope to obtain the resource it needed to process the job orders. This problem is even greater for remanufacturers that have no contracts. These companies face significant uncertainty regarding the product types that they will receive.

According to company E, even when the remanufacturer has contracts, it will still obtain jobs from other sources and it cannot forecast this non-contract work. Additionally,

forecasts of contract work may not be accurate because of unforeseen circumstances and communication problems. The Phase 1 case study companies indicate that a common problem in this area is the unexpected arrival of products and the arrival of products differing significantly from the expected versions.

5.3.1.2 Inability to predict the quality of incoming cores

According to the Phase 1 companies, for example companies E and A, the quality of a core is determined by its service history and operating condition rather than by its age or cosmetic appearance. However, information on the product's service history is often not available. They state that because of this remanufacturers are unable to determine the remanufacturing needs of cores prior to their disassembly and inspection (i.e. the start of the remanufacturing operation) and that this makes it difficult for them to plan resource requirement on the basis of accepted jobs.

5.3.1.3 Intellectual property rights

The case study findings, for example the information from companies C and D indicate that OEM's are often unwilling to provide remanufacturers with technical details about their products and the reverse engineering that this situation necessitates can increase both remanufacturing cost and production lead time. In this context reverse engineering describes the situation whereby a remanufacturer analyses an OEM product in order to determine a specification that can be used when the product fails in order to return it to OEM original performance specification from the customer's perspective. According to company A remanufacturers may also have difficulties in reducing their supplier base. This is because producers of components for some old product designs are scarce. The remanufacturer is therefore tied to these suppliers no matter how inconvenient and unreliable the supplier may be.

5.3.2 Pricing

According to company C for example, customers would not usually purchase a remanufactured product unless it is at least 25% less expensive than a new product.

Company E states that this is because in order to win customers, secondary market products such as remanufactured goods must be low priced in comparison to new alternatives.

Therefore the market predetermines the range of prices at which a remanufacturer can sell its products. The remanufacturer must give a low quote for a job and then work back from this price to break-even and make a profit. All the Phase 1 case study companies believe that pricing strategy is one of the most important and difficult decisions for a remanufacturer. Companies D, B and E believe that the reason for this is because core inspection is time consuming and costly, especially if the customer later declines the quote. At the same time remanufacturers are often forced to quote prior to core inspection because customers expect high speed of response in order acceptance.

Companies B and C indicated that remanufacturers would prefer to inspect cores prior to quoting, however the speed of response required in order acceptance and the loss that would be sustained if the customer declined the quote following a detailed core analysis do not usually allow them this luxury. Remanufacturers therefore experience difficulty in quoting prior to inspection without incurring substantial losses.

5.3.3 Core assessment criteria

All the Phase 1 case study companies state that generally, remanufacturers have great difficulty in evaluating the suitability of reclaimed parts. They state that this is because there are few standards and methodologies to aid consistent and accurate core assessment. This problem reduces the effectiveness and efficiency of production and ultimately has a profound impact on the profitability of remanufacturing businesses.

5.3.4 Quality control

While poor quality will be disastrous to a remanufacturer excessive testing and inspection can have adverse effects such as long production lead-time and high production costs and both of these can result in bankruptcy. As a result remanufacturers have difficulty in deciding how to balance the needs of high quality and reliability with the requirement for low cost products and short production lead-times as has been illustrated from the information obtained from companies B, E and D.

5.4 Primary production control issues in remanufacturing.

The main production control issues highlighted by the research relate to the “investigate core” activity and its “assess component” sub-process.

5.4.1 The “investigate core” sub-process.

As has been shown by the Phase 1 case studies, for example company C, the “investigate core” activity is the key fault analysis stage in the remanufacturing operation. This activity consists of a series of component assessment sub-processes where components are evaluated to determine their extent of wear and to specify their rectification requirements. The “investigate core” activity also involves producing a list of the types and quantities of new parts that must be purchased or manufactured to replace components that cannot be brought to the required specification. Additionally, the information obtained by this activity is used to determine an appropriate job quote.

Because of these reasons, the “investigate core” activity requires effective and reliable systems for gathering and evaluating data. It demands effective trouble-shooting to ensure that valid rectification solution and accurate cost estimates can be ascertained.

The case studies have shown that a crucial element of the remanufacturing operation is the ability to effectively diagnose the faults of failed products, i.e. effective product failure analysis.

All the companies surveyed could cite examples where financial losses occurred as a result of inadequate initial analysis. This can be illustrated through the experience of company B, a remanufacturer for the quarrying industry as described in the previous chapter in section 4.3.2.

5.4.2 The “assess component” activity

The “assess component” sub-activity is a fundamental component of the “investigate core” activity and is critically important to the overall economic viability of the remanufacturing operation. This sub-process is the making of decisions regarding the suitability of components for reuse. This was shown in companies B, C, D and E.

The case studies have revealed that this sub-activity underpins the “investigate core” activity and adds significantly to its complexity. This is because core investigation involves the examination of the quality of the components that make up that core. Inadequate component assessment can have significant negative financial repercussions, for example through the discarding of good components and the use of inappropriate labour.

Despite the significant adverse consequences of performing the “assess component” sub-process insufficiently, there appear to be few guidelines to assist accurate component evaluation. As a result, important decisions regarding component quality rest almost entirely on the expertise and good will of operators. Companies B and D, for example, stated that they are extremely reliant on the experience of their workers because there are few tools to

available to assist effective component assessment. Also, company B gave examples of the extent of loss it has incurred because of inadequate performance in that sub-process. Some of the problems resulting from this lack of standard policies and procedures include inconsistency of component inspection, excessive waste, poor performance monitoring and inadequate training. In the case of inadequate training, company D, for example indicated that it found it difficult to give workers the same training because so many remanufacturing procedures are not documented so that training consists of new recruits simply copying more experienced workers. As far as excessive waste and poor performance monitoring is concerned company E, for example, stated that the paucity of guidelines and documentation makes it difficult to monitor performance and predict acceptable scrap levels unless workers are willing to own up when they make mistakes.

Performance monitoring is inadequate because without a company wide accepted and documented work approach it is difficult to select appropriate criteria against which to measure the work of operators. Training is often ineffective and inefficient because in the absence of clear documented criteria and standards, poor component assessment practices may be passed on to new recruits. This was shown in companies B, D and E.

Other observations made by the Phase 1 case studies relate to the influence of production volumes and contracts on remanufacturing operations and also to the relationship between manufacturing and remanufacturing companies. These issues are explained below.

5.5 Effect of production volume and contracts on remanufacturing operations

The research determined that volume of activity has great influence on the production process adopted by remanufacturing concerns. Large quantities normally increase the opportunity to obtain generous batches of similar units. It can thus permit cost reduction strategies such as line processing, automation and tasks deskilling. On the other hand, the

immense variety that typically characterises small scale remanufacturing would render such schemes impractical if not impossible. Small volume remanufacturing therefore generally necessitates jobbing process and relatively skilled labour because each operator must process a variety of machines to completion without supervision.

Contract and non-contract remanufacturers have diverse requirements. As the choice of business system is directed by business needs the operational diagrams for both types of remanufacturer are dissimilar. An example of an obvious difference is the omission of the quoting activity in the operational flowcharts of contract remanufacturers. For example, Company B undertakes both contract and non-contract work. When contract work is undertaken the quoting activity is omitted because the contract stipulates an agreed job cost. However, in the case of non-contract jobs, the company undertakes a preliminary examination to determine a job cost. This cost is given to the customer as a quote and the remanufacturing operation does not begin until the customer sends the company a job order to indicate that the quote has been accepted.

With regards to organisational size and production volume the research information indicates that large remanufacturers commonly have greater volumes of activity than their smaller rivals. The evidence also suggests that large remanufacturing companies tend to be those that either have contracts or else operate in a niche market. In fact it would seem that the acquiring of contracts leads to increase in both organisational size and production volume. Additionally, because of their greater production volume, superior financial position, and often support from OEMs, larger remanufacturers are likely to have greater IT resource than independent remanufacturers. This can be illustrated by comparing the remanufacturing operations of companies D, E and C. Company D is an independent remanufacturer that does not operate in a niche market. It is small and makes little use of IT

partly because of financial constraints and also because it rarely obtains adequate volumes of similar products to make automation viable. Company E is a contract remanufacturer. Because of the large quantity of jobs that it receives through its contracts it has adequate resource to implement IT techniques. Its contracts also guarantee it large volumes of similar products and this makes economies of scale such as batch production and automation viable. Company C on the other hand operates in a niche market. Its customers have few options and often compete for its services simply because it has few competitors. As a result it also receives many jobs and large volumes of similar products. Because of this it also is a large remanufacturer that can afford to purchase new technology and take advantage of economies of scale.

5.6 The relationship between manufacturing and remanufacturing companies

From the author's observations it would appear that once a remanufacturer attains a certain size and remanufacturing expertise it may become capable of designing the products it remanufactures. In such instances the remanufacturer typically moves into the manufacturing arena thus challenging the OEM manufacturer on two levels. This was shown in companies B and C. Even more disastrous for the manufacturer is that such remanufacturers inevitably bring with them all the benefits of remanufacturing experience such as expertise in limiting research and development costs, for example, reverse engineering and the "ability to understand and interpret the whole picture when given a few threads". Such skills are thrift based and ensure the remanufacturer's capability to severely undercut conventional manufacturers.

5.7 The major source of savings in remanufacturing operations

The companies also confirmed that the major savings in remanufacturing occur through vastly reduced research and development costs. The operational charts of the

remanufacturing companies illustrated that typically remanufacturing companies do not undertake research and development. This is also shown on the manufacturing V remanufacturing operational charts on figure 5.2. The remanufacturing companies interviewed indicated that the absence of extensive design, development and “actual” manufacturing activities in remanufacturing operations gives them additional advantages such as reduced levels of bureaucracy.

5.8 The new definition of remanufacturing

The proposed new definition of remanufacturing is that it is a process of returning a used product to at least OEM original performance specification from the customers’ perspective and giving the resultant product a warranty that is at least equal to that of a newly manufactured equivalent. This is because evidence from the Phase 1 case studies indicate that remanufacturers not only return the used product to at least OEM original performance specification from the customers’ perspective but also give that product a warranty that is at least equal to that of a newly manufactured equivalent.

Figure 5.2 Manufacturing V remanufacturing operational charts

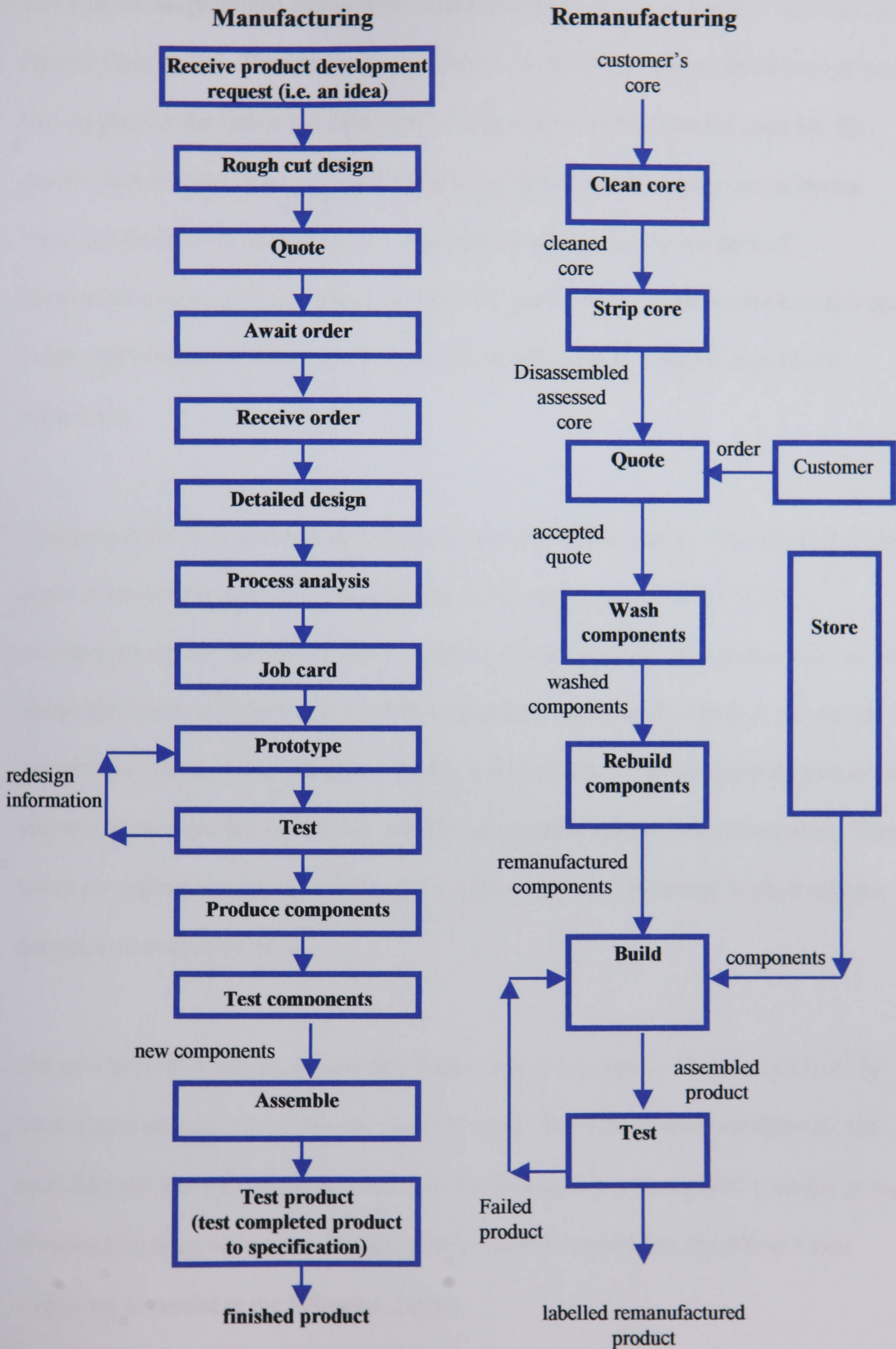

5.9 Summary

This chapter has presented an overview of current remanufacturing practice observed by the Phase 1 Case studies. This included a description of the generic remanufacturing operational flow charts that the author has developed using the information from the research. The generic flow charts showed that remanufacturing operations share some key activities. These are disassembly and cleaning, component rebuilding and replacement of unremanufacturable parts and finally re-assembly and testing to produce products that have similar performance specification to the original OEM product from the customer's perspective.

The case studies also showed that remanufacturing operations can be characterised by their major production control issues and that these are related to uncertainty of their environment and the complexity of the decision making process. These production control issues are discussed in Section 5.4. Other observations made by the Phase 1 case studies relate to the influence of production volumes and contracts on remanufacturing operations and also to the relationship between manufacturing and remanufacturing companies. These issues are explained in Sections 5.5 and 5.6. This chapter also presented a proposed new definition of remanufacturing.

The next procedure was to validate the Phase 1 case study results. This was achieved by discussing them with academics and non-case study remanufacturers at conferences and trade fairs and also by comparing them with the findings from the study of a second group of remanufacturing operations. Details of these second case studies, the Phase 2 case studies are presented in the following chapter.

Chapter 6: The phase 2 case studies

6.1: Introduction

This chapter describes the phase 2 cases. These are the in-depth four-week cases that were used to validate the Phase 1 case study findings. Because all the case studies of this research were undertaken using similar overall procedures, this chapter presents only the individual Phase 2 cases. However, the reader is urged to refer to chapter 4, section 4.2 for a description of the case study procedure if this is required.

Before these studies, the Phase 1 case study results were confirmed by discussing them with remanufacturing practitioners at trade fairs and conferences. Organisation G was chosen for these case studies because at its UK head quarters it has five remanufacturing operations as well as a sister company, company H, in close proximity. All these operations are independent and have different characteristics. For example, there were large and small companies as well as contract and independent ones. These dissimilarities permitted the author to explore the operations of a range of remanufacturing practitioners over an extended period with relative ease. Company F was selected because it is unrelated to organisations H and G and also rebuilds an unrelated product. Organisations H and G are concerned with transmission and related products such as transmission converters but company F rebuilds only refrigeration compressors. This precaution helped to ensure that organisation and product-specific factors would not influence the outcomes of the validation of the Phase 1 case study results.

6.2 The Case study organisations

Company G

Company G is an international supplier of new and remanufactured transmissions systems, electronic control units (ECU's) and replacement parts. The company has markets in the UK, U.S.A, Europe, Far East and Middle East. It has six branches, three in the UK and one each in France, China and Holland. The company has 180 employees at its UK head office and an annual turnover of £8M. It has both ISO 9002 and QS 9000 and at the time of the case study was planning to pursue ISO 9001 provided that its design work continued to expand.

Company G began life in the UK in the mid 1960's as an automatic transmissions re-manufacturer. Because of its professional approach and heavy investment in specialised equipment the company grew rapidly. By 1980 a separate division was introduced to service the growing demand for high quality industrial and off-road equipment remanufacture. Trading bases were also established in France, Holland and China.

The company's steady growth and solid reputation prompted its appointment as a major remanufacturer for several original equipment manufacturers. Company G became the European distributors of new automatic transmissions and trans-axles for the Chrysler/Acustar Corporation of Detroit and it regularly adapt their products for special uses like city buses, airport ground support vehicles, tracked vehicles and construction equipment etc. From the initial design and development to the manufacture and final installation of complete transmission systems, Company G is well known for the quality and reliability of workmanship that today's vehicle manufacturers demand.

The introduction of electronics into the automotive industry brought many significant changes to the modern motor vehicle and Company G embarked on major reorganisation to meet this challenge. For example, a company dedicated to the remanufacturing of automotive electronic systems, was added to the group and is now established as a major authority on the subject. Their expertise and unparalleled knowledge of all types of vehicle electronics is also available world-wide via their unique, on-line diagnostic system known as Network 500 Ltd. Company G guarantees to complete jobs within 30 days, irrespective of the numbers of cores involved and provided that required components can be obtained.

During the case study company G's representatives were the Chairman and vice-chairman, the manufacturing director, the supervisors of the five operations studied, the quality manager and some operators.

6.2.1 Overview of Company G's UK headquarters

At its UK headquarters Company G has four operations, G1, G2, G3 and G4 that are devoted to the remanufacturing of non- industrial transmissions. Operation G1 remanufactures only the major customer's forward drive transmissions, operation G2 remanufactures various transmissions, operation G3 remanufactures the major customer's rear wheel drive transmissions and operation G4 remanufactures the major customer's manual drive transmissions.

All these operations are independent of each other. Each remanufacturing operation has a unique cost centre because of differences in the nature of their inventory. For example, the costs associated with operation G1 must be isolated from that of the other operations firstly, because it has bonded inventory and, secondly, because of its contractual obligations. For

example, its customer insists on an extensive mandatory replacement list plus the use of his own genuine spares for remanufacturing his cores.

They also use different production processes because of dissimilarities in the variety and volume of the transmissions types that they receive. For example, operation G1 receives large quantities of similar transmissions from a unique customer and can economically use line production processing while operation G2 that serves a diverse set of transmissions and clientele must operate via jobbing process.

Converter subassemblies from transmissions being remanufactured at all four operations are remanufactured by G5, a torque converter remanufacturing operation. G5 is also owned by Company G and is responsible for all the converter remanufacturing needs of all the remanufacturing operations at Company G's UK headquarters. It uses batch production and is located in close proximity to the four transmission remanufacturing operations but is independent from them.

6.2.2 Brief description of Company G's remanufacturing operation

Required transmission cores are taken from the received cores area and split into converter sub-assemblies and main transmissions sub assemblies. Converters are labelled according to their type and stocked at the received converter storage point at the back of the received cores area where they are held until they are collected for processing by operation G5 employees. The main sub assemblies, the transmissions, are similarly labelled by production control but are delivered to the appropriate transmissions remanufacturing operation.

Converter sub-assemblies and the main transmissions sub-assemblies are remanufactured and examined independently in their respective remanufacturing areas. They are then delivered, again separately to the test rig where test personnel couple (assemble) them prior

to whole system testing. Transmissions that pass whole systems testing are sent to dispatch or stores while failed ones are returned to rebuilders for analysis and rework.

The following paragraphs describe the remanufacturing operations at Company G's UK headquarters.

6.3 Operations G1, G3 and G4 (The main transmissions sub-assembly)

remanufacturing operations

Operations G1, G3 and G4 remanufacture known ranges of transmission type, on a contractual basis and for unique customers. Because they receive large quantities of similar transmissions they can use line production. Their remanufacturing operations are similar and are illustrated in fig 6.1, and described in the following paragraphs.

Fig 6.1: G1, G3 and G4 transmission sub-assembly remanufacturing operations.

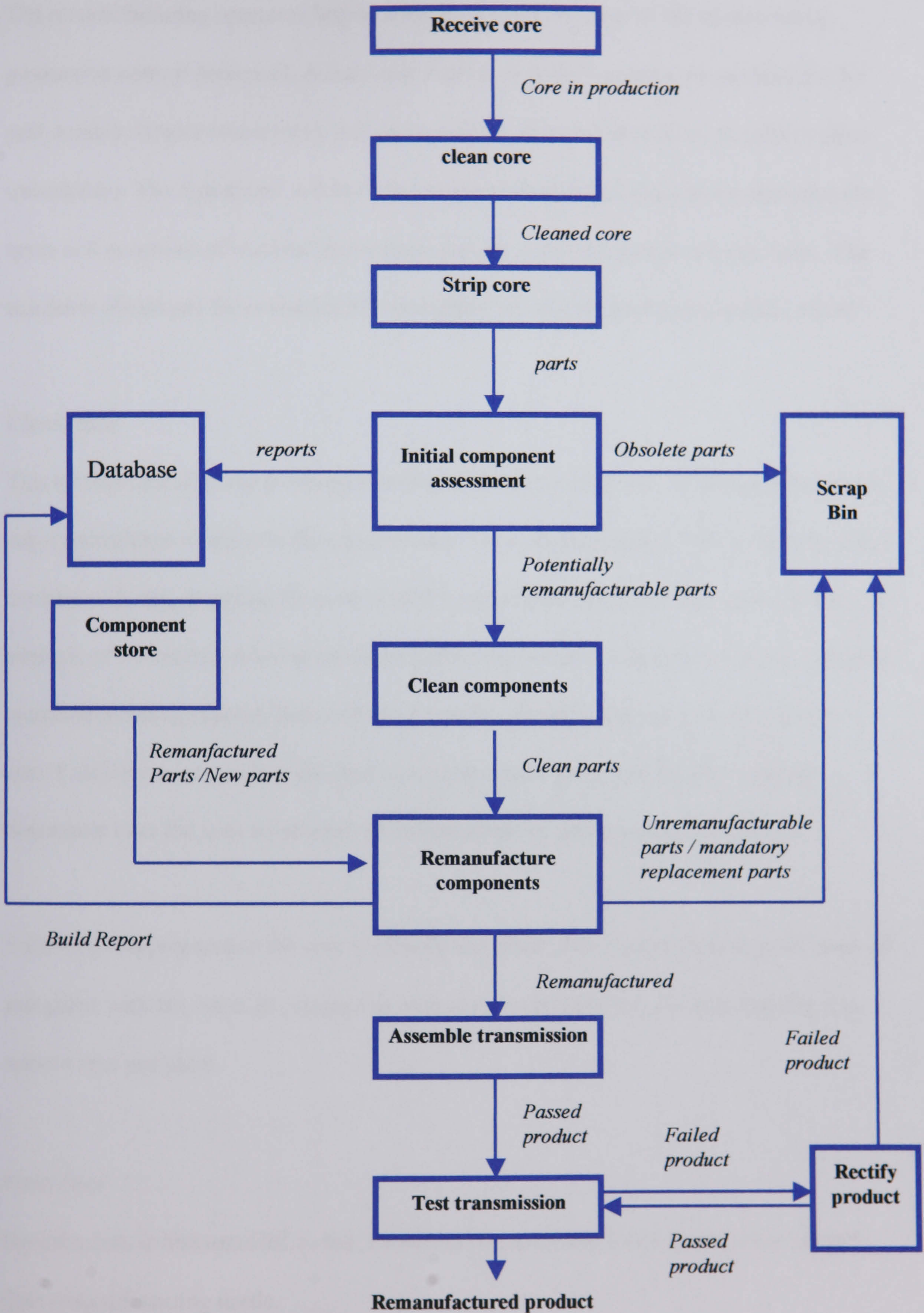

Receive core

The remanufacturing operation begins with the delivery of cores to the operations by production control personnel. A teardown sheet is attached to each core to identify it by part number, (transmission type), and serial number, (internal identification code to allow traceability). The operations' workers also receive schedules of requirement that state the types and quantities of required transmissions along with their receipt and due dates. The teardown sheets and the schedules of requirement are also issued by production control.

Clean core

This activity describes the thorough cleaning of the core's externals. It begins with a three-stage preparation to improve the effectiveness of the cleaning agents. This initial procedure consists of firstly, emptying the core of oil for operational and health and safety reasons. An example of operational reasons would be preventing wet shot while that of health and safety would be avoiding slippery factory floor. Secondly, plugging the box (covering all the core's orifices) to ensure that the steel shot blast cannot get in and, finally, spraying degreasant over the core to enhance the effectiveness of grease and grime removal.

Following this preparation the core is cleaned and dried. This involves washing off loose oil and grime with hot water jet; drying the core with compressed air, and shot blasting it to remove rust and paint.

Strip core

Here the core is disassembled so that its internal components can be examined to identify their remanufacturing needs.

Initial component assessment

Initial component assessment describes the visual inspection of components by operators. Obviously flawed and obsolete, (superseded) ones are discarded along with those such as rubber parts and steel plates that appear on the customer's mandatory replacement parts (MRP) list.

Clean components

This activity involves the degreasing of components with a paraffin type solvent; washing off the degreasant with a corrosion inhibiting cleaner and removing silicone sealant from covers. It also involves painting the transmission's covers. However, this last task is subcontracted because of space constraints and the capital expenditure that bringing the task in-house would necessitate.

Remanufacture components

Components are put into the subassembly area by trolley. Here they are grouped into six processing types, pick (small parts), evaluation (main parts such as cases and gears), solenoid, pump, input clutch and valve body.

The components are thoroughly inspected and tested. Dated and out of specification ones are built up to the required performance specification according to the instruction on build sheets. This is followed by operators' documentation to indicate, the tasks completed on the component, the operator's name, the types and quantities of new parts used in remanufacturing the subassembly and the description of and results of any tests carried out. This evidence stays with the core until it leaves the remanufacturing area and are subsequently passed to production control.

Unlike other subassemblies, the valve body is both stripped and remanufactured inside the subassembly build area. This is because the valve body consists of small parts that have, in the past, tended to “disappear” or become damaged during the normal washing in the teardown area. Inspected components are collected and transferred by hand (or by rollers in the case of evaluation subassemblies) to their holding areas.

Parts that are ready for delivery to assembly are packaged to facilitate their ease of identification. Their packaging may be colour-coded and item-specific containers may also be used. For example the 24 and 22 spline (teeth) clutches are virtually identical but prudent packaging is used to ensure that they are impossible to confuse. A unique colour has been assigned to the documentation that accompanies each of these clutch types and they also have specific holding containers. Even if a mix up were to occur in their documentation, they are still easily identified because the retaining slots built into their holding containers are not interchangeable.

Assemble transmission

This activity describes the re-assembly of transmissions with an assortment of new and remanufactured components according to build sheet information.

When each task is finished, documentation is completed to indicate this along with the name of the operator concerned and the description of and conclusions of any tests performed.

Following this, the assembled transmissions are placed at the completed transmissions holding areas until they are transferred, normally in batches, to the test rig.

Test transmission

Here transmissions are coupled with the appropriate converters and evaluated against the customer's requirements. Tests carried out include:

- Functional analysis to ascertain that the transmission is operational to the specified requirement. This typically occurs through simulation of the transmission's working conditions inside a vehicle. It may be performed by bolting the transmission onto an engine to ascertain that correct gear ratios can be obtained.
- Integrity examinations to assess the quality of materials and workmanship. Such assessment includes leakage testing by immersion in water.

If the transmission passes final appraisal then it is sent to dispatch where all the documentation attached to it is transferred to production control so that any components issued from stock for its remanufacturing can be deleted from the company's inventory system. Failure at the test rig results in the transmission being returned for analysis and rectification in the rework area.

6.4 Operation G2's transmissions remanufacturing operation

Operation G2 remanufactures automatic and manual transmissions for an assortment of customers. Because this operation remanufactures a wide variety of transmissions in very small batches it operates very much like a job shop.

In operation G2, only two or three employees are involved in the remanufacturing of individual transmissions. When two employees are involved, one operator has total responsibility for tear down and the other for building. In the case of three employees, one of the employees strips and remanufactures the valve body for the remaining two who must undertake all the other remanufacturing tasks required for that transmission including its

re- assembly.

G2's remanufacturing operation is very similar to that of G1, G3 and G4. The main differences are that G2 operates via jobbing process as opposed to line process. Also, because G2 costs each job separately on its own merit and charges the customer accordingly, its remanufacturing operation has a quoting activity. G1, G3 and G4, on the other hand have contracts that stipulate a pre-agreed job cost and therefore the quoting activity is omitted in their remanufacturing operational charts.

G2's remanufacturing floor area is divided into three areas, tear down, valve body and re-build. Operation G2's remanufacturing operation is illustrated in Figure 6.2. The mechanism used to schedule shop floor work in operation G2 and the tasks undertaken in the tear down, valve body and re-build shop floor areas are explained in the following paragraphs.

Scheduling

The shop floor scheduling mechanism is operated using two main items, builders metallic name tags and schedule aid boards. There are two schedule aid boards, the time board that indicates the time by which stripped cores must be available for individual builders, and the unit-type board that shows the transmission type required.

Both schedule-aid-boards are located the front of the teardown area. The time board has the hours of the working day listed on it in chronological order and each numeral has a metallic peg protruding from it. The unit-type board however, is blank.

Figure 6.2: G2's remanufacturing operation chart

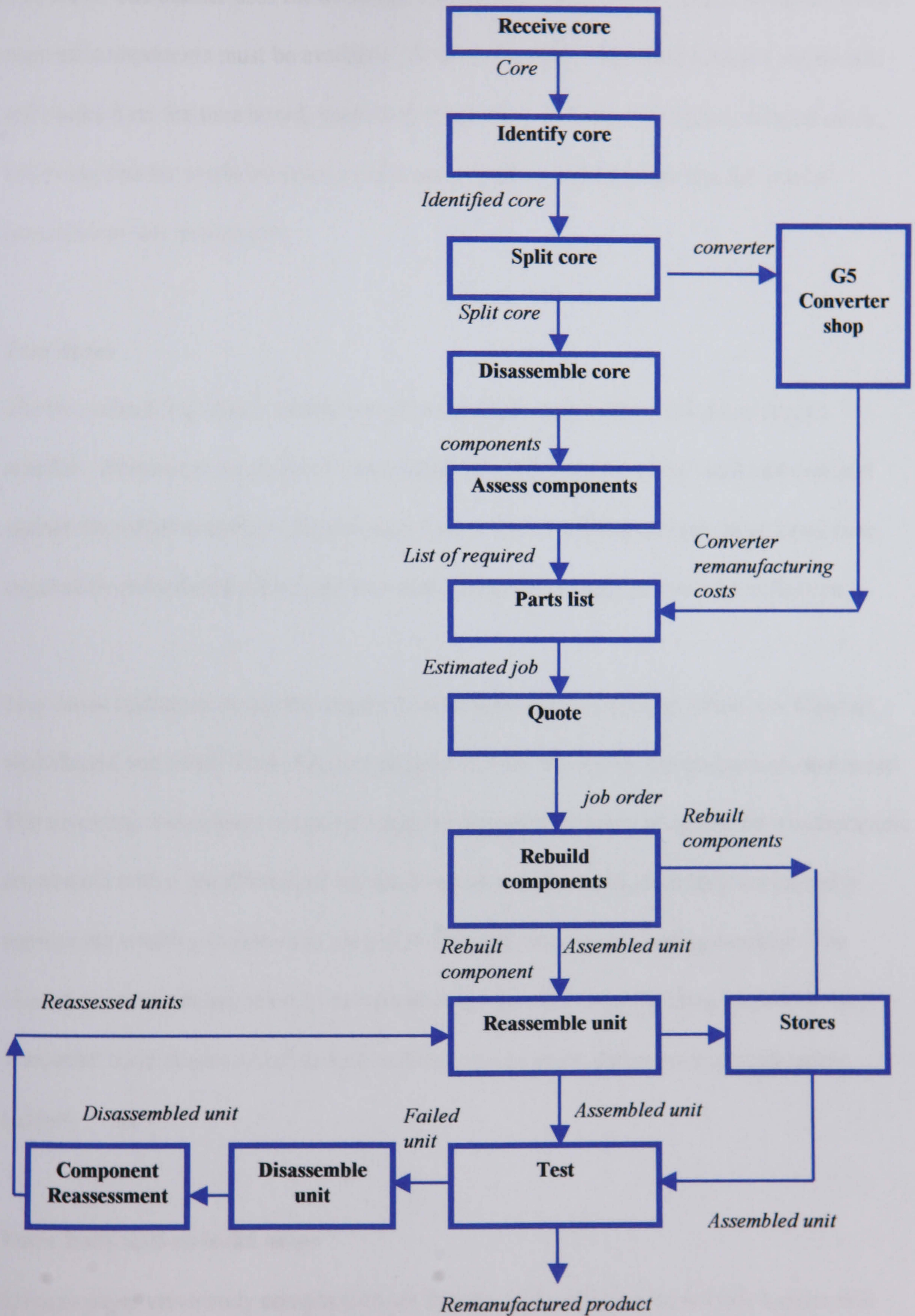

Each morning the departmental supervisor tells each builder the type of transmission that he is to build. The builder uses the average build time for that transmission to compute when required components must be available. He takes his name-tag to the schedule aid boards and hooks it on the time board, against the hours that he wishes to collect stripped cores. Following this he writes his name on the unit-type board and against this the type of transmission that he requires.

Tear down

The two scheduling boards enable tear down workers to process work according to schedule. Name-tags are picked in chronological order from the time board and matched against the names written on the unit-type board. This identifies the type of stripped core required by individual builders and also when these cores must be ready for collection.

Tear down operators obtain the required cores from the holding area. These are Cleaned, shot blasted and dried. Then they are stripped and any obviously flawed parts are discarded. The surviving components are put through an extensive cleaning program. First components are cleaned with a paraffin-based solvent to remove surface dirt, next they are placed in appropriate washing baskets and are put through an automated cleaning machine. The cleaned components are dried by compressed air, placed in large holding trays with their completed build sheet and left in their holding area to await collection by subassembly builders.

Valve body and re-build areas

Because many valve body components are delicate and small, the valve body builder will both strip and build this subassembly in the valve body build area. Machine build operators complete their tasks then obtain the completed valve body from valve body builders to

re-assemble the transmission. Re-assembled transmissions are placed in the completed transmissions holding bay. When an appropriate number (normally eight) of similar transmissions are available, test rig operators collect these for assessment at the test rig. Passed transmissions are dispatched while failed ones are returned to the builders for analysis and rectification.

6.5 Operation G5

Torque converter remanufacturers work in operation G5 and are responsible for the remanufacturing of all torque converters entering company G's headquarters. This includes torque converters taken from transmissions from operations G1, G2, G3 and G4 as well as those delivered unannounced or otherwise by the general public.

When transmissions arrive at the factory their torque converters are removed and labelled to indicate their type but not the vehicle or transmission that they came from. Labelled converters are stacked according to their type at the back of the received cores area. Company G's major customer's converters have specific service requirement and are therefore isolated from that of all the other clients whether contract or otherwise.

Operation G5 can remanufacture approximately 350 converters a week. Dirty and completed converters are stored in different areas of operation G5. Dirty converters are placed near the transmission splitting area while completed ones are stored near the test rigs. Both categories of converters are managed via a kanban system and specific converters have particular holding quantities. There is a chaser who alerts operators if converters are approaching minimum quantity levels. At any period the sum total of converters in the completed converter holding area is equal to that in the dirty converter holding area. Likewise the numbers of particular converter types in the two sectors.

G5 also has a monthly order that is used for scheduling contract work. The monthly order lists the types and quantities of torque converters that must be remanufactured each month. This figure is transformed into weekly requirements. Once these known obligations are achieved any excess time is allocated to non-contract work. Generally, operation G5 is unaware of any short term changes in the converter needs of company G's headquarters as a whole and of individual operations at the headquarters. However, it is able to satisfy company production needs through the chaser. Each operation G5 employee self inspects his work and also completes documentation detailing the quantity of tasks he completes each day. The process used to remanufacture torque converters at operation G5 is shown in Figure 6.3 on page 156, and can be described as follows:

Obtain work

Obtain work includes the "marking" and draining of the converter. The converter is taken from its holding area and is marked on two sides of its diameter to facilitate ease of re-assembly (i.e. the mating of the impeller and the back cover once all internal and external rectification are complete). The converter is drilled and left hole down on a drainage trough until it is empty of oil. The drainage trough is attached to a pipe that pumps the oil away at regular intervals.

Splitting converter and initially clean components

This describes the removal of the empty converter's seam weld with a lathe to separate the impeller from the back cover, and reveal the converter's internal components (the stator, turbine and lockup clutch). At this stage obviously poor and mandatory replacement components are discarded. The surviving components are washed in a solution of water and general degreasing powder.

Sort components, Wash / Blast, rebuild internal parts, Balance internal parts

The various components of the converter have specific requirements and following their drying with compressed air, they are divided into three groups, impeller, internal components and back cover. They will remain in these groups through intensive testing and cleaning and in fact until they are reunited for re-assembly at converter build. This stage also involves attaching a converter record card to the back cover to identify the type of converter it belongs to. The operators sign and mark off tasks on the record card as the subassembly progresses through the remanufacturing operation.

- **The impeller**

The impeller is sent straight to intensive wash and shot blast. Once dried it is sent to the impeller build area for light machining at the most, then from there to converter build.

- **Back cover**

The back cover requires greater attention than the impeller. For example, the back spigot will be checked with a Go-No-Go gauge. If the spigot passes freely through the gauge then it must be built up before use or else discarded. Other tasks performed on the back cover include the machining off of the clutch lining. Once all required back cover operations have been completed the component is sent for intensive wash and shot blast. Once dried the back cover is sent to the bonding shop where it receives a new clutch lining. This component is now ready to join the impeller in the converter build section.

- **The internal components**

These require the most intensive treatment. After turbines and pistons have been assessed and rebuilt with the assistance of build sheets and computer instructions they are balanced

to ensure concentricity in operation. This may involve welding metal weights to underweight components. Following this the internal components also are sent to converter build.

Converter build

Converter build is the assembly point where passed components are reunited with appropriate parts (not necessarily the parts they came with). Once the converter is reassembled, the tasks carried out on the various components are indicated on the converter record card. This involves transferring the work record documentation on the various components unto the converter record card.

Weld/leak test

Following assembly the cover and impeller are again welded together and leak tested by dunking (immersion in water and degreasing agent).

Foot grind

This is simply the smoothing of the weld with a grinder.

Converter balance test

Now that the converter is complete it is balance tested. This may involve welding metal to the converter to ensure concentricity. At this stage the converter is filled with oil and the pump drive is covered with a plastic cap to prevent contamination of the oil. Following this the converter is left in the holding bay to await collection by inspection staff.

Figure 6.3: G5's torque converter remanufacturing operation

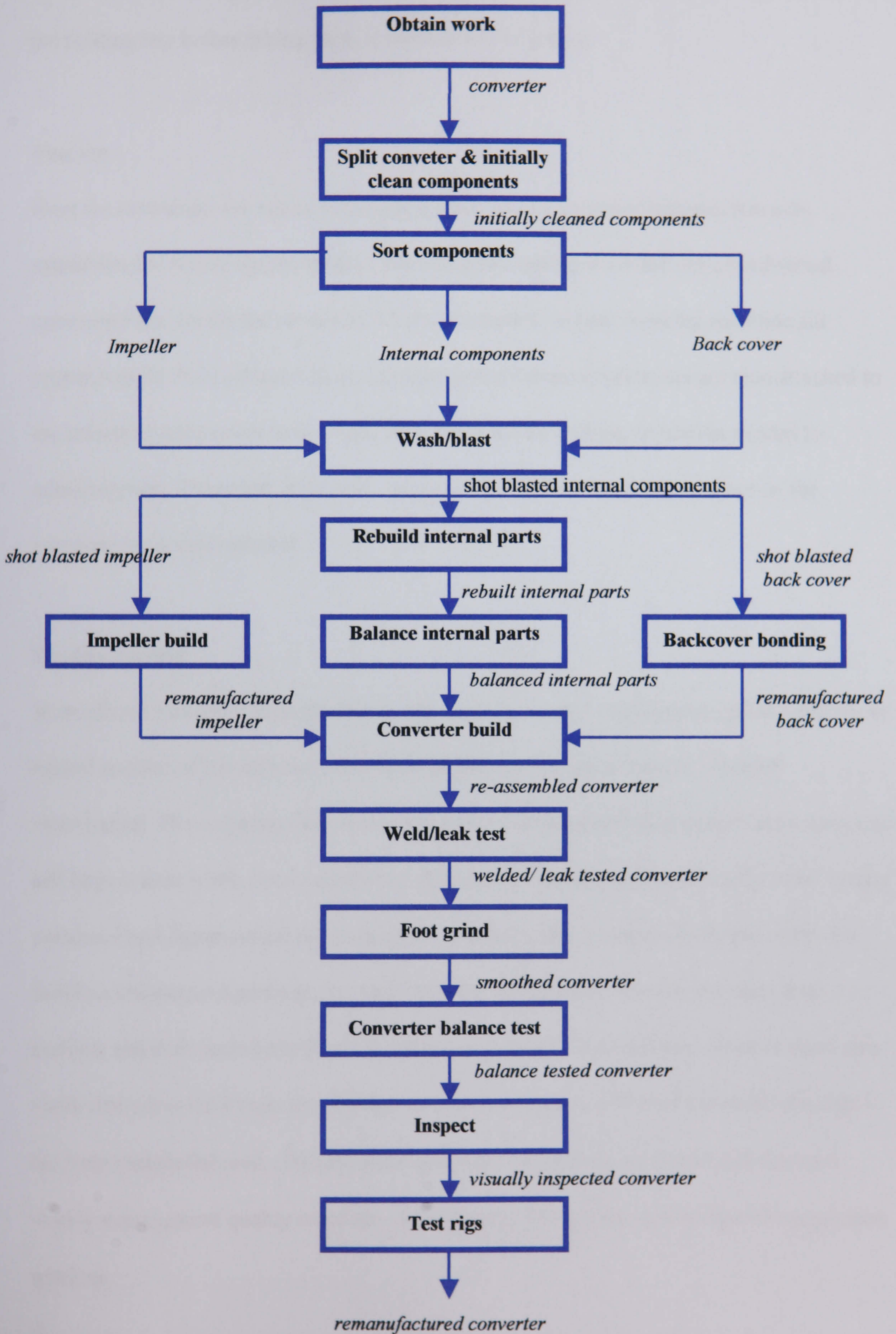

Inspect converter

Inspection staff are responsible for testing each unit. They visually inspect the converters in the holding bay before taking them in batches to the test rig.

Test rig

Here the converters are united with appropriate newly completed transmission sub-assemblies for whole system testing. Whole system testing is carried out on individual converters and entails the simulation of the converters' normal working condition for approximately thirty minutes. Test rig examination computer printouts are then attached to the converter and remain with it until they are removed at dispatch and forwarded to administration. These test documents serve as work certification and are kept by the company for several months.

Quality control

In an effort to maintain high product quality, quality control employees regularly remove an agreed number of transmissions that have passed test rig assessment for detailed examination. The company does not support spot-checking and all operators are required to self inspect their work. New recruits can take part in the building process only when quality personnel and departmental supervisors are satisfied with the standard of their work. To facilitate training and performance measurement, all operators identify the tasks they perform and their record sheets are collected each week. Transmissions cleaners must also verify that cores have been shot blasted and this evidence is collected for each core once it has been remanufactured. Departmental meetings are held once a month and there are weekly management quality meetings. All company G's operations also operate suggestion schemes.

Shop Floor Inventory control

All Company G's operations try as far as possible to place components in close proximity to their point of use. Components are divided into three groups according to their cost and requirement frequency. Two of the component groups, inexpensive components (components costing less than £0.14) and medium expense but frequently required components are stored in the build area close to the operators. However, the two groups of components have dissimilar control mechanisms. The latter set are managed by a two bin system while the former are in single containers that are replenished regularly with three months supply of components. The third group of components consists of very expensive and medium value but scarcely required components. To obtain these, operators complete stores requisition sheets that must be counter signed by the operations supervisor before stores can issue the requested component.

Contracts, product costing and injection rate.

To negotiate a new contract, typically the customer is asked to provide several of his cores. These are stripped to determine on average the quantities and types of components that must be replaced during remanufacturing (the injection rate). The injection rate is combined with other remanufacturing costs to ascertain contractual details such as job costs. Along with parts delivery lead-time the injection rate is also used to forecast reorder levels and quantities. Operators' documentation of quantities and types of components used during remanufacturing are used to assess and revise contracts.

Company G's overall management View

The view of company G's management is that the key to cost effective remanufacturing is the ability to reduce operating costs and lead-time while simultaneously maintaining high

product quality. This is summarised by their Chairman whose motto is *“what makes me money is what I don’t put in rather than what I put into my products”*

The author’s observations

During the research, investigations were undertaken to determine whether discrepancies and errors typically occur during the “assess component” sub-process. The following examples illustrate the level of inconsistency observed in company G.

Example 1

The researcher found that line managers were unable to identify the flaws on discarded components. Although the operator who had discarded those parts gave various reasons why the components were unfit for reuse, neighbouring operators were willing to use a large proportion of the rejected components.

Example 2

Following re-inspection of discarded components operators passed almost 30% of the components that they had previously failed. The organisation stated that this can occur because of three principal reasons. Firstly, new recruits are instructed by their more experienced peers who have themselves been trained through word of mouth and without the benefit of clear written instruction. Secondly, poor practices can be passed on to new recruits because their instructors have lost some of their knowledge over the years. Thirdly, experienced workers may have insufficient time to teach or may be unwilling to lose their positions as the company experts.

Example 3

The chairman of organisation G inspected a selection of expensive components from the disposal bin. He passed many of these because he recognised that the faults in those components could not affect their functioning inside the product. He stated that such situations arise because operators are frequently under pressure to work accurately and rapidly. In the absence of clear documented assessment criteria and procedures they may often discard reclaimed components and resort to new alternatives rather than risk outputting poor quality products or falling behind their quotas.

6.6 Company H

Company H is company G's sister company and remanufactures large industrial transmissions very close to company G's UK headquarters. Company H operates independently of company G but its converter remanufacturing tasks are subcontracted to operation G5. Company H does not have contracts with its customers who may arrive unannounced with an assortment of cores. Because the company cannot control the variety and quantity of orders it receives, it is prone to feast and famine periods. Inventory control is difficult and generally managed on the basis of "guestimates". For example, large quantities of old cores are bought and held in stock "just in case".

Because the quality of a used transmission is governed by its life history rather than by its make or age, company H cannot judge the condition of received cores prior to their disassembly. Every core is appraised and costed on its own merit. Typically, the transmission is split (separated) from its converter subassembly and the converter is sent to operation G5 who assess its remanufacturing costs. At the same time, company H disassembles the transmission and evaluates its components to determine an approximate remanufacturing cost. The total job cost is taken as the costs involved in remanufacturing

both the transmission and its converter sub-assembly and this cost is sent to the customer as the quote for the job.

Although customers may take more than three months to respond to a quote, company H will not begin remanufacturing a transmission without written certification. If the customer declines the quote he receives back his core disassembled and without fault analysis details, however, he is not charged for the job estimation costs. Company H keeps a stock of remanufactured transmissions and prefers customers to select from these because the customer's core can then be remanufactured for stock at the company's leisure.

Company H makes little use of automation and IT and cores are processed on a jobbing basis. Operators are responsible for the quality of their output and self inspect their work. Also, each employee is expected to single handedly complete all the tasks required to remanufacture a transmission. The activities involved in remanufacturing transmissions at company H are illustrated in figure 6.5, and are described in the following paragraphs.

Receive core

When a core arrives at the factory it is identified and two tickets are attached to it. These are:

- The job card that identifies the type of the transmission, the customer's name, receipt date and the accessories that it came with.
- The route card. This ticket also identifies the core by its type and customer and stays with the transmission until it leaves the factory.

Drain core

This is simply the removal of any oil inside the core. All cores must be empty prior to processing because of operational and health and safety reasons, for example, prevention of wet shot and slippery factory floor. Because customers often neglect to empty their machines company H must carry out this task.

Split core

The transmission is separated from its converter subassembly which is subsequently subcontracted to operation G5 for assessment of its remanufacturing costs (as well as its actual remanufacturing if company H and the customer agree an acceptable job cost).

Assess transmission's remanufacturing needs

The transmission is completely disassembled and all its components are evaluated to determine extent of wear and remanufacturing solutions. The operator produces a parts list specifying the type and quantity of required new parts. This list will contain parts that cannot be brought up to specification or that are replaced in any case, (for example gaskets).

Estimate cost

The parts list is given to administration along with the details of converter remanufacturing costs. This information is used to determine an appropriate job quote.

Quote

Company H sends the customer details of the transmission's total remanufacturing requirements and the job quote. If the customer declines the quote, company H returns the core back in its disassembled state.

Fig 6.4: Company H's industrial transmissions remanufacturing operation

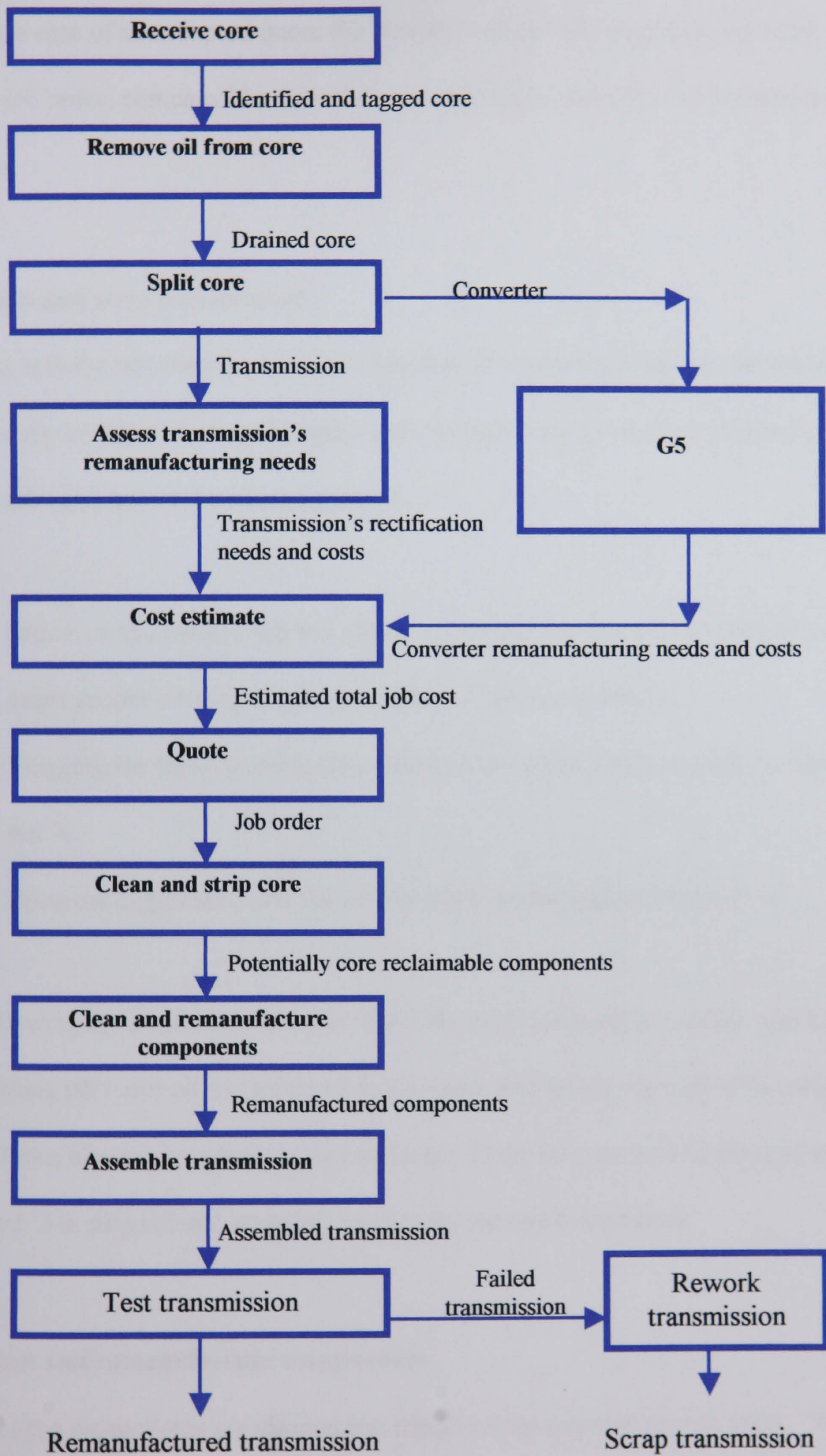

This is because core disassembly and evaluation is expensive and company H is unwilling to spend further resource on the re-assembly of a core when it has nothing to gain by doing so. In the case of an accepted quote the customer sends the company a job order. On receipt of the job order, company H begins the remanufacturing operation according to the following plan.

Clean and strip transmission

This activity describes the thorough cleaning of the externals of the transmissions by steam cleaning and shot blasting. It begins with the following three-stage preparation to improve the effectiveness of the cleansing agents.

1. Minor re-assembly of the box (core), to protect the internals of the core and also to assist proper cleaning of the case (body of the compressor).
2. Plugging the box (covering the orifices of the core), to ensure that the steel shot cannot get in.
3. Spraying degreasant over the core to assist grease and grime removal.

Following the preparation the core is put through the cleaning process which involves washing off loose oil and grime with hot water jets; drying the core with compressed air, and shot blasting it to remove rust and paint. Once the externals of the core are cleaned and dried, it is stripped and attention turns to its internal components.

Clean and remanufacture components

Here the components are cleaned and rebuilt to the required specification. The cleaning of the components involves their degreasing with a paraffin type solvent, the washing off of the degreasant with corrosion inhibiting cleaner and the removal of silicone sealant from covers.

Following their cleaning the components are thoroughly inspected and tested. Dated and damaged parts are built up to at least original OEM performance specification from the customer's perspective while components that cannot be brought to the required specification are replaced with new or remanufactured equivalents. During this activity the operators also paint the covers either manually or with spray guns.

Assemble transmission

This involves the re-assembly of the transmission using an assortment of new and old parts according to build sheet instructions. This is followed by operators' documentation to indicate the tasks performed on the transmission, the name of the operator who remanufactured the transmission, the types and quantities of new parts used as well as the description of and results of any tests undertaken on the components and assembled transmission. Once all these tasks are completed the operator delivers the transmission to the test rig for functional testing.

Test

Here the assembled transmission undergoes rigorous examination against the customer's requirements. If the transmission passes final evaluation then it is packaged ready for the customer or else is put into stores to await purchase. Failure results in its return to the operator for reassessment and rectification.

The two tests carried out are, as for company G:

1. Functional analysis to ascertain that the transmission is operating to the required specification. Typically, this involves simulating the transmission's working environment inside a vehicle. For example, the unit would be bolted unto an engine to test whether the correct gear ratios can be obtained.

2. Integrity examination to assess the quality of the workmanship and the materials used.

Examples of integrity examination include leakage test by dunking, (immersion in liquid).

Test results are again noted and attached to the list of documentation. This evidence stays with the transmission until it leaves the remanufacturing area and is subsequently given to production control.

Inventory control

Inventory control is purely by guesswork because company H is uncertain of the types and quantity of transmissions that it will receive. Small quantities of frequently used components are held in stock “just in case”. Company H actively seeks and purchases old transmissions because it is difficult to obtain spare parts for them. These old transmission models are kept in stores and are cannibalised (used as a source of components) to fulfil orders when the need arises.

Quality control

Each operator self inspects his own work and transmissions cannot be dispatched without thorough evaluation at the test rig. Although quality is paramount to company H, there appeared to be no methods of monitoring warranty.

The information given under critical issues, key problems and overall management view in the paragraphs following are direct reports of company G and company H’s representatives and do not represent the author’s views of either or both companies or remanufacturing companies in general.

Critical issues

The managements of companies G and H stated that in the remanufacturing market the main order qualifiers are quality and reliability because high profile customers would not purchase inferior goods no matter how inexpensive. This is because such customers would not wish to compromise their reputations by allowing the incompetence of others to hinder the effectiveness of their own production processes.

They also stated that the remanufacturing order winners are cost and lead time. They stated that low cost is attractive to their customers because typically they are other business concerns who hope to lower their production costs by purchasing low cost plant and machinery. They also stated that short lead time and reliability is important to their customers because every extra minute an industrial transmission spends at the remanufacturer's factory is often an extra minute less in the running of expensive machinery.

Key problems

According to companies G and H the major remanufacturing problems result from the following:

- **Difficulty in evaluating the appropriateness of reclaimed parts.**

The main reasons given by the companies for this situation is that in remanufacturing few standards and methodologies are available to assist consistency and accuracy of component assessment. Because of this operators may give vastly incompatible and inconsistent opinions regarding the suitability for reuse of particular components. This problem reduces the effectiveness and efficiency of production and therefore has profound impact on the profitability of remanufacturing concerns.

- **Ignorance regarding long and short term requirements.**

The companies claim that because it is impossible to determine when customers' machines will fail precise inventory and labour requirements cannot be forecast. This problem is even greater for independent remanufacturer such as Company H because they have no contracts and therefore are unsure of the product types that they will receive.

- **Inability to predict customer requirements.**

Because the internal conditions of machines are determined by their service history and operating conditions the remanufacturer cannot determine the service requirements of received products prior to their disassembly and inspection.

Company H's management's observation

The main problem for the remanufacturer is how to reduce operating cost. In remanufacturing, as in all business, cost reduction is governed largely by the efficiency and effectiveness of organisational decision making. Remanufacturing decisions should be geared towards maximising the reclaiming of used components and this involves optimising the productivity of processes and people.

The author's observations

As in company G the author carried out experiments to assess the consistency of component testing. This involved asking the director of company H to inspect a selection of expensive components from the disposal bin. He passed many of these because he believed that they were fit for reuse. He stated that his employees are frequently under pressure to work accurately and rapidly but because there are few documented assessment criteria and procedures they often rely on their experience. He believed that as a result of this, when

they are faced with a component that they are not very familiar with they would prefer to err on the side of caution rather than risk producing a poor quality product.

6.7 Company F

Company F remanufactures compressors for the refrigeration industry. It was the second company to begin remanufacturing on a large scale in the UK and is recognised as the first compressor remanufacturer to open a network of locations in mainland Europe. Company F has 5 sites and 18 distributors in the UK. It has markets in the UK, Europe and Overseas and in 1996 held 32% of the UK compressor remanufacturing market. The company has approximately 35 employees at its UK headquarters and its strength includes its capability to complete a remanufacturing program within 24 hours. In more recent years it has merged with a larger international organisation that in 1996 had a total turnover of £120M.

During the case study, company F's key informants were the process and general managers as well as some supervisors.

Company F's remanufacturing operation

When a customer has problems with his compressor, the customer, subcontractors or company F's specialist site team removes it from his premises and bring it to company F.

Company F remanufactures the core (used compressor) according to the activities shown in Figure 6.5 and explained as follows.

Book in

When the core arrives at company F, it is given a unique code that is entered into the company database to enable efficient tracking of its progress. This procedure is referred to as "booking in" and indicates which loop, warranty, stock replacement, or urgent

remanufacturing route that the core will take. Using this information the computer raises a worksheet so that detailed records can be kept. The core is then assigned to a qualified fitter and is loaded onto his work station. If the core is a warranty return the customer is supplied with an alternative from stores.

When an alternative is not available, or the customer requests the return of his own compressor, company F will carry out urgent remanufacturing of the core.

Strip and report

The most significant aspect of the strip and report activity is a basic assessment to obtain an initial quantification of the core's problems and that is undertaken in the customer's presence. Details of tasks identified by this examination are recorded on the rectification requirement report. Strip and report includes draining oil from the compressor and then disassembling it. Once all parts are stripped from the compressor the windings are dropped out (removed), using a custom built induction heater.

Clean and check

The purpose of this activity is to help to ensure that the compressor is of the highest quality when it leaves the company. The first stage of this activity is a visual examination to discard components that are on a mandatory replacement list or that are obviously damaged beyond rebuilding. Such components must be replaced with remanufactured or new alternatives. This stage may also involve the placing of a purchase order to obtain required components and even subcontracting out of tasks. Other tasks undertaken at this stage include the cleaning of all potentially reclaimable components to assist their accurate testing and qualification. Clean and check also includes cleaning the compressor body to improve

the cosmetic appearance of the rebuilt compressor. Cleaning methods used by this activity range from basic manual cleaning to a sophisticated three-stage caustic process.

Fig 6.5: Company F's remanufacturing operation diagram

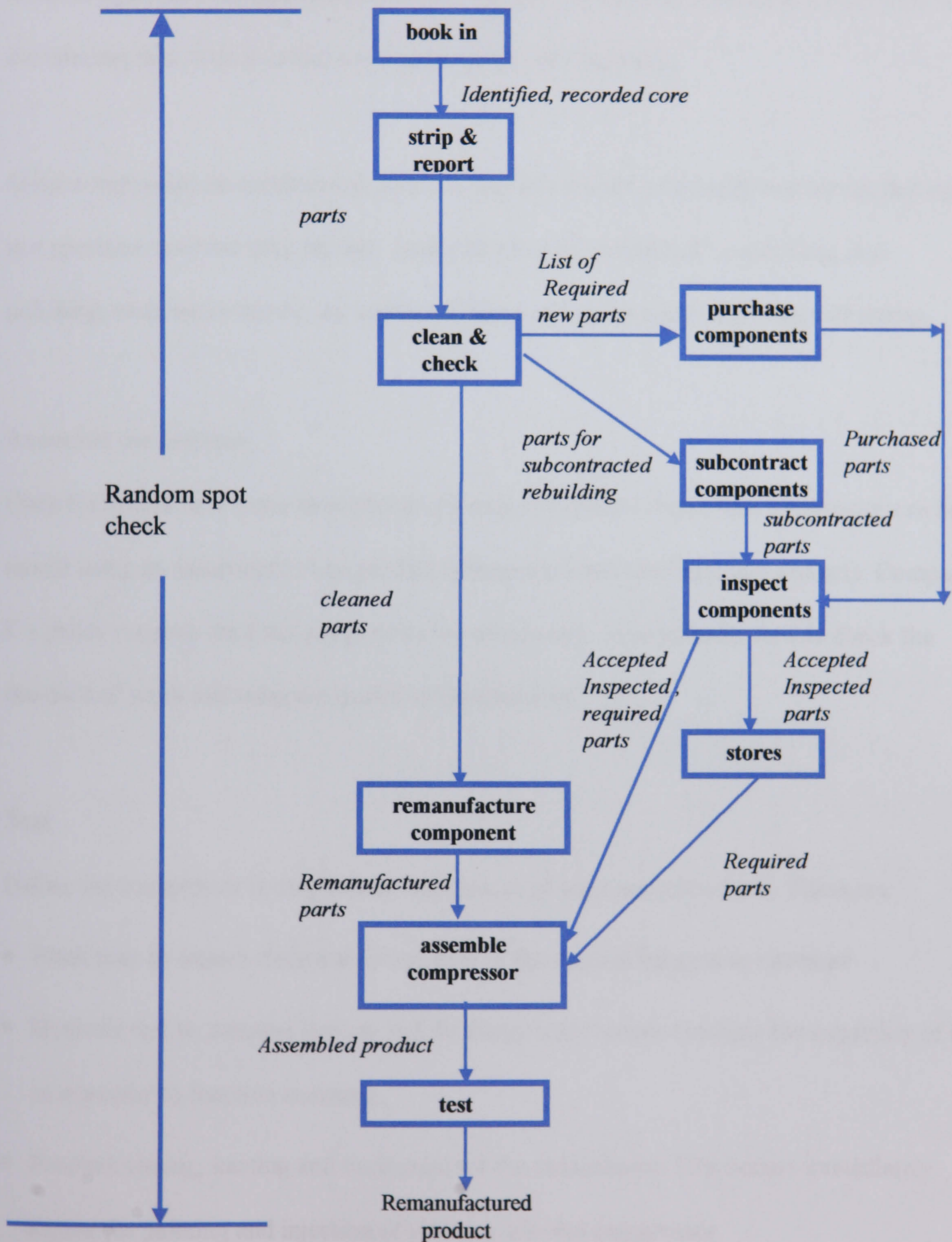

Remanufacture components

Component remanufacturing describes the treatments required to bring used components back to at least original OEM performance specification from the customer's perspective.

For example windings are thoroughly tested to assess their suitability for use and this involves rigorous examinations to ascertain that no electrical abnormalities are present. If the winding fails, then a tested pre-wound motor will replace it.

Some component remanufacturing tasks require specialised processing and are carried out in a specialist machine shop facility. Such tasks include crankshaft re-metalling and polishing, machine re-boring, as well as oil pump and valve plate rebuilding and testing.

Assemble compressor

Once the compressor parts have passed the required quality checks the compressor can be rebuilt using an assortment of requalified (remanufactured) and new components. Company F's policy requires the fitter assigned to the compressor to continually double check the standard of work including the quality of components.

Test

Before the compressor is despatched four groups of tests are carried out. These are:

- Flash tests to ensure electrical correctness of the remanufactured compressor.
- Dynamic test to measure suction and discharge and thereby ascertain the capability of the compressor to function correctly.
- Pressure testing, heating and vacuuming of the compressor. This occurs immediately before the painting and injection of nitrogen into the compressor.
- Visual inspection to check the cosmetic appearance of the rebuilt compressor.

In addition to the above quality examinations, workers self-inspect their work and also two full time quality inspectors carry out spot checks throughout the remanufacturing operation. If the compressor passes all the relevant tests it is despatched to the customer or else put into stock to await purchase.

The information given under critical issues, key problems and overall management view in the paragraphs following are direct reports of company F's representatives and do not represent the author's views of that company or remanufacturing companies in general.

Critical issues

Company F believes that people are the key to its success and that the critical issues for its industry are quality, service and delivery. It attempts to meet these requirements through the following strategies.

- **Quality**

The company has a rigorous quality control system and is ISO9002 accredited. Recently company F embarked on an exercise to strengthen its management team by bringing in highly skilled personnel such as quality and technical liaison officers. It has a training program to try and ensure that its workforce has the level and type of skills it requires. There is also a general consensus that workforce flexibility is desirable.

- **Service and delivery**

The company believes that service and delivery are customer driven. It attempts to gauge the product time cycle (remanufacturing lead-time) of its products by dividing compressors into three classes, large, medium and small. An estimate of the time required to remanufacture each product class is obtained by taking an average of monthly values.

Because it is impossible to reduce the number and complexity of tasks involved in remanufacturing, the company strives to limit cycle time through effectiveness and efficiency. The tactics that the company employs to meet this goal include sound factory layout and stocking of correct components. Additionally, the company offers a network of distributors through out the UK. This scheme reduces product price by limiting distance-related costs such as carriage and travelling expenses. Additionally, it enhances response time for obtaining goods and services. In the future the company expects to add the forecasting of component demand and the use of external sales teams to this list of improvement schemes.

Key problems

The company believes that the main problem for remanufacturers is the difficulty of effective decision making and proposes that this situation is caused mainly by the uncertainty of the remanufacturing environment. According to company F, problematic decision-making issues include make or buy decisions, component inspection decisions and choice of component stocking levels.

Overall management view

Company F's overall management view is that there are many complex issues involved in remanufacturing and that difficult trade-offs have to be made. The company believes that to be competitive and profitable it must excel in its performance on service, price and quality. It also believes that price is a function of market perception and the service offered. It accepts that product price is greatly influenced by the level of repeat business. This is because generally one-off orders have order winning costs such as telephone and cold calling expenses, contract negotiation costs and so forth.

The author's observations

During the discussion the interviewer was surprised to note that the company uses an unusual definition of remanufacturing and repairing. This definition considered the importance of product control and in fact gave it a chronological value (one year) and by inference a monetary value. The most surprising aspect of this definition was that it appeared to place repair above remanufacturing.

The author had classed company F as a remanufacturer because it rebuilds used products (in this case compressors) back to original OEM performance specification from the customers' perspective. However, during the interview, the interviewee stated that the company gives repaired compressors a guarantee of two years (double that of a new compressor), yet its remanufactured compressors are given a guarantee of one year (exactly that of a new compressor).

When questioned further the interviewee explained that company F's compressors are rebuilt to similar standards and therefore should all operate correctly for a minimum of two years. However, because the functioning of a compressor can be influenced by the quality of its installation, the company will give two-year guarantees only to remanufactured compressors that it personally installs.

He went on to explain that when products pass directly from the company to the customer they are referred to as repairs. Such rebuilds will carry a two-year guarantee because they will be commissioned (installed) by the company. Remanufactured products, on the other hand, are installed by middlemen (the subcontractors) and therefore are given the minimum one-year guarantee to protect the company. This is shown in figure 6.6 following.

Figure 6.6: Company F's repaired and remanufactured compressor system

Repaired compressor

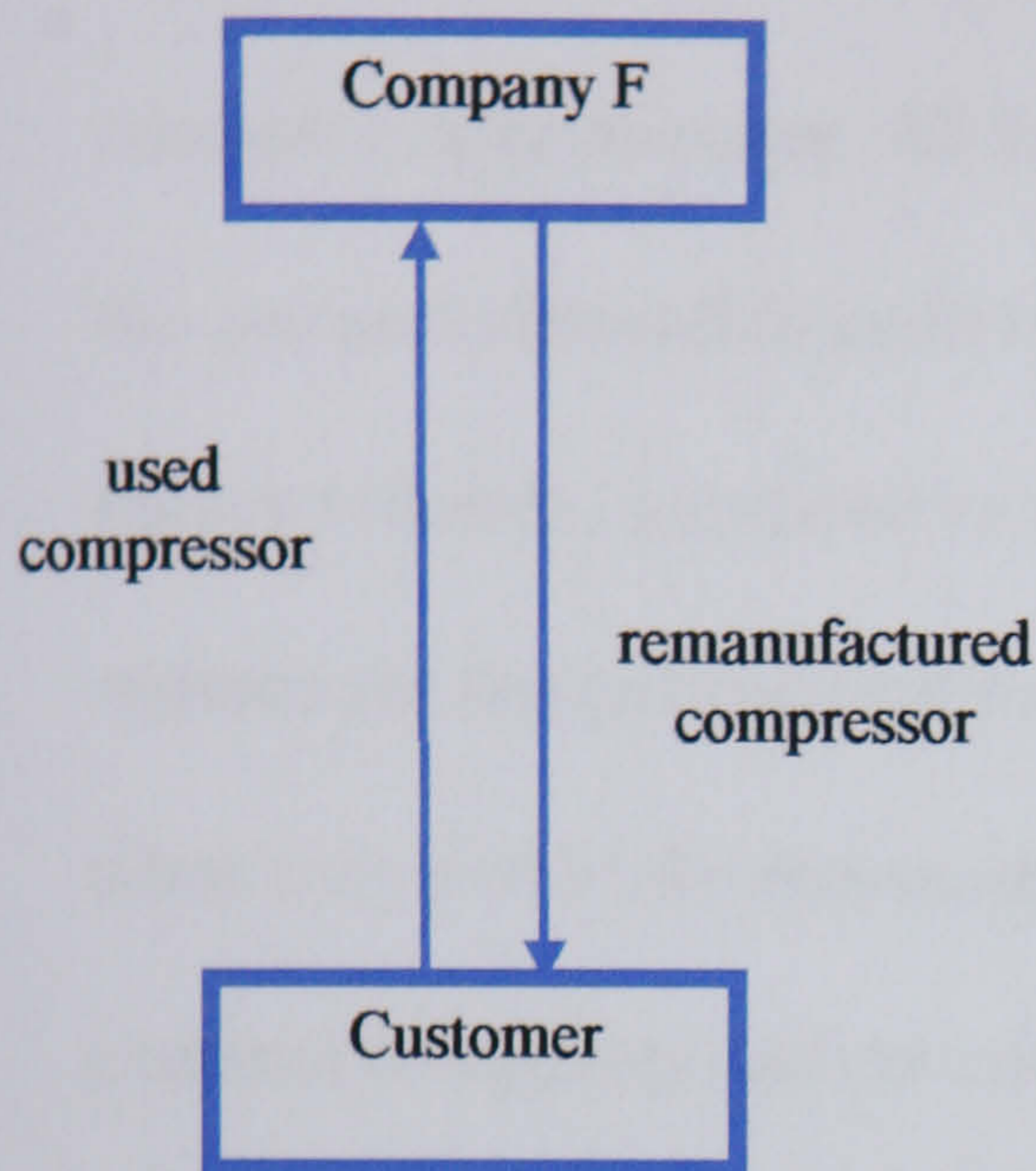

Remanufactured compressor

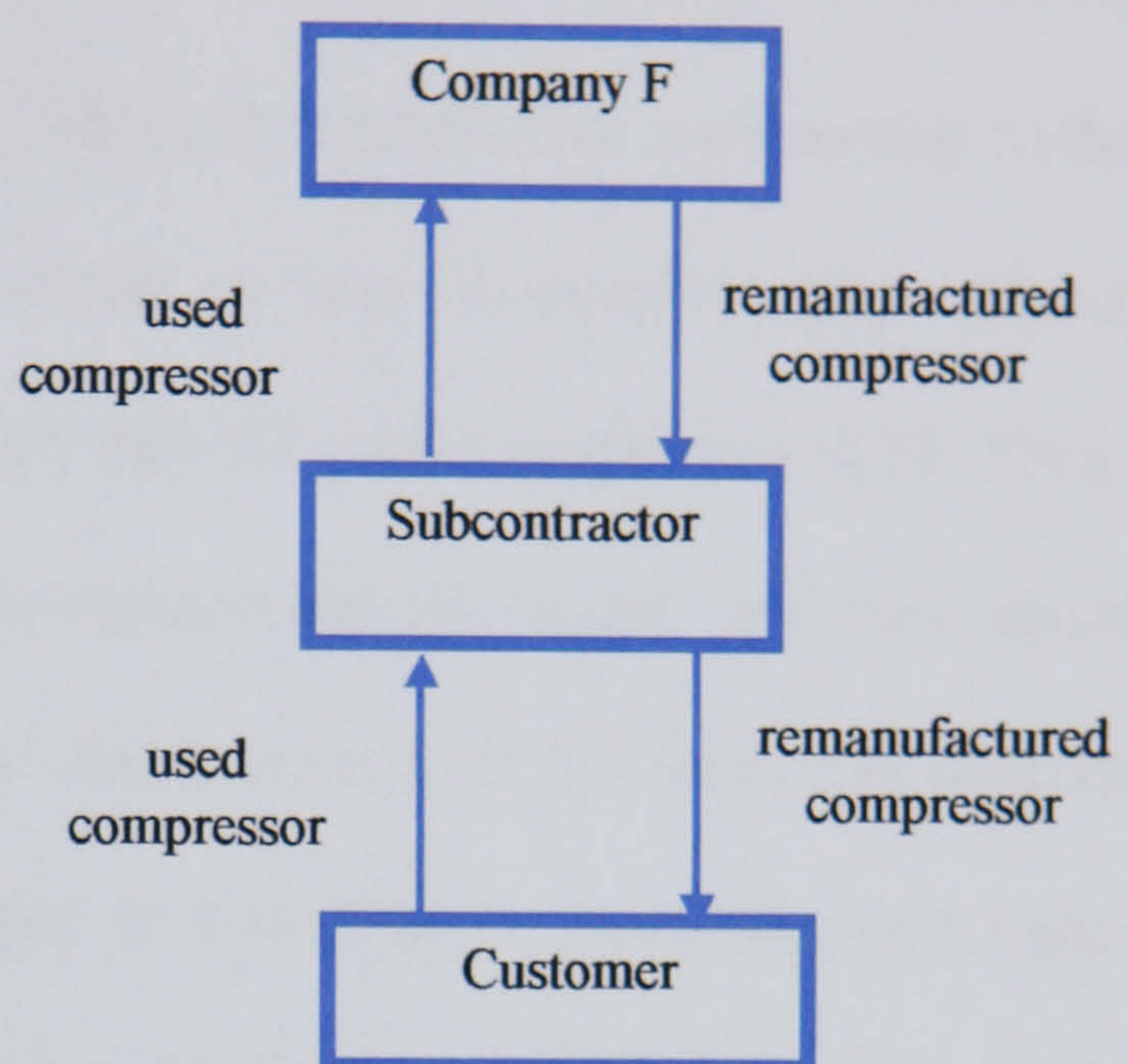

6.8 Analysis of the Phase 2 case study findings

- **The generic remanufacturing operation flow chart.**

All the Phase 2 remanufacturing operations had the same basic structure of receive core, inspect core, quote (if required), disassemble core, clean, remanufacture and replace components, assemble product and test product to original OEM performance standards.

This is similar to the operational structure identified in the Phase 1 cases.

- **Contract and independent remanufacturers**

In these Phase 2 case studies, operation G2 and company H represented the typical remanufacturer that operates without contracts. Both companies displayed the characteristics found in similar remanufacturers companies such as company D during the Phase 1 studies that were presented in chapter 4. For example, they made little use of IT and their remanufacturing operations included the “quote” activity. They often experienced

difficulties in obtaining parts from original equipment manufacturers and they operate via jobbing process because of the variety of product types that they service.

Operations G1, G3, G4 and G5 work mainly on contractual basis and were ideal examples contract remanufacturer. All four operations had characteristics that were similar to that of the contract remanufacturers from the Phase 1 case studies. For example, they enjoyed large output volumes, decreased levels of uncertainty and also made greater use of IT. They also operate the line process and their operational diagrams had no “quote” activities except when they undertake non-contract jobs. Their characteristics are similar to that observed in contract companies such as companies C, E and A of the Phase 1 cases. Figure 6.5 shows the generic models for contract and non-contract remanufacturers that has now been validated.

Figure 6.7: The operational charts of contract and non-contract remanufacturers

Contract remanufacturer

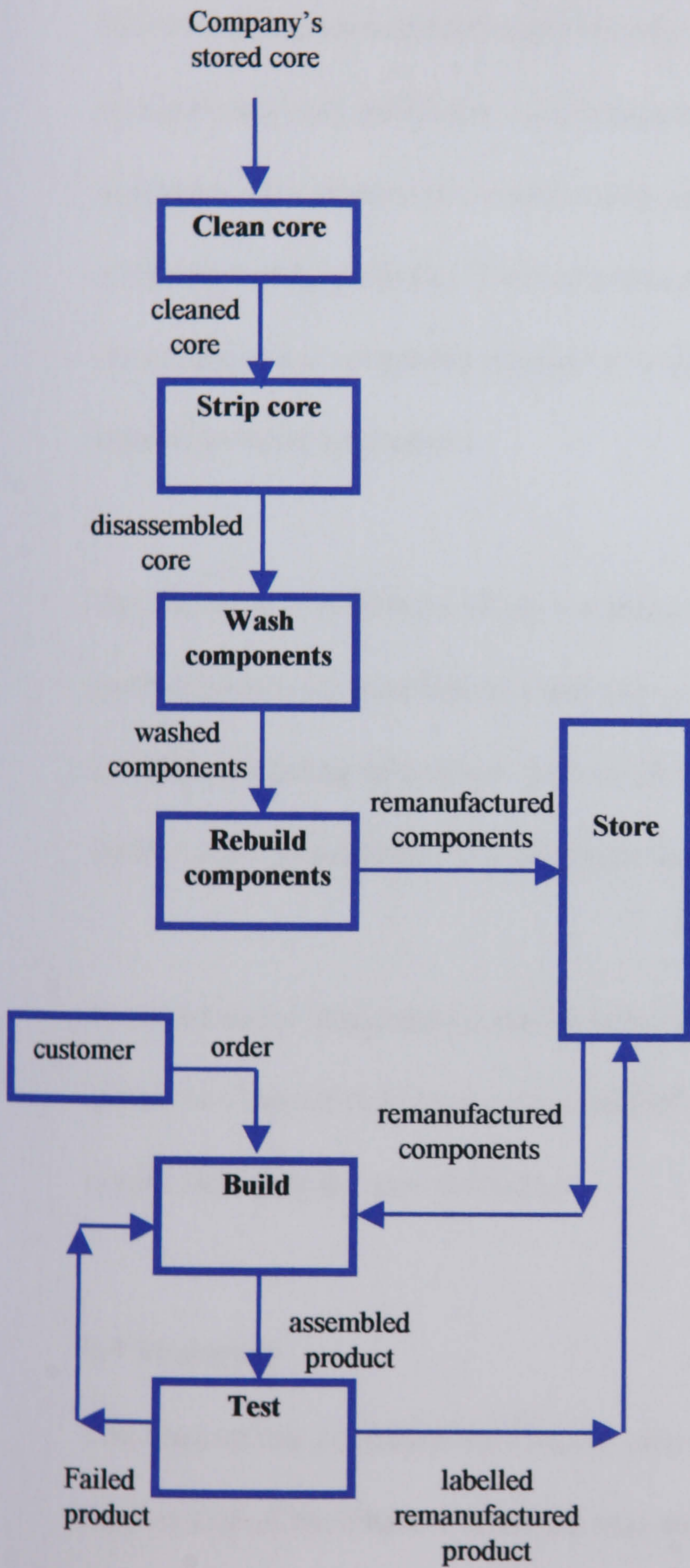

Non-contract remanufacturer

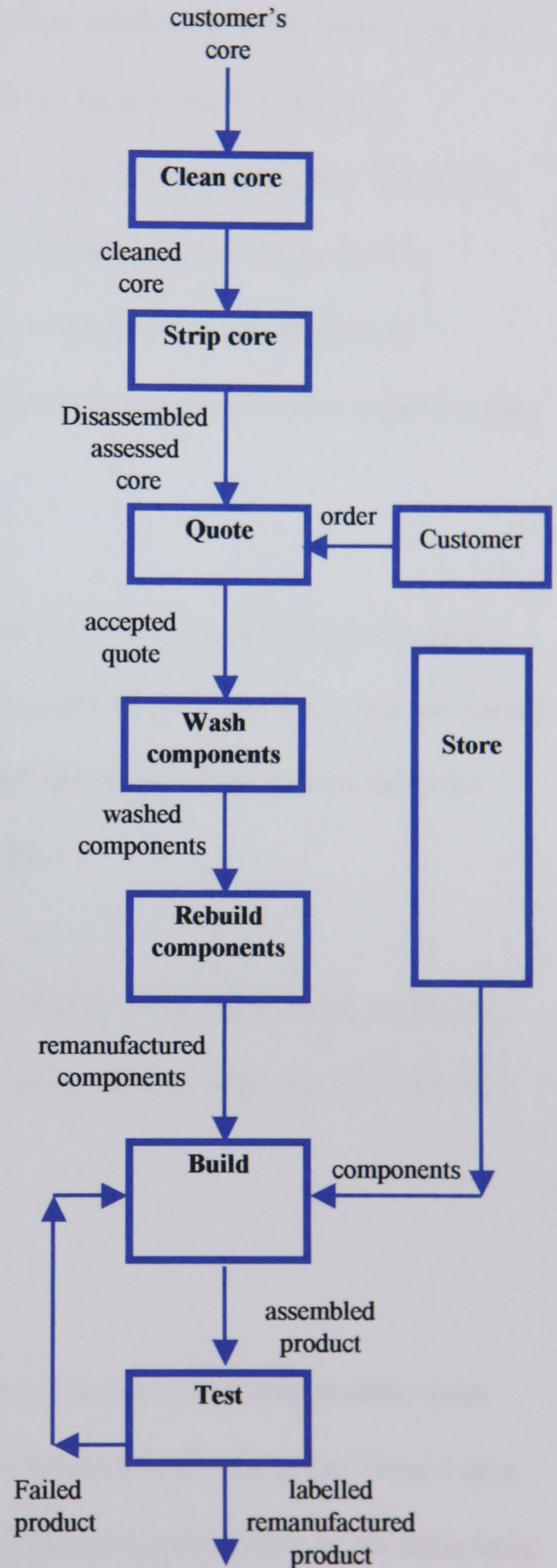

The major production control issues in remanufacturing

The major remanufacturing problems for all the Phase 2 case study operations result from difficulty in evaluating the suitability for reuse of reclaimed parts and ignorance regarding long and short term requirements. Investigations were carried out in the remanufacturing operations of organisation G and company H. The investigations illustrated the inconsistency and inefficiency of component assessment. For example, it was shown that operators often discarded reusable components and resorted to new alternatives in remanufacturing products. This can have an adverse impact on the profitability of remanufacturing companies because new components are significantly more expensive than remanufactured alternatives.

The chairman and director of the companies stated that this is because few standards and methodologies are available to assist the consistency and accuracy of component assessment in remanufacturing operations. As a result different operators may give vastly dissimilar opinions on the suitability of a particular component.

From the above discussion it can be seen that the findings of the phase 2 case studies are similar to those of the Phase 1 case studies. This can be taken as validation of the Phase 1 results including the new definition.

6.9 Summary

This chapter has presented the Phase 2 case studies. Because the findings of these cases support that of the Phase 1 studies it was accepted as sound validation of the Phase 1 case study findings. For example, all the Phase 2 remanufacturing operations had the same basic structure observed in the Phase 1 case study operations. Also, the organisations involved in the Phase 2 case studies had difficulties in assessing the suitability of components for reuse.

Finally the Phase 2 operations illustrated that non-contract and independent remanufacturers had some dissimilar characteristics. For example the quote activity is omitted in the operational charts of contract remanufacturers.

The following chapter compares remanufacturing to the alternative secondary market processes of repair and reconditioning.

Chapter 7: Comparison of remanufacturing, repair and reconditioning

7.1 Introduction

This chapter is concerned with the issue of inadequate understanding of remanufacturing. Chapter 2 presented a case for developing a robust and comprehensive definition of remanufacturing that would help to differentiate and distinguish it from alternative secondary market processes. Chapters 4, 5 and 6 provided descriptions of remanufacturing operations and remanufacturing practices. Those chapters identified that remanufacturing requires greater resource than repair and reconditioning and produces products that have greater warranty than the two alternative operations. These conclusions are in agreement with recent research that illustrate, for example, that remanufacturing obtains comparatively superior products to the repair and reconditioning operations (Guide and Srivastava 1999b).

The author would contend that problems such as the inadequacy of remanufacturing knowledge and the scarcity of remanufacturing tools and techniques, identified in chapter 2 are related to the shortcomings of remanufacturing definitions. Chapter 2 also explained that confusion in the definitions of secondary market operations has helped to hinder remanufacturing research and the dissemination of remanufacturing knowledge. This is because it is very difficult to carry out effective research on an operation that is not clearly defined or listed in dictionaries or trade directories. For example, there was not a great body of literature to refer to and there was little academic support because there was not a community of researchers to discuss the research with. The author has sought to resolve the problems caused by the ambiguity in remanufacturing definitions by developing a robust new definition of remanufacturing.

This chapter describes the shortcomings of popular current definitions of remanufacturing. It presents the author's new comprehensive definition that will allow remanufacturing to be distinguished from the alternative secondary market processes of repair and reconditioning for the first time. Also, it highlights the difference in quality standards between products obtained from the three operations by placing them on a hierarchy based on the performance of their products and the work content that they require.

7.2 Shortcomings of popular current definitions of remanufacturing.

The inconsistency in the definition of secondary market processes and the ambiguity of remanufacturing definitions can be illustrated by examining two of the most popular definitions of remanufacturing that are currently used by researchers.

7.2.1 The Amezcuita *et al.* (1996) definition of remanufacturing

Amezquita *et al.* (1996) describe remanufacturing as:

“The process of bringing a product to like-new condition through reusing, reconditioning, and replacing component parts”.

In the same paper they describe reconditioning as a process that is different from remanufacturing and, in fact, one that produces products that are inferior in quality to those produced by remanufacturing. However, since practitioners (see chapter 4) state that the quality of a product is governed by the quality of its individual components, a product that has within it reconditioned components can be described as remanufactured only if remanufacturing and reconditioning describe the same process.

If on the other hand, as proposed by Amezcuita *et al.* (1996), remanufacturing is indeed superior to reconditioning, then a product that has reconditioned components (i.e.

components that are below the quality standards of remanufacturing), must itself be below the standards of the remanufacturing process. Such a product can therefore not be described as remanufactured.

Because the definition above has not differentiated remanufacturing from reconditioning the author believes that Amezquita *et al.* (1996) have provided an ambiguous definition of remanufacturing.

7.2.2 Haynesworth's definition of remanufacturing

In 1987, Haynesworth and Lyons published one of the first definitions of "remanufacturing" when they described the concept as:

"The process of bringing a product to like-new condition through replacing and rebuilding component parts"

They go on to explain that:

"Products that have been remanufactured have quality that is equal to and sometimes superior to that of the original product".

The implication of this sentence is that remanufacturing involves upgrading the used product to or above the specification of the OEM's original model. The case studies undertaken during this research are described in chapters 4,5 and 6 and indicate that this bringing of remanufactured products to *at least OEM original specification* is one of the important factors that practitioners use to distinguish remanufacturing from repair and reconditioning. Because of this, the author believes that Haynesworth and Lyons (1987) have proposed one of the most precise definitions of the remanufacturing operation.

However, this definition does not provide a method for the purchaser to easily recognise that remanufactured products have higher quality than repaired and reconditioned alternatives, or that remanufactured products have similar quality to new alternatives.

Because of this the author believes that the definition proposed by Haynesworth and Lyons (1987) is also insufficient.

According to organisations such as the Department of Trade and Industry (DTI) and Federation of Automotive Transmission Engineers (FATE) the legal performance requirement for secondary market products, where such regulations exist, stipulates guidance about minimum quality levels only and producers are held to account on the warranty that they give their products. Also, the case studies that were discussed in chapters 4, 5 and 6 have shown that practitioners believe that a warranty serves as a guide to a product's quality. They say that they give their remanufactured products at least the same warranty as the OEM equivalent because it is a method of indicating that the quality of their product is similar to that of the OEM equivalent. In fact some remanufacturers such as company F give their product twice the warranty of the equivalent OEM alternative.

When interviewed about their opinions about the three types of operations all the practitioners believed that remanufacturing, repair and reconditioning are not synonymous because they involve dissimilar work content and produce products of dissimilar quality that are given different warranties. It can also be seen that practitioners believe that between the three operations, remanufacturing obtains the highest quality of products followed by reconditioning, while repair produces the least product quality. They also agreed that the three operations could be differentiated using two factors. These are:

1. The level of quality of the secondary market product when compared to that of an

equivalent new product.

2. The standard of the warranty of the secondary market product in comparison to that given to the equivalent new product.

7.3 The author's new definition of remanufacturing

The author's new comprehensive definition of remanufacturing augments that of Haynesworth and Lyons (1987) by introducing the practitioners' quality indicator of warranty as a product quality identifier. This development allows remanufacturing to be clearly differentiated from repair and reconditioning on the basis of the quality of its products relative to that of the equivalent OEM product.

This new definition is presented in Table 7.1 along with the author's definition of repair and reconditioning.

Table 7.1 The author's definitions of the alternative secondary market processes

<p>Remanufacturing</p> <p>The process of returning a used product to at least OEM original performance specification from the customers' perspective and giving the resultant product a warranty that is at least equal to that of a newly manufactured equivalent.</p>
<p>Reconditioning</p> <p>The process of returning a used product to a satisfactory working condition that may be inferior to the original specification. Generally, the resultant product has a warranty that is less than that of a newly manufactured equivalent. The warranty applies to all major wearing parts.</p>
<p>Repair</p> <p>Repairing is simply the correction of specified faults in a product. Generally, the quality of repaired products is inferior to those of remanufactured and reconditioned alternatives. When repaired products have warranties, they are less than those of newly manufactured equivalents. Also, the warranty may not cover the whole product but only the component that has been replaced.</p>

7.3.1 Remanufacturing

From table 7.1 it can be seen that remanufacturing is the only process where used products are brought at least to OEM original performance specification from the customer's perspective and, at the same time, are given warranties that are equal to those of equivalent new products.

The giving of a warranty that is equivalent to that of the OEM product is important because practitioners believe that it is evidence that the remanufactured product and the OEM product are of equivalent quality standard. Of all the current "secondary market" (used product) processes, remanufacturing involves the greatest degree of work content and as a result its products have superior quality and reliability. This is because remanufacturing requires the total dismantling of the product and the restoration and replacement of its components.

7.3.2 Reconditioning

Reconditioning involves less work content than remanufacturing, but more than that of repairing. This is because reconditioning usually requires the rebuilding of major components to a working condition that is generally expected to be inferior to that of the original model. All major components that have failed or that are on the point of failure will be rebuilt or replaced, even where the customer has not reported or noticed faults in those components.

7.3.3 Repair

Generally, the quality of repaired products is inferior to those of remanufactured and reconditioned alternatives. When repaired products have warranties, they are less than those of newly manufactured equivalents and may apply only to the part that has been replaced or worked upon.

Figure 7.2 presents the three operations on a hierarchy based on the work content that they typically require, the performance that should be obtained from them and the value of the warranty that they normally carry.

Figure 7.1: The author's hierarchy of secondary market production processes

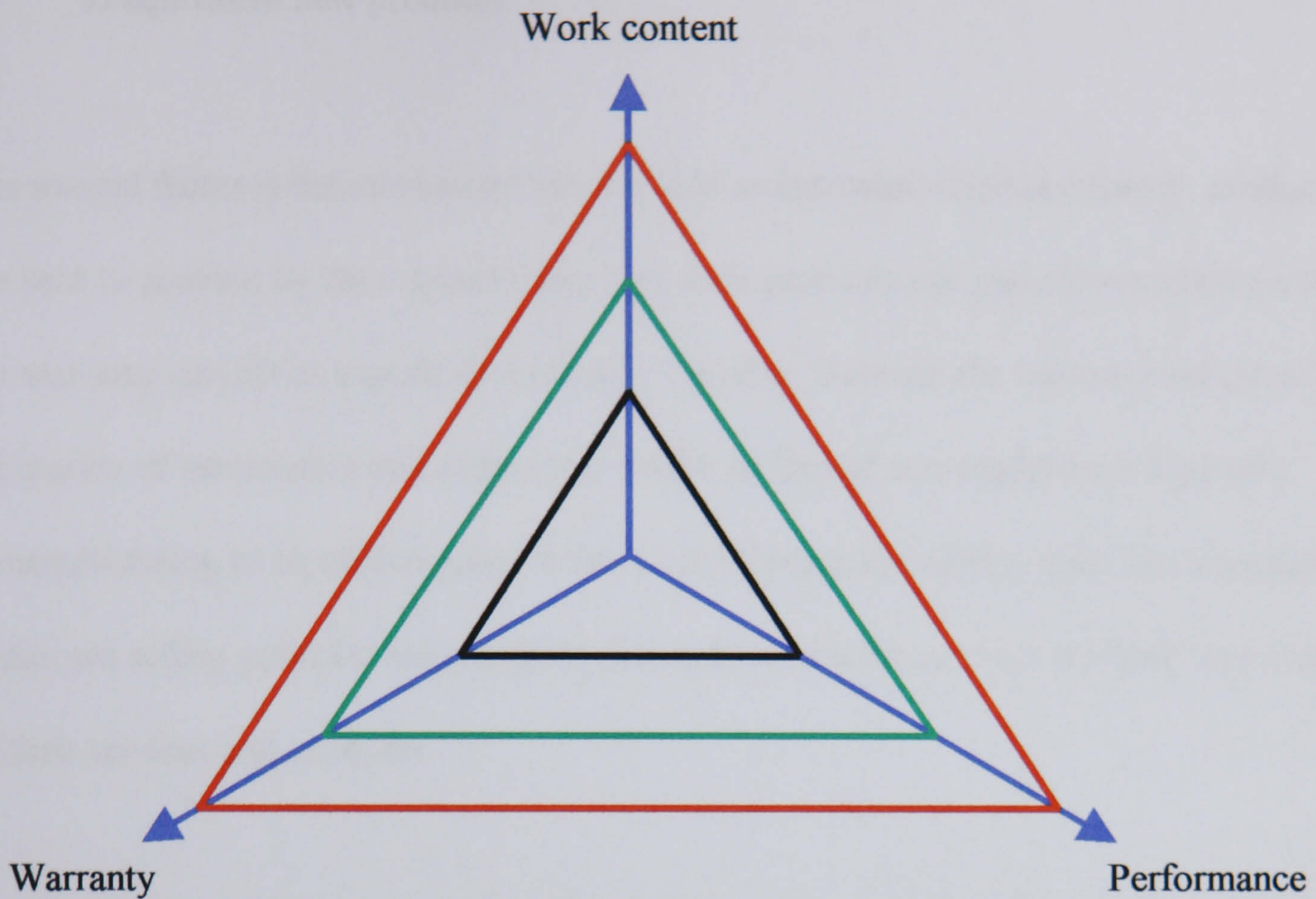

Key:

Remanufacturing	—
Reconditioning	—
Repairing	—

7.4 Summary

This research has identified that remanufacturing operations have some key problems that impact on their profitability and that many of these problems cannot be resolved in the absence of an unambiguous definition of remanufacturing. This issue is described in Chapter 2 for example. The author has addressed this by developing a new robust definition of remanufacturing. The definition is based on two key factors that were identified from the case study evidence presented in chapters 4, 5 and 6. The two factors are:

1. The quality of remanufactured products in terms of their ability to meet similar performance specification to equivalent new products.

2. The requirement for remanufactured products to have similar warranty to that given to equivalent new products.

The second factor is the more important because as has been stated previously, producers are held to account by the warranty they give their products and practitioners believe that the warranty can act as a guide to a product's quality. Because the warranty indicates that the quality of remanufactured products is similar to that of new equivalents it permits remanufacturing to be differentiated from reconditioning and repair. Also, the warranty is an additional selling point for non-contract remanufacturers because it "validates" the quality of their services and products.

The following chapter discusses process modelling. Its objective is to demonstrate that a generic model of the remanufacturing business process could be used to effectively describe the remanufacturing operation so that others would understand remanufacturing. It also describes the IDEF0 modelling technique and explains why it was selected for building the model of the remanufacturing business process.

Chapter 8: Process modelling

8.1 Introduction

The previous chapter presented the author's new robust definition of remanufacturing. The requirement now was to find a way of accurately describing that new knowledge so that it would be useful to others.

Chapter 2 presented the case for using an unambiguous definition of remanufacturing as a platform for developing a comprehensive model of the remanufacturing business process.

The rationale given there was that:

1. There is a need for analytic models of remanufacturing-like processes, (Guide et al. 1999c).
2. Modelling overcomes communication problems such as ambiguity that are associated with conversational language and as a result are recommended for analysing business processes (Smart et al. 1995, Mertins et al. 1996, Kubeck, 1997). They are also said to be useful where there is a need to for a shared understanding of what a business does and where information is required to assist improvement change programs (Ould, 1995).

The research information presented in Chapter 2 has shown that there is a need to share information about the remanufacturing operation so that remanufacturing knowledge could be enhanced. Also, the conclusions of the case studies were presented in chapter 5. There and also in chapters 4 and 6 it was illustrated that practitioners require information with which to improve their management of some key problem areas of the remanufacturing operation.

This chapter addresses these issues by demonstrating why a generic model of the remanufacturing business process that has been developed, using the IDEF0 modelling technique, could be used to effectively describe the remanufacturing operation so that others would understand remanufacturing and also improve that operation if required. It is important to develop methods for improving the management of remanufacturing operations because this research has shown in chapters 4, 5 and 6 that there is a paucity of tools for remanufacturing operations, and that remanufacturers incur costs because of their difficulties in undertaking some critical remanufacturing activities. IDEF0 is a process modelling technique that has proven advantages in business process modelling, because it provides a picture of the activities and flows of a process or system (Smart *et al.* 1995). A generic business process model displays only characteristics that are common to members of the business type that it represents. For example, a generic model of a manufacturing company will exhibit only those traits that are common to a series of manufacturing companies and will show no features that are unique to a particular manufacturing organization. According to Bennett *et al.* (1995) generic models can help to improve understanding because they provide accurate descriptions of the characteristics of typical members of the business type that they represent. However, to make a model a suitable modelling technique must first be identified.

8.2 The characteristics of appropriate modelling techniques

According to Smart *et al.* (1995) a technique with good process modelling capabilities must be able to provide a complete, concise and consistent description of the activities and flows that form a system or process. Weaver (1995) proposes that it is possible only where the modelling technique is:

- Easy to use
- Usable for generic models as well as specific company models

- Capable of supporting decomposition (i.e. different levels of detail)
- Able to be integrated into a set of modelling techniques supporting all phases of a design and implementation project.
- Re-usable in a wide range of applications.

8.3 Examination of the process modelling capabilities of the IDEF 0 modelling technique

The suitability of the IDEF0 modelling technique can be assessed in terms of firstly, its ability to satisfy the characteristics of appropriate modelling techniques and, secondly, by comparing its capabilities against those of some better-known alternatives. Table 8.1 records examples of researchers' opinions about the process modelling capabilities of the IDEF0 technique.

Table 8.1: The process modelling capabilities of the IDEF0 technique

<p>IDEF0 is easy to use</p> <p>Wang and Smith (1988), FIPS PUB 183 (1994)</p>
<p>IDEF0 can be used for both generic and company-specific models</p> <p>Maull <i>et al.</i>, 1995, Childe <i>et al.</i> (1996), FIPS PUB 183 (1994)</p>
<p>IDEF0 can support decomposition</p> <p>Le Clair 1982, Bennett <i>et al.</i> (1995), FIPS PUB 183 (1994)</p>
<p>IDEF0 can be integrated into a set of modelling techniques that can support all phases of a design and implementation project.</p> <p>Le Clair 1982, Smart <i>et al.</i> (1995), FIPS PUB 183 (1994)</p>
<p>IDEF0 is re-usable in a wide range of applications</p> <p>Colquhoun <i>et al.</i> (1992), Zgorzelski and Zeno (1996), FIPS PUB 183 (1994)</p>

From table 8.1 it can be seen that many researchers believe that IDEF0 has the characteristics of an appropriate modelling technique and therefore is an effective method for understanding a process and communicating ideas and viewpoints.

Researchers such as Zgorzelski and Zeno (1996) believe that better-known alternatives to IDEF0 such as flowcharts and DFDs are too primitive and inadequate when used for serious, large scale business process modelling activities. They recommend the use of IDEF0 because they believe that it is a more sophisticated method that has been used extensively and successfully in many areas of business process undertakings. In the case of DFDs they state that such methods are inadequate for developing a sound representation of business processes because they use only data inputs and outputs and cannot distinguish between activity inputs, outputs, controls and mechanisms. They also state that DFDs cannot be effectively used for analysing the processing of real world objects such as products, parts and services, and that the use of DFDs is limited to information processing systems because their main function is to describe how data is processed.

From the author's experience flowcharting is unsuitable for representing complex systems. Initially, flowcharting was used to gather and document research information as can be seen from the flow charts of remanufacturing operations presented in chapters 4 and 6. However, it was found that the technique could not support decomposition (representation of the system and its components at various levels of detail).

The ability to decompose is a basic characteristic of an effective modelling technique because it permits the building of models that can represent the complexity of a system at whatever level is appropriate for the required purpose (Doumeingts *et al.*, 1993, Aguiar *et al.*, 1993).

For example, a high level model of the system may be used to help top-level managers in strategic decision-making. For such personnel detailed information about process activities would be added complexity that is unnecessary to their tasks. Operators on the shop floor, on the other hand, would require in-depth information about operational activities because their task is to perform those activities correctly. Although flowcharting could be used to model either of these only a technique that is capable of decomposition could be used to integrate both.

Also, from the author's experience of using flowcharting to describe remanufacturing operations during the research, the way in which flowcharting displays information is less concise in comparison to IDEF0. This would make the model it produced appear to be excessively complicated in comparison to the IDEF0 alternative, simply because of the excessive quantity of paper that it would require. Because of these reasons the author believes that flowcharting would be much less effective for describing the remanufacturing business process in comparison to the IDEF0 method.

8.4 A description of the IDEF0 modelling technique

IDEF0 is a process modelling technique that illustrates the component activities and flows of a system. Its main advantage is its ability to provide a complete picture of a process in a concise and consistent manner (Smart *et al.*, 1995). An IDEF0 model is composed of up to five main parts: node index, context diagram, activity diagram, for exposition only (FEO) diagram and glossary (FIPS PUBS 183, 1994, Dorado and Young 2000, Bennett *et al.* 1995, Sullivan D. 1994).

8.4.1 The context diagram

The context diagram determines the limits and objective of the model. This is because it identifies the process's boundaries with the outside world and also is the basis for decomposition and the formulation of process hierarchies.

8.4.2 The node index

In the IDEF0 notation an activity may be referred to as a node. The node index is simply a directory of all the activities that make up the process. It shows all the process activities in an indented list and provides both a written summary of the hierarchy of the process and a way of swiftly identifying specific activities.

8.4.3 Activity diagrams

An activity diagram is a graphic presentation of all or part of an IDEF0 activity model. The context diagram is an example of an activity diagram. The main components of the activity diagrams may be viewed in terms of the notation used, and the means by which decomposition to lower order detail in the diagram is achieved (Bennett *et al.* 1995).

8.4.4 For exposition only diagrams (FEO)

“For exposition only” (FEO) diagrams do not conform to the normal IDEF0 syntax. FEO diagrams can provide further information about parts of the process that the modeller believes are important. FEO diagrams can also be used to abstract information to help with the understanding of diagrams.

8.4.5 The glossary

The glossary is simply a dictionary that describes and defines all the activities and arrows of the model. This allows the text on diagrams to be kept to a minimum to aid clarity.

8.5 IDEF0 building blocks

IDEF0 uses boxes to represent activities and arrows to link the activities. IDEF0 has four types of arrow: inputs, outputs, controls and mechanisms.

The diagrams of the model define the process. The arrows represent real objects or information that are transformed by the activity. Arrows connect boxes and represent interfaces or interconnections between them. An arrow may split (branch) or join together (bundle). This indicates that the kind of data or object represented by the arrow may be used or produced by more than one activity (FIPS PUBS 183, 1994, Chen M., 1999, and Sullivan D., 1994).

In IDEF0 the side of the activity box to which an arrow may enter or leave depicts the meaning of the arrow. This is illustrated in Table 8.1 below.

Figure 8.1: Activity box and arrows (ICOMS)

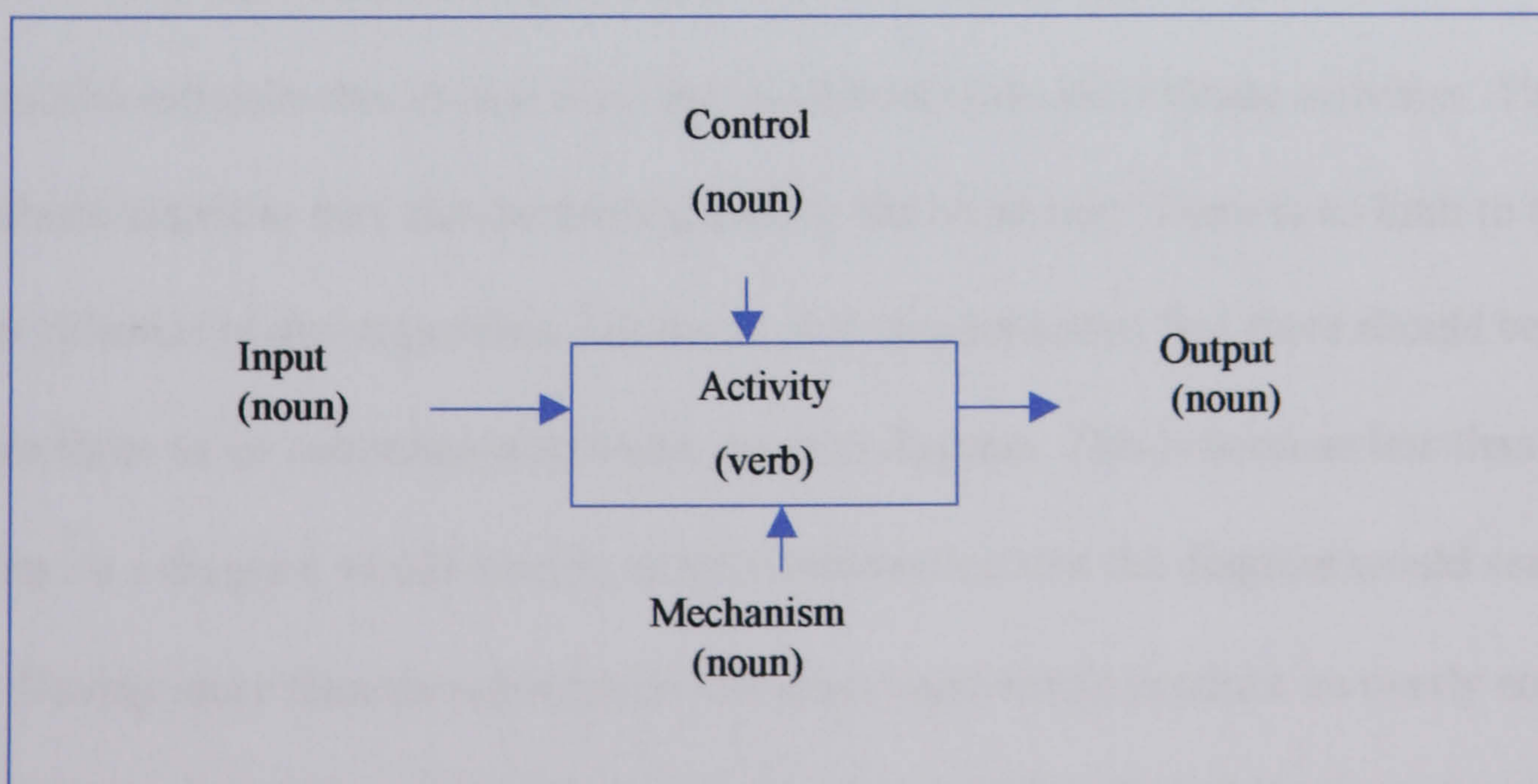

- The inputs (things transformed into output by the activity) are shown on the left side of the activity box. The input arrowhead points towards the activity box to indicate that the

input data or object is going into the activity.

- The outputs (the transformed inputs) are shown on the right side of the activity box. The output arrowhead points away from the activity box to indicate that the flow is emerging from the activity.
- Controls are inputs such as constraints or rules that govern the conditions of the transformation. These are indicated at the top of the activity box and their arrowheads point towards the activity box.
- Mechanisms are the means by which the activity is performed and are illustrated below the activity box with their arrowhead pointing towards the activity box. Examples of mechanisms include robots, conveyors or most commonly people.

8.6 Decomposition

IDEF0 shows a top-down decomposition from the context diagram. The first level decomposition breaks the context diagram (A-0) down into subordinate activities. These subordinate activities may also be decomposed in the same way. There is no limit to the number of levels of decomposition. However, it is recommended that there should be between three to six subordinate activities on each diagram. This is because less than three activities on a diagram would convey so little information that the diagram would seem trivial. Having more than six activities on the other hand would produce an overly complex diagram. However, IDEF0 allows the recommended number of activities to be overridden and this may be done to enhance the clarity or usefulness of the model. An example of this is shown in the level A2 model of the remanufacturing business process that is presented in the appendices. In that case the remanufacturing operation was decomposed into nine

subordinate activities. The reason for that was that practitioners believed that it suited their purposes to see all the subordinate activities of the remanufacturing operation together in one picture. The title of a decomposition diagram is taken from the box that it represents. Activities can be described as being parent or a child. Figure 8.2 is an illustration of decomposition.

Figure 8.2 Decomposition

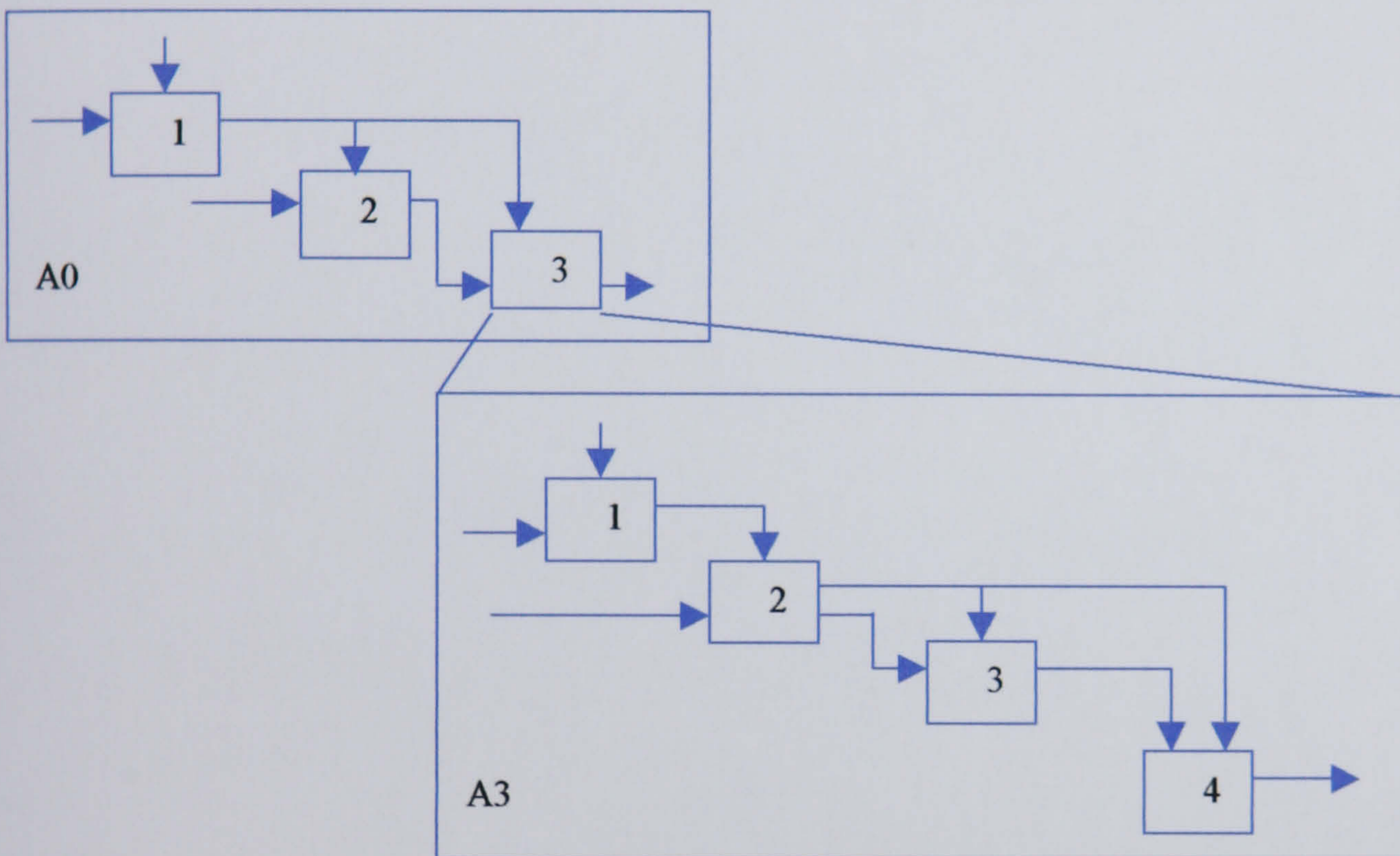

In figure 8.2, Activity A3 is decomposed into four children, A31, A32, A33 and A34.

The result of decomposition is a model where a top-level diagram describes a system in general “black box” terms and where more detailed diagrams describe very specific activities of the system.

8.7 Summary

This chapter has explained the reasons for using the IDEF0 technique to develop the model of the generic remanufacturing business process. This involved illustrating the suitability of the IDEF0 modelling method in terms of its capability to satisfy the requirements of appropriate modelling techniques and describing the advantages of IDEF0 over some

better-known modelling methods. The chapter also described the IDEF0 modelling technique.

The following chapter describes the development of the author's generic model of the remanufacturing business process using the IDEF0 modelling technique. It also explains how the model could be used as an error-reduction guideline that could help to reduce risk in remanufacturing.

Chapter 9: A generic model of the remanufacturing business process

9.1 Introduction

The previous chapter explained the rationale for using the IDEF0 modelling technique to describe the remanufacturing business process. This chapter explains the model development process and the usefulness of the model. It also describes the Phase 3 case study that obtained a company-specific model that formed the basis for the generic model

9.2 Background to the model development process

The CIM-OSA standards AMICE (1989) divide business processes into three main areas: manage, operate and support. These are illustrated in Figure 9.1.

- “Operate” processes are those which are directly related to satisfying the requirements of the external customer. For example the logistics chain from order to delivery.
- “Manage” processes are concerned with strategy and setting direction, as well as with business planning and control.
- “Support” processes exist to support “operate” and “manage” processes.

Figure 9.1. The CIM-OSA business process architecture
(Bititci et al, 2001)

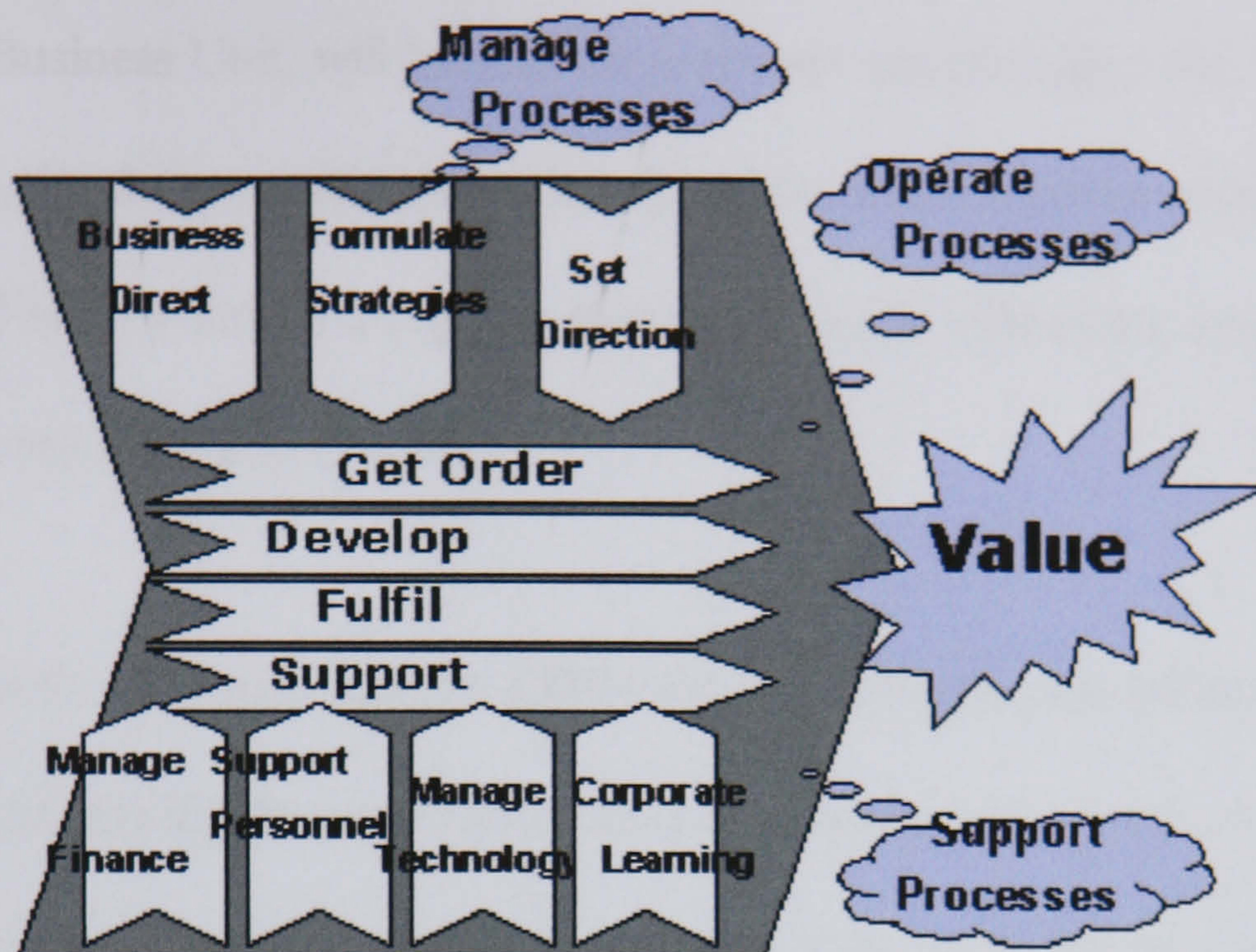
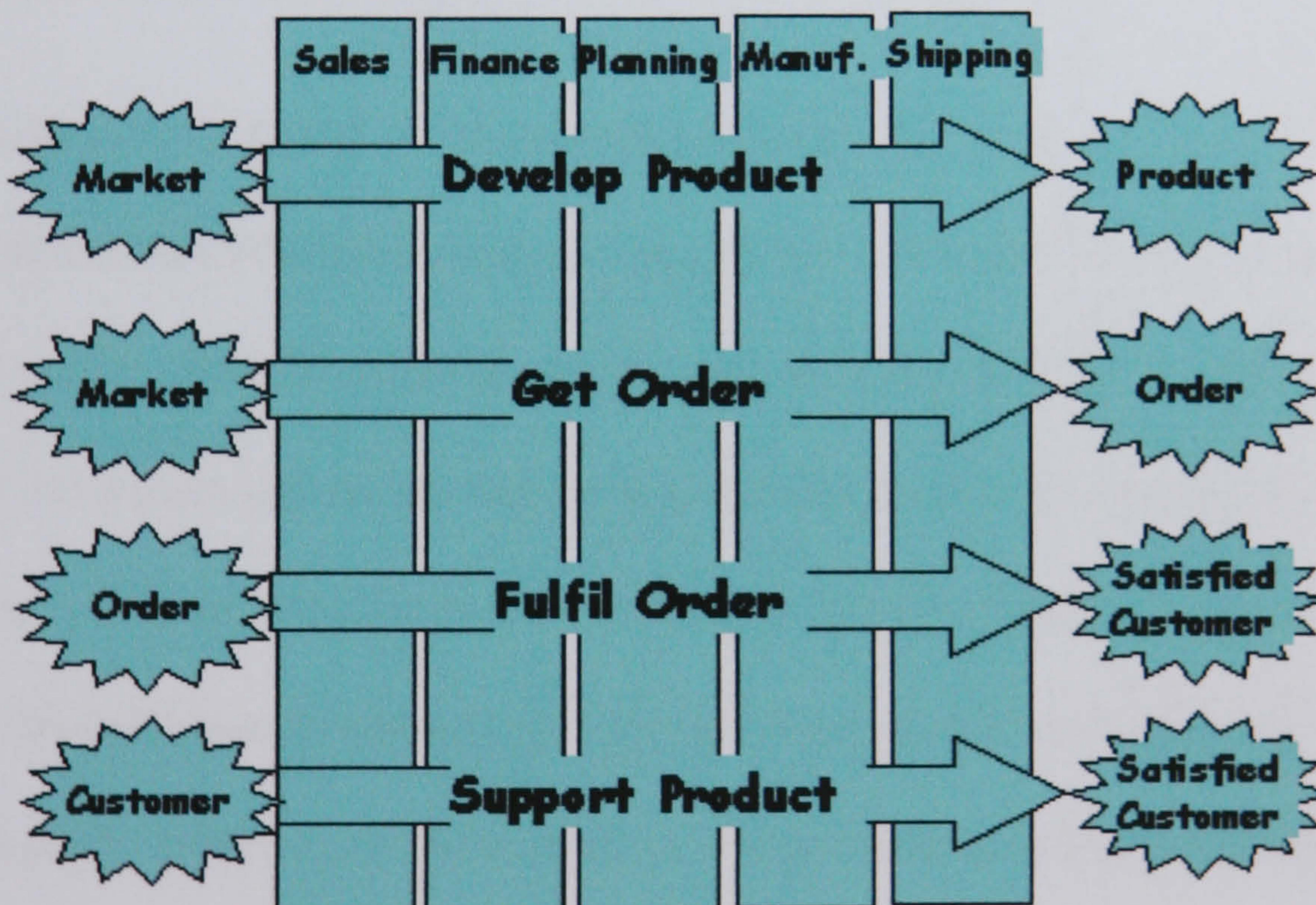

Figure 9.2. Cross-functional nature of business processes representing what actually happens
(www.dmem.strath.ac.uk/CSM/Services/IPMS/ipmsaudit.htm)



Bititci et al. (2001) propose that business processes are not alternative ways of representing existing departments within the business and that they provide a cross-functional view of the organisation as illustrated in figure 9.2. They maintain that because they provide a cross-functional view they represent what actually happens rather than how the business is organised. They go on to say that the CIMOSA Business Process architecture is equally

applicable to organisations other than manufacturing. For example a university's undergraduate activities may be considered as a business unit. The university, within its Undergraduate Business Unit, will have to develop new courses (Develop Product), get students to apply for these courses (Get Order), deliver these courses to these students over 3, 4 or 5 years (Fulfil Order), and support students through references, enquiries etc once they have graduated (Support Product).

The above discussion indicates that the CIM-OSA Business Process architecture can be applied to remanufacturing, because remanufacturing is also concerned with undertaking a variety of business related-activities in order to satisfy the requirements of an external customer.

9.2.1 The boundaries of the model

This research requires a model of the process containing the activities that lead directly to the fulfilment of the external customer's requirement for a remanufactured product. That is the logistics chain, from the customer ordering a remanufactured product, through to the company producing that remanufactured product, to the delivery of the product to the customer. This fits into the definition of the "operate" process described above. The research is not concerned with the activities involved in setting the strategy and direction of the company or its business planning. Likewise it does not require the analysis of the activities involved in supporting the "operate" or "manage" processes. Because of these reasons developing models of manage and support processes is outside the scope of this research. The boundaries of the model developed by this research therefore begin with the activities involved in the customer ordering a remanufactured product, goes through those involved in the company producing that

remanufactured product, and ends with the activities of delivering the product to the customer.

In their development of a reference model for manufacturing Smart et al. (1999) state that the “operate” process is composed of four sub processes:

- “Get order” which is concerned with getting the order from the customer.
- “Develop product” which is transforming the actual or perceived customer requirements into a design that can be manufactured.
- “Fulfil order” which takes the order and manufactures and delivers the product to the customer.
- “Support product” which provides support to the customer after the order has been fulfilled.

Vernadat (1996) and Smart et al (1999) describe a reference model as a model which is not fully instantiated, and which can be reused and customized by business users for building their own particular models.

The model developed by this research was based on the “operate” process of the Smart et al reference model. This involved comparing the requirements of the “operate” process for remanufacturing to the information in the Childe et al reference model (1999) and altering that model until it represented the “operate” process for remanufacturing companies.

9.3 The model development process

A key part of the model development process was the use of a Phase 3 case study to develop a company-specific model of the remanufacturing business process. Once a model

that satisfied the Phase 3 company was obtained it was assessed against the practices of the Phases 1 and 2 case study companies to implement any alterations that would make it valid for a wider range of remanufacturers. The reason here was to enhance the model's probability of being generic.

The Phase 3 case study had a four-week duration and was undertaken in company F. Details of company F and its remanufacturing procedure is provided in chapter 6. As far as company F is concerned this chapter will explain only the undertaking of the Phase 3 case study and the results obtained from that task. However, the reader is urged to refer to section 6.7 for additional information on that company if this is required.

Company F was used to develop the company-specific model because of three main reasons. Firstly, its duration provided adequate time for the detailed study and modelling of a complex process. In contrast, each of the Phase 1 case studies had duration of a single working day, and it would have been very difficult to obtain the depth of information needed to model the remanufacturing business process during one of these case studies. Secondly, basing the model initially on information from only one company permitted the author to control the research information in manageable chunks. The third reason was that company F was one of the companies that validated the Phase 1 case study results. Because of this it is an identified genuine remanufacturer that should contain all the remanufacturing operation information that was available through the Phases 1 and 2 case studies. These reasons imply that a model that accurately represents company F's remanufacturing practices is likely to have a high proportion of the characteristics of a generic model.

The model development process is illustrated in figure 9.3. It has three activities, the phase 3 case study, assess model and refine model. These are described below.

Figure 9.3: The model development process

(adapted from the author-reader cycle FIPS PUBS 183,1994)

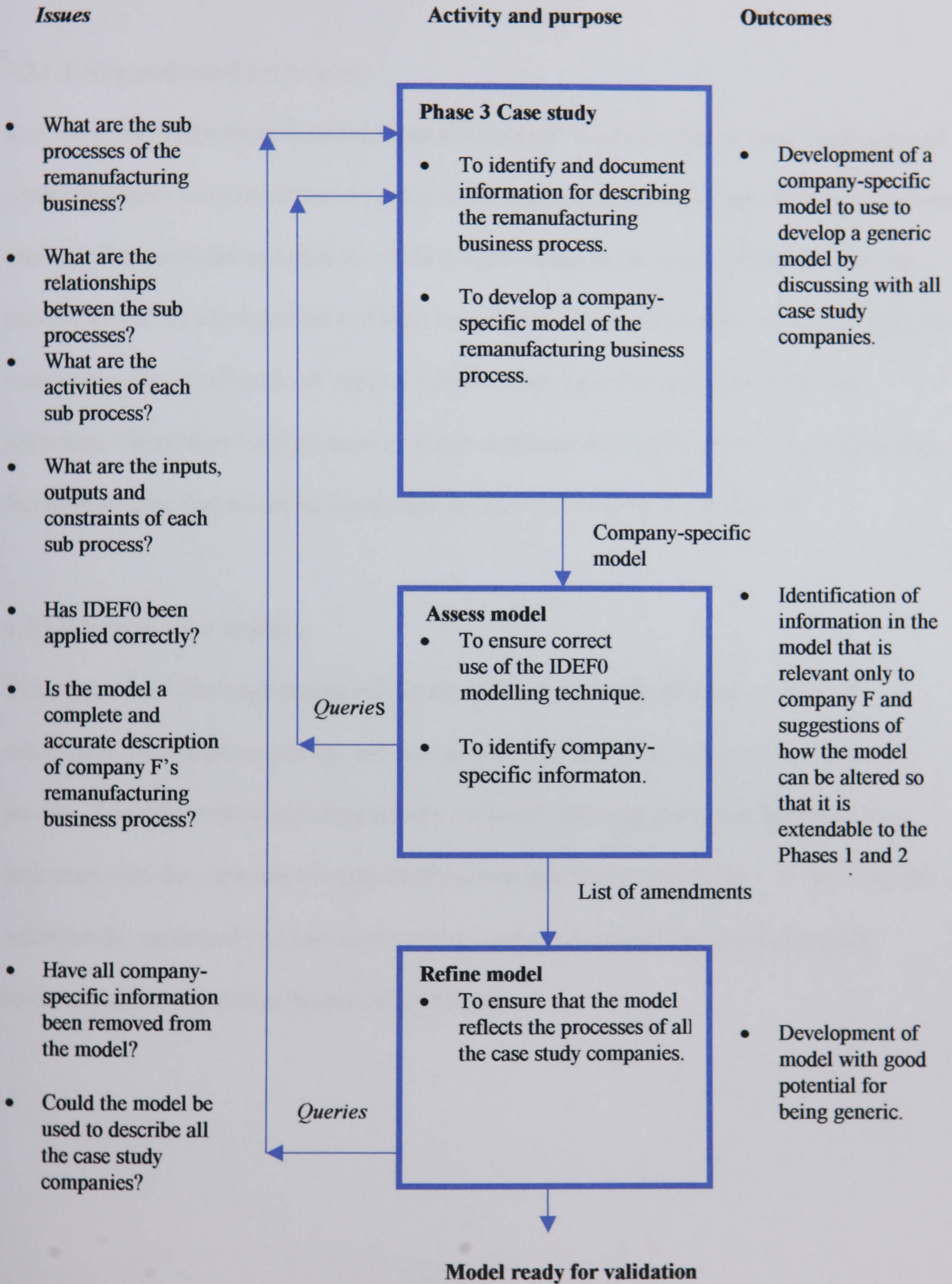

9.3.1 The Phase 3 case study

This in-depth direct observation case study obtained information about the remanufacturing business process using the five activities shown in figure 9.4 and described below.

9.3.1.1 Key personnel interviews.

Key company personnel such as the general managers, quality, logistics, sales, accounts and works managers were interviewed to record information about the remanufacturing business process. This provided an initial list of the sub processes of the remanufacturing business process as well as documentation of their interactions. This included the inputs, outputs and constraints (flows) of each sub process as well as the relationships between the sub processes. These were used to develop a high-level model of company F's remanufacturing business process that would be augmented as more information was obtained.

9.3.1.2 Information capture

The objective of this stage was to record detailed and accurate information about the remanufacturing business process and was achieved by first hand study of the company's process. The information capturing activity involved following some used products from their entry into the company through to their remanufacturing and delivery to the customer. Additionally, personnel involved in the various sub-processes of the remanufacturing business process were interviewed and observed.

Figure 9.4: The Phase 3 case study

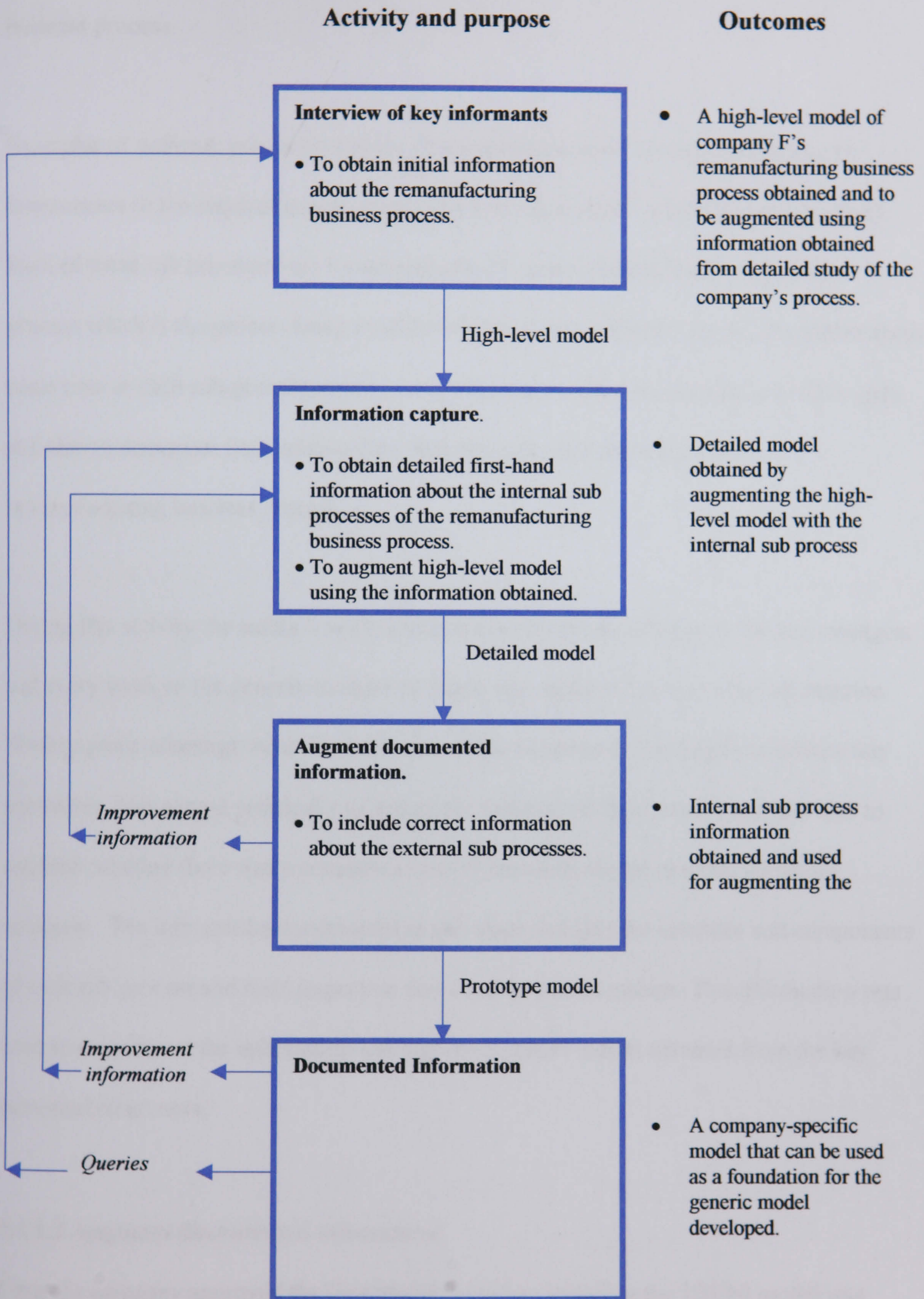

These procedures served two purposes. Firstly, they provided the author with the opportunity to test the information recorded during the key personnel interview and to

identify any anomalies. Secondly, they helped the author to gain greater insight into the inter-relationships between the internal sub-processes of company F's remanufacturing business process.

Examples of such sub processes include, "remanufacture core", (bring used product's components to the required quality standards) and "clean core" (wash the used product).

Both of these sub processes are found inside the "operate" remanufacturing business process which is the process being modelled in this research. Following this the author spent some time at each sub-process to record the information and resource they use and supply, and also to document their relationships with the other sub-processes of the remanufacturing business process.

During this activity the author's work was presented every second day to the line managers and every week to the general manager to assess the validity of the recorded information. Weekly group meetings were also held with all the departmental managers to discuss any anomalies. This served principally to ensure the removal of departmental bias and also to establish whether there was a consensus view of remanufacturing practice within the company. The information documented at this stage includes the activities and components of each sub process and their respective flows and interrelationships. This information was used to supplement the information and high-level IDEF0 model obtained from the key personnel interviews.

9.3.1.3 Augment documented information

Once the company approved the recorded information including the IDEF0 model was augmented with any customer and supplier-related information that may have been overlooked because the remanufacturing business process was analysed exclusively from the

perspective of a remanufacturing company. This involved interviewing the company's customers to understand the customers' perspective of the remanufacturing business process as well as to obtain a better insight into the "external" sub-processes.

External sub-processes occur completely or partially outside the company's premises. They include "Obtain core" (acquire a used product) and "Support customer" (assist the customer through services ranging from technical assistance to honouring warranty).

Augment documented information also involved interviewing and observing company F's employees that deal with external parties on a regular basis. Examples of such employees include sales, purchasing, stores and technical support staff. The opinion of these employees about the information obtained from customers and suppliers was also sought so that dissimilarities between customers' and company F's views of remanufacturing business practice could be analysed.

9.3.1.4 Assess documented information

The documented information and augmented IDEF0 model was presented for assessment to the general, line and departmental managers as well as to some regular customers and suppliers at the weekly meeting. Anomalies were debated to allow final amendments to be made.

The final outputs the Phase 3 case study was an IDEF0 model of company F's remanufacturing business process. That company-specific IDEF0 model is shown in Appendix 1.

- **The flow chart and the IDEF0 diagram of company F's remanufacturing operation.**

A flow chart of Company F's remanufacturing operation had been previously obtained as part of the Phase two case studies and is shown in Figure 6.5 in Chapter 6. However, the author decided that the Phase 3 case study would be more effective if the IDEF0 diagram of Company F's remanufacturing business process was drawn afresh without consulting Figure 6.5. This was because excessive resource would be required to turn the flow chart of figure 6.5 into an IDEF0 diagram of Company F's remanufacturing operation and also there was little opportunity of obtaining a satisfactory result by doing so. The major reasons for this were:

1. Figure 6.5 had been drawn to help understand and describe Company F's operation as a stand-alone event rather than as a basis for developing a generic model. Because of this care was not taken to describe activities using terms that had good chance of being generic, for example. Had Figure 6.5 been used in the Phase 3 case study, many activities would have to be renamed so that non-Company F employees would easily recognise and understood them. For this research it was crucial that the IDEF0 model of Company F's remanufacturing business process is easily comprehensible because non-Company F employees must scrutinise it to identify company F-specific details.
3. Flow charting was used to produce figure 6.5 therefore the rules of the IDEF0 technique had not been observed. For example, Figure 6.5 has ten activities while the IDEF0 notation recommend a figure of between three and six activities per diagram. Any attempt to use Figure 6.5 would require its detailed analysis and redrawing. Even if it were possible to obtain a good outcome from that course of action it would probably require more resource than developing an IDEF0 diagram of the remanufacturing operation from scratch.

This issue has led to dissimilarities between the diagrams of company F's remanufacturing operation shown in figure 6.5 and that found in the company specific model given in the appendices. For example, Figure 6.5 shows ten activities. On the other hand, The IDEF0 version shows eight activities to more closely reflect the limit of six activities per diagram recommended for the IDEF0 technique. This was achieved by bunching up the activities so that only the most important ones are shown. When the activities are decomposed to show more detail, the lesser important activities would be revealed at the lower levels of the hierarchy. Also, while Figure 6.5 uses the term "compressor", the IDEF0 version uses the term "products" which is more likely to be.

Having obtained the company-specific IDEF0 model of the remanufacturing business process the next activity was to examine that model and identify modifications that would make it valid for the Phases 1 and 2 case study companies also.

9.3.2 Assess model

For this activity the prototype model was assessed initially by the author's colleagues for correct use of the modelling technique. Following this it was assessed by the Phases 1 and 2 case study companies, this time for accuracy and sufficiency of the information that it presented. The companies also identified aspects of the model that they believed were specific to company F. This stage also involved putting the model into computer-readable format to increase its ease of use and aesthetic qualities. The output of the assess model activity was a list of amendment suggestions as well as a computer-readable model.

9.3.3 Refine model

The final part of the model development phase was to discuss the proposed amendments with the Phase 3 company before including them in the model. The types of amendments

suggested include changes to the names of activities and the addition of colour, and are explained in chapter 10. The output of the refine model activity was a validation-ready model that represented at least the remanufacturing practices of the case study companies. This model's validity would be assessed by a group of independent practitioners during the final stage of this research.

9.4 Use of the model

Chapter 2 presented a case for developing a robust definition of remanufacturing that would help to differentiate and distinguish it from alternative secondary market processes. That chapter also showed that there is a paucity of remanufacturing-specific tools and techniques. The rationale for this was evidence showing that the tools of conventional manufacturing were not ideally suited to remanufacturing. It was also identified that most current remanufacturing-specific tools had been designed in-house by the remanufacturer, but that most remanufacturers are small practitioners who could not afford the expense of such an undertaking.

The case study evidence presented in chapters 4 and 6 indicates that remanufactured products must be of high quality and reliability, as well as low priced, to compete successfully against alternatives such as reconditioned and new products. However, with current remanufacturing practices, high levels of inspection and testing are required to obtain high quality products and this normally equates to higher production costs and longer production lead-time.

Chapter 5 provided an overview of current remanufacturing practices. Chapters 4 and 6 provided examples of the scale of financial losses that remanufacturers typically suffer when undertaking the "investigate core" activity, a key but complex element of the

remanufacturing operation for which no guidelines are currently available. Both chapters also documented that practitioners require tools that would help them to improve the consistency and effectiveness of training.

9.4.1 The model as a remanufacturing-specific error-reduction tool

The author's robust model of the remanufacturing business process documents comprehensively and unambiguously the resources required to undertake the sub-processes of the "investigate core" activity. It also displays the inter-relationships between those sub-processes as well as the relationship between the "investigate core" activity and the other activities of the remanufacturing operation.

If the model is used as a guiding manual during the remanufacturing operation it can help to reduce the level of guesswork and complexity involved in remanufacturing because the resource required by the activities of the remanufacturing operation are clearly detailed in a logical and easily accessible manner.

9.4.2 The model as a tool for enhancing the consistency and effectiveness of training

The model is a comprehensive document that could facilitate effective training. This is because it unambiguously displays the activities of the remanufacturing business process, including the activities of all its sub processes such as the remanufacturing operation, as well as the interrelationships between those activities.

When used in this manner the model could help to promote a consensus view of the remanufacturing operation and the remanufacturing business process. This development would help to reduce the problems related to over reliance on experience as well as inconsistency and ineffectiveness of training that were identified by the case studies in

chapters 4 and 6, so that that employees could more easily work to a pre-agreed company-wide procedure.

The model may also help to reduce training costs. According to the evidence presented in chapter 5, currently, in remanufacturing companies, training is undertaken hands-on with the more experienced employees teaching newer recruits. The model could be used as an off-site training facility for the more simple remanufacturing tasks. This would help to reduce the amount of time that expensive time served workers spend on training so that they could perform the tasks for which they are employed. It is also likely that the model, when used in this manner, could reduce the losses that result from errors made by new recruits in their attempts to copy their more experienced peers.

9.4.3 The model as an aid for disseminating remanufacturing knowledge

In chapter 2, the research identified that remanufacturers and academics face many difficulties because of the inconsistency in the definitions of secondary market operations. In the case of academics, the model could be used to help them to unambiguously and accurately describe remanufacturing. This development would help them to undertake effective remanufacturing research and also to disseminate their findings. With regards to practitioners this comprehensive model can be used to help assess the validity of existing remanufacturing operations, to improve the management of existing ones, as well as to facilitate the design of effective remanufacturing operations.

Weaver (1995) proposes that specific business processes models can be built from existing generic models. He states that this involves comparing the existing generic model to the business process for which a model is required and adapting the generic model so that it displays the characteristics of the business that requires a model.

According to Smart *et al.* (1995) generic models that can be used as a basis for developing other models are known as reference models. The literature indicates that currently there are no generic models of the remanufacturing business. In fact the output of the research is a reference model for remanufacturing businesses that can help to disseminate remanufacturing knowledge.

9.5 Summary

This chapter has explained the development of the model of the generic remanufacturing business process. It has also summarised the need for the model and explained its use as a remanufacturing-specific tool.

The output of the model development phase of this research was new knowledge in the form of a model that appeared to display visibly and unambiguously the information and resource needed in each area of the generic remanufacturing business process including the remanufacturing operation. However, because the new knowledge has been developed from subjective observation and experience of a limited number of companies the next step of the research was to test the validity of that model for a wider range of practitioners. That issue is addressed in the following chapter.

Chapter 10: Validating the model

10.1 Introduction

The previous chapter described the development of a generic model of the remanufacturing business process. The model was assessed and found satisfactory by the case study companies. This chapter describes the testing of the model by the validation by review method (Landry *et al.* 1983). The purpose of the validation is to ascertain firstly, whether the model is an accurate representation of the business practices of a wider range of practitioners and, secondly, whether it is useful. As discussed in chapter 3 the usefulness of the model would be most appropriately assessed in terms of its ability to satisfy the needs of the practitioner (Thomas and Tymon, 1982). The criteria used to assess the model were its usefulness, clarity, sufficiency and accuracy.

This chapter also details the uses that the evaluating panel has proposed for the validated generic model shown in Appendix 8.

10.2 Criteria for testing the success of the research

Thomas and Tymon (1982) list five key needs that should be used to assess the success of research projects in organisational science. These criteria can be applied to this POM research because POM is a sub-set of organisational science. For this research Thomas and Tymon put forward (1982) five key needs:

- a) Descriptive relevance – is the model a sufficient representation of the remanufacturing business process?
- b) Goal relevance – is the model useful to remanufacturers and academics?

- c) **Operational validity** – Is the model presented in a format that will allow remanufacturers and academics to use and manipulate it?
- d) **Non-obviousness** – is the model new knowledge rather than simple common sense already available to remanufacturers?
- e) **Timeliness** – is the model available at the time that remanufacturers required it?

According to the literature evidence provided in chapter 2 remanufacturing practitioners and academics both require models of remanufacturing. The model's ability to meet the needs of practitioners can be most successfully judged by assessing its ability to satisfy the requirements of these two sections of society. If practitioners or academics found the model insufficient (a poor representation), unclear (incomprehensible) or inappropriate (unusable) then the research would have failed because the model would have been unable to fulfil the purpose for which it was developed.

10.3 The validating panel

All members of the validating panel were independent of the research and the researcher's university. The validating panel consisted of roughly equal numbers of academics, case-study companies and of non-case study companies. Case study companies were represented because of two main reasons. Firstly, this situation provided an ideal opportunity to confirm again that the case study companies agreed with the information that had been captured by the researcher and, secondly, that they were satisfied with the researcher's interpretation of their information. Non-case study companies were required in the validation to ascertain whether the model could be generalised to a series of remanufacturers that were independent from the research. Additionally, the occasion provided ideal opportunity for case study and non-case study practitioners to debate remanufacturing practices and reach a

consensus opinion in the event of anomalies being identified in the model by either group of practitioners.

Practitioners involved in the testing process were all either members of the electromechanical sector of the UK remanufacturing industry or academics in remanufacturing-related disciplines because the research was geared towards them. Also, participants were drawn from middle management and above to ensure that they had adequate knowledge of the remanufacturing business process required to undertake proper assessment of the model. Table 10.1 presents some information about the validating panel.

10.4 The validation process

Prior to the validation the author held telephone discussions with the participants and sent them information describing the research, the function of the validation and the author's requirements from them.

The model was validated at the author's university so that the participants would not be disturbed or distracted by their normal work duties. Also, the close proximity permitted the author to monitor their understanding of the IDEF0 modelling method and also to guide the discussion to ensure that the validation was systematic and rigorous.

Table 10.1: The validating panel

Organisation	Position of Representative
Case study companies	
Company G	Manufacturing manager.
Company B.	Managing director.
Company F	General manager.
Company H.	Director
Non-case study companies	
Company J	Managing director.
Company K.	Technical director, Projects manager
Company L.	Managing director.
Academics	
University of Sheffield (Waste Management & Technology Centre - WAMTEC)	Project manager.
De Montfort University	Researcher in remanufacturing.

The author and other academics such as the research supervisors and mentors were present throughout the validation. These people had sound knowledge of the research and validation requirements as well as in-depth understanding of IDEF0, and therefore could give participants any additional support that they required. For example, they answered participant's queries and concern, and they also acted as note-takers, recording any potentially useful information that emerged during the discussions. The information gathering media used during the validation were white board, flip chart, tape recorder, common note taking and feedback sheets. The validation process involved the five activities that are illustrated in figure 10.1.

Figure 10.1: The validation process

Activity and reason

Outcome

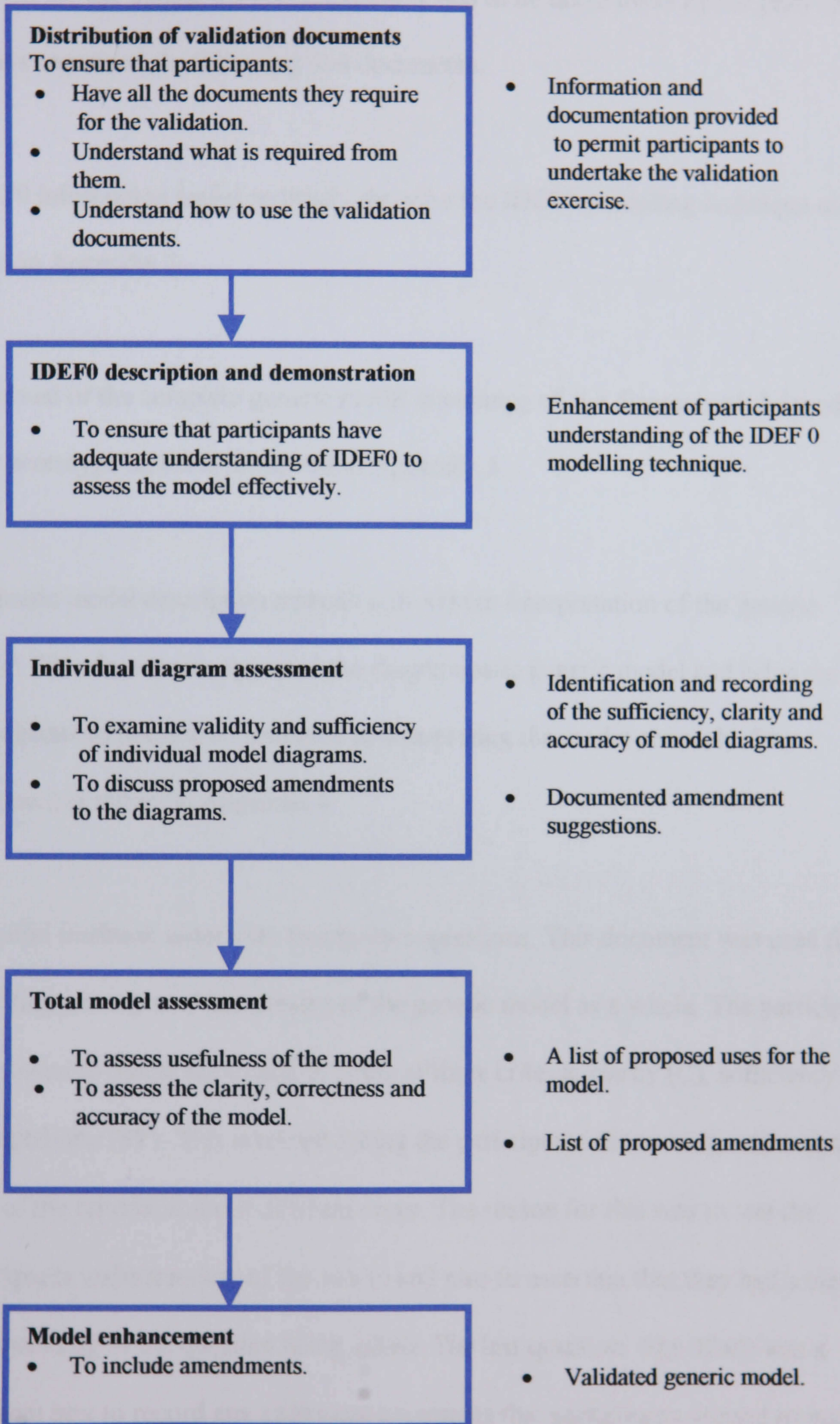

10.4.1 Distribution of validation documents

On the day of the validation participants were given two information booklets, A and B.

Booklet B was for use during the session while A was to be taken away by the participants.

Both booklets contained the following five documents:

1. IDEF0 information leaflet to briefly describe the IDEF0 modelling technique and is given in Appendix 2.
2. A manual of the complete generic model containing all the diagrams of the model. This prototype model is presented in Appendix 3.
3. A generic model description manual with written interpretation of the generic model. This document supported the diagrammatic generic model and helps the participants to become accustomed to interpreting the model correctly. This document is shown in Appendix 4.
4. An initial feedback sheet with twenty-two questions. This document was used for recording participants' assessment of the generic model as a whole. The participants were asked to assess the model in terms of three criteria; clarity (C), sufficiency (SF) and suitability (ST). This involved asking the participants the same question about each of the criteria in seven different ways. The reason for this was to test the participants understanding of the model and also to ascertain that they had a clear understanding of the question being asked. The last question (the 22nd) was a comment box to record any additional comments that participants wished to make. The example of the initial feedback sheet illustrated in tables 10.2 and 10.3, details

the number of the evaluating panel making each response. All the completed initial feedback sheets are in Appendix 5.

Table 10.2: The initial feedback sheet

Validation Feedback Sheet

Name:

Organisation:

Position:

Please tick one box on each line to show how far you agree with each statement.

		Strongly Agree	Agree	Neither	Disagree	Strongly Disagree
1 SF	Many major information flows and activities have been omitted in this model.			8	4	3
2 C	This model displays the required information clearly.	1	7			
3 ST	This model is an adequate representation of the remanufacturing business process	2	6			
4 C	I find many details in this model ambiguous		2	2	4	1
5 ST	This model does not reflect the remanufacturing business process to any great extent				6	2
6 SF	Only a few major activities and information flows have been omitted in this model	2	3	2	1	
7 ST	This model is correct in the way that it shows the basic elements of the remanufacturing business process	3	4	1		
8 C	I find this model easy to comprehend	1	7			
9 SF	I feel that this model captures the major information flows and activities of a remanufacturing business process	1	6			
10 C	I can analyse the information flows and activities of the remanufacturing business with this model	2	5	1		
11 SF	Only a few major information flows and activities are missing in this model	2	2	1	4	

Table 10.3: The initial feedback sheet (continued)

Validation Feedback Sheet

Name: **Organisation:** **Position:**

Please tick one box on each line to show how far you agree with each statement.

		Strongly Agree	Agree	Neither	Disagree	Strongly Disagree
12 ST	This model is an acceptable description of the basic remanufacturing business process	1	7	1		
13 SF	This model requires many alterations before it can describe the remanufacturing business process			2	6	1
14 C	This model is extremely difficult to understand	1			7	1
15 ST	I would not use this model to give a basic description of the remanufacturing business process				5	4
16 C	Generally, this model is logical in the way that it describes the remanufacturing business process	1	7			1
17 SF	This model is a poor representation of the remanufacturing business process				6	3
18 ST	I do not recognise this model as being that of the remanufacturing business process				4	5
19 C	I find this model easy to follow	2	7			
20 ST	I would consider using this model to describe the remanufacturing business process	3	6			
21 SF	Many major details are missing in this model			2	4	3

22 Any additional comments:

*Good way to break down process for quality assurance, costing, information capture.
Some titles need to be put in basic GCSE English!
Time to discuss with staff in my company for their opinions and comments.
Different eyes see different things.*

THANK YOU FOR YOUR TIME

5. Secondary feedback sheets pack. This document contained a feedback sheet for each individual diagram of the model and sought information on the completeness, clarity,

suitability and sufficiency of that diagram. Each secondary feedback sheet had four comment boxes. Figure 10.2 illustrates a typical secondary feedback sheet. Table 10.4 summarises the comments and amendment suggestions that the evaluating panel gave on their secondary feedback sheets. The completed secondary feedback sheets are available in Appendix 7.

Figure 10.2: A typical secondary feedback sheet

Validation Feedback Sheet (Node A21)

Name:

Organisation:

position:

(Please complete the following boxes)

1. Do you believe that the model used today describes the remanufacturing business process. (please tick)

Strongly agree

Agree

Neither

Disagree

Strongly disagree

2. Are there any areas of the model that you believe are specific only to a small group of companies. (Continue on a separate sheet or return the diagrams with comments if necessary).

3. If the model was not complete, what are the exceptions?

4. Are there any areas of the model that you believe are unclear to use (Continue on a separate sheet or return the diagrams with comments if necessary).

THANK YOU

10.4.2 Demonstration and description of IDEF0

The validation procedure began with a description and demonstration of the IDEF0 modelling method. This was followed by detailed demonstration and interpretation of the generic model. Both of these measures helped to give the participants experience and expertise of the IDEF0 technique so that they could assess the model effectively.

10.4.3 Assessment of individual model diagrams

Following the demonstration, each diagram of the model was displayed and described independently. Each time the practitioners were asked to discuss the diagram as a group before giving both their individual and group assessments. The author recorded the group verdict on each diagram and the participants were asked to record their individual opinions on the appropriate secondary feedback sheet.

10.4.4 Assessment of the total model

Once all of its diagrams were assessed the model was analysed as a whole. At this point the participants were asked to record their impressions of the complete model on their initial feedback sheets. Before leaving, the participants handed in the initial feedback sheets but retained the secondary feedback sheets. The secondary feedback sheets pack would be returned to the author with details of any further improvement suggestions that may emerge when the participants had discussed the model with their work colleagues.

10.4.5 Analysis of validation results

Once all secondary feedback sheets had been returned, the information from the validation exercise was combined and used to enhance the model. The following sections record the practitioner's opinions of the model.

10.5 The results of the validating panel's assessment of the model

The validating panel believed that the model was very accurate in the way that it represents the remanufacturing business process. This is shown by the information given in their validation sheets. For example in the initial feedback sheets, shown in tables 10.2 and 10.3, it can be seen that all the members of the validation panel either strongly agreed or agreed that the 'model captures the major information flows and activities of a remanufacturing business process' and that the 'model is an adequate representation of the remanufacturing business process'. At the same time they all disagreed or strongly disagreed that 'the model does not reflect the remanufacturing business process to any great extent' and that they 'do not recognise this model as being that of a remanufacturing business process'. Copies of the completed initial feedback sheets are provided in Appendix 6. They also found the model easy to understand and felt that it could help satisfy their requirements. For example, from the initial feedback sheets they all strongly agreed or agreed that 'they find the model easy follow' and at the same time they also disagreed or strongly disagreed that they 'would not use this model to give a basic description of the remanufacturing business process'.

The amendments that they suggested, from the secondary feedback sheets, (shown in Appendix 6), and the action taken by the author, are summarised in table 10.4. The changes to sufficiency and suitability of the model are shown in table 10.4, and relate to the names of activities and flows. The validating panel indicated that most of these changes would not enhance the model's accuracy or sufficiency. However, there was one cause for concern when some remanufacturers felt that the cleaning process indicated on a diagram was specific only to a cross section of the electromechanical sector of the UK remanufacturing industry. That issue has now been resolved, as excessive cleaning has been removed, because it is specific to products such as compressors. In Table 10.5 the alterations that the panel suggested to enhance the clarity of the model are shown, along with the action taken.

Table 10.4: Alterations to enhance the sufficiency and suitability of the model

Node	Proposed alterations	Action Taken
A-0	<ul style="list-style-type: none"> • Legal requirements should be input as control • Get rid of technical quote request because that is a form of sales inquiry. Technical quote merely asks for the cost of a particular service hence is itself a sales inquiry. • Remove the output “ technical quote” that is simply a “tender”. 	<ul style="list-style-type: none"> • Legal requirements entered, as modelling best practice • Technical quote removed as it is a duplication
A0	<ul style="list-style-type: none"> • Loop remanufacture order back to “ obtain raw materials” • Link the control “industry standards” to the activity “obtain raw materials” • More detail about the relation ship between OEM and remanufacturers i.e. contracts 	<ul style="list-style-type: none"> • Loop entered to enter legislation into model • Control linked to activity for legislative reasons • Contracts not entered as it is beyond scope of model
A11	<ul style="list-style-type: none"> • Further decomposition to give more detail of the reverse logistic chain 	<ul style="list-style-type: none"> • Not used as it is difficult to maintain the ‘generic’ model at very low levels. Also, reverse logistics is beyond scope of research
A2	<ul style="list-style-type: none"> • Insert pre-processing before strip core. For many products it is fairly easy to check whether a product is worth the effort and cost of dismantling. Pre-processing serves this purpose. • Insert a rework/decision box between Test and Final inspection thereby avoiding looping back to assemble product because companies will handle their rework differently depending on their type of product and their company policies. • Replace “ final inspect and paint” with “final inspect and finish” • Replace the flow “incorrect kit” with “incorrect components” • Replace experience with documentation and training • Replace company policy with continuous improvement or quality standards and customer specification. 	<ul style="list-style-type: none"> • Pre-processing implemented as it improves accuracy of model • Rework/decision box implemented to improve model clarity and correctness • Inspection and paint replaced to improve model generic nature • Flow “incorrect kit” remains • Experience replaced to make best practice more obvious • Company policy replaced as for experience
A22	<ul style="list-style-type: none"> • Change “visually inspect” to “preliminary inspect” because in some companies a reasonable inspection is carried out to ensure that scrap components are identified and removed from the remanufacturing system as quickly as possible. This prevents such components using up valuable resource such as cleaning solvents and space. • “Work Assessment Sheet” is too vague. How about “component history document” 	<ul style="list-style-type: none"> • Preliminary inspect implemented to improve model precision • Work assessment sheet changed due to panel majority decision
A23	<ul style="list-style-type: none"> • Change “ bin parts” to “recycle part” then have scrap go into it rather than at the moment when components from “bin parts” go out as scrap. 	<ul style="list-style-type: none"> • Changed to improve clarity
A233	<ul style="list-style-type: none"> • Remove excessive cleaning. This is specific to products such as compressors. 	<ul style="list-style-type: none"> • Removed to improve generic nature of model
A234	<ul style="list-style-type: none"> • Rethink the name of this activity. Remanufacturers are waste minimisation technology operators. What they cannot use for remanufacture will be used for recycling/ reconditioning if not by themselves then to the companies that they sell their rejects to. Remanufacturers rarely throw non- suitable components away. 	<ul style="list-style-type: none"> • Changed to improve clarity

Table 10.5: Alterations to enhance the clarity of the model

Proposed alterations	Action Taken
<ul style="list-style-type: none"> Use colour to enhance easy of use. Give each control a particular colour that it carries through out the diagram. This would make it easier for operators since colour has a more immediate impact and saves having to read text. Colour coding is a common ploy in modern instruction documents. 	<ul style="list-style-type: none"> None taken as unnecessary.
<ul style="list-style-type: none"> Include a glossary to describe activities and flows and also to indicate their function. 	<ul style="list-style-type: none"> None taken because different companies will want to use their own terminology.
<ul style="list-style-type: none"> Chose more suitable names for certain flows and activities. However, some remanufacturers disagreed with this suggestion. 	<ul style="list-style-type: none"> Not necessary, but some taken, however does not improve clarity of model because different companies will want to use their own terminology.

10.5.1 IDEF0 as a modelling technique

Prior to the validation all the participants were unfamiliar with the IDEF0 modelling technique. However, none found the concept too difficult to understand and all very quickly became competent with the technique. Possibly, this is due to the technical expertise and business process knowledge of the participants, as well as the steps taken to ensure that they were given sufficient knowledge to easily interpret the model.

All members of the evaluating panel were of the opinion that the IDEF0 modelling technique would be an ideal method for disseminating remanufacturing information because it presents information in a consistent and concise manner. This can be seen from the initial validation sheets. For example, they all strongly agreed or agreed that firstly “generally the model is logical in the way that it describes the remanufacturing business process” and secondly they “would consider using the model to describe the remanufacturing business process”. They believed that these characteristics make it an effective method for explaining complex information clearly and therefore for promoting understanding. For example from their initial feedback sheets they either strongly agreed or agreed that they “could analyse the information flows and activities of the remanufacturing business with the

model” and that they “found the model easy to comprehend” also the majority either strongly disagreed or disagreed that they “found many details in the model ambiguous”

10.5.2 Descriptive relevance

The validating panel believed that the model was a sufficient representation of the remanufacturing business process and could be used to describe it. For example from their initial feedback sheets they either strongly disagreed or disagreed that “the model is a poor representation of the remanufacturing business process” and they either strongly agreed or agreed that they “would consider using the model to describe the remanufacturing business process”. They recommended some alterations but felt that these did not indicate any great errors in the model, but may help to enhance its clarity and, as a result, its ease of use. The alterations that they recommended and the action taken by the author are detailed in tables 10.4 and 10.5.

Company F offered to use the model as a marketing tool that illustrates the validity of their remanufacturing operation. Company K was keen to base their new remanufacturing facility on the model and has since successfully used the model to obtain government funding to conduct further research that will lead to the establishment of a national network of effective remanufacturing operations. Details of this award are in Appendix 7 and the author is currently employed as research manager on that project. The project has since been expanded to include the use of the model to address the incoming waste limitation laws by, for example, increasing the scope and effectiveness of remanufacturing of components as well as whole products.

10.5.3 Goal relevance

All members of the panel believed that the model would be an effective tool for enhancing the efficiency and effectiveness of new and existing remanufacturing facilities. For example, its use as a reference model could help practitioners to analyse their operations so that they could enhance their understanding and implement improvements if required. Table 10.6 gives details of proposed uses for the model and the company putting forward the suggestion.

Table 10.6 Proposed uses for the model

Company	Proposed use for the model
Case study companies Company G Company B Company F	Use to supplement and thereby enhance the clarity of quality control system and procedures Use to replace lengthy procedure documentation Use for sales promotion/marketing Use as a map of remanufacturing
Non-case study companies RS DP JM	Simulation Use for designing effective remanufacturing operations Add a bit more text and use in place of present generation of quality control systems and procedures because these tend to be unwieldy and often confusing
Academics Sheffield University De Montfort University	Use as a training document. Customise for the specific needs of individual companies (reference model)

10.5.4 Operational validity

Operational validity describes practitioners' ability to use the new knowledge easily. This requires that the new knowledge must be firstly, understandable to practitioners and secondly, presented in a format that enables them to manipulate it easily. The completed initial feedback sheets indicate that they understood the model because the majority of them either strongly agreed or agreed that they "find the model easy to follow". The feedback sheets also indicate that the model was presented in an easy to use format because they either strongly agreed or agreed that they "can analyse the information flows and activities of the remanufacturing business with this model" and also they all either strongly disagreed or disagreed that they "would not consider using this model to describe the remanufacturing business process". Also, they all took away copies of the model and were able to explain and discuss these with work colleagues who did not attend the session. These reasons indicate that practitioners can understand and use the model easily. This can be taken as evidence of its operational validity.

10.5.5 Non-obviousness

Prior to the validation session, none of the practitioners was familiar with the IDEF0 technique this can be taken as clear indication that they would not have considered using the generic model for documentation purposes or for identifying efficiency and effectiveness enhancement measures. They also believed that "walking through" and discussing the model highlighted problem issues that they had been unaware of or that they had incorrectly assumed to be "the normal play of things". The academics for their part felt that the model helped them to gain a much clearer idea about the concept of remanufacturing, how it is undertaken as well as the complexities of the process. The difference between the reactions given by the academics and remanufacturers result from the fact that both groups of practitioners had dissimilar requirements from the research. The academics came because

they were looking for understanding, while the remanufacturers required methods to help them improve their operations.

10.5.6 Timeliness

During the validation no questions were asked about the timeliness of the model. However chapters 2, 4, 5 and 6 illustrated that practitioners require the model. Also, the fact that the practitioners and in particular practitioners from distant areas of the UK came to the validation could be taken as evidence that the model is required now. Also the fact that practitioners were willing to pay the author to undertake part of her research at their companies may also be taken as evidence of the need for the model. Likewise the ability to obtain substantial funding to extend the research from a government body may be taken as evidence of the timeliness of the research.

The generic model is timely because the validating panel believed that it addresses the key remanufacturing problems. For example, it provides an unambiguous definition of “remanufacturing”. Also, it could help to improve the efficiency and effectiveness of remanufacturing operations when used as an integral part of their design and implementation. Table 10.6 presents the practitioners’ proposed uses for the model.

10.5.7 Negative points of the evaluation

Two negative observations were observed from the validation. These were inconsistent answer by one company and two panel members finding the model details ambiguous.

- **Inconsistent answer**

A representative of one of the case study companies was the only member of the evaluating panel that gave inconsistent answers. For example, from Table 10.3 this individual “strongly agrees that the model is extremely difficult to follow ” and also “strongly disagrees that generally, this model is logical in the way that it describes the remanufacturing business process”. However, the same table shows that all the validating panel “disagree or strongly disagree that they would not use this model to give a basic description of the remanufacturing business process”. Therefore this individual has contradicted his earlier answers.

The reason here could be that because the representative was new to the company he may not have had adequate understanding of his new company’s process. In this instance there had been a major reorganisation in that case study company. The middle manager that was previously selected for the validation panel had left the company and the company had selected the new management recruit as replacement at short notice. Also, as the representative did not have a remanufacturing background it is possible that he had volunteered to come because he saw the validation session as an easy way to obtain remanufacturing information because this would help him more easily adapt to his new company.

- **Ambiguous model details**

Two members of the panel believed that the terms used to describe information flows was ambiguous. This relates to the naming of some activities and flows. For example the use of the word “bin” was felt to be inappropriate because it implies the discarding of components and products rather than a holding area for non-suitable items until a decision is taken about

what should be done with them. These issues relate to diagrams A22, A23 and A 234 and have now been resolved in the ways indicated on Table 10.4.

10.6 Conclusions of the validation exercise: validity of the model

A panel of nine evaluators assessed the model using the validation by review technique (Landry *et al.* 1983). The validation criterion was its ability to satisfy the needs of the practitioner (Thomas and Tymon, 1982). All members of the evaluation panel reported that from their experience and knowledge of remanufacturing, the model was a valid representation of the remanufacturing business process. They also indicated that the model would be useful to them.

As far as the usefulness of the model is concerned chapters 4, 5 and 6 illustrated that remanufacturers require remanufacturing-specific tools to help them enhance the effectiveness of their operations. Chapter 2 explained that academics require an unambiguous definition of remanufacturing as well as analytic models that will help them to understand remanufacturing so that they can effectively research that concept and also correctly disseminate their findings. The generic model is useful because the validating panel believed that it addresses these problems. For example, the initial feedback sheets indicate that practitioners believe that it can be used to provide an unambiguous description of “remanufacturing”. Also, the usefulness of the model to practitioners can be illustrated by the uses that practitioners have proposed for it. This information is presented in Table 10.6.

In the case of the validity of the model the results obtained by this research can be considered valid because of two main reasons. These are, firstly, the quality of the research design and secondly, the fact that it has passed the test for replication logic.

- **Quality of research design**

Gummesson (1993); Holloway (1997); Yin (1981); Eisenhardt (1998); Lang and Heis (1994) and Easterby-Smith *et al.* (1993) stress the importance of criteria such as validity, reliability and generalisability in establishing the validity of a piece of research.

Yin (1994) proposes that four logical tests, construct validity, internal validity, external validity and reliability are particularly applicable to case study analysis. Construct validity and reliability are concerned with data collection quality control and the methods used to improve these criteria in this research were described in sections 3.5.1 and 3.5.2. External validity is concerned with “the extent to which the research findings can be applied to other instances of the phenomenon”. According to Yin (1994) this factor can be used to judge the quality of research design because effective research design should dictate where the research findings should be applicable.

This research investigated the electromechanical sector of the UK remanufacturing industry. The measures taken to ensure the external validity of the research findings include testing the new definition in new remanufacturing companies and also having the generic model assessed by non-case study companies and academics. These new groups of practitioners also found the research results valid and useful.

- **Replication logic**

Creswell (1994) states that case studies rely on analytical generalisation which he describes as the situation where the researcher is striving to generalise a particular set of results to some broader theory. He further proposes that generalisation is not automatic and that the theory developed must be tested through replication in at least one other instance where the theory has specified that the same result should occur. He also states that once replication

has been made, the results might be accepted for a much larger number of similar neighbourhoods, even though further replications have not been performed. Replication logic was used to test the research results through the validation by review technique and the information provided in the validation panel's feedback sheets as well as the uses proposed for the model in Table 10.6 indicate that its results held true. By the laws of replication logic those results can be accepted as valid for a much larger number of similar neighbourhoods, the neighbourhoods in this case being the electromechanical sector of the UK remanufacturing industry.

10.7 Summary

This chapter has described the validation of the generic model of the remanufacturing business process using the validation by review technique (Landry *et al.* 1983). The model was assessed according to its ability to satisfy the needs of the practitioner (Thomas and Tymon 1982). The evaluating panel of nine remanufacturing experts were drawn from case study companies, non case study companies and academia.

These people were confident that the model was a true and comprehensive representation of the remanufacturing business process. They indicated that they believed that the model was useful, unambiguous and relatively easy to comprehend. This generic model is presented in Appendix 8.

The following chapter presents the major conclusions of the research.

Chapter 11: Conclusion

11.1 Introduction

According to Haynesworth and Lyons (1987) remanufacturing is the process of bringing used products (called “cores”) to “like-new” functional state by rebuilding and replacing their component parts. Lund (1984) proposes that the practice is particularly applicable to complex electro-mechanical and mechanical products which have cores that, when recovered, will have value added to them which is high relative both to their market value and to their original cost. Studies, by for example, McMaster (1989) indicate cost savings in the region of between 20% to 80%, as well as quality comparable to that of an equivalent “new” product.

Although remanufacturing has had a low profile in all world economies, studies by researchers including Hormozi (1996), Ferrer (1996) and Ayres *et al* (1997) indicate that remanufacturing has been a viable economic activity for many decades. This is confirmed by Guide (1999), who demonstrated that in excess of 73,000 firms are engaged in some sort of remanufacturing in the United States alone.

This research has sought to understand remanufacturing as a business process in contrast to most earlier work that has investigated it mainly from design and ecological perspectives.

It has examined the scope of current remanufacturing research and analysed remanufacturing practices and problems. This analysis has identified the need to undertake research to address some key remanufacturing problems.

11.2 The key remanufacturing problems

The major remanufacturing problems include the insufficiency of remanufacturing knowledge that has led to its confusion with the alternative product recovery operations of repair and reconditioning, and the scarcity of remanufacturing-specific tools and techniques, which causes inefficiency and ineffectiveness of remanufacturing operations.

The research has developed a robust and unambiguous definition of “remanufacturing”, a standard remanufacturing operational flowchart and a comprehensive model of the remanufacturing business process. These developments are new knowledge that can help to resolve the above problem. For example, the comprehensive model acts as a method for unambiguously describing remanufacturing, as well as an analytic remanufacturing-specific tool that would facilitate the design of effective remanufacturing operations and the dissemination of remanufacturing knowledge. The robust definition permits remanufacturing to be unambiguously differentiated from repair and reconditioning. This permits effective remanufacturing research to be undertaken and also for findings to be correctly disseminated.

11.3 The significance of the research

The research is significant because it has tackled the major issues that must be addressed to improve the efficiency and effectiveness of remanufacturing operations, as well as the inadequacy of remanufacturing knowledge. These issues include the shortcomings of current definitions of remanufacturing and the inadequacy of remanufacturing-specific tools and techniques (Melissen and Schipper, 1999).

- **Inadequacy of remanufacturing-specific tools and technique**

Guide and Gupta (1999), Melissen and Schipper (1999) and Wiendahl and Burkner (1999) propose that remanufacturing operations require tools and techniques that have been specifically developed for their needs, because the tools of conventional manufacturing are not ideally suited to the remanufacturing environment. Farley and Fourcaud (1992) have observed that typically, remanufacturers develop and build tools in-house because there is a scarcity of remanufacturing-specific tools. However, Lund (1984) has shown that the majority of remanufacturers are small independent practitioners. Typically, such companies lack the resources to undertake the extensive research and development that is required to build remanufacturing-specific tools in-house.

- **Shortcomings of current definitions of remanufacturing**

Nasre and Varel (1997), among others, have shown that remanufacturing is a misunderstood and poorly researched production process. Melissen and Schipper (1999) propose that a key problem here is the confusion and ignorance that arise from the ambiguity in current definitions of secondary market operations. This is in agreement with Lund (1984), who states that one of the barriers to the growth of remanufacturing in some product sectors is consumer prejudice against used products coupled with their inability to differentiate between remanufacturing and related secondary market operations.

Researchers, including Melissen and Schipper (1999), report that there is urgent need for research into remanufacturing-like processes to develop tools specifically for them and also to define and distinguish between the different processes. Specifically, in the case of remanufacturing, practitioners perceive the scarcity of effective remanufacturing tools as a key threat to their industry. Researchers such as Melissen and Schippers (1999) propose that these problems are caused by the inadequacy of remanufacturing research.

This research has addressed these issues in two ways. Firstly, it has helped to enhance remanufacturing knowledge by obtaining a robust definition of remanufacturing that for the first time permits it to be differentiated from alternative secondary market processes.

Secondly it has developed a comprehensive generic model of the remanufacturing business process that can be used as a remanufacturing-specific error-reduction tool.

11.4 Objective of the research

The aim of this research was to unambiguously define remanufacturing and also to help to alleviate the problems that result from the paucity of remanufacturing knowledge.

This involves satisfying the following objectives:

1. Unambiguously defining remanufacturing.
2. Developing a standard flow-chart of the remanufacturing operation.
3. Identifying the key problems of the remanufacturing operation.
4. Articulating the findings for use by remanufacturers and academics.
5. Validating the findings.

11.5 Research question

The major questions that were answered to satisfy the objectives of this research were:

- What is remanufacturing?
- How is remanufacturing undertaken?
- What are the key problems of the remanufacturing operation?
- How can the new knowledge be made useful to others?
- Is the new knowledge valid and useful?

11.6 Contribution to knowledge and originality of the research

The principal deliverables of the research were:

1. A robust definition of remanufacturing.
2. A flow chart of the generic remanufacturing operation.
3. A comprehensive generic model of the remanufacturing business process.

The originality of the research lies in the fact that the literature indicates that it is the first time that:

1. Remanufacturing has been analysed from a business process perspective. This is because up to this point it has only been examined from an engineering design and ecological viewpoint. The results of this research allows it to be recognised as a unique business process with great economic significance, and with problems that require specific solutions.
2. A robust and unambiguous definition of remanufacturing has been determined, which for the first time allows that process to be differentiated from repair and reconditioning, and thereby help to alleviate confusion between secondary market operations.
3. A comprehensive model of the generic remanufacturing business process has been developed. This allows remanufacturing knowledge to be explicitly disseminated; it is also an analytical tool that can be applied to resolve problems that are unique to the remanufacturing environment.
4. A standard flowchart for the remanufacturing operation has been determined.
5. The research has determined that there are two standard remanufacturing flowcharts. One for remanufacturers that have contracts and another for independent remanufacturers (those without contracts).

6. The “investigate core” sub process has been identified as a critical element of the remanufacturing process.
7. The processes of assessing the suitability of components for reuse, the “assess component” activity has been identified as the complicating factor in core investigation.

11.7 Beneficiaries

The main beneficiaries of the research are industry and academia.

- **Benefit to academia**

Mellissen and Schippers (1999) have stated that the confusion in the definition of secondary market processes makes it difficult for researchers to undertake research and disseminate their findings. The unambiguous definition of remanufacturing developed through this research would help to resolve this problem because it would permit remanufacturing to be conclusively differentiated from related secondary market processes for the first time. This development would help to improve the effectiveness of the dissemination of remanufacturing knowledge. It would also help to pave the way for productive research into remanufacturing operations so that appropriate tools and techniques can be developed specifically for them.

Guide and Gupta (1999) have stated that there is a paucity of analytic models of remanufacturing. The generic model can help to address this problem because it can be used to analyse the remanufacturing operation and other sub processes of the remanufacturing business process so that they can be understood and improved if required.

- **Benefit to industry**

In the case of industry the comprehensive generic model of the remanufacturing business process concisely and logically displays the resource required in all areas of the remanufacturing business process and as a result may be used as a tool for planning and controlling remanufacturing operations. The key advantage is that it could be used to help to design and implement effective and efficient remanufacturing operations businesses, as well as to improve existing remanufacturing ones.

11.8 Research methodology

The main research tools were literature search and the qualitative research method of case study analysis. Eisenhardt's case study approach (1998) was used to structure the research because it is a powerful user-based methodology that could guide the research to ensure that its output satisfied the needs of the practitioner. The research design and the structuring of the research were explained in detail in chapter 3.

11.9 Areas of further research

The research has identified four aspects of remanufacturing that require further analysis and these are described in the following paragraphs.

11.9.1 Use of the research findings to develop additional remanufacturing-specific tools

Following the research it is expected that the error-reduction guidelines will be used to develop tools and techniques, including software-based tools, which will enable remanufacturers to improve the efficiency and effectiveness of their operations.

11.9.2 Research to facilitate contracts between OEMs and remanufacturers

The research has shown that the most successful remanufacturers are those that have contracts. The case studies detailed in chapters 4 and 6 have illustrated the many advantages that contracts offer. For example, typically, contract remanufacturers are large, have national or international status and can afford expensive in-house developed tools and techniques. This can be taken as an indication of their wealth and therefore their success. Independent practitioners on the other hand are small regional operations that typically cannot afford to develop these tools and techniques. This can be taken as an indicator of their comparatively modest income.

From the validated generic model presented in Appendix 8, and case study evidence, it can be seen that core supply is an important constraint in remanufacturing operations. This evidence indicates that one of the main reasons for the relative wealth of contract remanufacturers in comparison to independent practitioners is that contract remanufacturers have a ready supply of cores. In other words it is not the contract in itself that helps to increase the wealth of a remanufacturer, but the supply of usable cores that the contract brings. This is because the remanufacturing operation cannot begin without a used product to rebuild. Therefore, a remanufacturer may have abundant contracts, but if it obtains no cores then the business is unlikely to grow. In fact, contracts bring additional benefits that help to enhance remanufacturers' profitability. These include access to product design information from the OEM, as well as a ready market because core suppliers are also often customers. In the case of product design information, the case studies described in chapters 4, 5 and 6, and indicated in table 4.2, showed that independent remanufacturers face many difficulties because of Intellectual Property Rights restrictions (IPR).

From the above discussion it can be seen that remanufacturers would benefit from new research to establish methods that facilitate contracts between OEMs and remanufacturers. This development would benefit remanufacturers because they would have access to the cores, and design information, that they need to undertake effective remanufacturing. It may also reduce their operational costs because it would limit the need for reverse engineering. OEM companies may also benefit from this research as it provides them with some control over products bearing their brand name. It also permits them to obtain product failure information that can assist product design improvements.

11.9.3 Research to encourage the adoption of the new definition

This research has obtained new knowledge in the form of a new robust definition of remanufacturing. This research has also shown that academia and industry would both benefit from new research to identify methods that can be used to assist rapid and unanimous adoption of the new definition. This is because such a development would help to resolve the problems caused by the confusion in the definitions of secondary market operations.

11.9.4 Research to use the new knowledge

The research has also developed a generic model of the remanufacturing business process. From the research findings it can be seen that practitioners would benefit from new research to document the model's effectiveness when used as a reference model in an actual remanufacturing operation.

11.10 Limitations of the research

The research had limitations related to the population of remanufacturing practitioners consulted during the case studies as well as the number of practitioners and academics involved in the validation of the research findings.

- The number of case study companies

Because of the difficulties involved in identifying remanufacturers, described in Chapter 3, a limited number of remanufacturing companies were consulted in this research. However, one of the difficulties associated with qualitative research is dealing effectively with the great amount of information that it yields. As only one person undertook this research and time and resource were key constraints, involving a greater number of practitioners would have resulted in information overload. However, it is possible that the research findings could be scrutinised in greater detail by undertaking further analysis of remanufacturing using a greater number of researchers and case study companies. The outcome of the new research could be compared to those of this research to identify and explain any dissimilarity and if possible to augment the information obtained from this research.

- The number of practitioners involved in the validation.

The number of practitioners that assessed the validity of the research findings was fairly limited. Because these expert users believed the research findings were sufficient and useful, there is good indication that a wider range of practitioners would also hold that opinion. However, the research could benefit from further assessment by a greater number of practitioners. This would help to assess whether the limitation in the number of validation panel had influenced the research outcomes.

11.11 Summary

This chapter has summarised the research and its findings. It has explained the economic significance of remanufacturing in terms of its ability to obtain profits for the practitioner. It has stated that the rationale for the research was the need to determine new knowledge that addressed problems such as the scarcity of remanufacturing-specific tools and the paucity of remanufacturing knowledge. It has explained that the research has seven angles of originality. For example, the literature indicates that this represents the first instance where remanufacturing has been analysed from a business process perspective. In addition, the literature indicates that it is the first time that a robust and unambiguous definition of remanufacturing has been obtained. The literature also indicates that this is the first instance where a generic model of the remanufacturing business has been developed. It has stated that the key deliverables of the research were a robust definition of remanufacturing and a comprehensive generic model of the remanufacturing business process. It has explained that the main beneficiaries of the research are industry and academia because the research has addressed key problems that they face, for example, the ambiguity of remanufacturing definitions. Four opportunities for further remanufacturing research have been identified. These are; using the research results as a basis for developing additional remanufacturing specific tools, determining methods to encourage the establishment of contracts between OEM and remanufacturing practitioners, developing methods to assist the universal adoption of the new definition, and using the generic model as a reference model in a real life remanufacturing operation.

Appendices

1 The company specific model of remanufacturing

BEST COPY

AVAILABLE

Variable print quality

EMMANUEL FACTURE
 PRODUIT

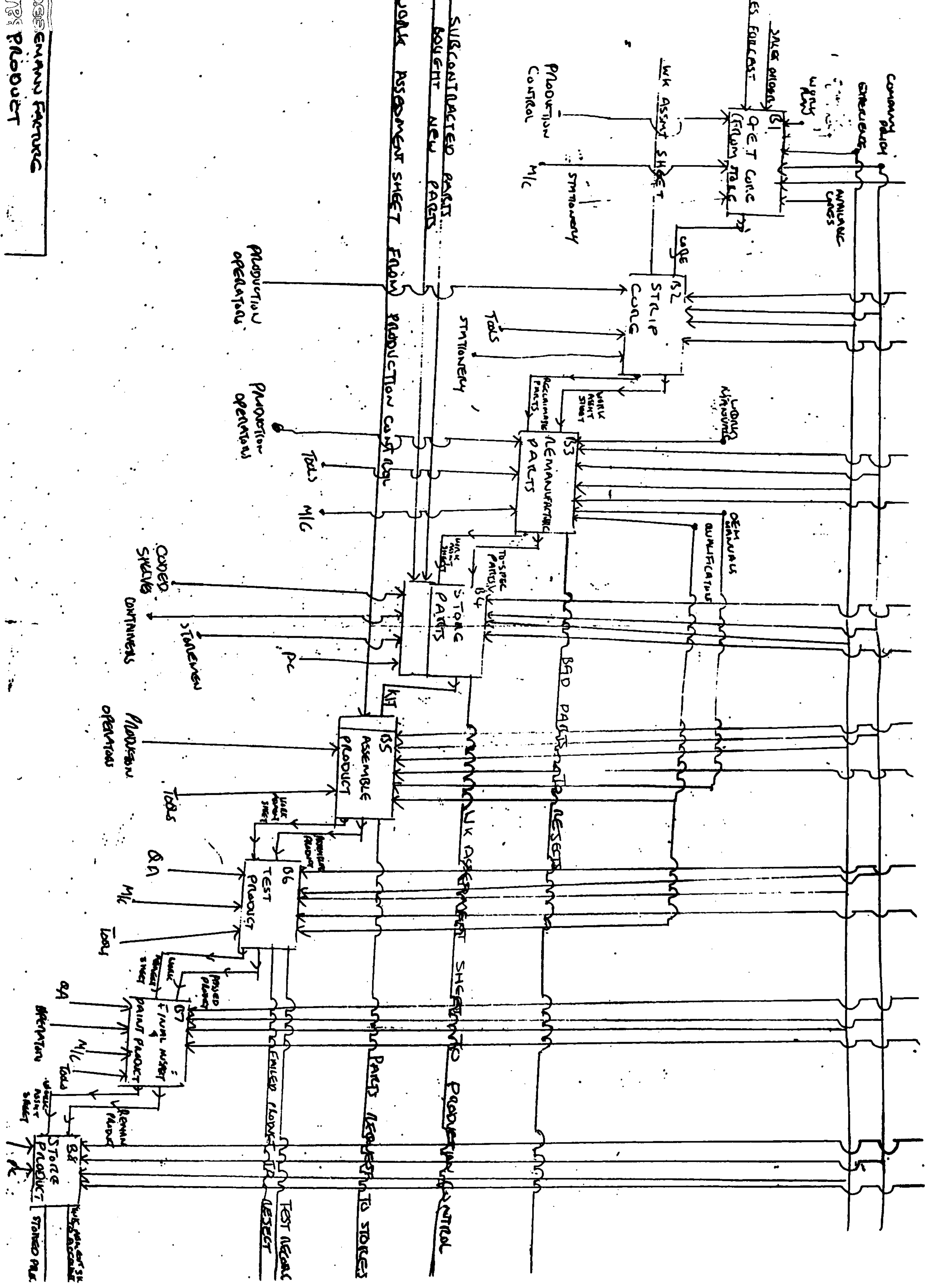

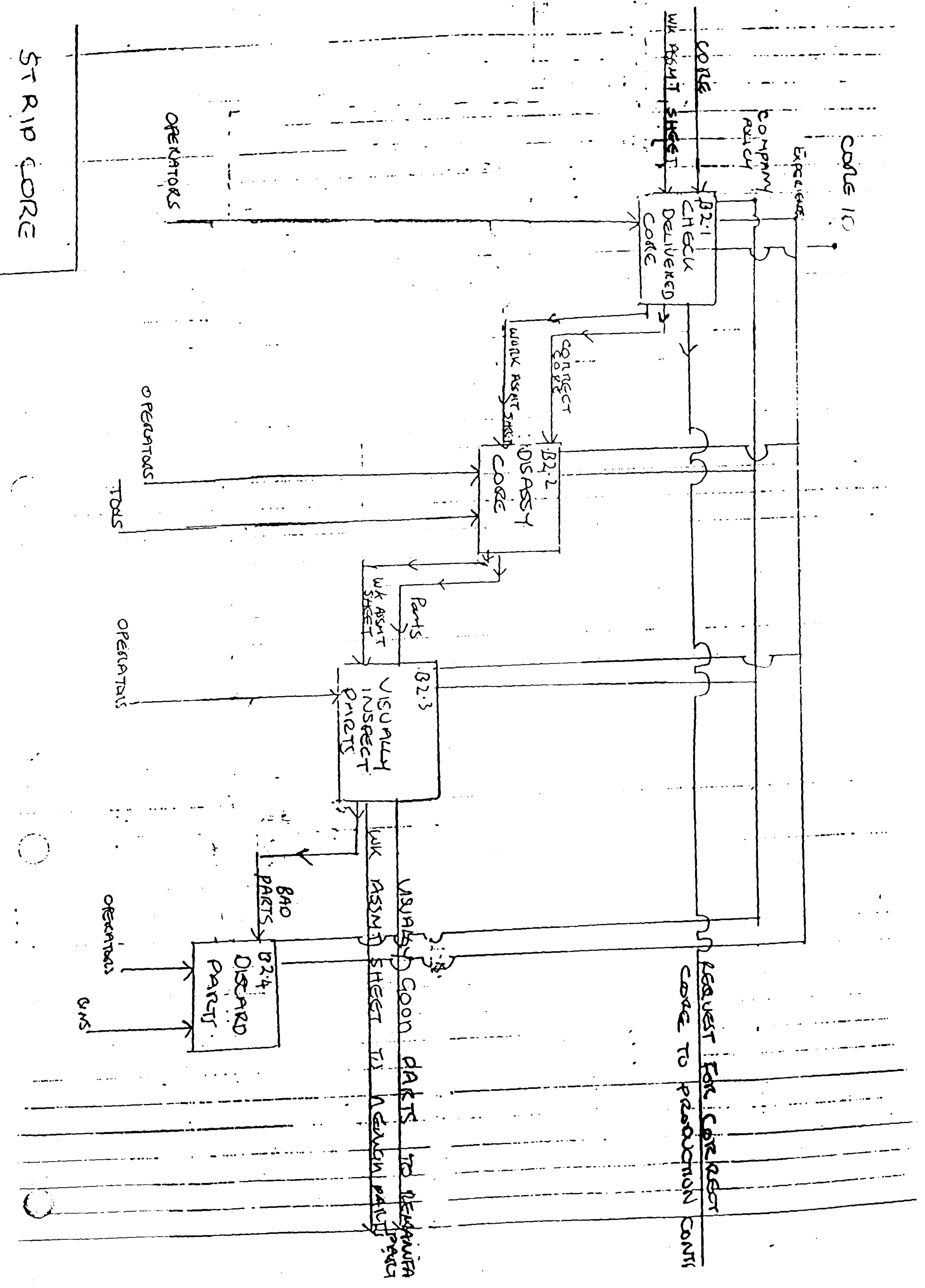

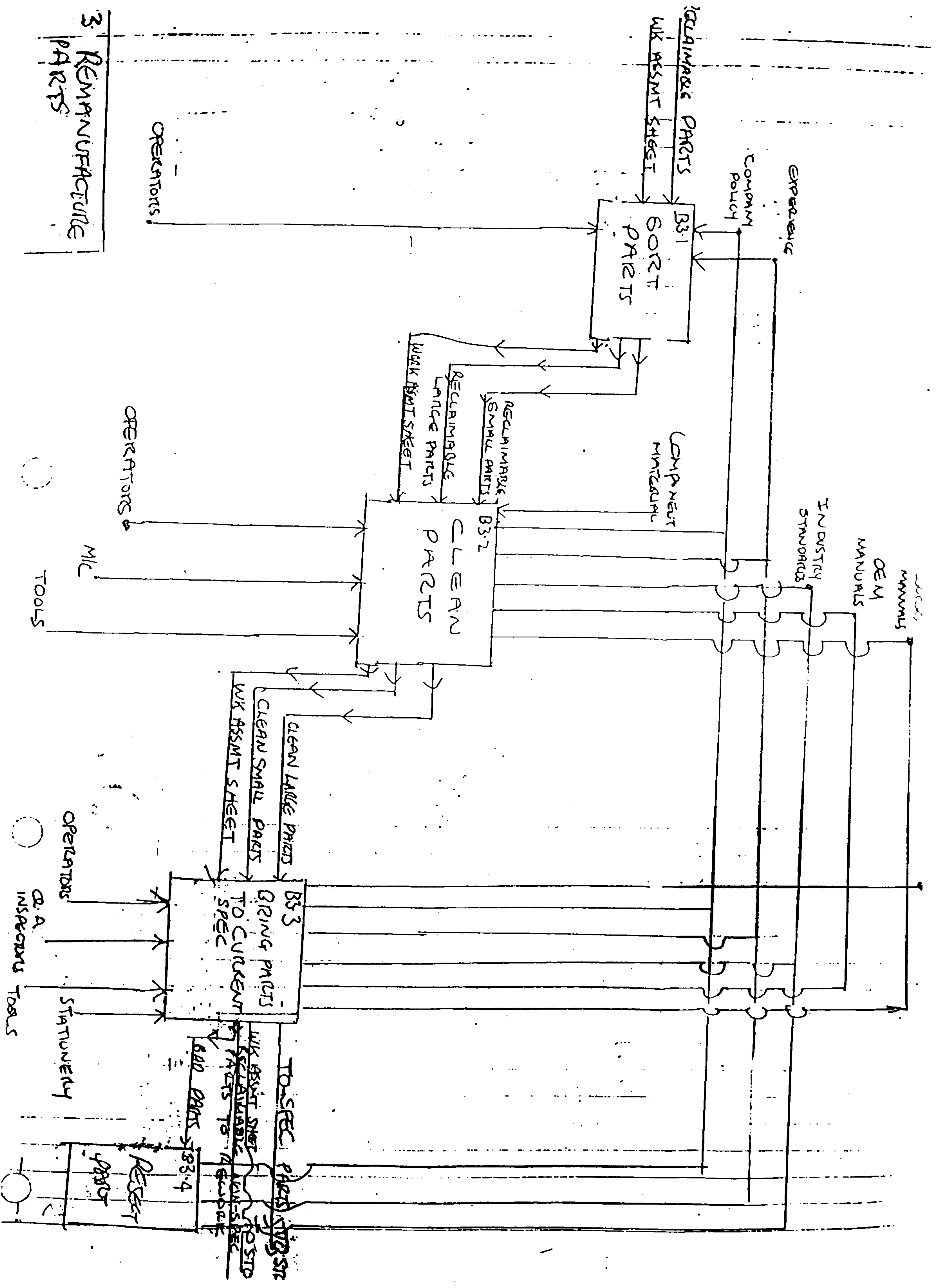

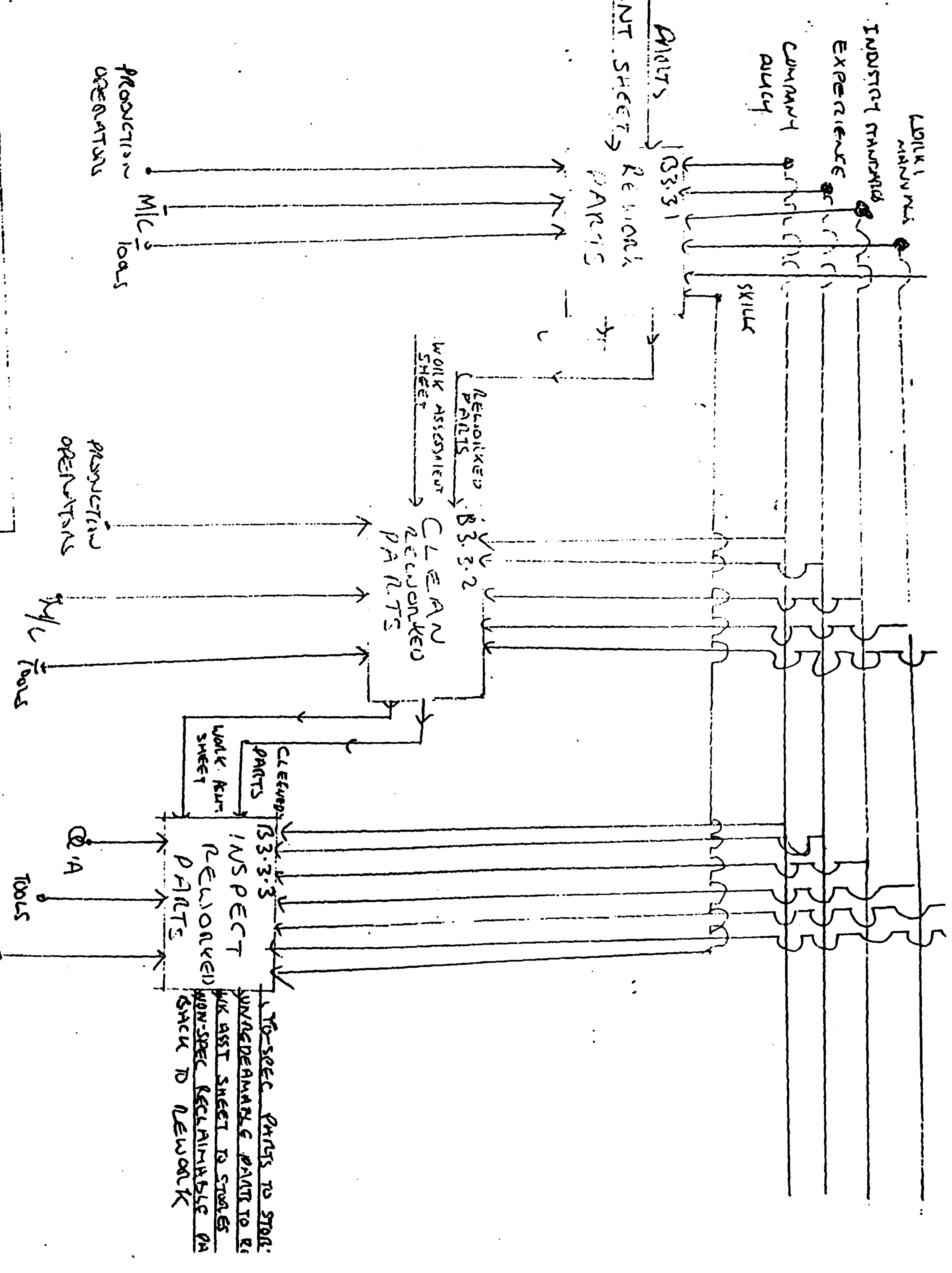

3.3.3 PRING PARTS TO CURRENT SPEC

STANDARD

TO-SPEC PARTS TO STOR.
UNDETERMINABLE PARTS TO RE-ASSIST SHEET TO STAGES
NON-SPEC RECLAIMABLE OR BACK TO NETWORK

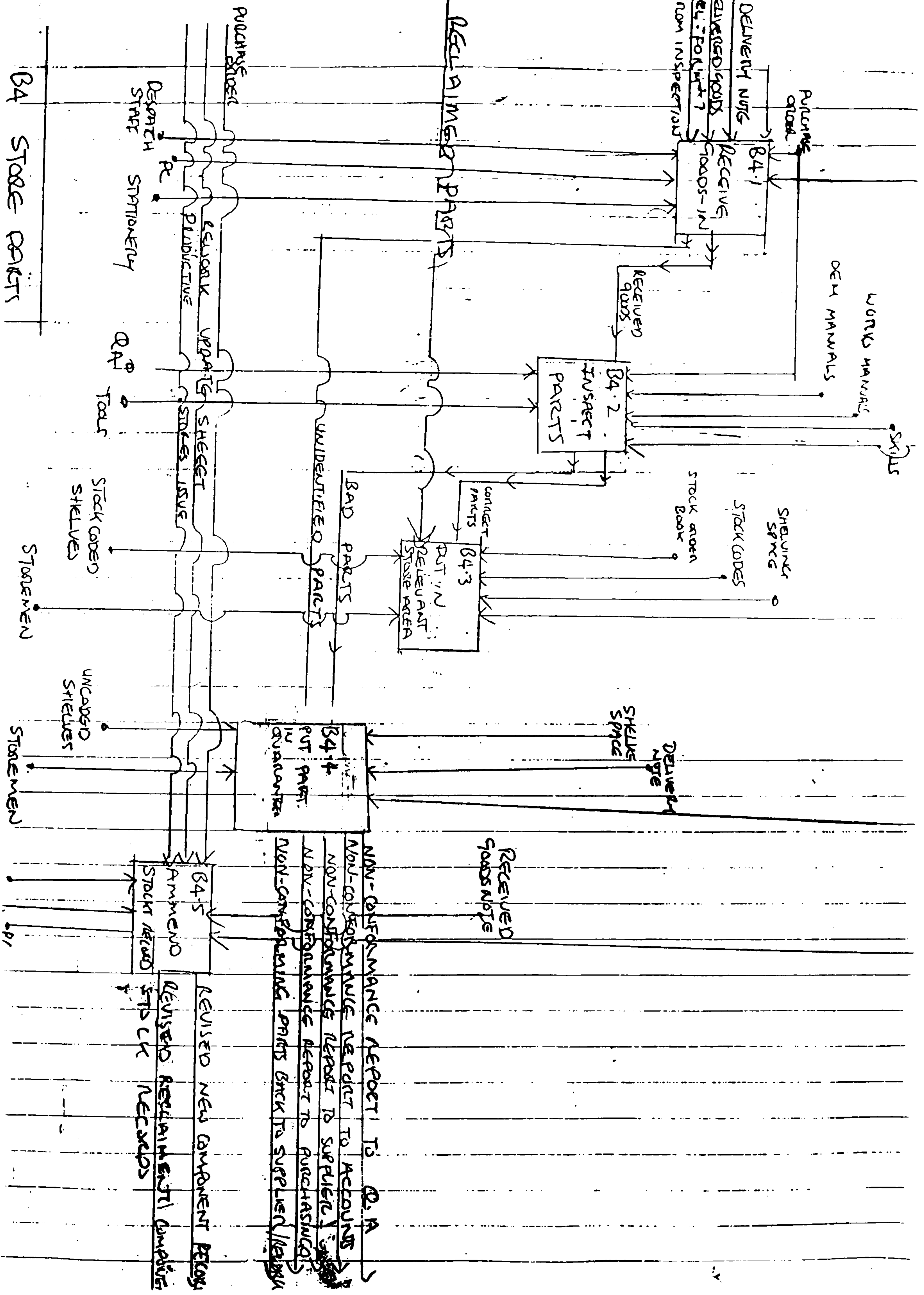

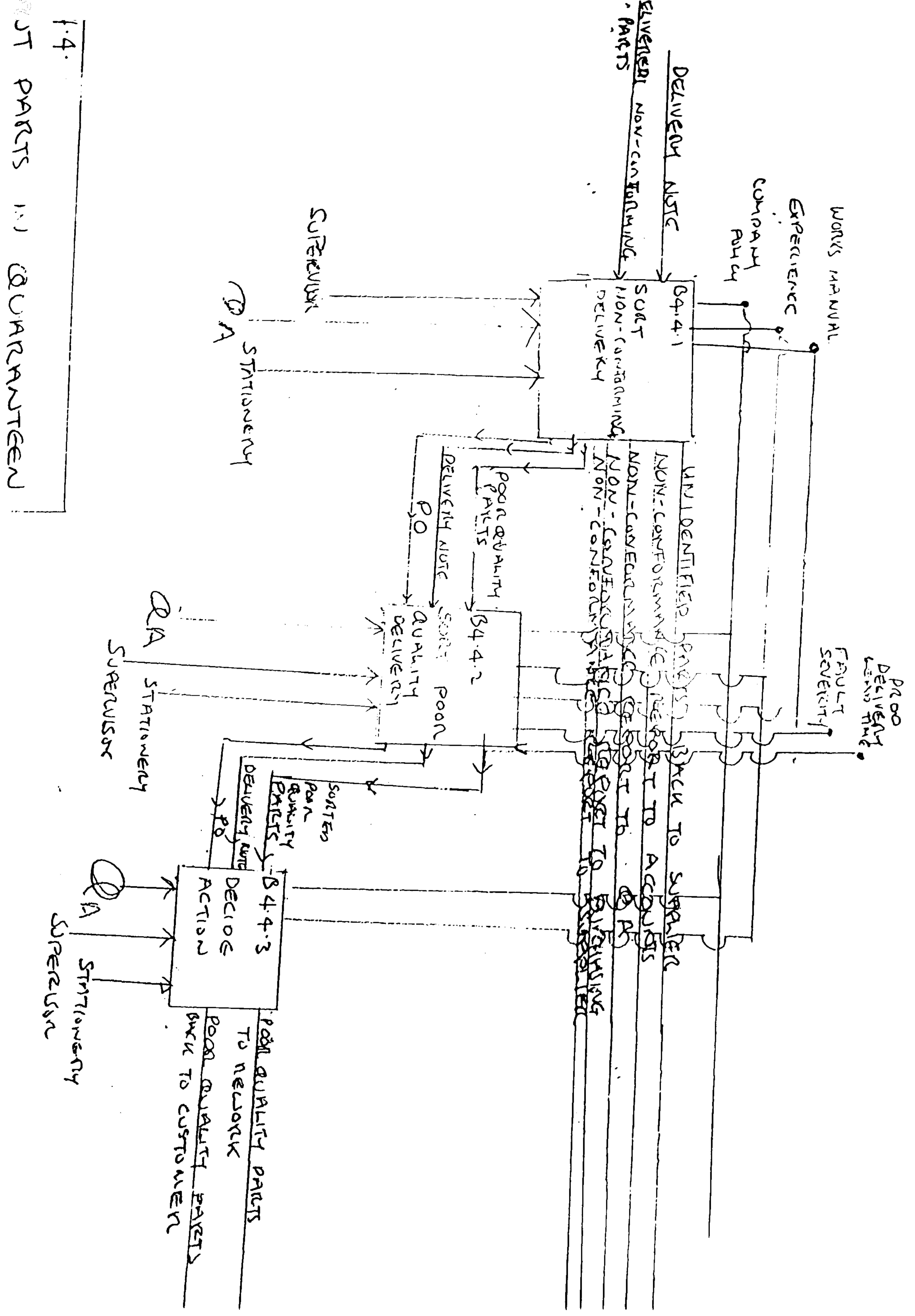

f.4.

JUST PARTS IN GUARANTEEEN

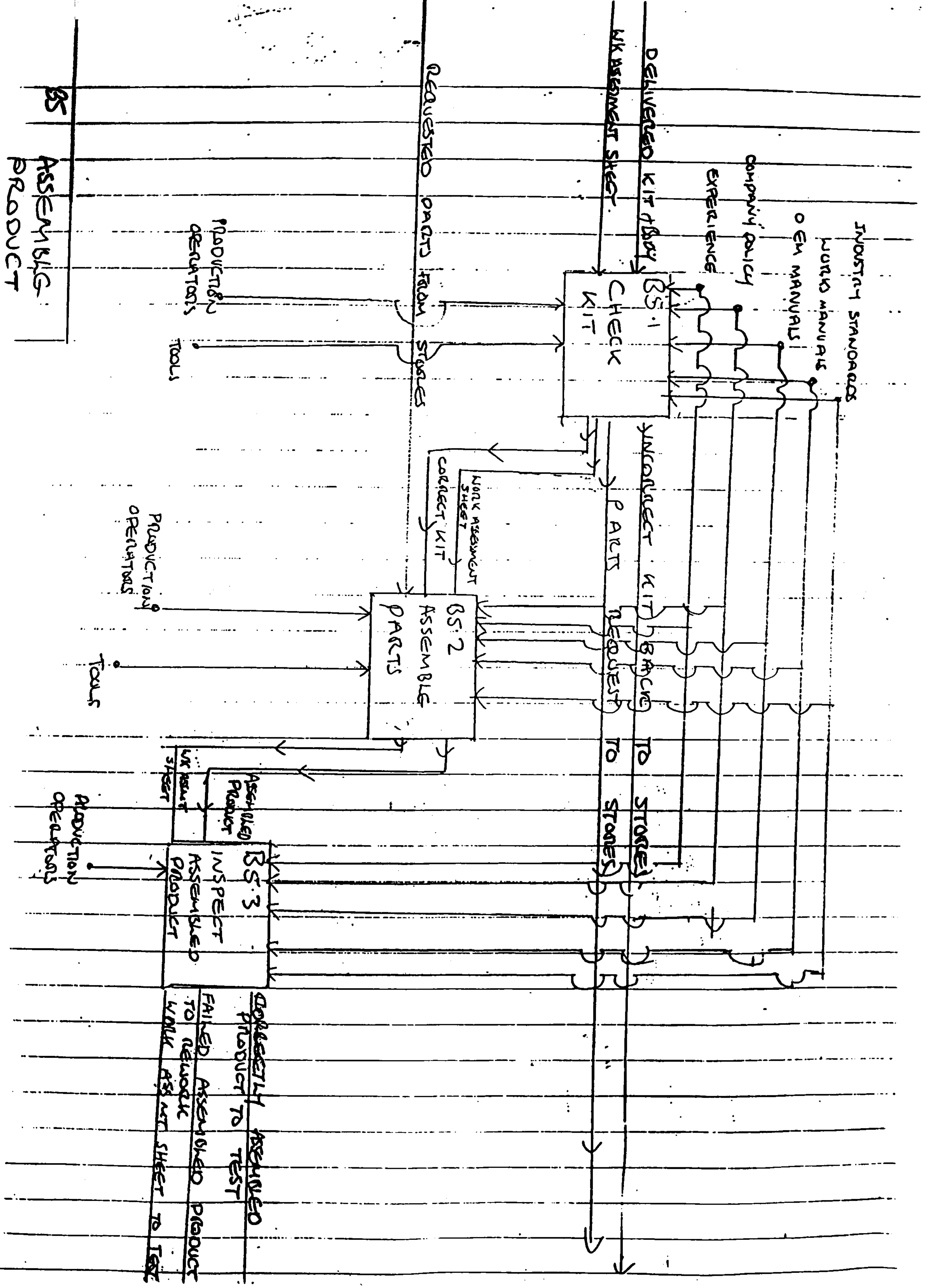

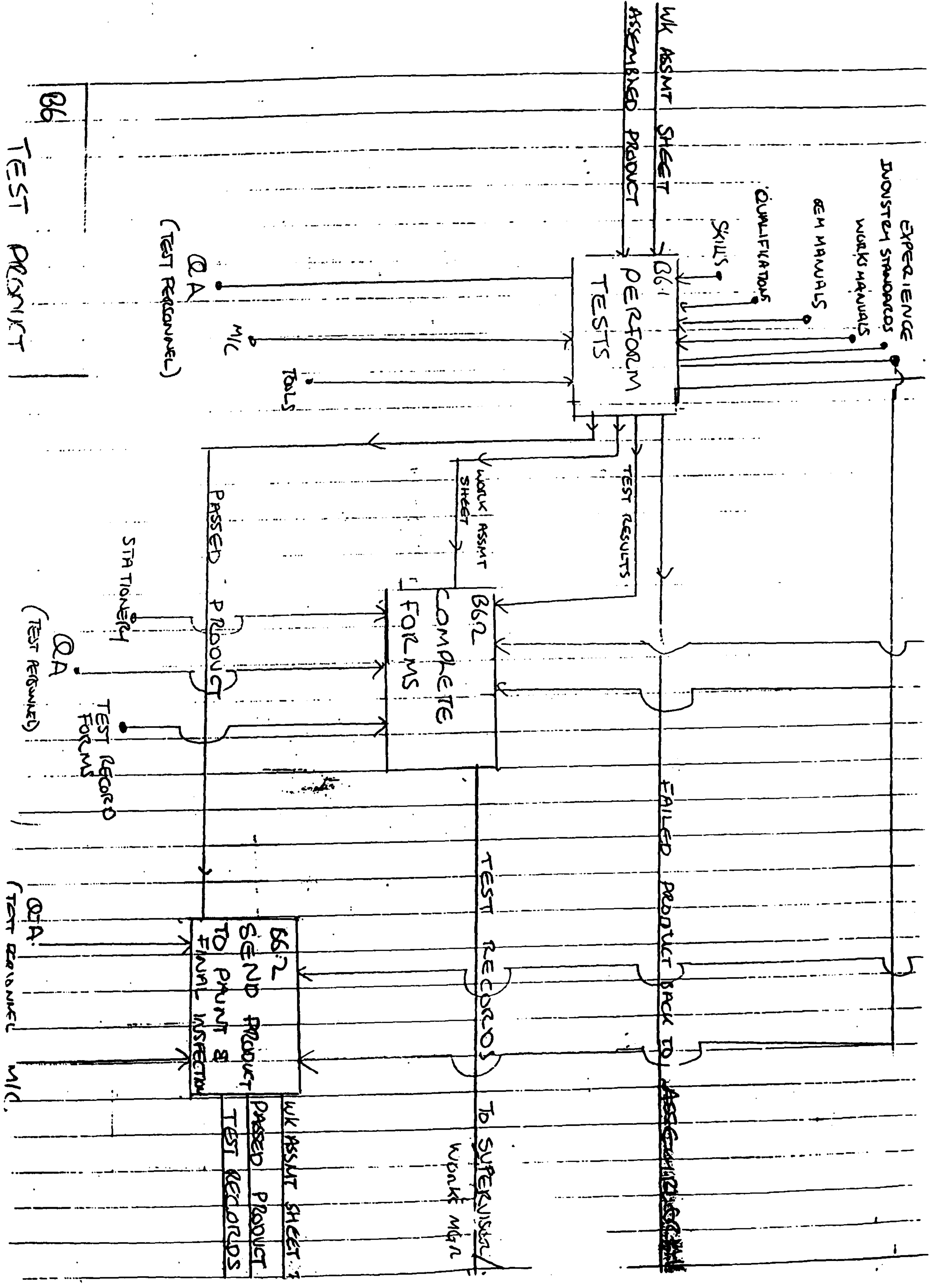

B6 TEST RESULT

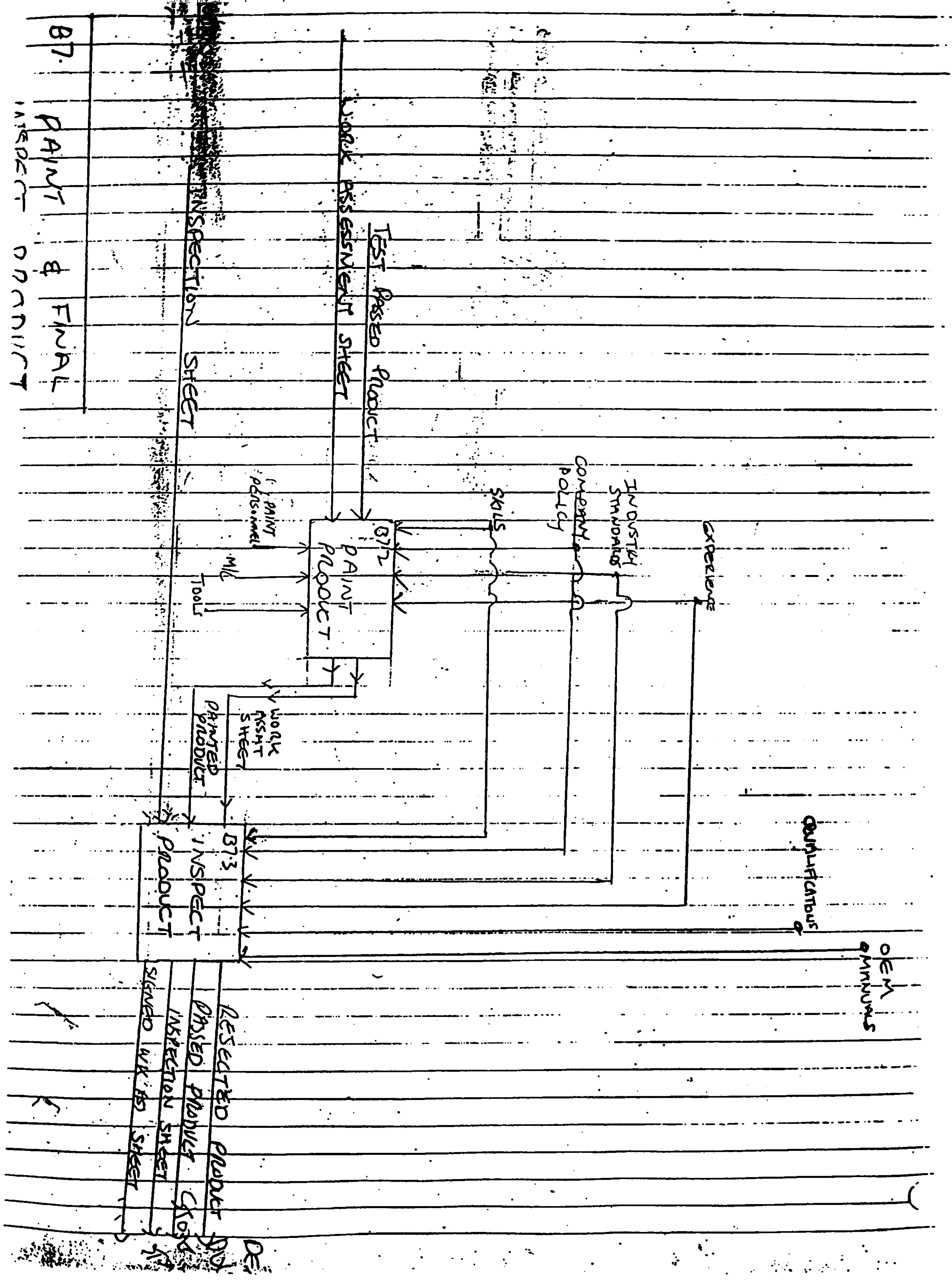

B7.
PAINT & FINAL
INSPECT ORDNMENT

RESELECTED PRODUCT
PRINTED PRODUCT CHECKS
INSPECTION SHEET
SIGNED W.R. AS SHEET

DE

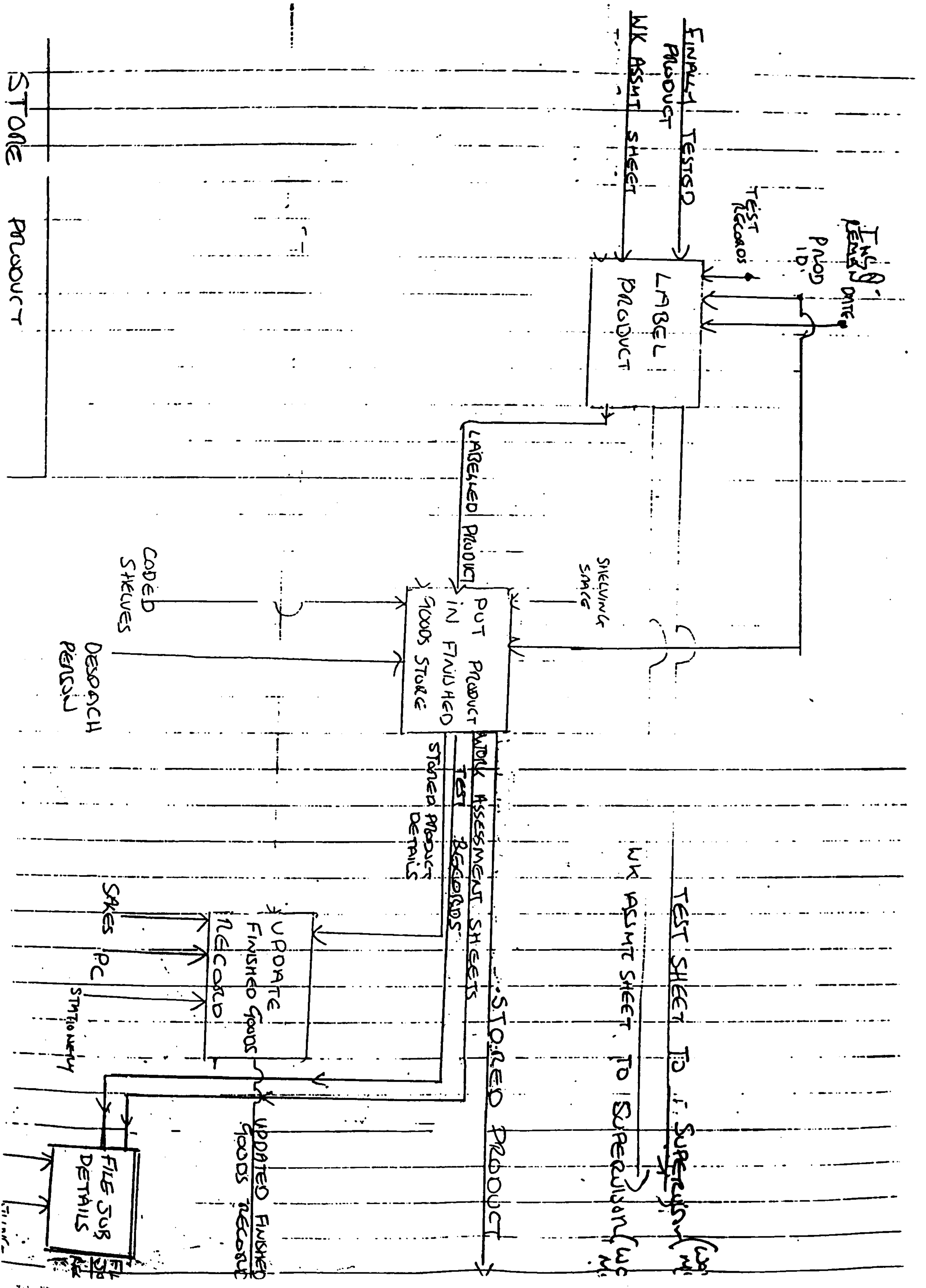

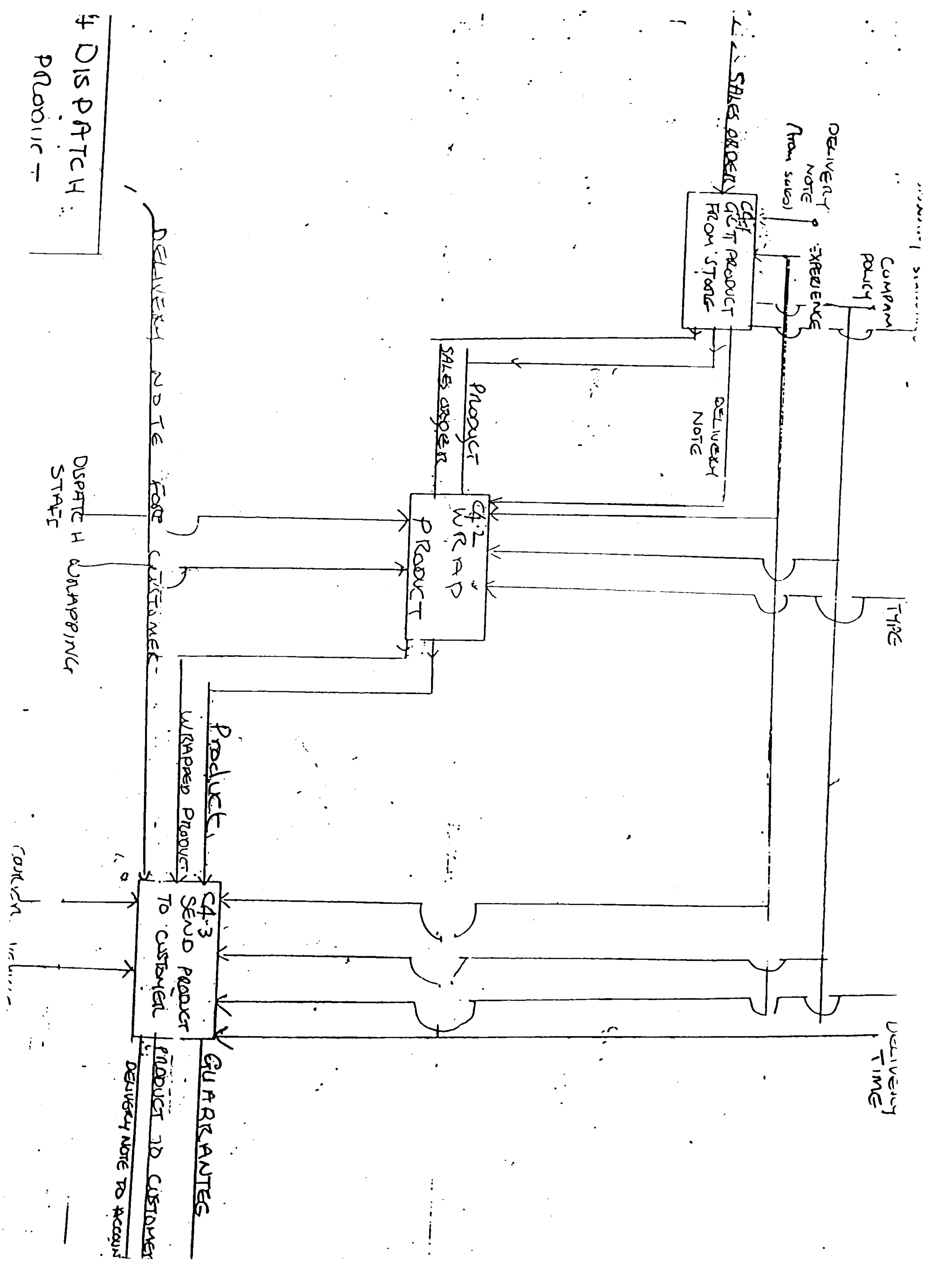

DISPATCH PRODUCT

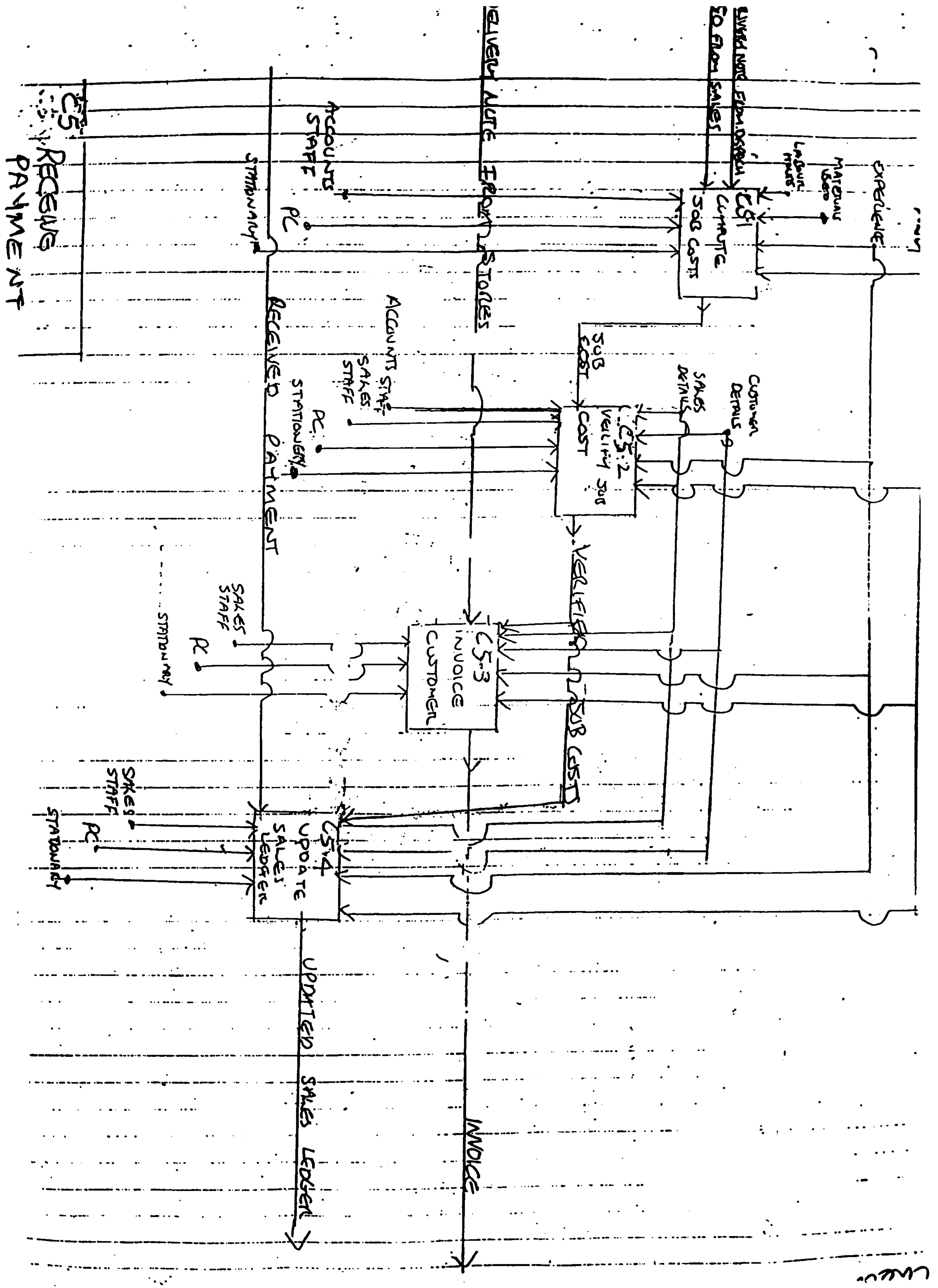

Line

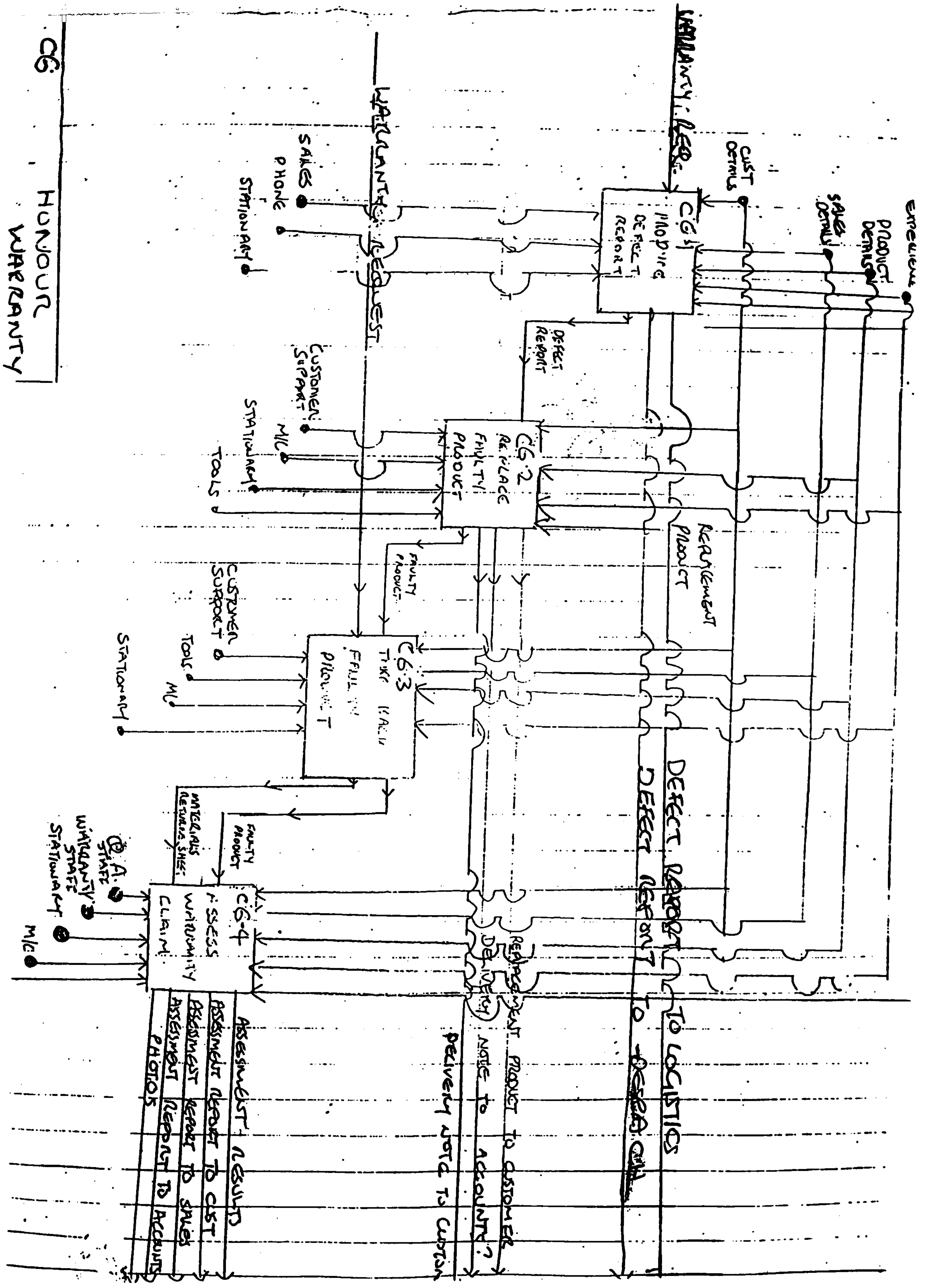

C6 HONOUR WARRANTY

ASSESSMENT REPORT TO SALES
ASSESSMENT REPORT TO CUSTOMER
ASSESSMENT REPORT TO ACCOUNTS
ASSESSMENT REPORT TO PHOTOS

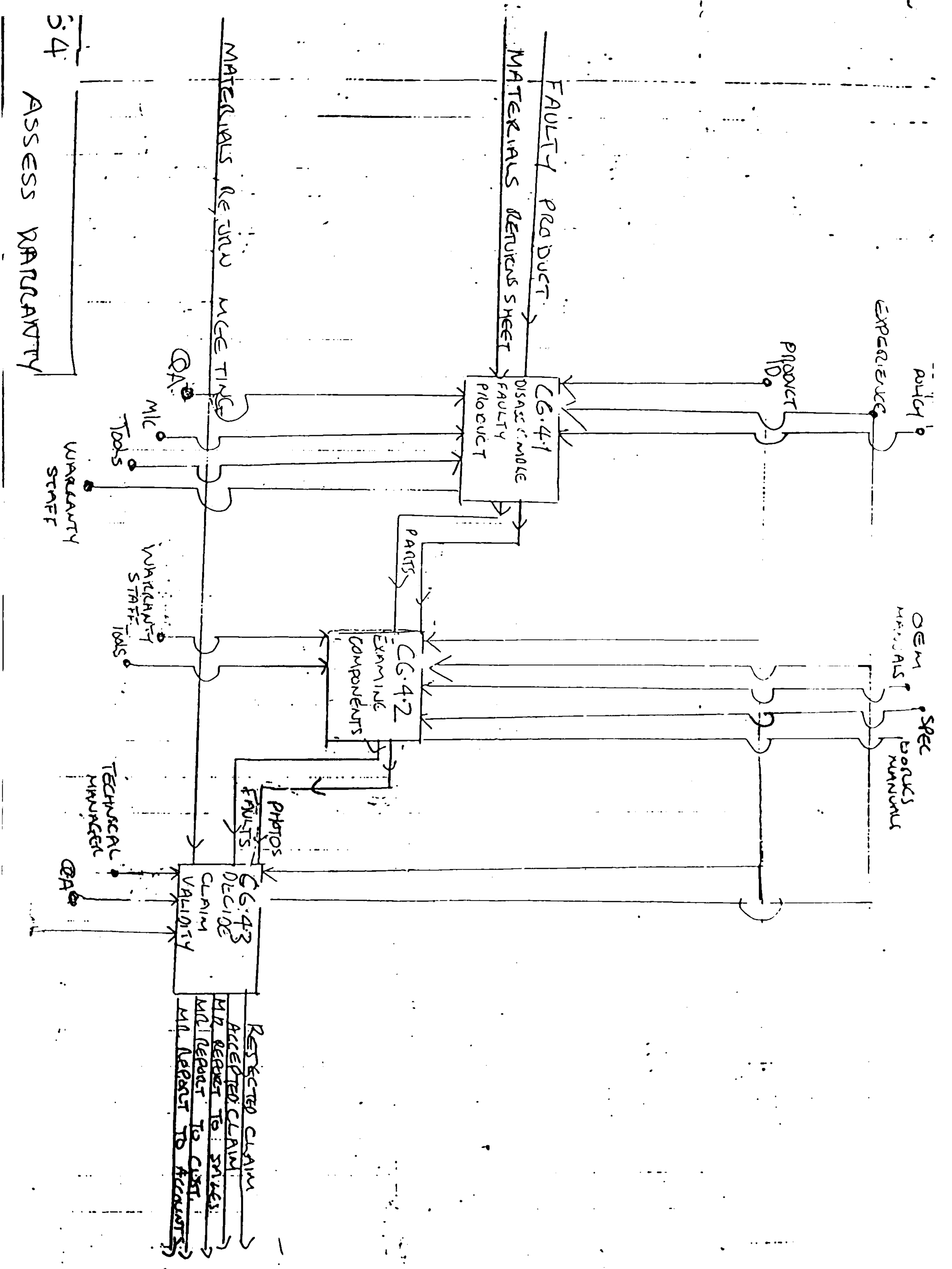

54

ASSESS WARRANTY

MATERIALS RETURN MEETING

FAULTY PRODUCT
MATERIALS RETURN SHEET

CG.4.1
DISASSEMBLE
FAULTY
PRODUCT

CG.4.2
EXAMINE
COMPONENTS

CG.4.3
CLAIM
DECIDE
VALIDITY

REJECTED CLAIM
ACCEPTED CLAIM
MP REPORT TO SALES
ML REPORT TO COST
ML REPORT TO ACCOUNTS

EXPERIENCE
PRODUCT ID

OEM MANUALS
SPEC BOOKS
MANUALS

WARRANTY STAFF

WARRANTY STAFF TOOLS

TECHNICAL MANAGER

QA

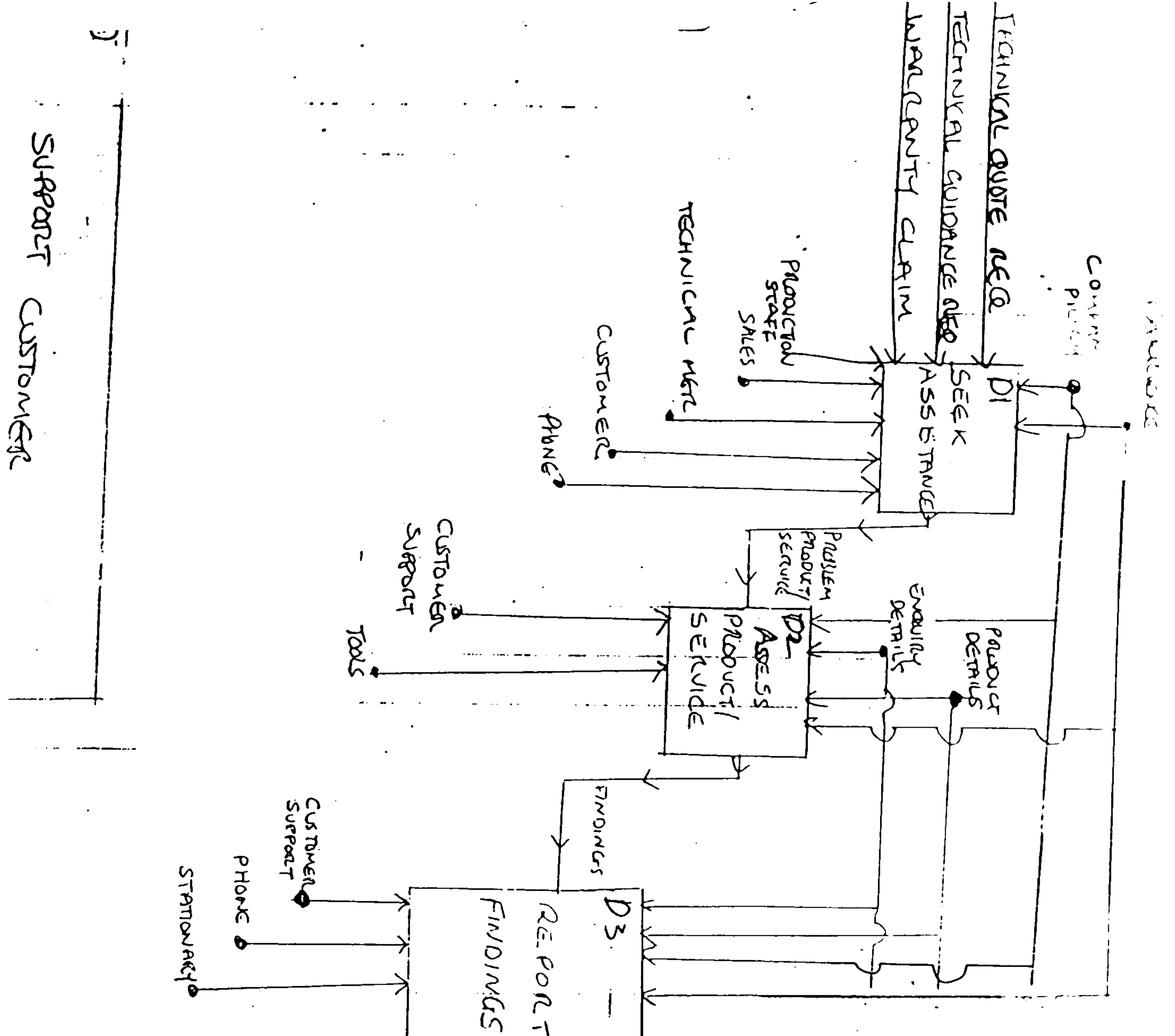

- TECHNICAL ASSISTANCE FOR CUSTOMER
- TECHNICAL GUIDANCE FOR PRODUCTION
- TECHNICAL QUOTATION FOR SALES
- MATERIALS RETURNS REPORT FOR SALES
- SITE VISIT REPORT
- WARRANTY REPORT TO DESPATCH

SUPPORT CUSTOMER

2 IDEF0 information leaflet

IDEFO background

- US military system analysis tool
- Developed during the 1970's
- Part of Polaris programme
- Used to model missile development activities
- Modified for business use
- IDEFO, IDEF1.X, IDEF2, IDEF3

IDEFO

- **What activities are required to carry on the business?**
- **What inputs are being transformed into what outputs?**
- **What influences / controls / triggers / regulates / constrains these activities?**
- **What means are needed to perform these activities?**

IDEF Box ICOM

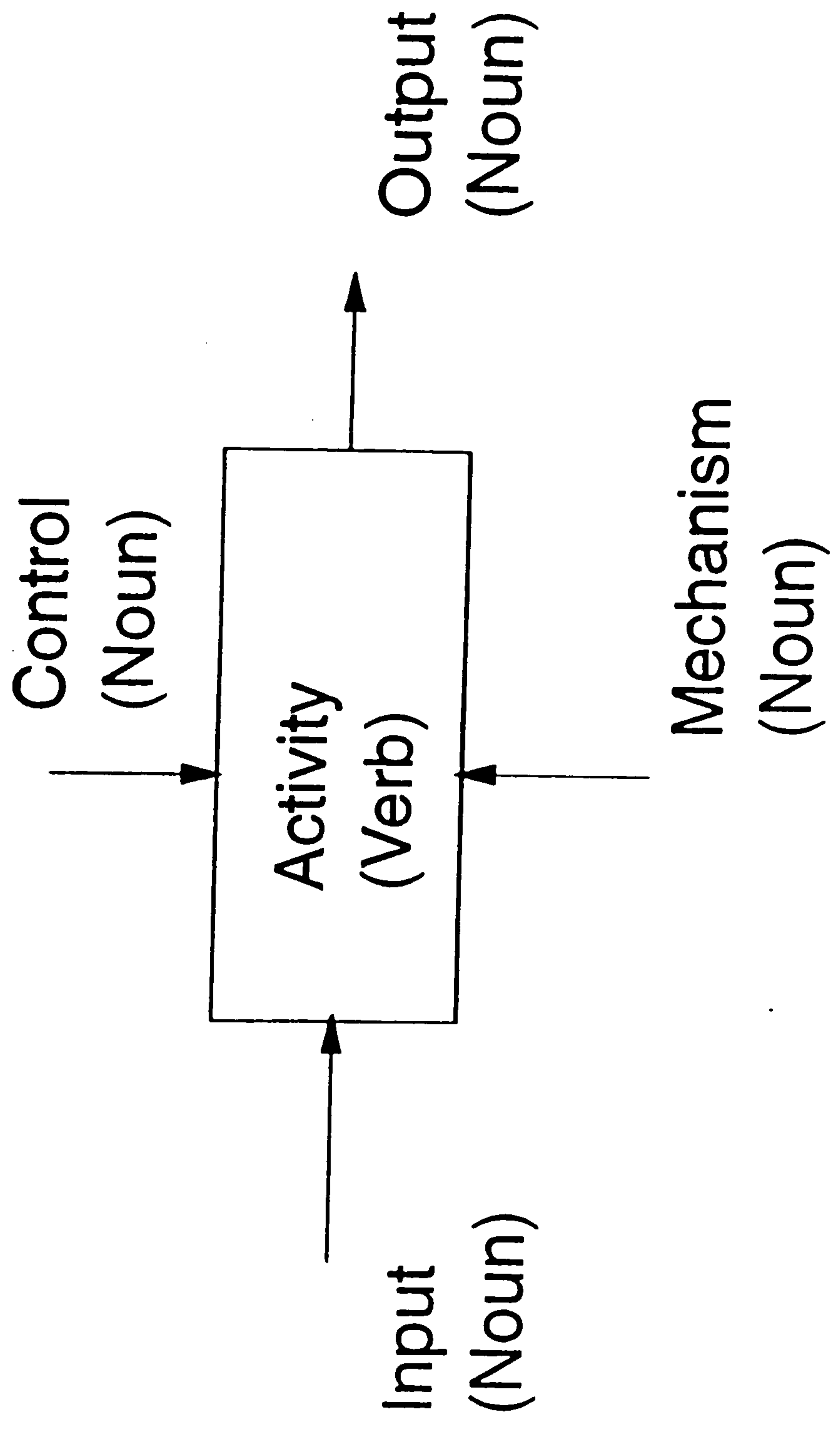

Decomposition

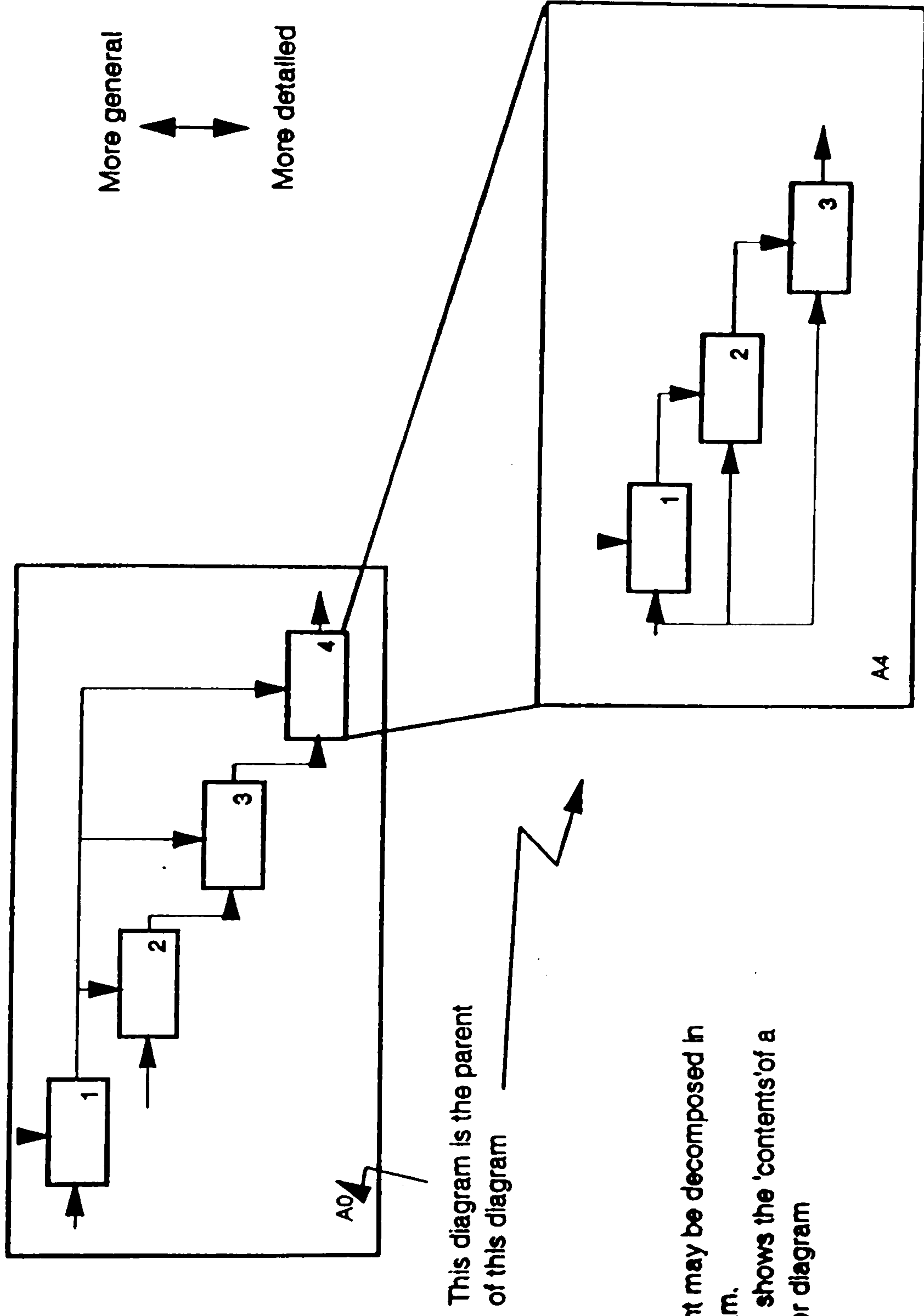

Example of IDEF 0

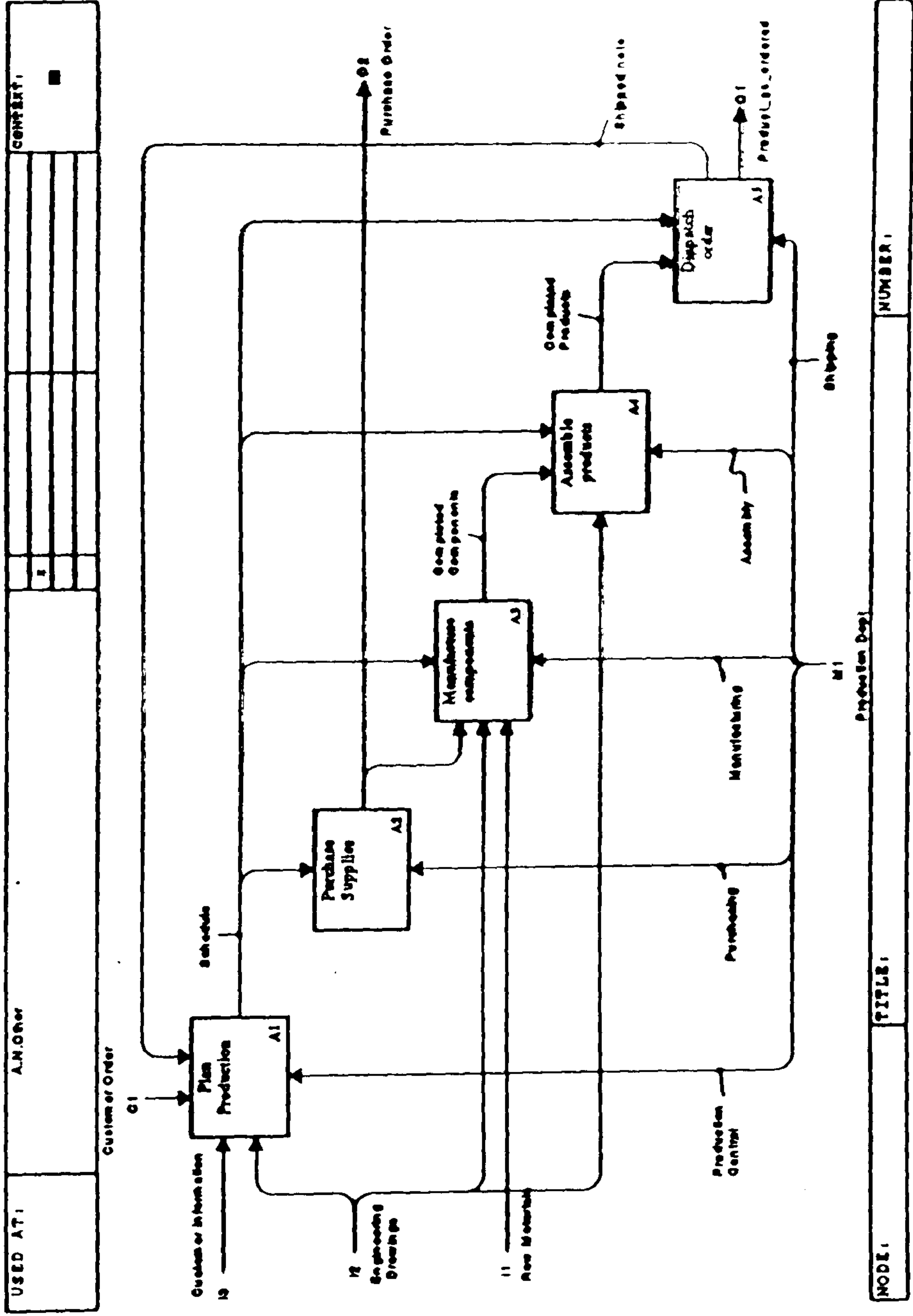

3 The prototype model

00

USED AT:	AUTHOR: Winnie L. Ijomah	DATE: 7/16/00	WORKING	READER	DATE	CONTEXT:
	PROJECT: Decision support guidelines for risk reduction in remanufacturing	REV: 12/6/00	DRAFT			TOP
	NOTES: 1 2 3 4 5 6 7 8 9 10		RECOMMENDED			
			PUBLICATION			

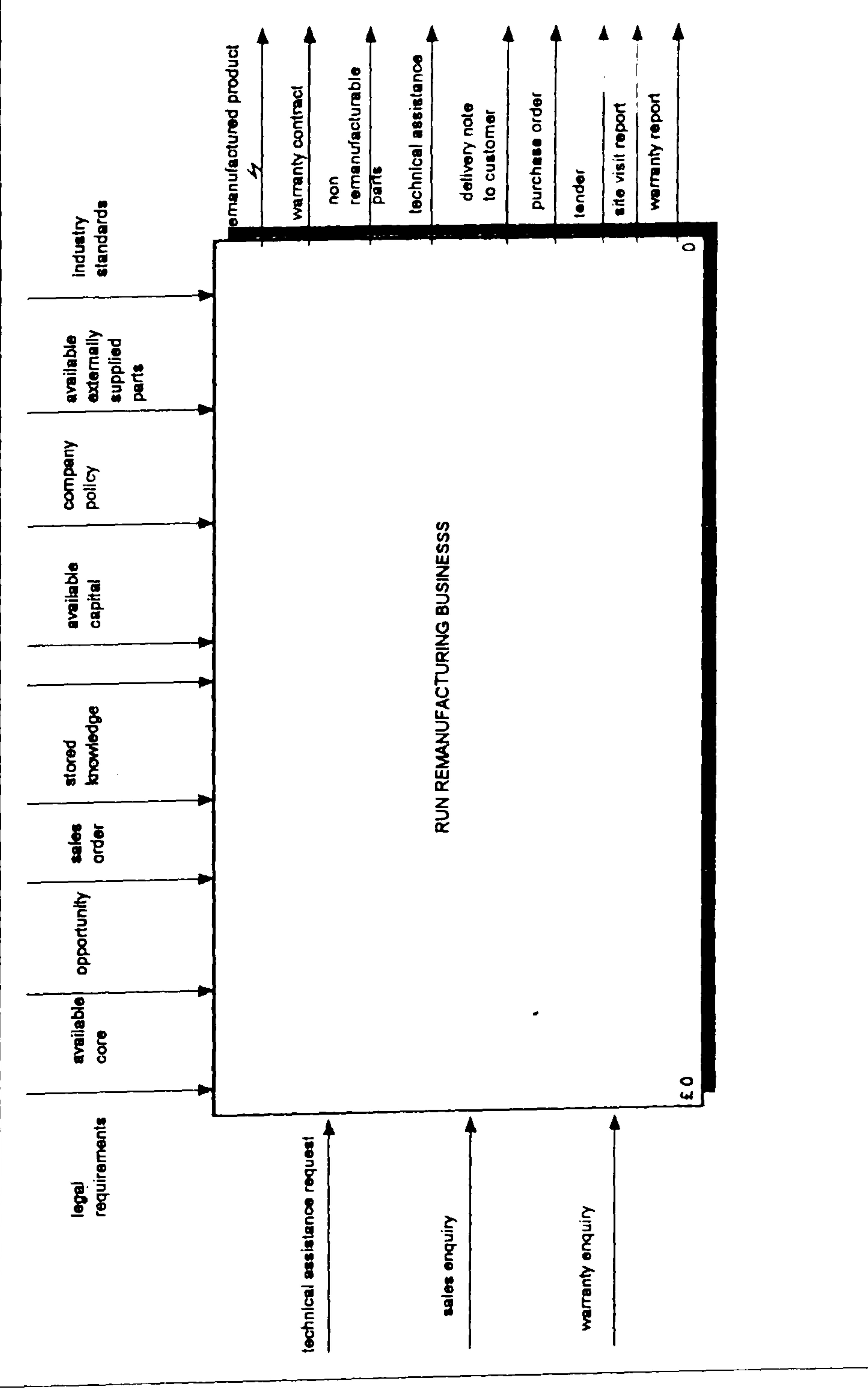

NODE:	TITLE:	NUMBER
A-0	RUN REMANUFACTURING BUSINESS	

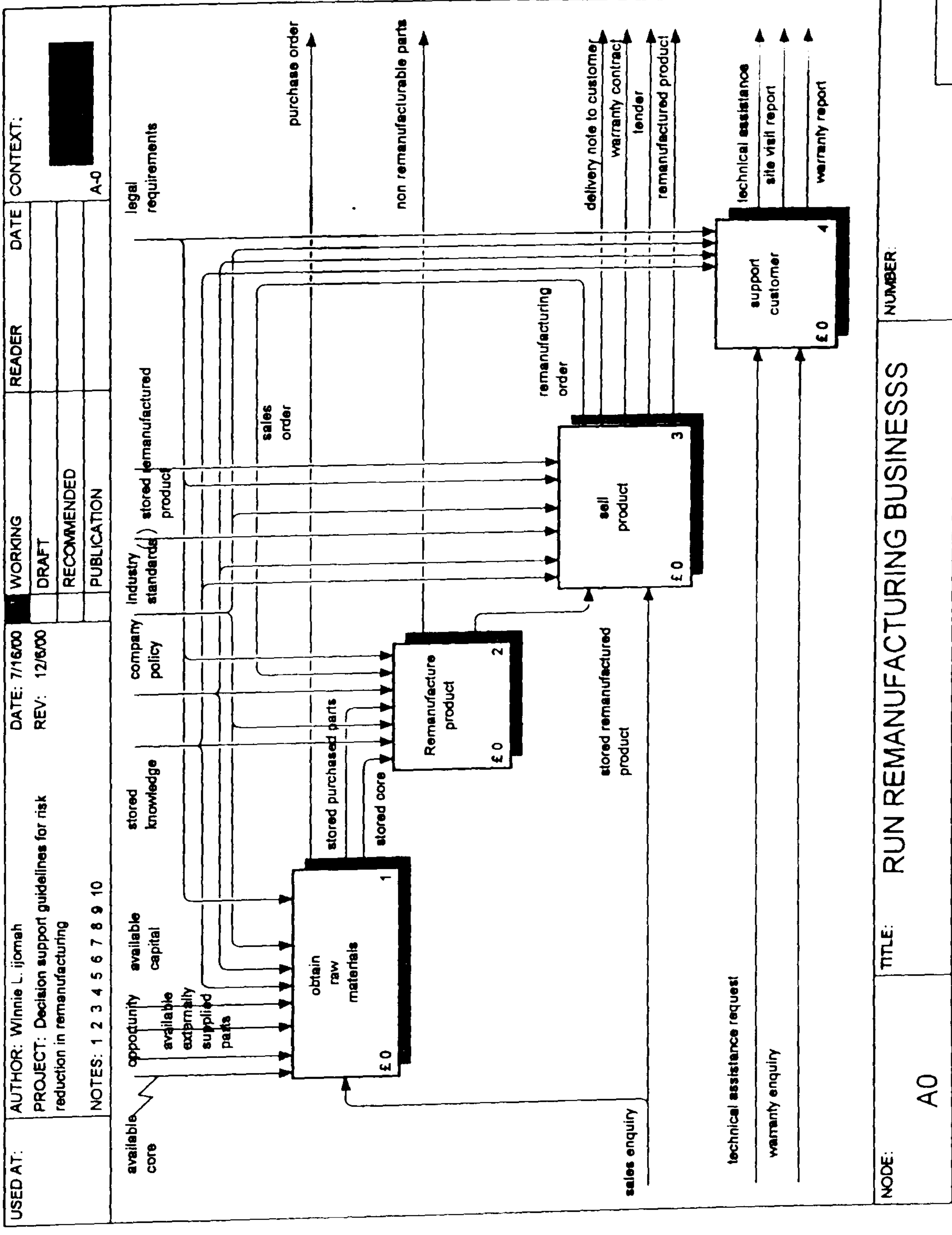

NODE: A0
 TITLE: RUN REMANUFACTURING BUSINESS
 NUMBER:

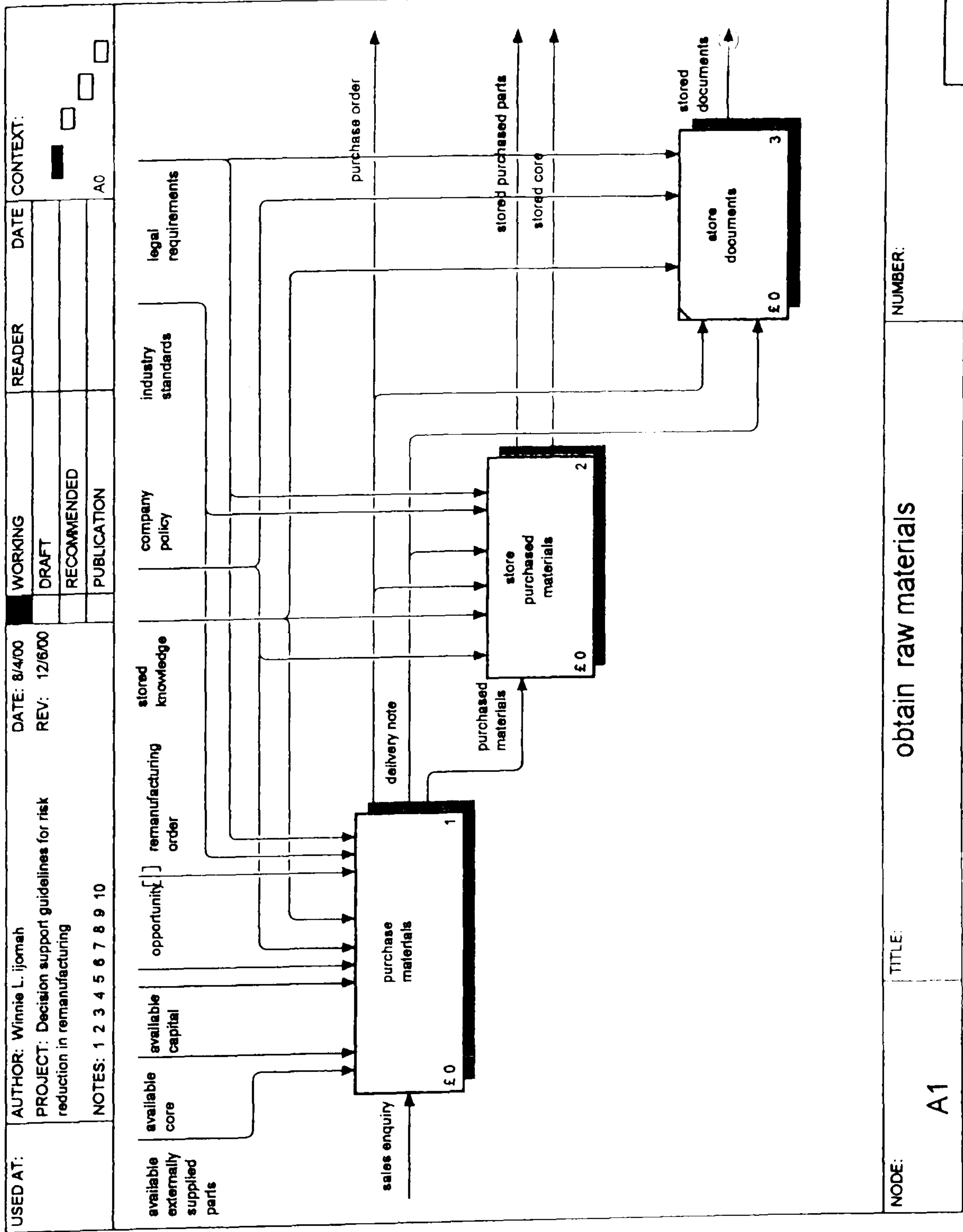

NODE: A1

TITLE: obtain raw materials

NUMBER:



USED AT:	AUTHOR: Winnie L. Ijomah	DATE: 9/8/00	WORKING	READER	DATE	CONTEXT:
	PROJECT: Decision support guidelines for risk reduction in remanufacturing	REV: 12/6/00	DRAFT			
			RECOMMENDED			
	NOTES: 1 2 3 4 5 6 7 8 9 10		PUBLICATION			A1

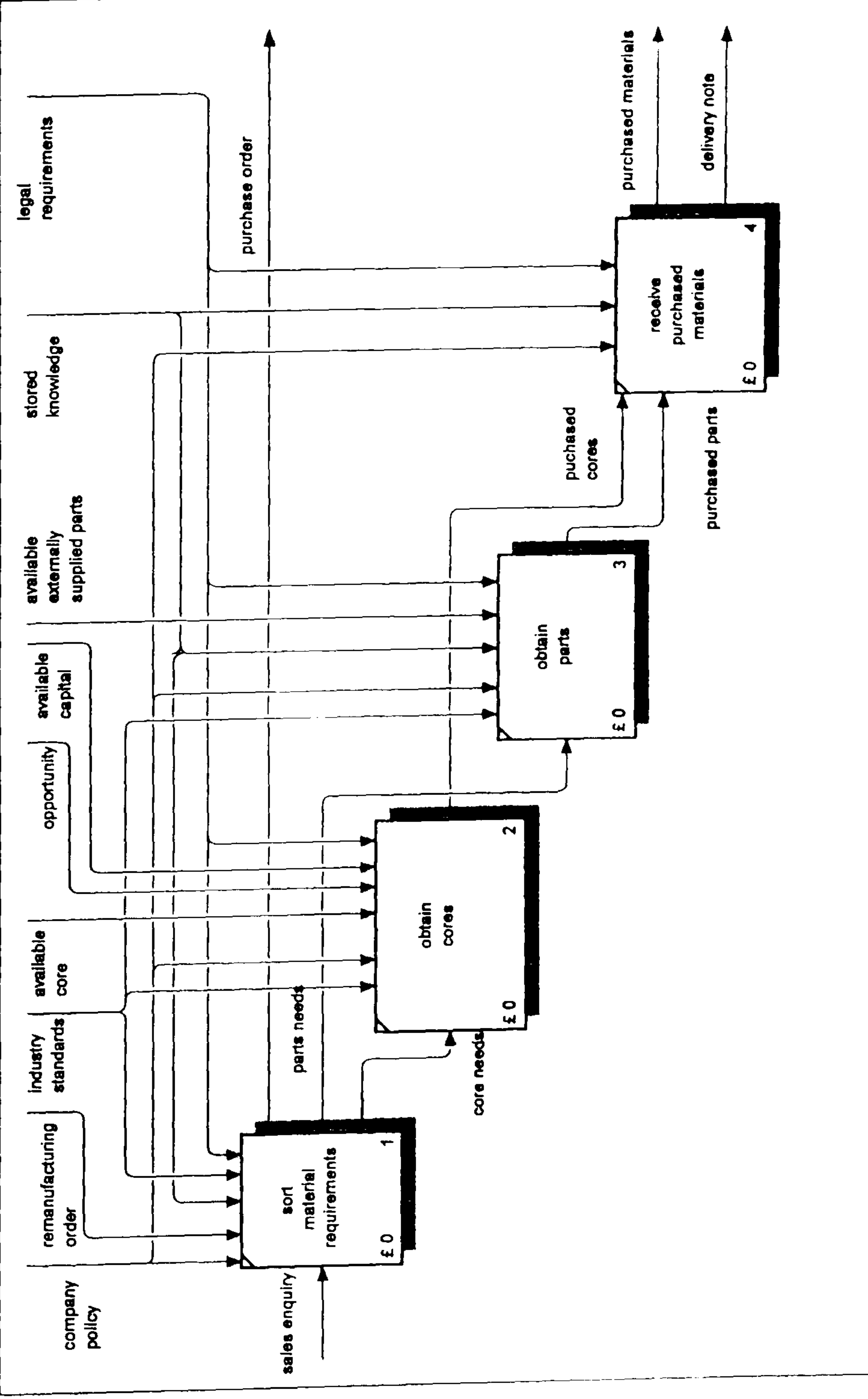

NODE: A11	TITLE: purchase materials	NUMBER:
-----------	---------------------------	---------

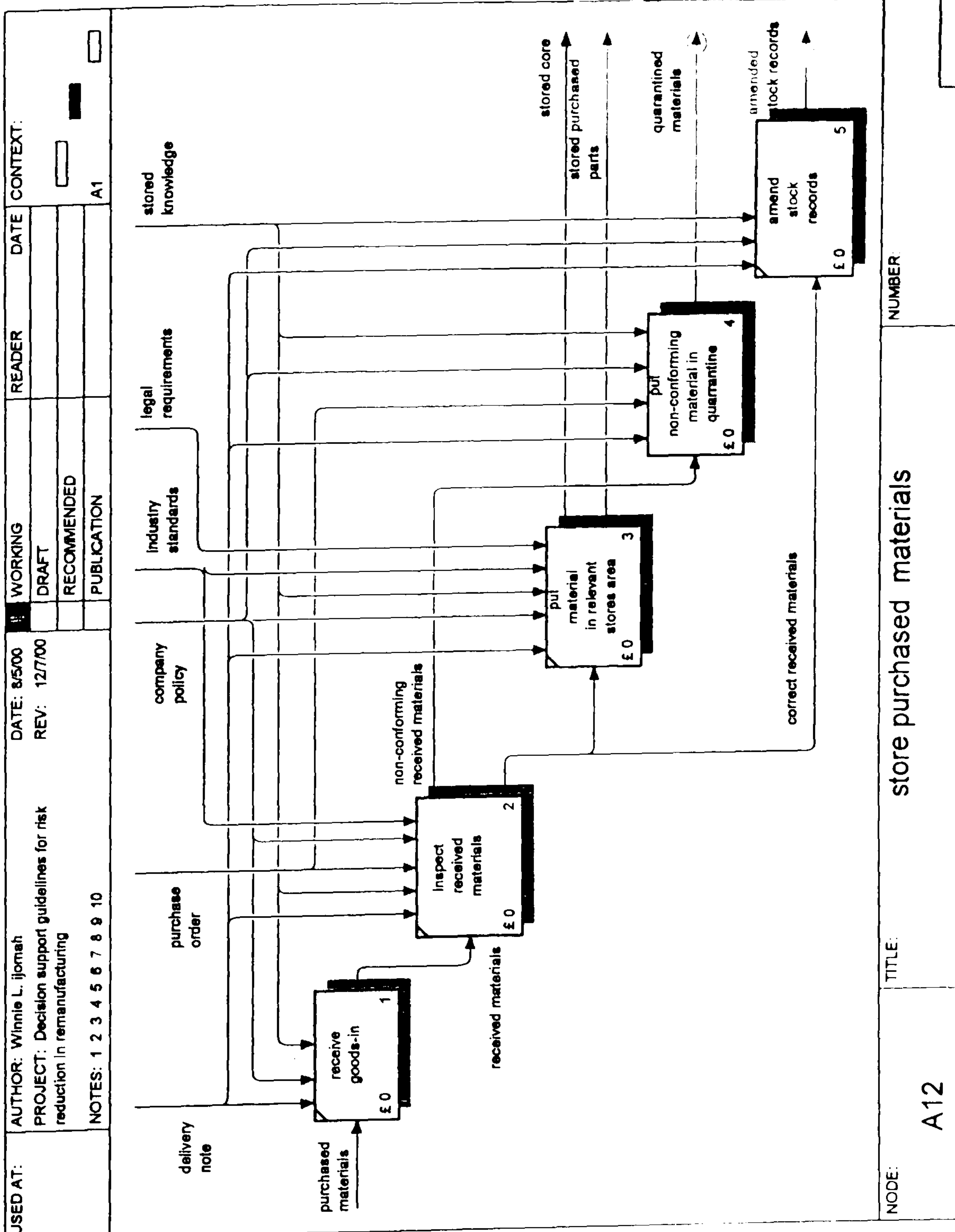

NODE: A12

TITLE: store purchased materials

NUMBER

USED AT:	AUTHOR: Winnie L. Ijomah	DATE: 8/8/00	WORKING	READER	DATE	CONTEXT:
	PROJECT: Decision support guidelines for risk reduction in remanufacturing	REV: 12/7/00	DRAFT			
			RECOMMENDED			
	NOTES: 1 2 3 4 5 6 7 8 9 10		PUBLICATION			A12

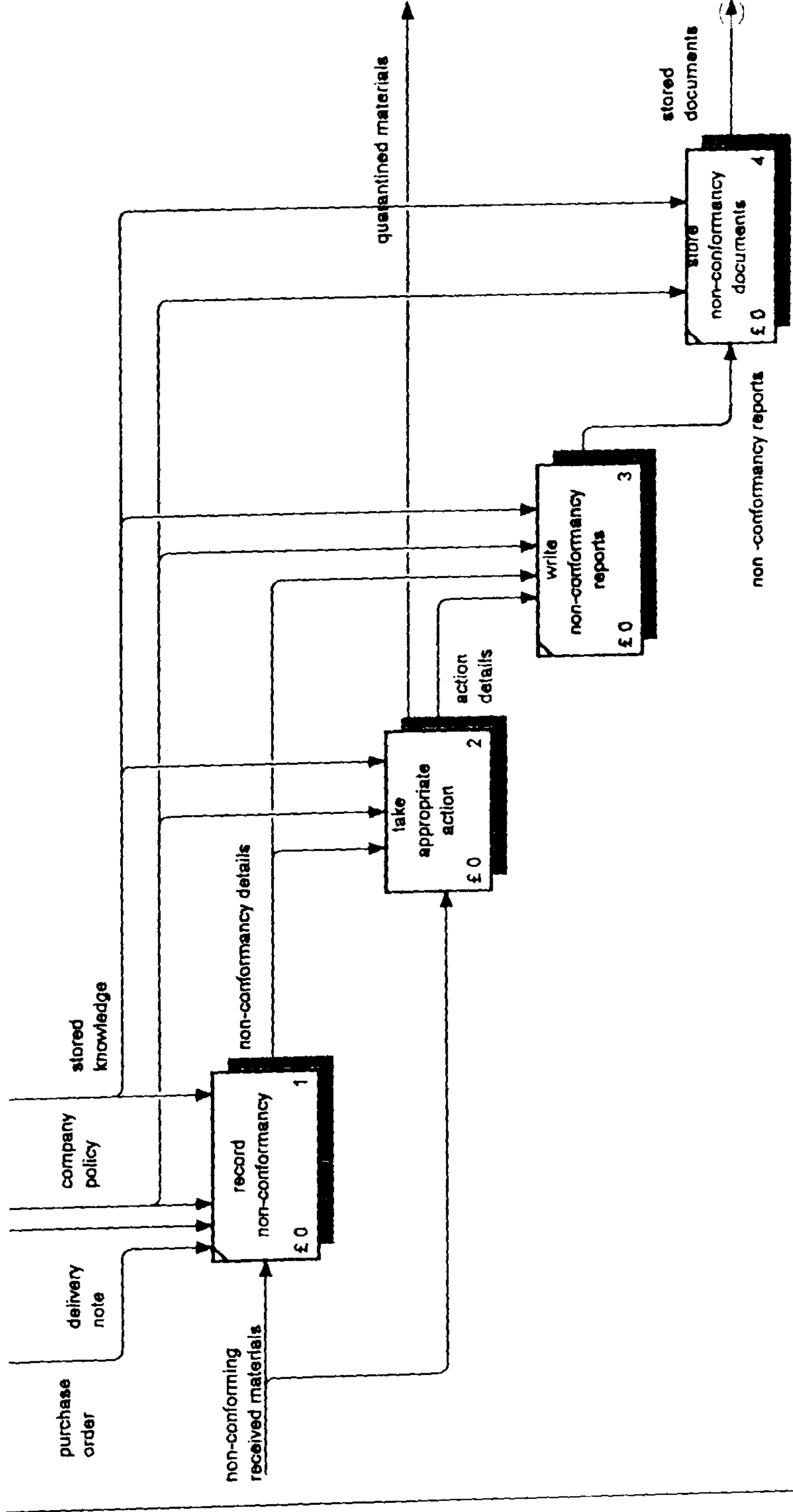

NODE: A124	TITLE: put non-conforming material in quarantine	NUMBER:
------------	--	---------



USED AT:	AUTHOR: Winnie L. Ijomah	DATE: 8/8/00	WORKING	READER	DATE	CONTEXT:
	PROJECT: Decision support guidelines for risk reduction in remanufacturing	REV: 12/7/00	DRAFT			
	NOTES: 1 2 3 4 5 6 7 8 9 10		RECOMMENDED			
			PUBLICATION			A124

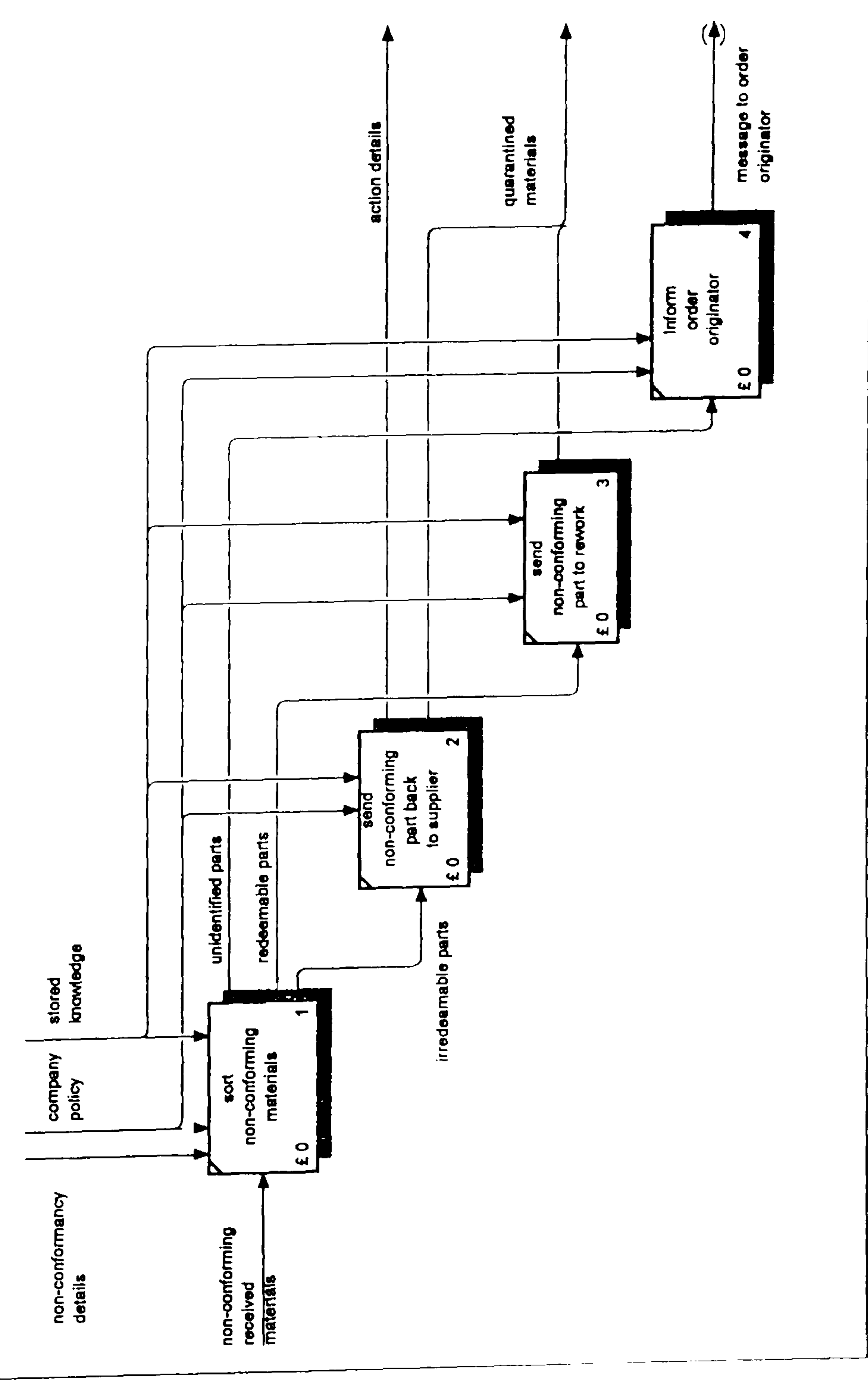

NODE: A1242	TITLE: take appropriate action	NUMBER:
-------------	--------------------------------	---------

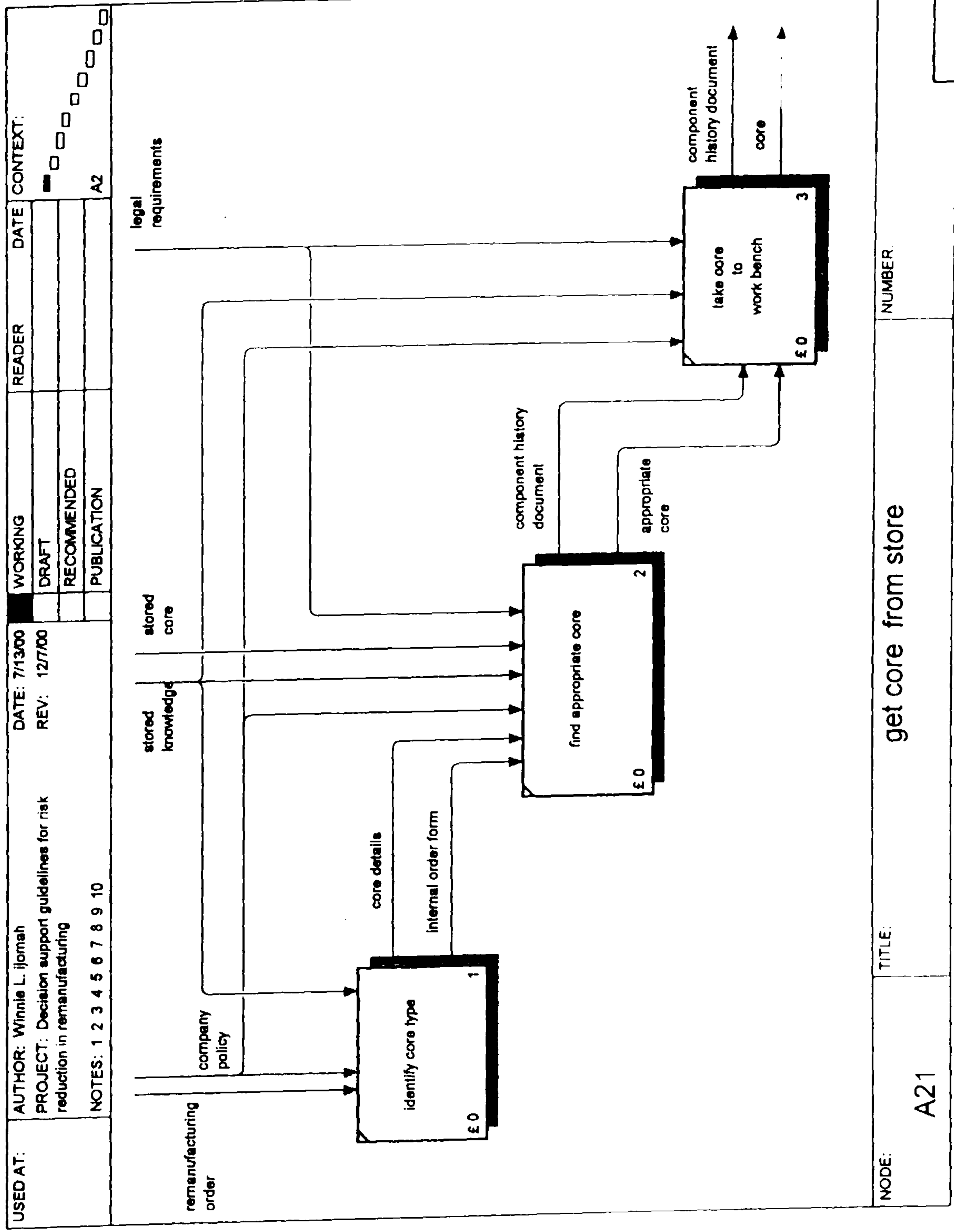

00

USED AT:	AUTHOR: Winnie L. Ijorah	DATE: 7/13/00	WORKING	READER	DATE	CONTEXT:
	PROJECT: Decision support guidelines for risk reduction in remanufacturing	REV: 12/7/00	DRAFT			<input type="checkbox"/>
	NOTES: 1 2 3 4 5 6 7 8 9 10		RECOMMENDED			<input type="checkbox"/>
			PUBLICATION			<input type="checkbox"/>
						A2 <input type="checkbox"/>

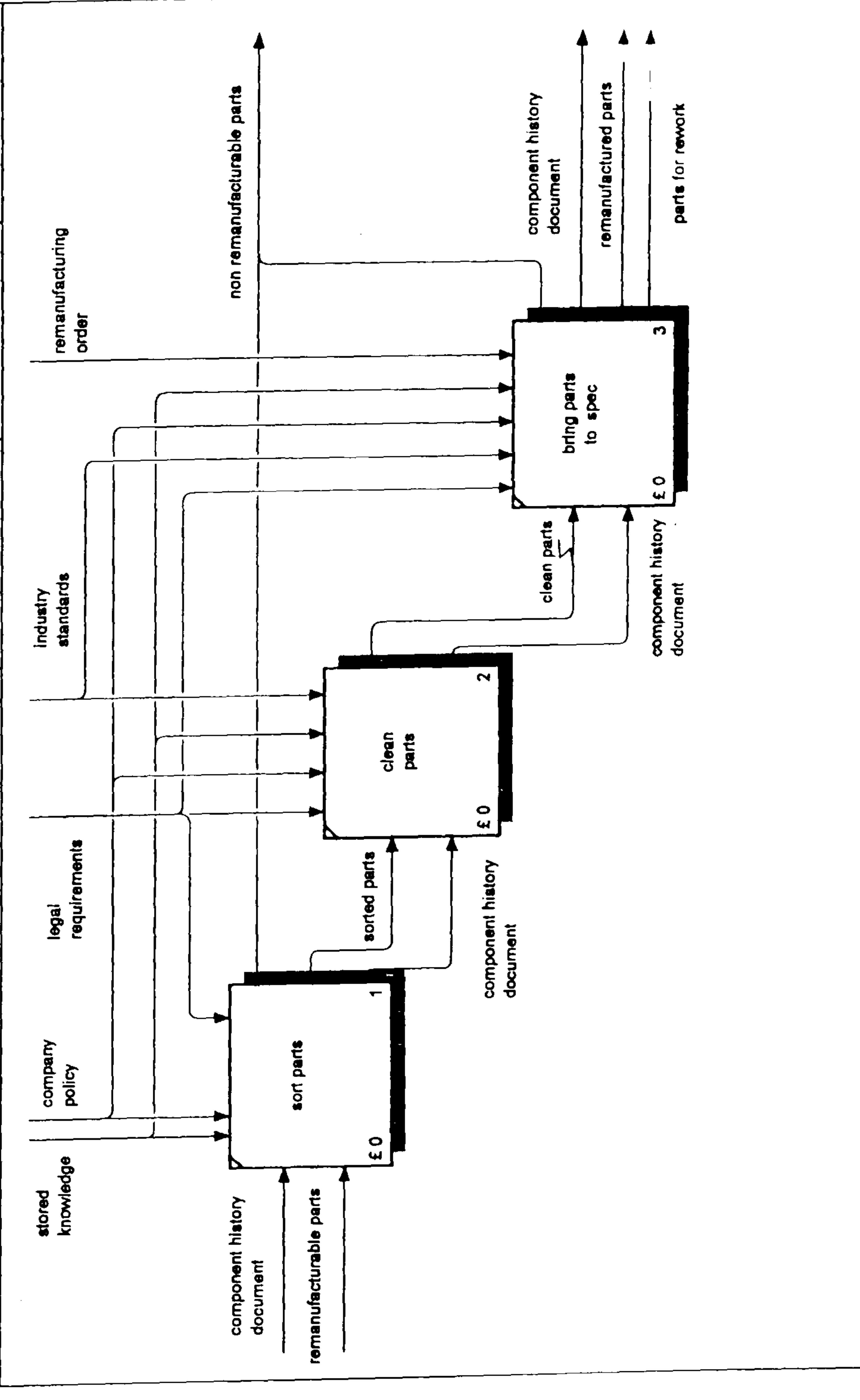

NODE: A23	TITLE: remanufacture parts	NUMBER:
-----------	----------------------------	---------

30

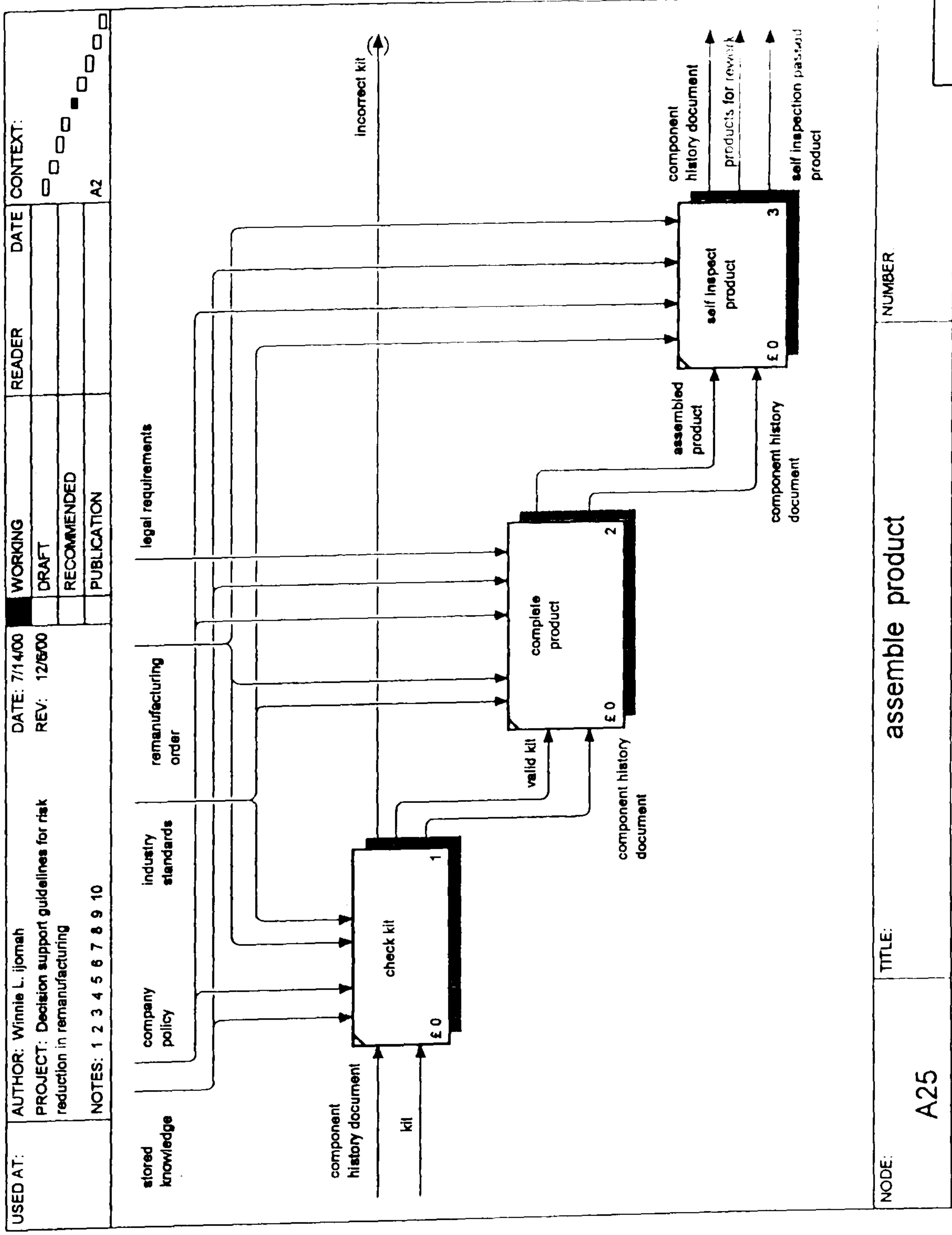

NODE: A25	TITLE: assemble product	NUMBER:
-----------	-------------------------	---------

USED AT:	AUTHOR: Winnie L. Jomah	DATE: 8/9/00	WORKING	READER	DATE	CONTEXT:
	PROJECT: Decision support guidelines for risk reduction in remanufacturing	REV: 12/7/00	DRAFT			<input type="checkbox"/> <input type="checkbox"/> <input type="checkbox"/> <input type="checkbox"/> <input type="checkbox"/>
	NOTES: 1 2 3 4 5 6 7 8 9 10		RECOMMENDED			A2
			PUBLICATION			

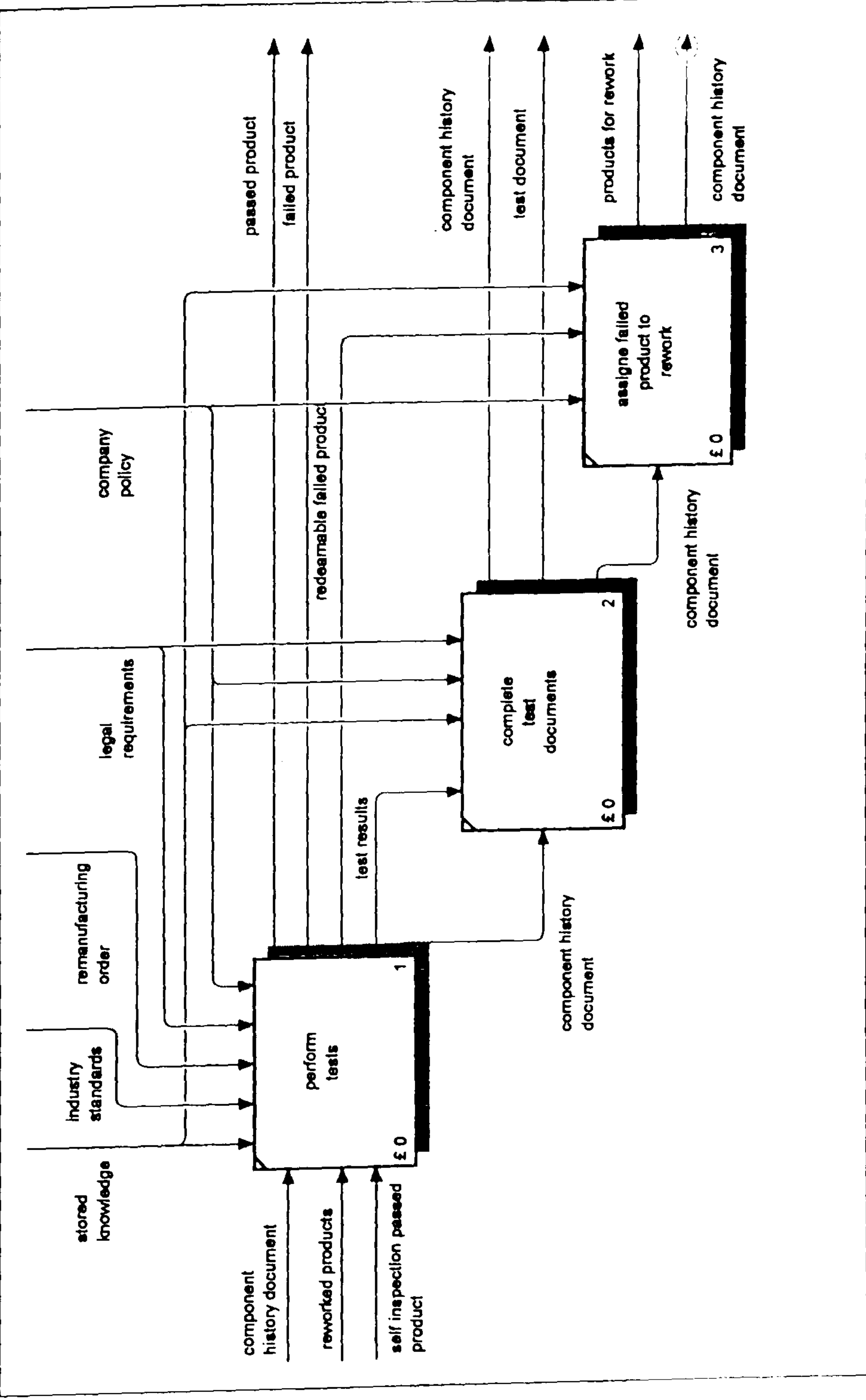

NODE: A26	TITLE: test product	NUMBER:
-----------	---------------------	---------

USED AT:	AUTHOR: Winnie L. Ijomah	DATE: 8/9/00	WORKING	READER	DATE	CONTEXT:
	PROJECT: Decision support guidelines for risk reduction in remanufacturing	REV: 12/6/00	DRAFT			<input type="checkbox"/> <input type="checkbox"/> <input type="checkbox"/> <input type="checkbox"/> <input type="checkbox"/> <input type="checkbox"/> <input type="checkbox"/>
	NOTES: 1 2 3 4 5 6 7 8 9 10		RECOMMENDED			A2
			PUBLICATION			

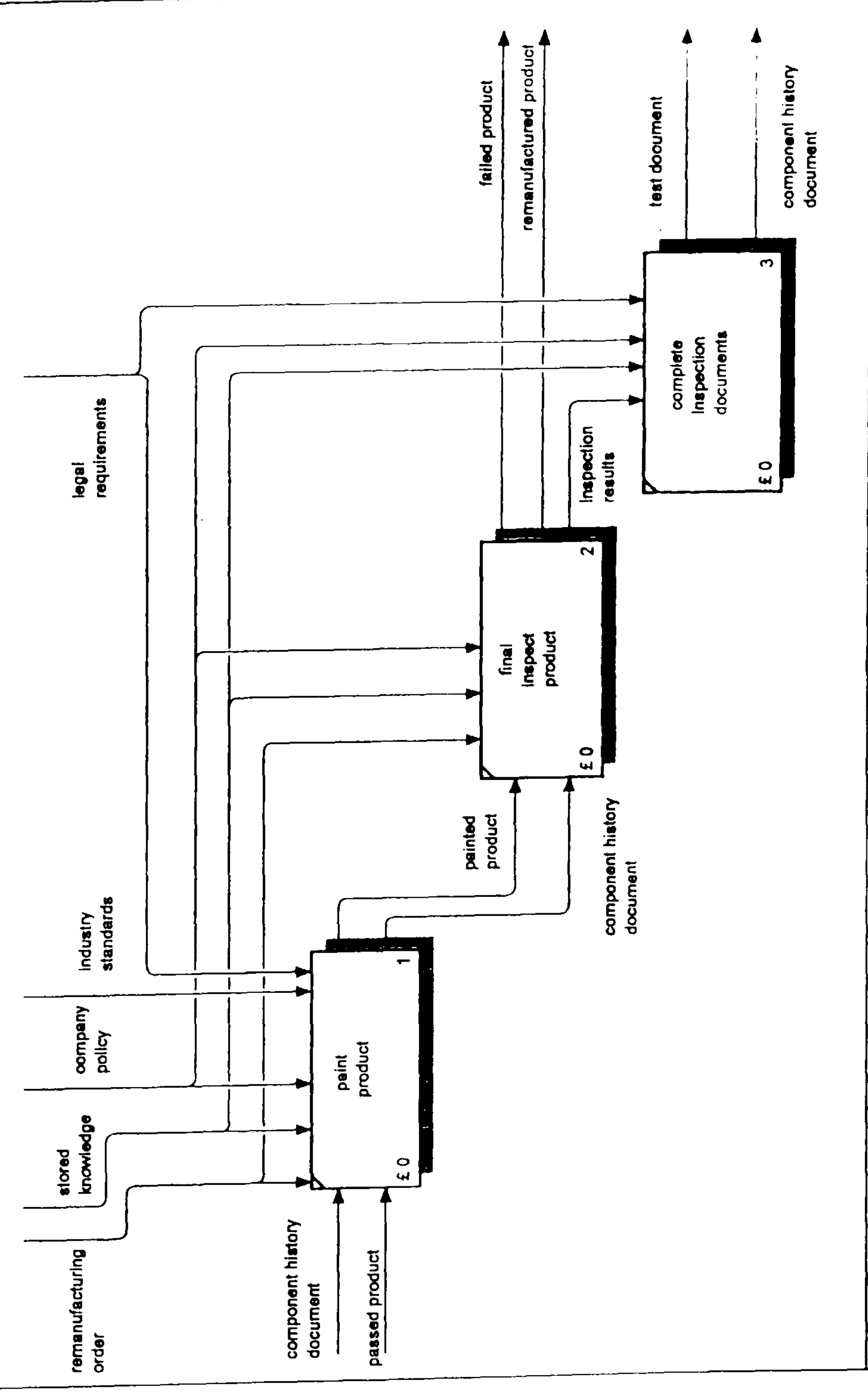

NODE: A27	TITLE: final inspect & finish	NUMBER:
------------------	--	---------

USED AT:	AUTHOR: Winnie L. Ijomah	DATE: 8/4/00	WORKING	READER	DATE	CONTEXT:
	PROJECT: Decision support guidelines for risk reduction in remanufacturing	REV: 12/6/00	DRAFT			<input type="checkbox"/> <input type="checkbox"/> <input type="checkbox"/> <input type="checkbox"/> <input type="checkbox"/> <input type="checkbox"/> <input type="checkbox"/> <input type="checkbox"/> <input type="checkbox"/> <input type="checkbox"/> <input type="checkbox"/>
	NOTES: 1 2 3 4 5 6 7 8 9 10		RECOMMENDED			A2
			PUBLICATION			<input type="checkbox"/>

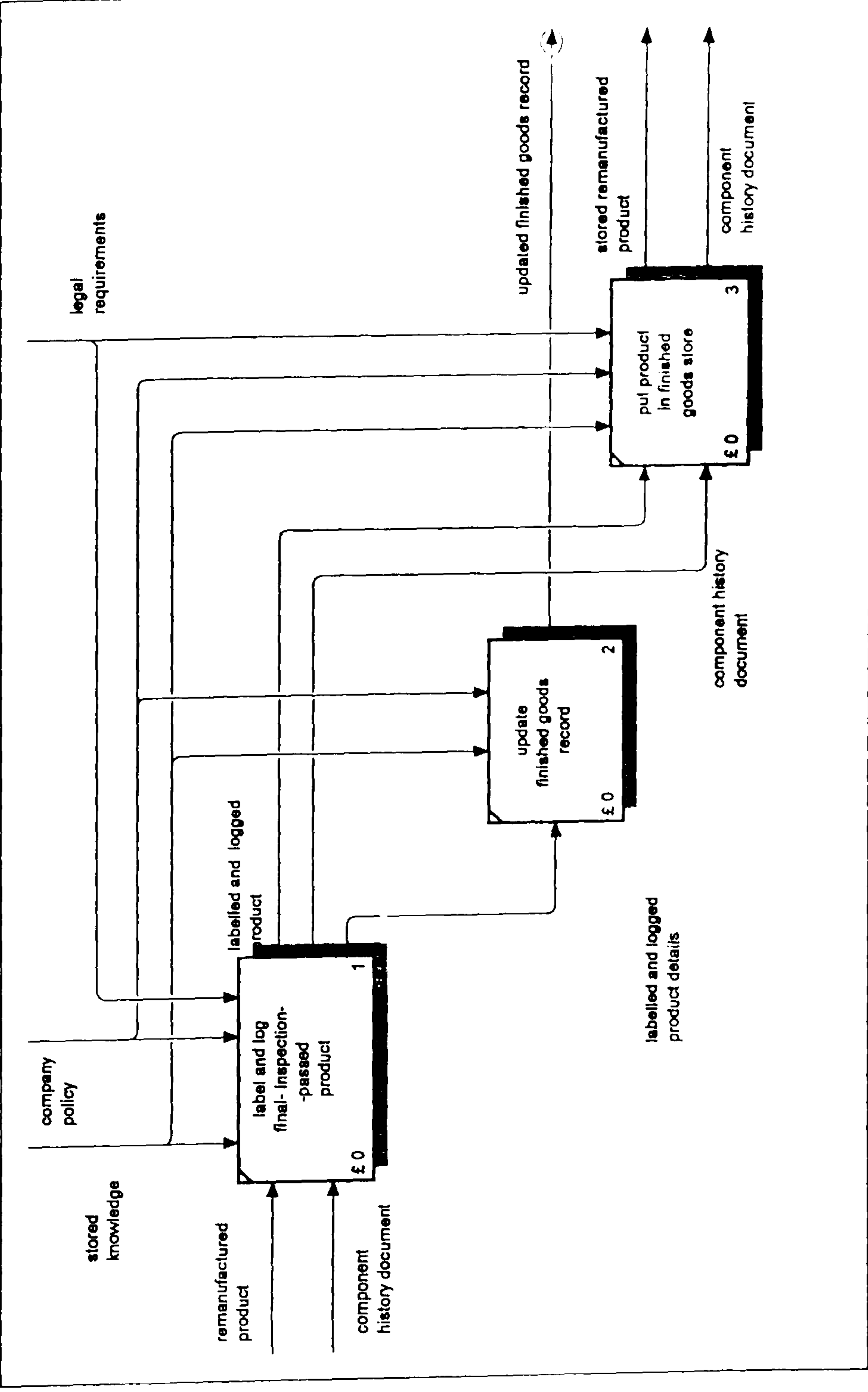

NODE: A28	TITLE: store product	NUMBER
-----------	----------------------	--------

3

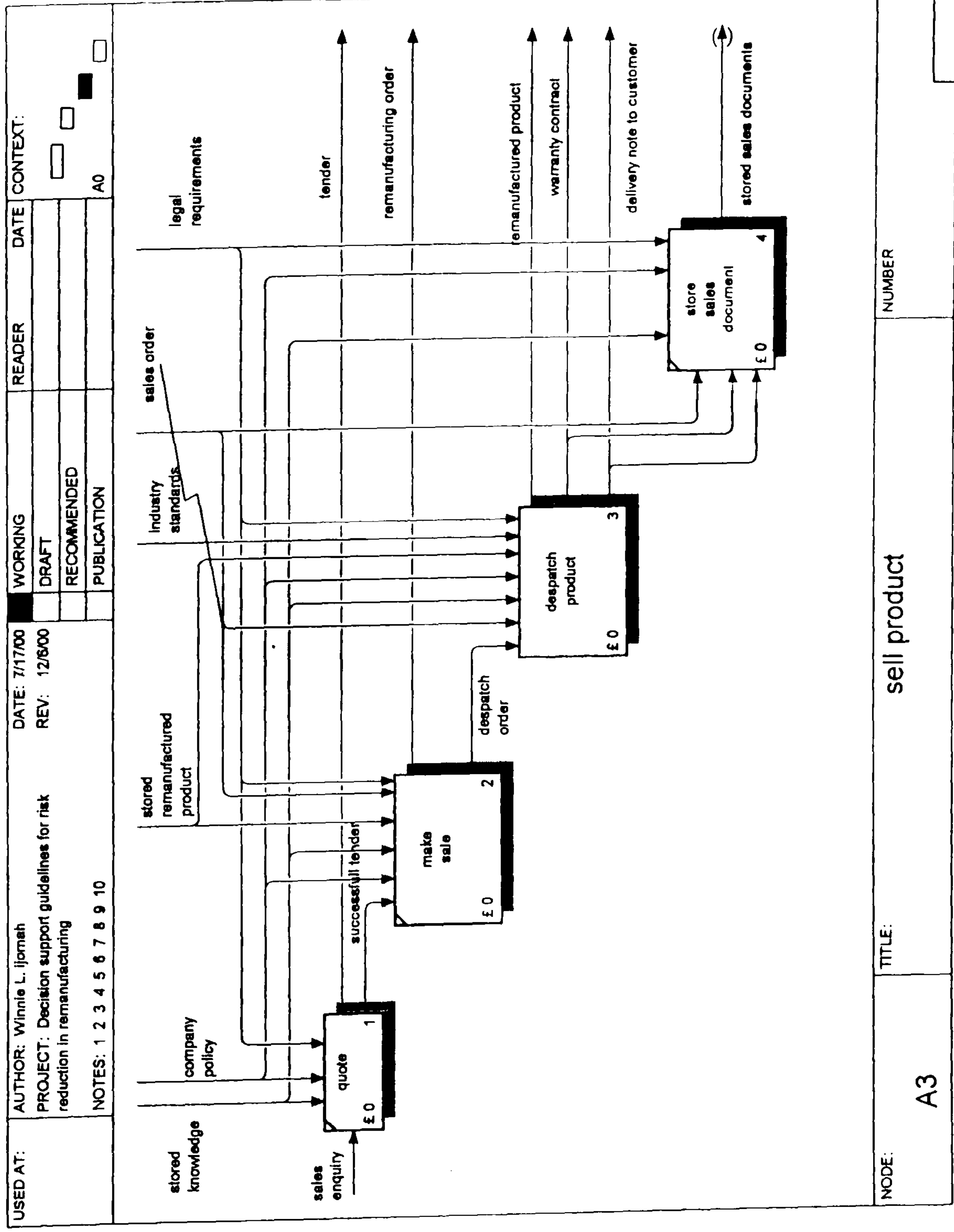

NODE: A3 TITLE: sell product NUMBER:

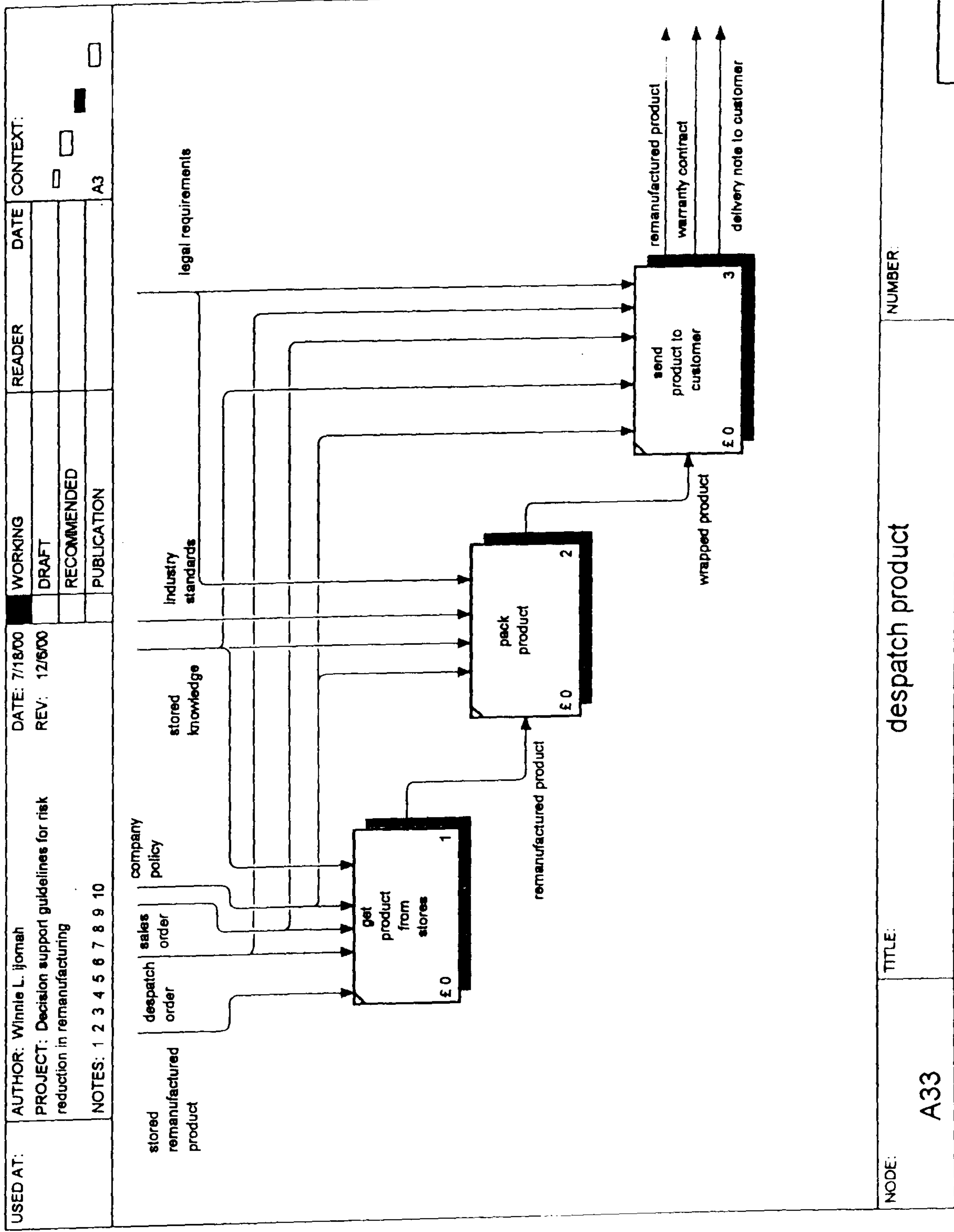

NODE: A33

TITLE: despatch product

NUMBER:

USED AT:	AUTHOR: Winnie L. Ijomah	DATE: 12/8/00	WORKING	READER	DATE	CONTEXT:
	PROJECT: Decision support guidelines for risk reduction in remanufacturing	REV: 12/8/00	DRAFT			
	NOTES: 1 2 3 4 5 6 7 8 9 10		RECOMMENDED			
			PUBLICATION			A0

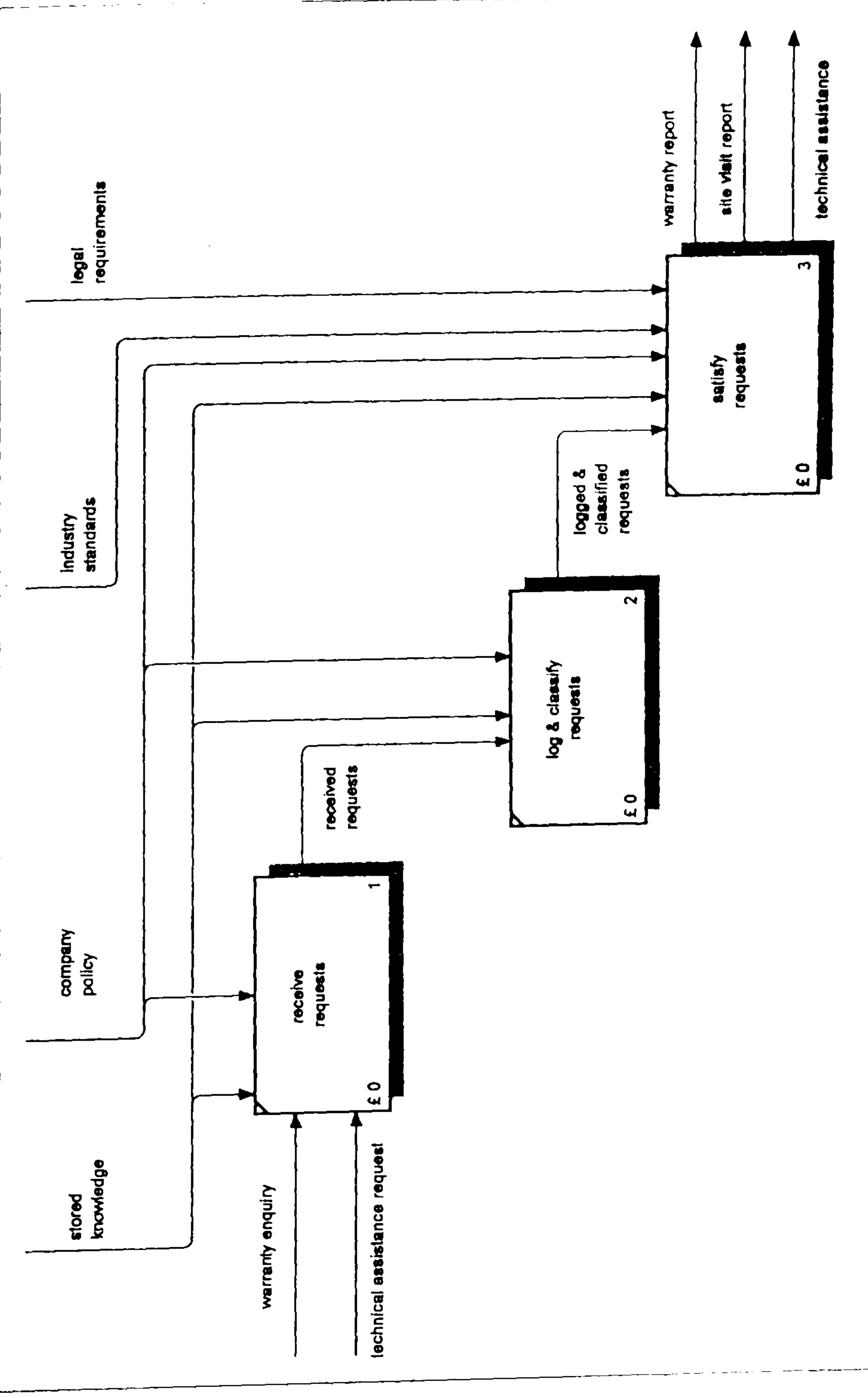

NODE:	A4	TITLE:	support customer	NUMBER:	
-------	----	--------	------------------	---------	--



Description of the remanufacturing business process model

Winnie Ijomah, Department for Business Development
October 2000

1. Initial description of the model (A0-A11)

A-0: Run remanufacturing business

This is a basic diagram of the environment of the remanufacturing business. It shows the interaction of the business with its environment. For example:

- Technical assistance request, sales and warranty request from customers.
- Remanufactured product, warranty contracts and technical assistance to customers.
- Purchase order to suppliers.
- Legal controls such as industry standards.

A0: Run Remanufacturing Business

Basic description

This diagram displays the four major activities that make up the remanufacturing business process. These activities are:

Obtain raw material: purchase externally supplied parts that are needed to remanufacture products. These include cores, conventionally manufactured components and externally remanufactured components.

Remanufacture product: Return the core to Original Equipment Manufacturer (OEM) current specification.

Sell product: Give the remanufactured product to a customer in return for money

Support customer: Help the customer through services such as warranty obligations, technical assistance (e.g. installation and help in choosing an appropriate product).

Detailed description without bringing in the activity controls

A01: Obtain raw materials

When we get a sales enquiry we sell the product if we have a finished one available. If we do not have a finished product available then we obtain the raw materials needed to remanufacture. The outputs of the obtain raw materials activity are

- Stored purchased parts
- Stored core.
- Purchase order to suppliers to get required parts that we do not have.

A02: Remanufacture product

Once the required purchased parts and core are available (Shown as stored purchased parts and stored core) we can remanufacture the product. The results of our remanufacturing operation are:

- Scrap (waste)
- Stored remanufactured product (remanufactured product in finished goods store awaiting purchase)

A03: Sell product

Once we have a sales enquiry we are in position to sell. The outputs of the sell product activity are:

- Remanufacturing order if we do not have a completed product available
- A remanufactured product dispatched to a customer
- A warranty contract dispatched to a customer
- A delivery note to the customer
- A tender to the customer following sales inquiry. If the tender is successful then we receive a sales order and can begin remanufacturing the product.

A04: Support customer

The fourth activity of the remanufacturing business process is the support customer activity and this can take place before or after the selling of the product. We support the customer by offering services such as these:

- Technical assistance. For example, installation service for customers *after* they have purchased, help for customers in choosing the correct product even *before* they purchase, replacement product while we remanufacture customers products.
- Warranty. For example, giving and honouring warranty contract.
- Technical quote. For example, carrying out site visits and product inspections to give realistic estimates of the cost and feasibility of remanufacturing customers' broken products.

Detailed description bringing in the activity controls

A0 will be explained again. However this time the information from the inputs (triggers), outputs (results) and control (rules or limitations) as shown in the diagram, will be pulled in. This will help to further illustrate how the model works is read.

A01: Obtain raw materials

When we get a sales enquiry and we do not have a finished product available we obtain the raw materials needed to remanufacture. However, we can obtain the raw materials we need only if the following are available:

- Core. If cores are not available then we cannot buy any
- Opportunity to purchase.
- Externally supplied parts. OEMs may decide not to sell parts to us. Some parts may be difficult and time consuming to obtain.
- Available capital. If we cannot pay we cannot buy.
- Experience. We need some experience to ensure that we are buying the correct parts and cores
- Company policy. Every company has its rules on how it wants to operate.

The result/output of the obtain raw materials activity are:

- Purchase order to suppliers in order to get the parts that we need.
- stored purchased parts
- Stored core.

A02: Remanufacture product

Once the required purchased parts and core are available (Shown as stored purchased parts and stored core) we are ready to remanufacture provided that the following controls are satisfied:

- Company policy. For example, certain documentation must be consulted.
- Experience. Remanufacturing requires a level of expertise and knowledge
- Industry standards. The industry has laid down certain terms and conditions and we must observe these. For example we must work to OEM specification.
- Required purchased parts must be available and ready in our store
- Required core must be available and ready in our store

The outputs of our remanufacturing operation are:

- Scrap (waste).
- Stored remanufactured product.

A03: Sell product

Once we have a sales enquiry we are in position to sell. However we cannot sell unless the following are available:

- A sales order
- A stored remanufactured product.
- Experience
- Company policy
- Industry standards. For example we must provide a certain level of warranty and package the product in a particular fashion.

The output of the sell product activity are:

- Remanufacturing order if we do not have a completed product available
- A remanufactured product
- A warranty contract
- A delivery note to the customer
- A tender to the customer following sales enquiry in order to get the sales order

A1: Obtain raw materials

This sub activity has four components which are:

Purchase materials: obtain our material requirements.

Store purchased material: Put the material that we have accepted in storage.

Store documentation: File the paper work relating to our purchases.

A1: Detailed description (controls shown in Italics)

A11: Purchase materials

When we get a sales enquiry we purchase our material requirements according to the rules of our *experience* and *company policy*, provided that we have *available capital* required for purchasing. In addition to these constraints, we must have the *opportunity* to purchase and also, there must be *externally supplied parts* and *cores* available for purchasing.

The output of the purchase materials activity are:

- Purchased materials
- Delivery note
- Purchase order

A12: Store purchased material

When purchased materials arrive we store them according to the rules of our *company policy* and *experience*.

The outputs of the store purchased material activity are:

- Stored purchased parts
- Stored core

A13: Store documentation

When delivery notes and purchase orders arrive, we store them according to the rules of our *company policy* and *experience*.

The output of the store documentation activity is:

- Stored documents

A11: Purchase materials

This sub activity has four components:

Sort material requirements: Group our material requirements by type

Buy cores: Get the cores we need

Buy parts: Obtain the externally supplied components that we need

Receive purchased materials: Take delivery of the externally purchased materials that we have obtained.

Detailed description of A11: purchase materials (controls shown in Italics)**A111: Sort materials requirement**

When we obtain a sales enquiry, we sort our materials requirements according to the rules and controls of our *company policy* and *our experience*. The results of the sort materials requirement are:

- Purchase order sent to the customer in order to get the supplies we need
- Information about our core requirements
- Information about our parts requirements

A112: Buy cores

When we get information about our core requirements we purchase cores according to the rules of our *company policy*. However, this is possible only if there is the *opportunity* to purchase and we have *available capital* with which to purchase and at the same time *cores are available* for purchase. The output of the buy core activity is:

- Purchased cores.

A113: Buy Parts

When we get information about our parts requirements we purchase parts according to the rules of our *company policy*, providing that we have the *available capital* and *experience* required for purchasing and at the same time *externally supplied parts* are available for purchase. The output of the buy parts activity is:

- Purchased parts

A114: Receive purchased materials

When purchased parts and purchased cores arrive we receive them according to the rules of our *company policy* and *experience*.

The output of receiving purchased materials are:

- Purchased materials
- Delivery note.

2. Systematic Validation of the Model

Introduction

The purpose of this part of the document is to help you to form opinions about the model in terms of its:

- Suitability: (Do you, as remanufacturers believe that the model is an effective method of describing the remanufacturing business process).
- Sufficiency: (Do you, as a remanufacturer believe that the model display the major activities and information flows of the remanufacturing business process).
- Clarity: (Do you, as a remanufacturer find the model understandable)

The information that we receive from you will allow us to enhance the model's usefulness to you.

A2 Subprocess: The remanufacturing operation

This is the major part of the remanufacturing business process. It is concerned with returning the used product (core) to current OEM specification and is composed of the following 9 major activities:

1. **Get core from store:** selecting the required core from the remanufacturer's store.
2. **Strip core:** reduce the core to its components.
3. **Remanufacture parts:** bringing the components to current OEM specification.
4. **Store parts and kit:** put the remanufactured parts into inventory store and assemble all the component types required to produce the finished product.
5. **Assemble product:** put the parts contained in the kit together to build the remanufactured product.
6. **Test product:** Carry out the assessments required to ascertain that the product is of current OEM specification.
7. **Final inspection & paint:** visual inspection for cosmetic reasons and painting to original colour.
8. **Store Product:** Put product in finished goods store to await sale or dispatch to customer.
9. **Store production documents:** File the papers that relate to the job.

Only activities 2 and 3 differ significantly from conventional manufacturing therefore we will analyse the first few levels of each of these paying particular attention to activity 3; the remanufacturing of component parts.

A22: Strip core: Dismantling the core and reducing it to component level

This activity involves:

- Ascertaining that the correct core has been picked using experience, company policy (e.g. use of documentation such as OEM manual).
- Dismantling the used product (core) to its component
- Visual inspection to eliminate obviously non-reusable parts (e.g. parts that are obviously damaged beyond remanufacturing, obsolete parts and parts where the cost of remanufacturing exceeds the cost of purchasing new.)
- Discarding of the eliminated parts

A23: Remanufacture Parts: bringing of parts to *current OEM specification*

This is the most crucial part of remanufacturing operation. It makes or breaks the remanufacturer because it determines the issues of cost and quality and these are the essential measures of competent remanufacturing.

This activity has four main elements:

A231: Sort parts. This requires detailed inspection of the components to sort them according to reclaimable and non-reclaimable groups then further sorting by type or size for example to facilitate effective cleaning.

A232: Clean parts: This is the removing of dirt and contamination such as rust from the components

A233: Bring parts to current specification: This involves gauging the parts, deciding how best to bring them to current specification and finally remanufacturing them. Parts that have not been successfully remanufactured are put back into the system as rework and will keep on going through the rework and test cycle until they are adequate or else a decision is taken that they are beyond remanufacturing.

A234. Bin parts. This is the discarding of the parts that cannot be successfully remanufactured.

The outputs of A23: remanufacture parts are:

- Scrap (waste)
- Updated work assessment sheet
- Remanufactured parts

A23: Detailed description

Please note that for clarity:
Activities are given in black Italics (**activity**)
Controls are shown in light Italics (*controls*)
Outputs are underlined (output)

When work assessment sheet and remanufacturable parts arrive we prepare to *sort parts*. We sort the parts according to the rules of our *experience* and *company policy*. This produces sorted parts, scrap and updated work assessment sheet.

The scrap goes onto the *bin parts* activity where they are discarded. The sorted parts travels with the updated work assessment sheet to the *clean parts* activity where the

sorted parts are cleaned according to the rules of *company policy, industry standards and experience*.

The **clean parts** activity produces clean parts and updated work assessment sheet which go on to the **bring parts to current spec** activity. There they are remanufactured according to the rules of *industry standards, remanufacturing order, company policy and experience*. This produces an updated work assessment sheet, successfully remanufactured parts, irredeemable non-spec parts and rework.

The rework go back into the system for further processing while the irredeemable non-spec parts go on to the **bin parts** activity where they are discarded.

A233: Bring parts to current specification

I will now concentrate on A233: Bring parts to current specification. This is the component assessment program. It is the most crucial element of the remanufacturing operation because it is here that the essential decisions about the suitability of components for reuse are made. Because of this, inadequacy in this area can lead to losses in terms high remanufacturing costs, long remanufacturing cycle time and poor reputation. Please refer to the various papers for elaboration on these issues.

A233: Bring parts to current specification

This activity is composed of the following parts:

A2331: rework parts. Bring/attempt to bring parts to current specification

A2332: clean reworked parts: remove dust, grease etc from the reworked parts

A2333: inspection/test reworked parts. Gauge the components to ascertain that they are successfully remanufactured.

Output of this stage A233: Bring parts to current specification is:

- remanufactured parts.
- Updated work assessment sheet.
- Rework
- irredeemable non-spec parts.

A233: Detailed description

Please note that for clarity:
Activities given in black Italics (**activity**)
Controls are shown in light Italics (*controls*)
Outputs are underlined (output)

When clean parts arrive with a work assessment sheet at the **rework parts** activity we rework the clean parts according to the rules given by the *remanufacturing order, industry standards, company policy* and *experience*. This produces reworked parts and an updated work assessment sheet.

These outputs travel together to the next activity that is called **clean reworked parts**. There, they are cleaned according to the rules laid down by the *industry standards, company policy* and *experience*. This outputs cleaned reworked parts that travel with the updated work assessment sheet to the next activity that is called **inspect/test reworked parts**. At that activity the cleaned reworked parts are assessed for correctness according to the rules laid back by the *industry standards, company policy* and *experience*.

The outputs of the **inspect/test reworked parts** activity are, remanufactured parts, updated work assessment sheet, rework and irredeemable non-spec parts.

Completed initial feedback sheets

November Validation Feedback Sheet

Name: **A.J
TESTA**

Organisation: **Company F**

Position:

Please tick one box on each line to show how far you agree with each statement.

		Strongly Agree	Agree	Neither	Disagree	Strongly disagree
1	Many major information flows and activities have been omitted in this model.					
2	This model displays the required information clearly.					
3	This model is an adequate representation of the remanufacturing business process					
4	I find many details in this model ambiguous					
5	This model does not reflect the remanufacturing business process to any great extent					
6	Only a few major activities and information flows have been omitted in this model					
7	This model is correct in the way that it shows the basic elements of the remanufacturing business process					
8	I find this model easy to comprehend					
9	I feel that this model captures the major information flows and activities of a remanufacturing business process					
10	I can analyse the information flows and activities of the remanufacturing business with this model					
11	Only a few major information flows and activities are missing in this model					

Name: **A. T. TESTA**

Organisation: **Company F**

Position: **Q. Manager**

Please tick one box on each line to show how far you agree with each statement.

		Strongly Agree	Agree	Neither	Disagree	Strongly disagree
12	This model is an acceptable description of the basic remanufacturing business process		✓			
13	This model requires many alterations before it can describe the remanufacturing business process				✓	
14	This model is extremely difficult to understand				✓	
15	I would not use this model to give a basic description of the remanufacturing business process					
16	Generally, this model is logical in the way that it describes the remanufacturing business process		✓			
17	This model is a poor representation of the remanufacturing business process					✓
18	I do not recognise this model as being that of the remanufacturing business process					
19	I find this model easy to follow		✓			
20	I would consider using this model to describe the remanufacturing business process		✓			
21	Many major details are missing in this model	⓪				

22 Any additional comments:

① TIME TO DISCUSS WITH STAFF IN MY COMPANY FOR THEIR OPINIONS. & COMMENT.

② DIFFERENT EYES SEE DIFFERENT THINGS. ALSO MANY OF MY STAFF HAVE MUCH LONGER SERVICE THAN I IN THIS INDUSTRY.

THANK YOU FOR YOUR TIME

& I WILL FEED BACK THE INFO

Validation Feedback sheet

Name: L. Allman Organisation: De Montfort University Position: Research

please tick one box on each line to show how far you agree with each statement

Hidden text			Strongly Agree	Agree	Neither	Disagree	Strongly disagree
SF	1	Many major information flows and activities have been omitted in this model.			✓		
C	2	This model displays the required information clearly.		✓			
ST	3	This model is an adequate representation of the remanufacturing business process	✓				
C	4	I find many details in this model ambiguous		✓			
ST	5	This model does not reflect the remanufacturing business process to any great extent				✓	
SF	6	Only a few major activities and information flows have been omitted in this model	✓				
ST	7	This model is correct in the way that it shows the basic elements of the remanufacturing business process	✓				
C	8	I find this model easy to comprehend		✓			
SF	9	I feel that this model captures the major information flows and activities of a remanufacturing business process		✓			
C	10	I can analyse the information flows and activities of the remanufacturing business with this model			✓		
SF	11	Only a few major information flows and activities are missing in this model	✓				

CODE: C: Clarity; SF: Sufficiency; ST: Suitability

Name: *L. Allman*

Organisation: *De Montfort University*

Position: *Research*

Please tick one box on each line to show how far you agree with each statement.

<i>Hidden text</i> ↓			Strongly Agree	Agree	Neither	Disagree	Strongly disagree
ST	12	This model is an acceptable description of the basic remanufacturing business process		✓			
SF	13	This model requires many alterations before it can describe the remanufacturing business process			✓		
C	14	This model is extremely difficult to understand	✓				
ST	15	I would not use this model to give a basic description of the remanufacturing business process					✓
C	16	Generally, this model is logical in the way that it describes the remanufacturing business process	✓				
SF	17	This model is a poor representation of the remanufacturing business process				✓	
ST	18	I do not recognise this model as being that of the remanufacturing business process					✓
C	19	I find this model easy to follow		✓			
ST	20	I would consider using this model to describe the remanufacturing business process	✓				
SF	21	Many major details are missing in this model			✓		

22 Any additional comments:

THANK YOU FOR YOUR TIME

November Validation Feedback Sheet

Name: John Mackie Organisation: Company J Position: MD

Please tick one box on each line to show how far you agree with each statement.

		Strongly Agree	Agree	Neither	Disagree	Strongly disagree
1	Many major information flows and activities have been omitted in this model.				✓	
2	This model displays the required information clearly.			✓		
3	This model is an adequate representation of the remanufacturing business process		✓			
4	I find many details in this model ambiguous			✓		
5	This model does not reflect the remanufacturing business process to any great extent				✓	
6	Only a few major activities and information flows have been omitted in this model		✓			
7	This model is correct in the way that it shows the basic elements of the remanufacturing business process		✓			
8	I find this model easy to comprehend		✓			
9	I feel that this model captures the major information flows and activities of a remanufacturing business process		✓			
10	I can analyse the information flows and activities of the remanufacturing business with this model		✓			
11	Only a few major information flows and activities are missing in this model		✓			

Name: JOHN
MACKIE

Organisation: Company J

Position: M.D

Please tick one box on each line to show how far you agree with each statement.

		Strongly Agree	Agree	Neither	Disagree	Strongly disagree
12	This model is an acceptable description of the basic remanufacturing business process		✓			
13	This model requires many alterations before it can describe the remanufacturing business process				✓	
14	This model is extremely difficult to understand				✓	
15	I would not use this model to give a basic description of the remanufacturing business process			✓		
16	Generally, this model is logical in the way that it describes the remanufacturing business process		✓			
17	This model is a poor representation of the remanufacturing business process				✓	
18	I do not recognise this model as being that of the remanufacturing business process				✓	
19	I find this model easy to follow		✓			
20	I would consider using this model to describe the remanufacturing business process		✓			
21	Many major details are missing in this model				✓	

22 Any additional comments:

THANK YOU FOR YOUR TIME

Validation Feedback sheet

Name: H Parkinson Organisation: Company L Position: MD

please tick one box on each line to show how far you agree with each statement

Hidden text ↓			Strongly Agree	Agree	Neither	Disagree	Strongly disagree
SF	1	Many major information flows and activities have been omitted in this model.				✓	
C	2	This model displays the required information clearly.		✓			
ST	3	This model is an adequate representation of the remanufacturing business process		✓			
C	4	I find many details in this model ambiguous			✓		
ST	5	This model does not reflect the remanufacturing business process to any great extent				✓	
SF	6	Only a few major activities and information flows have been omitted in this model		✓			
ST	7	This model is correct in the way that it shows the basic elements of the remanufacturing business process		✓			
C	8	I find this model easy to comprehend		✓			
SF	9	I feel that this model captures the major information flows and activities of a remanufacturing business process		✓			
C	10	I can analyse the information flows and activities of the remanufacturing business with this model	✓				
SF	11	Only a few major information flows and activities are missing in this model				✓	

CODE: C: Clarity; SF: Sufficiency; ST: Suitability

Name: *Parkinson*

Organisation: *Company L*

Position: *M.D*

Please tick one box on each line to show how far you agree with each statement.

Hidden text			Strongly Agree	Agree	Neither	Disagree	Strongly disagree
ST	12	This model is an acceptable description of the basic remanufacturing business process		✓			
SF	13	This model requires many alterations before it can describe the remanufacturing business process			✓		
C	14	This model is extremely difficult to understand				✓	
ST	15	I would not use this model to give a basic description of the remanufacturing business process				✓	
C	16	Generally, this model is logical in the way that it describes the remanufacturing business process		✓			
SF	17	This model is a poor representation of the remanufacturing business process				✓	
ST	18	I do not recognise this model as being that of the remanufacturing business process					✓
C	19	I find this model easy to follow	✓	✓			
ST	20	I would consider using this model to describe the remanufacturing business process	✓				
SF	21	Many major details are missing in this model				✓	

22 Any additional comments:

Good way to break down process for quality assurance, costing, information capture

THANK YOU FOR YOUR TIME

November Validation Feedback Sheet

Name: LOUIE RANDON

Organisation: Company K

Position: Project Manager

Please tick one box on each line to show how far you agree with each statement.

		Strongly Agree	Agree	Neither	Disagree	Strongly disagree
1	Many major information flows and activities have been omitted in this model.					✓
2	This model displays the required information clearly.	✓				
3	This model is an adequate representation of the remanufacturing business process		✓			
4	I find many details in this model ambiguous				✓	
5	This model does not reflect the remanufacturing business process to any great extent					✓
6	Only a few major activities and information flows have been omitted in this model	✓				
7	This model is correct in the way that it shows the basic elements of the remanufacturing business process	✓				
8	I find this model easy to comprehend		✓			
9	I feel that this model captures the major information flows and activities of a remanufacturing business process	✓				
10	I can analyse the information flows and activities of the remanufacturing business with this model	✓				
11	Only a few major information flows and activities are missing in this model	✓				

Name:

Organisation: *Company K*

Position: *Project Manager*

Please tick one box on each line to show how far you agree with each statement.

		Strongly Agree	Agree	Neither	Disagree	Strongly disagree
12	This model is an acceptable description of the basic remanufacturing business process	<input checked="" type="checkbox"/>	<input type="checkbox"/>	<input type="checkbox"/>	<input type="checkbox"/>	<input type="checkbox"/>
13	This model requires many alterations before it can describe the remanufacturing business process	<input type="checkbox"/>	<input type="checkbox"/>	<input type="checkbox"/>	<input checked="" type="checkbox"/>	<input type="checkbox"/>
14	This model is extremely difficult to understand	<input type="checkbox"/>	<input type="checkbox"/>	<input type="checkbox"/>	<input checked="" type="checkbox"/>	<input type="checkbox"/>
15	I would not use this model to give a basic description of the remanufacturing business process	<input type="checkbox"/>	<input type="checkbox"/>	<input type="checkbox"/>	<input type="checkbox"/>	<input checked="" type="checkbox"/>
16	Generally, this model is logical in the way that it describes the remanufacturing business process	<input type="checkbox"/>	<input type="checkbox"/>	<input type="checkbox"/>	<input type="checkbox"/>	<input checked="" type="checkbox"/>
17	This model is a poor representation of the remanufacturing business process	<input type="checkbox"/>	<input type="checkbox"/>	<input type="checkbox"/>	<input type="checkbox"/>	<input checked="" type="checkbox"/>
18	I do not recognise this model as being that of the remanufacturing business process	<input type="checkbox"/>	<input type="checkbox"/>	<input type="checkbox"/>	<input type="checkbox"/>	<input checked="" type="checkbox"/>
19	I find this model easy to follow	<input type="checkbox"/>	<input checked="" type="checkbox"/>	<input type="checkbox"/>	<input type="checkbox"/>	<input type="checkbox"/>
20	I would consider using this model to describe the remanufacturing business process	<input checked="" type="checkbox"/>	<input type="checkbox"/>	<input type="checkbox"/>	<input type="checkbox"/>	<input type="checkbox"/>
21	Many major details are missing in this model	<input type="checkbox"/>	<input type="checkbox"/>	<input type="checkbox"/>	<input type="checkbox"/>	<input checked="" type="checkbox"/>

22 Any additional comments:

Some titles should be put in basic GCSE English!

THANK YOU FOR YOUR TIME

November Validation Feedback Sheet

Name:

*SECRET
Kumar*

Organisation:

Company K

Position:

*TECHNICAL
DIRECTOR*

Please tick one box on each line to show how far you agree with each statement.

		Strongly Agree	Agree	Neither	Disagree	Strongly disagree
1	Many major information flows and activities have been omitted in this model.		/			
2	This model displays the required information clearly.		/			
3	This model is an adequate representation of the remanufacturing business process		/			
4	I find many details in this model ambiguous			/		
5	This model does not reflect the remanufacturing business process to any great extent			/	/	
6	Only a few major activities and information flows have been omitted in this model			/		
7	This model is correct in the way that it shows the basic elements of the remanufacturing business process		/			
8	I find this model easy to comprehend		/			
9	I feel that this model captures the major information flows and activities of a remanufacturing business process		/			
10	I can analyse the information flows and activities of the remanufacturing business with this model		/			
11	Only a few major information flows and activities are missing in this model		/		/	

Name:

STUART
RANDALL

Organisation: Company K

Position:

TECHNICAL
DIRECTOR

Please tick one box on each line to show how far you agree with each statement.

		Strongly Agree	Agree	Neither	Disagree	Strongly disagree
12	This model is an acceptable description of the basic remanufacturing business process		✓			
13	This model requires many alterations before it can describe the remanufacturing business process				✓	
14	This model is extremely difficult to understand				✓	
15	I would not use this model to give a basic description of the remanufacturing business process				✓	
16	Generally, this model is logical in the way that it describes the remanufacturing business process		✓			
17	This model is a poor representation of the remanufacturing business process				✓	
18	I do not recognise this model as being that of the remanufacturing business process				✓	
19	I find this model easy to follow		✓			
20	I would consider using this model to describe the remanufacturing business process		✓			
21	Many major details are missing in this model				✓	

22 Any additional comments:

None

THANK YOU FOR YOUR TIME

November Validation Feedback Sheet

Name: JOHN Organisation: Company G
BATEMAN

Position: EDUC. MGR

Please tick one box on each line to show how far you agree with each statement.

		Strongly Agree	Agree	Neither	Disagree	Strongly disagree
1	Many major information flows and activities have been omitted in this model.					✓
2	This model displays the required information clearly.		✓			
3	This model is an adequate representation of the remanufacturing business process		✓		✓	
4	I find many details in this model ambiguous				✓	
5	This model does not reflect the remanufacturing business process to any great extent				✓	
6	Only a few major activities and information flows have been omitted in this model			✓		
	This model is correct in the way that it shows the basic elements of the remanufacturing business process		✓			
8	I find this model easy to comprehend		✓			
9	I feel that this model captures the major information flows and activities of a remanufacturing business process		✓			
10	I can analyse the information flows and activities of the remanufacturing business with this model		✓			
11	Only a few major information flows and activities are missing in this model				✓	

Name: JOHN BATEMAN Organisation: Company G

Position: Engineer
Manager

Please tick one box on each line to show how far you agree with each statement.

		Strongly Agree	Agree	Neither	Disagree	Strongly disagree
12	This model is an acceptable description of the basic remanufacturing business process		✓			
13	This model requires many alterations before it can describe the remanufacturing business process					✓
14	This model is extremely difficult to understand					✓
15	I would not use this model to give a basic description of the remanufacturing business process					✓
16	Generally, this model is logical in the way that it describes the remanufacturing business process		✓			
17	This model is a poor representation of the remanufacturing business process				/	
18	I do not recognise this model as being that of the remanufacturing business process					✓
19	I find this model easy to follow		✓			
20	I would consider using this model to describe the remanufacturing business process		✓			
21	Many major details are missing in this model					✓

22 Any additional comments:

THANK YOU FOR YOUR TIME

November Validation Feedback Sheet

Name: A.D. TANSLEY Organisation: Company B

Position: MD

Please tick one box on each line to show how far you agree with each statement.

		Strongly Agree	Agree	Neither	Disagree	Strongly disagree
1	Many major information flows and activities have been omitted in this model.					X
2	This model displays the required information clearly.		X			
3	This model is an adequate representation of the remanufacturing business process		X			
4	I find many details in this model ambiguous				X	
5	This model does not reflect the remanufacturing business process to any great extent					X
6	Only a few major activities and information flows have been omitted in this model		X			
7	This model is correct in the way that it shows the basic elements of the remanufacturing business process			X		
8	I find this model easy to comprehend		X			
9	I feel that this model captures the major information flows and activities of a remanufacturing business process		X			
10	I can analyse the information flows and activities of the remanufacturing business with this model		X			
11	Only a few major information flows and activities are missing in this model			X		

Name: AD TANSLEY Organisation: Company B Position: M.D

Please tick one box on each line to show how far you agree with each statement.

		Strongly Agree	Agree	Neither	Disagree	Strongly disagree
12	This model is an acceptable description of the basic remanufacturing business process			X		
13	This model requires many alterations before it can describe the remanufacturing business process				X	
14	This model is extremely difficult to understand				X	
15	I would not use this model to give a basic description of the remanufacturing business process				X	
16	Generally, this model is logical in the way that it describes the remanufacturing business process		X			
17	This model is a poor representation of the remanufacturing business process				X	
18	I do not recognise this model as being that of the remanufacturing business process				X	
19	I find this model easy to follow		X			
20	I would consider using this model to describe the remanufacturing business process		X			
21	Many major details are missing in this model				X	

22 Any additional comments:

THANK YOU FOR YOUR TIME

Validation Feedback sheet

Name: **ROLAND STRUBE** Organisation: **PROJECT MANAGER** Position: **WAMTEC UNI. SHEFF.**

please tick one box on each line to show how far you agree with each statement

Hidden text			Strongly Agree	Agree	Neither	Disagree	Strongly disagree
SF	1	Many major information flows and activities have been omitted in this model.		✓		✓	
C	2	This model displays the required information clearly.		✓			
ST	3	This model is an adequate representation of the remanufacturing business process		✓	✗		
C	4	I find many details in this model ambiguous				✓	
ST	5	This model does not reflect the remanufacturing business process to any great extent				✓	
SF	6	Only a few major activities and information flows have been omitted in this model		✓			
ST	7	This model is correct in the way that it shows the basic elements of the remanufacturing business process		✓			
C	8	I find this model easy to comprehend		✓			
SF	9	I feel that this model captures the major information flows and activities of a remanufacturing business process		✓			
C	10	I can analyse the information flows and activities of the remanufacturing business with this model		✓			
SF	11	Only a few major information flows and activities are missing in this model		✓			

CODE: C: Clarity; SF: Sufficiency; ST: Suitability

Name: R. STUBBE Organisation: SHEFFIELD UNIVERSITY

Position: Project Manager

Please tick one box on each line to show how far you agree with each statement.

<i>Hidden text</i>			Strongly Agree	Agree	Neither	Disagree	Strongly disagree
ST	12	This model is an acceptable description of the basic remanufacturing business process		✓			
SF	13	This model requires many alterations before it can describe the remanufacturing business process				✓	
C	14	This model is extremely difficult to understand				✓	
ST	15	I would not use this model to give a basic description of the remanufacturing business process				✓	
C	16	Generally, this model is logical in the way that it describes the remanufacturing business process		✓			
SF	17	This model is a poor representation of the remanufacturing business process				✓	✓
ST	18	I do not recognise this model as being that of the remanufacturing business process					✓
C	19	I find this model easy to follow		✓	✓		
ST	20	I would consider using this model to describe the remanufacturing business process		✓			
SF	21	Many major details are missing in this model					✓

22 Any additional comments:

THANK YOU FOR YOUR TIME

November Validation Feedback Sheet

Name: M. J. G. R. H. Organisation: Company H

Position: M.D

Please tick one box on each line to show how far you agree with each statement.

		Strongly Agree	Agree	Neither	Disagree	Strongly disagree
1	Many major information flows and activities have been omitted in this model.				✓	
2	This model displays the required information clearly.		✓			
3	This model is an adequate representation of the remanufacturing business process	✓				
4	I find many details in this model ambiguous					✓
5	This model does not reflect the remanufacturing business process to any great extent				✓	
6	Only a few major activities and information flows have been omitted in this model				✓	
	This model is correct in the way that it shows the basic elements of the remanufacturing business process	✓				
8	I find this model easy to comprehend	✓				
9	I feel that this model captures the major information flows and activities of a remanufacturing business process		✓			
10	I can analyse the information flows and activities of the remanufacturing business with this model		✓			
11	Only a few major information flows and activities are missing in this model				✓	

Name: *MJS GREEN* Organisation: *Company H* Position: *M.D*

Please tick one box on each line to show how far you agree with each statement.

		Strongly Agree	Agree	Neither	Disagree	Strongly disagree
12	This model is an acceptable description of the basic remanufacturing business process		✓			
13	This model requires many alterations before it can describe the remanufacturing business process				✓	
14	This model is extremely difficult to understand				✓	
15	I would not use this model to give a basic description of the remanufacturing business process					✓
16	Generally, this model is logical in the way that it describes the remanufacturing business process		✓			
17	This model is a poor representation of the remanufacturing business process				✓	
18	I do not recognise this model as being that of the remanufacturing business process				✓	
19	I find this model easy to follow	✓				
20	I would consider using this model to describe the remanufacturing business process		✓			
21	Many major details are missing in this model				✓	

22 Any additional comments:

THANK YOU FOR YOUR TIME

Completed secondary feedback sheets

Validation Feedback Sheet (Node A-0)

Name: L. ALLMAN Organisation: De Montfort University position: Researcher

Please complete the following boxes

1. Do you believe that the model used today describes the remanufacturing business process.
(please tick)

Strongly agree

Agree

Neither

Disagree

Strongly disagree

2. Are there any areas of the model that you believe are specific only to a small group of companies. (Continue on a separate sheet or return the diagrams with comments if necessary).

No

3. If the model was not complete, what are the exceptions?

There needs to be further description of the reverse chain logistics of obtaining cores, either by a separate diagram leading into \rightarrow A0 (*) or by more detail in All by cores 2(A)

4. Are there any areas of the model that you believe are unclear to use (Continue on a separate sheet or return the diagrams with comments if necessary).

THANK YOU FOR YOUR TIME

Validation Feedback Sheet (Node A0)

Name: L. Allman Organisation: DeMontfort University position: Researcher

Please complete the following boxes

1. Do you believe that the model used today describes the remanufacturing business process.
(please tick)

Strongly agree

Agree

Neither

Disagree

Strongly disagree

2. Are there any areas of the model that you believe are specific only to a small group of companies. (Continue on a separate sheet or return the diagrams with comments if necessary).

No

3. If the model was not complete, what are the exceptions?

- Could be more detail about the relationship between OEM and remanufacturers. ie they can be the customer and supplier.
- There will be specific contracts between remanufacturers and their customers and the OEM, which will relate to specification of the product.

4. Are there any areas of the model that you believe are unclear to use (Continue on a separate sheet or return the diagrams with comments if necessary).

THANK YOU FOR YOUR TIME

Validation Feedback Sheet (Node A1)

Name: L. Allman Organisation: De Montfort University position: Researcher

Please complete the following boxes

1. Do you believe that the model used today describes the remanufacturing business process.
(please tick)

Strongly agree

Agree

Neither

Disagree

Strongly disagree

2. Are there any areas of the model that you believe are specific only to a small group of companies. (Continue on a separate sheet or return the diagrams with comments if necessary).

No

3. If the model was not complete, what are the exceptions?

Box A112 needs to go to one or more levels of complexity, ie what is the core market
- Needs to be a new box between A11 and A12. which ~~was~~ should be a preliminary. Check on core quality when the core arrives at the factory

4. Are there any areas of the model that you believe are unclear to use (Continue on a separate sheet or return the diagrams with comments if necessary).

THANK YOU FOR YOUR TIME

Validation Feedback Sheet (Node A11)

Name: L. Allman Organisation: DeMontfort University position: Researcher

Please complete the following boxes

1. Do you believe that the model used today describes the remanufacturing business process.
(please tick)

Strongly agree

Agree

Neither

Disagree

Strongly disagree

2. Are there any areas of the model that you believe are specific only to a small group of companies. (Continue on a separate sheet or return the diagrams with comments if necessary).

No

3. If the model was not complete, what are the exceptions?

Box A112 could have a more detailed description of the buying of core procedure, ie who are you buying it from what are the limiting factors

4. Are there any areas of the model that you believe are unclear to use (Continue on a separate sheet or return the diagrams with comments if necessary).

THANK YOU FOR YOUR TIME

Validation Feedback Sheet (Node A2)

Name: L Allman Organisation: De Montfort University position:

Please complete the following boxes

1. Do you believe that the model used today describes the remanufacturing business process.
(please tick)

Strongly agree

Agree

Neither

Disagree

Strongly disagree

2. Are there any areas of the model that you believe are specific only to a small group of companies. (Continue on a separate sheet or return the diagrams with comments if necessary).

No

3. If the model was not complete, what are the exceptions?

Experience should be replaced by Documentation and Training.

Company policy should be replaced with Continuous Improvement or Quality Std and customer Specification

4. Are there any areas of the model that you believe are unclear to use (Continue on a separate sheet or return the diagrams with comments if necessary).

THANK YOU FOR YOUR TIME

Validation Feedback Sheet (Node A2)

A22

Name: L. Rittman Organisation: De Montfort University position:

Please complete the following boxes

1. Do you believe that the model used today describes the remanufacturing business process. (please tick)

Strongly agree

Agree

Neither

Disagree

Strongly disagree

2. Are there any areas of the model that you believe are specific only to a small group of companies. (Continue on a separate sheet or return the diagrams with comments if necessary).

No

3. If the model was not complete, what are the exceptions?

"work assessment sheet" is too vague, should be called "Component History Document",
Box A22 should be renamed "Identify Core"

4. Are there any areas of the model that you believe are unclear to use (Continue on a separate sheet or return the diagrams with comments if necessary).

THANK YOU FOR YOUR TIME

Validation Feedback Sheet (Node A23)

Name: L Allman Organisation: De Montfort University position:

Please complete the following boxes

1. Do you believe that the model used today describes the remanufacturing business process.
(please tick)

Strongly agree

Agree

Neither

Disagree

Strongly disagree

2. Are there any areas of the model that you believe are specific only to a small group of companies. (Continue on a separate sheet or return the diagrams with comments if necessary).

No

3. If the model was not complete, what are the exceptions?

- Bring parts to current spec is misleading
Should read bring parts to "fit for
purpose" or to "Customer Specifications"

4. Are there any areas of the model that you believe are unclear to use (Continue on a separate sheet or return the diagrams with comments if necessary).

THANK YOU FOR YOUR TIME

Validation Feedback Sheet (Node A-0)

Name: J RATHERN Organisation: Company G position: LONG VIEW

Please complete the following boxes

1. Do you believe that the model used today describes the remanufacturing business process.
(please tick)

Strongly agree

Agree

Neither

Disagree

Strongly disagree

2. Are there any areas of the model that you believe are specific only to a small group of companies. (Continue on a separate sheet or return the diagrams with comments if necessary).

Industry standards linked to obtain in articles.

3. If them model was not complete, what are the exceptions?

4. Are there any areas of the model that you believe are unclear to use (Continue on a separate sheet or return the diagrams with comments if necessary).

THANK YOU FOR YOUR TIME

Validation Feedback Sheet (Node A11)

Name: *JWAH*

Organisation: *Company G* position:

Please complete the following boxes

1. Do you believe that the model used today describes the remanufacturing business process.
(please tick)

Strongly agree

Agree

Neither

Disagree

Strongly disagree

2. Are there any areas of the model that you believe are specific only to a small group of companies. (Continue on a separate sheet or return the diagrams with comments if necessary).

3. If them model was not complete, what are the exceptions?

Expand on titles

<i>Experience</i>
<i>Forecast</i>
<i>etc.</i>

4. Are there any areas of the model that you believe are unclear to use (Continue on a separate sheet or return the diagrams with comments if necessary).

THANK YOU FOR YOUR TIME

Validation Feedback Sheet (Node A2)

Name: *J. Bateman* Organisation: *Company G* position:

Please complete the following boxes

1. Do you believe that the model used today describes the remanufacturing business process.
(please tick)

Strongly agree

Agree

Neither

Disagree

Strongly disagree

2. Are there any areas of the model that you believe are specific only to a small group of companies. (Continue on a separate sheet or return the diagrams with comments if necessary).

3. If the model was not complete, what are the exceptions?

Preparation before strip core

Test Fail to Rework Area.

4. Are there any areas of the model that you believe are unclear to use (Continue on a separate sheet or return the diagrams with comments if necessary).

THANK YOU FOR YOUR TIME

Validation Feedback Sheet (Node A23)

Name: JOHN
MACKIE Organisation: Company J position: MD

Please complete the following boxes

1. Do you believe that the model used today describes the remanufacturing business process.
(please tick)

Strongly agree

Agree

Neither

Disagree

Strongly disagree

2. Are there any areas of the model that you believe are specific only to a small group of companies. (Continue on a separate sheet or return the diagrams with comments if necessary).

3. If them model was not complete, what are the exceptions?

4. Are there any areas of the model that you believe are unclear to use (Continue on a separate sheet or return the diagrams with comments if necessary).

THANK YOU FOR YOUR TIME

Validation Feedback Sheet (Node A233)

Name: **JOHN MAEKIG** Organisation: **Company J** position: **MD**

Please complete the following boxes

1. Do you believe that the model used today describes the remanufacturing business process.
(please tick)

Strongly agree

Agree

Neither

Disagree

Strongly disagree

2. Are there any areas of the model that you believe are specific only to a small group of companies. (Continue on a separate sheet or return the diagrams with comments if necessary).

3. If the model was not complete, what are the exceptions?

4. Are there any areas of the model that you believe are unclear to use (Continue on a separate sheet or return the diagrams with comments if necessary).

THANK YOU FOR YOUR TIME

Validation Feedback Sheet (Node A0)

Name: John Mackie Organisation: Company J position: MD

Please complete the following boxes

1. Do you believe that the model used today describes the remanufacturing business process.
(please tick)

Strongly agree

Agree

Neither

Disagree

Strongly disagree

2. Are there any areas of the model that you believe are specific only to a small group of companies. (Continue on a separate sheet or return the diagrams with comments if necessary).

3. If them model was not complete, what are the exceptions?

4. Are there any areas of the model that you believe are unclear to use (Continue on a separate sheet or return the diagrams with comments if necessary).

THANK YOU FOR YOUR TIME

Validation Feedback Sheet (Node A1)

Name: ^{John}
MACKIK

Organisation: Company G position:

MA

Please complete the following boxes

1. Do you believe that the model used today describes the remanufacturing business process.
(please tick)

Strongly agree

Agree

Neither

Disagree

Strongly disagree

2. Are there any areas of the model that you believe are specific only to a small group of companies. (Continue on a separate sheet or return the diagrams with comments if necessary).

3. If them model was not complete, what are the exceptions?

4. Are there any areas of the model that you believe are unclear to use (Continue on a separate sheet or return the diagrams with comments if necessary).

THANK YOU FOR YOUR TIME

Validation Feedback Sheet (Node A11)

Name: **JOHN
MACKIE**

Organisation: **Company G** position: **MD**

Please complete the following boxes

1. Do you believe that the model used today describes the remanufacturing business process.
(please tick)

Strongly agree

Agree

Neither

Disagree

Strongly disagree

2. Are there any areas of the model that you believe are specific only to a small group of companies. (Continue on a separate sheet or return the diagrams with comments if necessary).

3. If them model was not complete, what are the exceptions?

4. Are there any areas of the model that you believe are unclear to use (Continue on a separate sheet or return the diagrams with comments if necessary).

THANK YOU FOR YOUR TIME

Validation Feedback Sheet (Node A2)

Name: **JOHN MACKIE** Organisation: **Company G** position: **MD**

Please complete the following boxes

1. Do you believe that the model used today describes the remanufacturing business process.
(please tick)

Strongly agree

Agree

Neither

Disagree

Strongly disagree

2. Are there any areas of the model that you believe are specific only to a small group of companies. *(Continue on a separate sheet or return the diagrams with comments if necessary).*

3. If them model was not complete, what are the exceptions?

4. Are there any areas of the model that you believe are unclear to use *(Continue on a separate sheet or return the diagrams with comments if necessary).*

THANK YOU FOR YOUR TIME

Validation Feedback Sheet (Node A21)

Name: John Mockie Organisation: Company Position: MA

Please complete the following boxes

1. Do you believe that the model used today describes the remanufacturing business process.
(please tick)

Strongly agree

Agree

Neither

Disagree

Strongly disagree

2. Are there any areas of the model that you believe are specific only to a small group of companies. (Continue on a separate sheet or return the diagrams with comments if necessary).

3. If the model was not complete, what are the exceptions?

4. Are there any areas of the model that you believe are unclear to use (Continue on a separate sheet or return the diagrams with comments if necessary).

THANK YOU FOR YOUR TIME

Validation Feedback Sheet (Node A0)

Name: h. Randall Organisation: Company K position:

Please complete the following boxes

1. Do you believe that the model used today describes the remanufacturing business process.
(please tick)

Strongly agree

Agree

Neither

Disagree

Strongly disagree

2. Are there any areas of the model that you believe are specific only to a small group of companies. (Continue on a separate sheet or return the diagrams with comments if necessary).

No - ALL AREA'S ARE SUITABLE
FOR ALL CO'S
ONLY "DETAIL" WOULD CHANGE
LARGE + SMALL

3. If the model was not complete, what are the exceptions?

REGISLATION AS A SEPERATE
CONTROL

4. Are there any areas of the model that you believe are unclear to use (Continue on a separate sheet or return the diagrams with comments if necessary).

No

THANK YOU FOR YOUR TIME

Validation Feedback Sheet (Node A0)

Name:

Organisation: *Company*
K

position:

Please complete the following boxes

1. Do you believe that the model used today describes the remanufacturing business process.
(please tick)

Strongly agree

Agree

Neither

Disagree

Strongly disagree

2. Are there any areas of the model that you believe are specific only to a small group of companies. (Continue on a separate sheet or return the diagrams with comments if necessary).

3. If the model was not complete, what are the exceptions?

*work not necessarily done
from sale's enquiry
we would re-manufacture without
sale enquiry + hope to sell after*

4. Are there any areas of the model that you believe are unclear to use (Continue on a separate sheet or return the diagrams with comments if necessary).

THANK YOU FOR YOUR TIME

Validation Feedback Sheet (Node A1)

Name:

Organisation: *Company*
K

position:

Please complete the following boxes

1. Do you believe that the model used today describes the remanufacturing business process.
(please tick)

Strongly agree

Agree

Neither

Disagree

Strongly disagree

2. Are there any areas of the model that you believe are specific only to a small group of companies. (Continue on a separate sheet or return the diagrams with comments if necessary).

3. If them model was not complete, what are the exceptions?

4. Are there any areas of the model that you believe are unclear to use (Continue on a separate sheet or return the diagrams with comments if necessary).

Show how many decomposition levels through shading etc.

THANK YOU FOR YOUR TIME

Validation Feedback Sheet (Node A11)

Name:

Organisation: *Company*
K

position:

Please complete the following boxes

1. Do you believe that the model used today describes the remanufacturing business process.
(please tick)

Strongly agree

Agree

Neither

Disagree

Strongly disagree

2. Are there any areas of the model that you believe are specific only to a small group of companies. (Continue on a separate sheet or return the diagrams with comments if necessary).

3. If them model was not complete, what are the exceptions?

4. Are there any areas of the model that you believe are unclear to use (Continue on a separate sheet or return the diagrams with comments if necessary).

The controls should be clarified or dictionaryed in some way.

THANK YOU FOR YOUR TIME

Validation Feedback Sheet (Node A2)

Name:

Organisation: *Company K* position:

Please complete the following boxes

1. Do you believe that the model used today describes the remanufacturing business process.
(please tick)

Strongly agree

Agree

Neither

Disagree

Strongly disagree

2. Are there any areas of the model that you believe are specific only to a small group of companies. (Continue on a separate sheet or return the diagrams with comments if necessary).

*each model would
be customised*

3. If the model was not complete, what are the exceptions?

*PIU - processing missing
before Strip core
waste or including in
scrap/Recycle*

4. Are there any areas of the model that you believe are unclear to use (Continue on a separate sheet or return the diagrams with comments if necessary).

*rework should have a
separate box looped into
test or finished*

THANK YOU FOR YOUR TIME

Validation Feedback Sheet (Node A21)

Name:

Organisation: *Company K* position:

Please complete the following boxes

1. Do you believe that the model used today describes the remanufacturing business process. (please tick)

Strongly agree

Agree

Neither

Disagree

Strongly disagree

2. Are there any areas of the model that you believe are specific only to a small group of companies. (Continue on a separate sheet or return the diagrams with comments if necessary).

~~each model must be~~
~~customised~~

3. If the model was not complete, what are the exceptions?

new word title of disassemble
cone —

4. Are there any areas of the model that you believe are unclear to use (Continue on a separate sheet or return the diagrams with comments if necessary).

~~good as old of the use~~
~~a box for the~~
~~of the product~~

THANK YOU FOR YOUR TIME

Validation Feedback Sheet (Node A22)

Name:

Organisation: *Company K* position:

Please complete the following boxes

1. Do you believe that the model used today describes the remanufacturing business process. (please tick)

Strongly agree

Agree

Neither

Disagree

Strongly disagree

rethink - bin name

2. Are there any areas of the model that you believe are specific only to a small group of companies. (Continue on a separate sheet or return the diagrams with comments if necessary).

~~Disassembled~~ *A234 materials*
Scrap = Recyclable = all
Recyclable Materials go to Recyclable bin =

3. If them model was not complete, what are the exceptions?

change visually to preliminary inspection

4. Are there any areas of the model that you believe are unclear to use (Continue on a separate sheet or return the diagrams with comments if necessary).

THANK YOU FOR YOUR TIME

Validation Feedback Sheet (Node A0)

Name:
Sumit Kumar

Organisation: Company K

position:
Technical
director

Please complete the following boxes

1. Do you believe that the model used today describes the remanufacturing business process.
(please tick)

Strongly agree

Agree

Neither

Disagree

Strongly disagree

2. Are there any areas of the model that you believe are specific only to a small group of companies. (Continue on a separate sheet or return the diagrams with comments if necessary).

3. If the model was not complete, what are the exceptions?

legislation as Controller into remanufacturing products.

4. Are there any areas of the model that you believe are unclear to use (Continue on a separate sheet or return the diagrams with comments if necessary). No

THANK YOU FOR YOUR TIME

Validation Feedback Sheet (Node A1)

Name:

Organisation: *Company K* position:

Please complete the following boxes

1. Do you believe that the model used today describes the remanufacturing business process.
(please tick)

Strongly agree

Agree

Neither

Disagree

Strongly disagree

2. Are there any areas of the model that you believe are specific only to a small group of companies. (Continue on a separate sheet or return the diagrams with comments if necessary).

3. If the model was not complete, what are the exceptions?

Customizing for individual companies

4. Are there any areas of the model that you believe are unclear to use (Continue on a separate sheet or return the diagrams with comments if necessary).

No - learn correct method of reading

THANK YOU FOR YOUR TIME

Validation Feedback Sheet (Node A2)

Name:

Organisation: *Company K* position:

Please complete the following boxes

1. Do you believe that the model used today describes the remanufacturing business process.
(please tick)

Strongly agree

Agree

Neither

Disagree

Strongly disagree

2. Are there any areas of the model that you believe are specific only to a small group of companies. (Continue on a separate sheet or return the diagrams with comments if necessary).

3. If them model was not complete, what are the exceptions?

4. Are there any areas of the model that you believe are unclear to use (Continue on a separate sheet or return the diagrams with comments if necessary).

THANK YOU FOR YOUR TIME

Validation Feedback Sheet (Node A0)

Name:

A. TESTA

Organisation:

Company F

position:

C.M

Please complete the following boxes

1. Do you believe that the model used today describes the remanufacturing business process. (please tick)

Strongly agree

Agree

Neither

Disagree

Strongly disagree

2. Are there any areas of the model that you believe are specific only to a small group of companies. (Continue on a separate sheet or return the diagrams with comments if necessary).

As discussed at meeting with

3. If the model was not complete, what are the exceptions?

/

4. Are there any areas of the model that you believe are unclear to use (Continue on a separate sheet or return the diagrams with comments if necessary).

/

No

THANK YOU FOR YOUR TIME

Validation Feedback Sheet (Node A1)

Name:

A. TESTA

Organisation:

Company F

position:

CM

Please complete the following boxes

1. Do you believe that the model used today describes the remanufacturing business process.
(please tick)

Strongly agree

Agree

Neither

Disagree

Strongly disagree

2. Are there any areas of the model that you believe are specific only to a small group of companies. (Continue on a separate sheet or return the diagrams with comments if necessary).

3. If them model was not complete, what are the exceptions?

4. Are there any areas of the model that you believe are unclear to use (Continue on a separate sheet or return the diagrams with comments if necessary).

NO

THANK YOU FOR YOUR TIME

Validation Feedback Sheet (Node A11)

Name:

A TESTA

Organisation:

Company F

position:

C.M.

Please complete the following boxes

1. Do you believe that the model used today describes the remanufacturing business process.
(please tick)

Strongly agree

Agree

Neither

Disagree

Strongly disagree

2. Are there any areas of the model that you believe are specific only to a small group of companies. (Continue on a separate sheet or return the diagrams with comments if necessary).

3. If them model was not complete, what are the exceptions?

4. Are there any areas of the model that you believe are unclear to use (Continue on a separate sheet or return the diagrams with comments if necessary).

NO

THANK YOU FOR YOUR TIME

Validation Feedback Sheet (Node A2)

Name:

A TATA

Organisation:

Company F

position:

GM

Please complete the following boxes

1. Do you believe that the model used today describes the remanufacturing business process.
(please tick)

Strongly agree

Agree

Neither

Disagree

Strongly disagree

2. Are there any areas of the model that you believe are specific only to a small group of companies. (Continue on a separate sheet or return the diagrams with comments if necessary).

3. If them model was not complete, what are the exceptions?

4. Are there any areas of the model that you believe are unclear to use (Continue on a separate sheet or return the diagrams with comments if necessary).

No

THANK YOU FOR YOUR TIME

Validation Feedback Sheet (Node A21)

Name:

A TESTA

Organisation:

Company F

position:

CM

Please complete the following boxes

1. Do you believe that the model used today describes the remanufacturing business process.
(please tick)

Strongly agree

Agree

Neither

Disagree

Strongly disagree

2. Are there any areas of the model that you believe are specific only to a small group of companies. (Continue on a separate sheet or return the diagrams with comments if necessary).

3. If them model was not complete, what are the exceptions?

4. Are there any areas of the model that you believe are unclear to use (Continue on a separate sheet or return the diagrams with comments if necessary).

NO

THANK YOU FOR YOUR TIME

Validation Feedback Sheet (Node A22)

Name:

A TESTA

Organisation:

Company F

position:

CM

Please complete the following boxes

1. Do you believe that the model used today describes the remanufacturing business process.
(please tick)

Strongly agree

Agree

Neither

Disagree

Strongly disagree

2. Are there any areas of the model that you believe are specific only to a small group of companies. (Continue on a separate sheet or return the diagrams with comments if necessary).

3. If the model was not complete, what are the exceptions?

4. Are there any areas of the model that you believe are unclear to use (Continue on a separate sheet or return the diagrams with comments if necessary).

NO

THANK YOU FOR YOUR TIME

Validation Feedback Sheet (Node A23)

Name:

A TESTA

Organisation:

Company F

position:

CM

Please complete the following boxes

1. Do you believe that the model used today describes the remanufacturing business process.
(please tick)

Strongly agree

Agree

Neither

Disagree

Strongly disagree

2. Are there any areas of the model that you believe are specific only to a small group of companies. (Continue on a separate sheet or return the diagrams with comments if necessary).

3. If them model was not complete, what are the exceptions?

4. Are there any areas of the model that you believe are unclear to use (Continue on a separate sheet or return the diagrams with comments if necessary).

NO

THANK YOU FOR YOUR TIME

Validation Feedback Sheet (Node A233)

Name:

ATESTA

Organisation:

Company
F

position:

GM

Please complete the following boxes

1. Do you believe that the model used today describes the remanufacturing business process.
(please tick)

Strongly agree

Agree

Neither

Disagree

Strongly disagree

2. Are there any areas of the model that you believe are specific only to a small group of companies. (Continue on a separate sheet or return the diagrams with comments if necessary).

As discussed at Presentation

3. If the model was not complete, what are the exceptions?

As above

4. Are there any areas of the model that you believe are unclear to use (Continue on a separate sheet or return the diagrams with comments if necessary).

No

THANK YOU FOR YOUR TIME

7 The Biffawards

Details of the £80,000 Biffawards given to continue the remanufacturing research

From: "Stuart Randall" <randall@darppdrive.freemove.co.uk>

To: "Winnie Ijomah" <W.Ijomah@plymouth.ac.uk>

Subject: Biffaward

Date sent: Thu, 5 Apr 2001 16:36:39 +0100

Dear Winnie

Biffa Waste Services and the RSNC Biffaward would be very interested in funding Remanufacturing Research. They recognised the importance of your work and your expertise.

They do not feel this project should be incorporated into our demonstration project, because it is worthy to stand on its own. They feel that the best way forward would be to apply for the funding via Plymouth Universities Entrust approved Environmental Body (Steve Childes should know all about this), whereby DARP will become the Project Consultants undertaking the research, while working in partnership with Plymouth University, who will undertake the management of the fund, dissemination and reporting, etc.

We are looking at a grant of £80,000, for 12 months.

8 The validated generic model

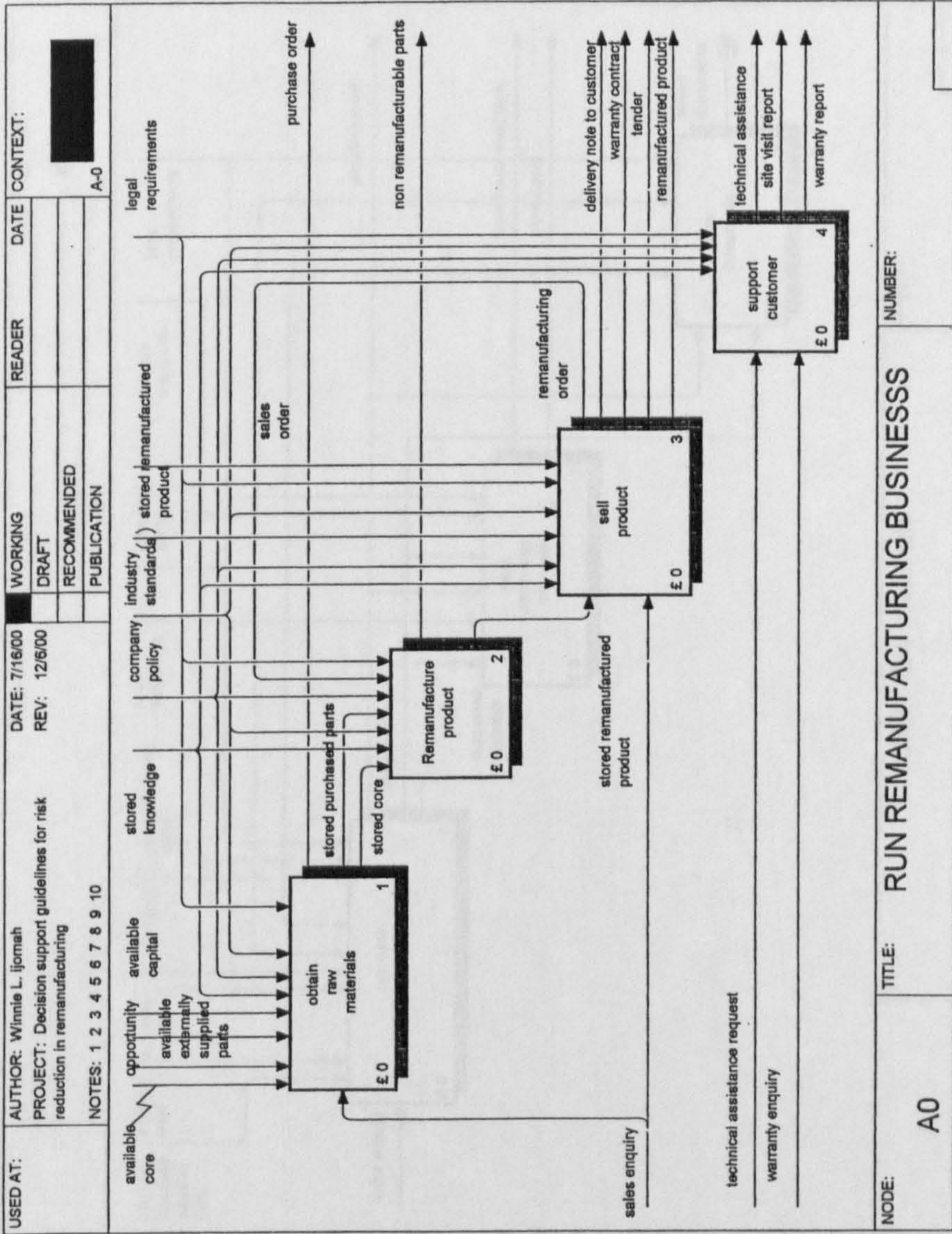

NUMBER: RUN REMANUFACTURING BUSINESS

TITLE:

A0

NODE:

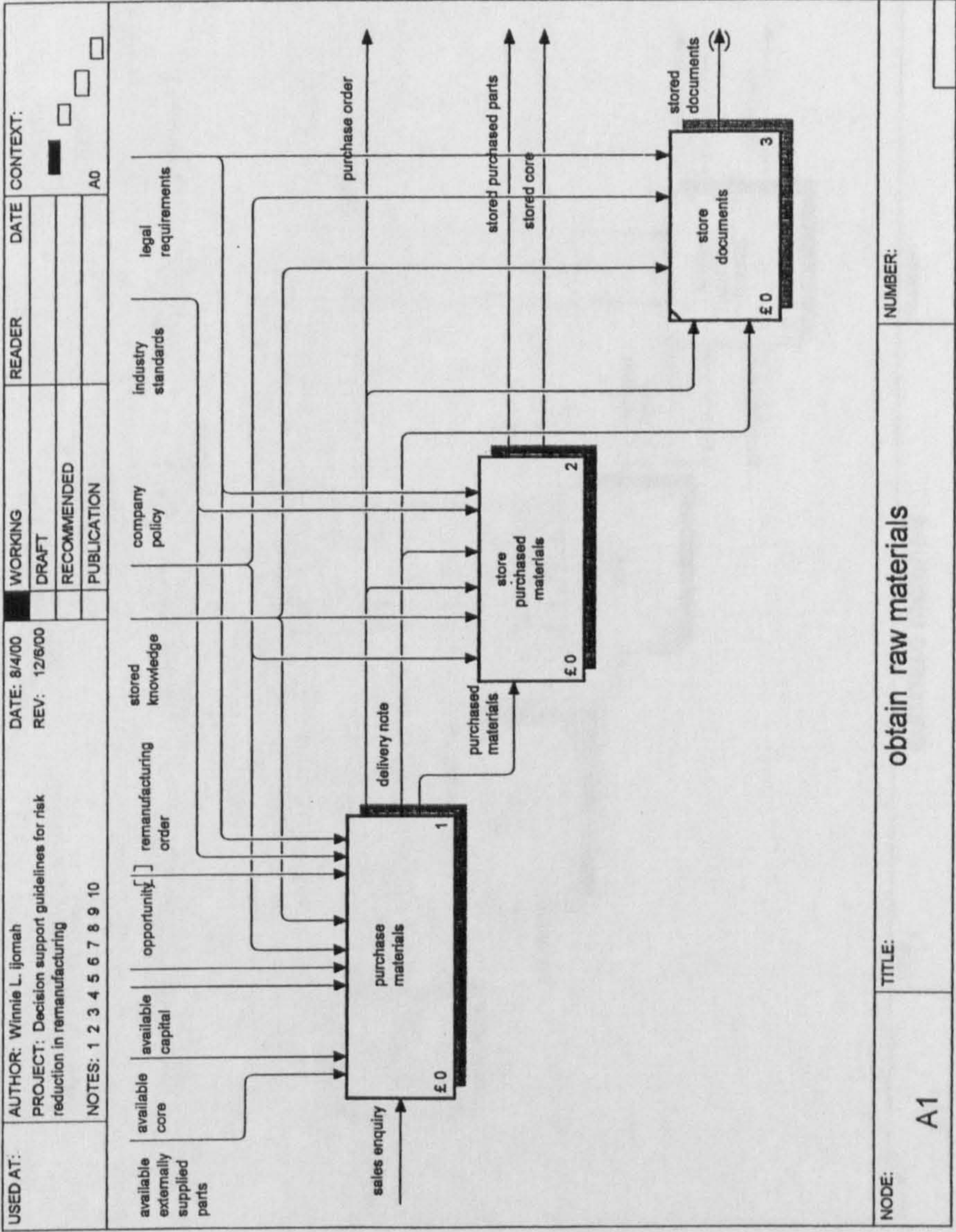

NODE:

A1

TITLE:

obtain raw materials

NUMBER:

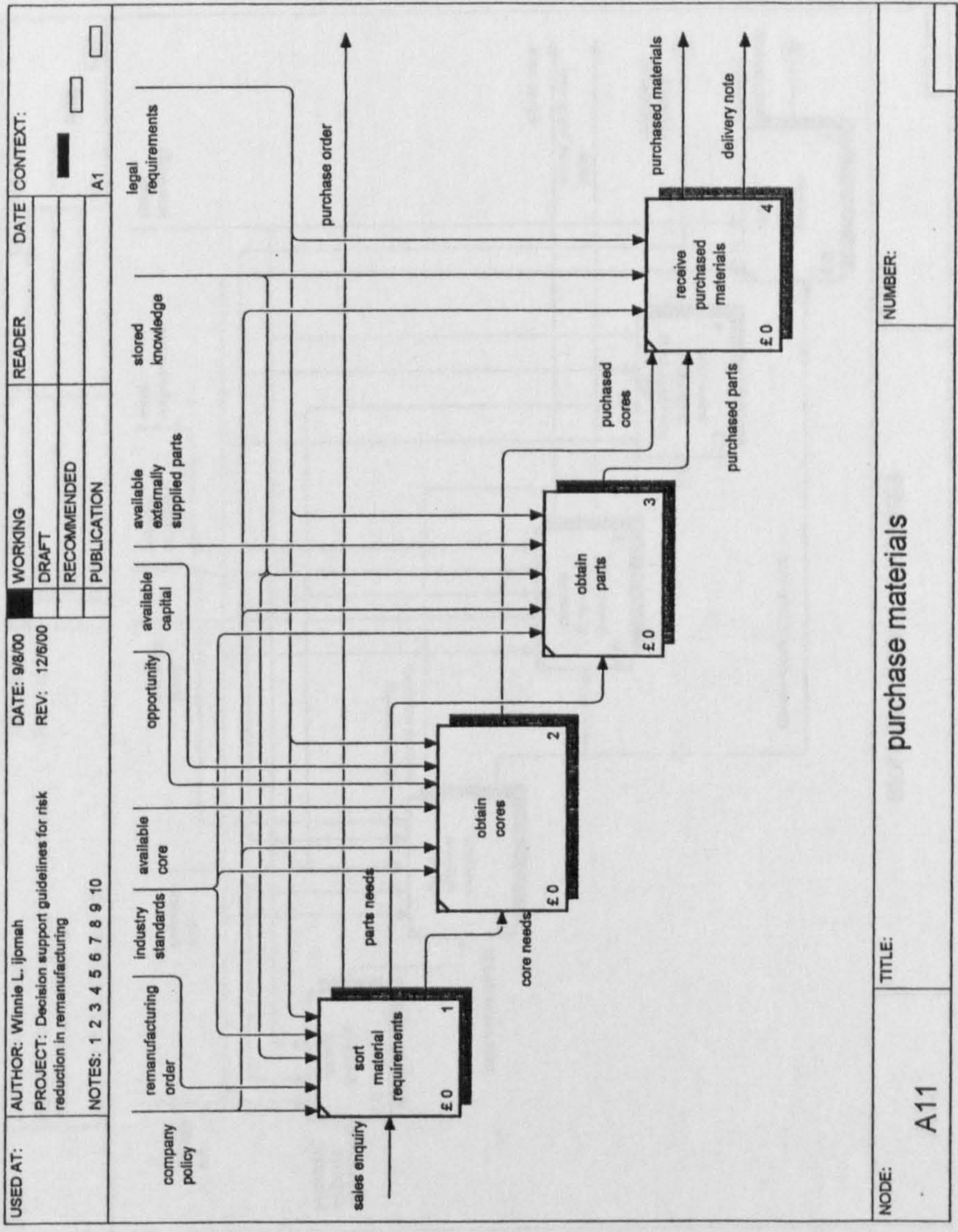

NODE: A11

TITLE: purchase materials

NUMBER:

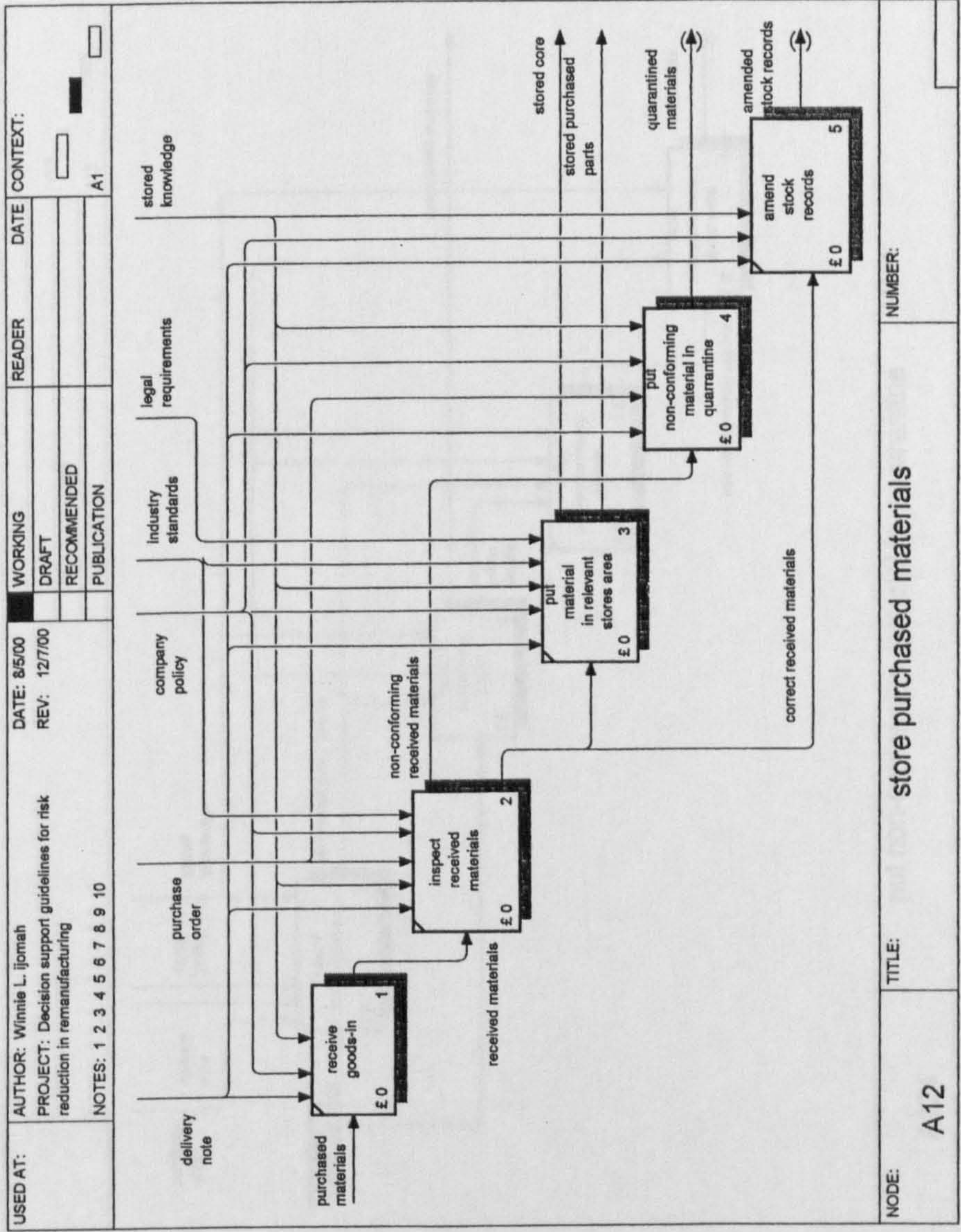

NODE: A12

TITLE: store purchased materials

NUMBER:

USED AT:	AUTHOR: Winnie L. Ijomah	DATE: 8/8/00	WORKING	READER	DATE	CONTEXT:
	PROJECT: Decision support guidelines for risk reduction in remanufacturing	REV: 12/7/00	DRAFT			
	NOTES: 1 2 3 4 5 6 7 8 9 10		RECOMMENDED			
			PUBLICATION			A12

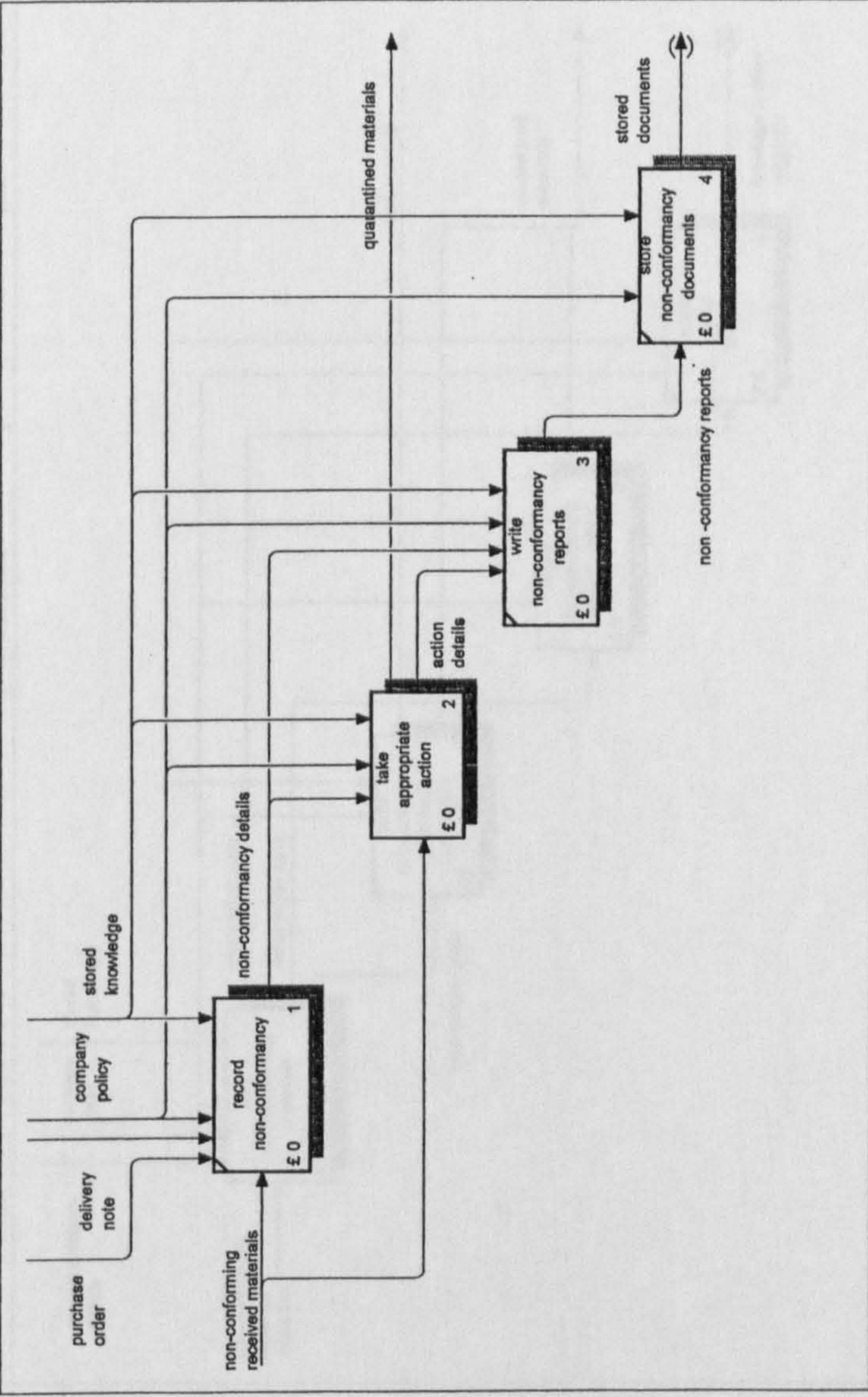

NODE:	A124	TITLE:	put non-conforming material in quarantine	NUMBER:	
-------	------	--------	---	---------	--

USED AT:	AUTHOR: Wimmie L. Ijomah	DATE: 8/8/00	WORKING	READER	DATE	CONTEXT:
	PROJECT: Decision support guidelines for risk reduction in remanufacturing	REV: 12/7/00	DRAFT			
	NOTES: 1 2 3 4 5 6 7 8 9 10		RECOMMENDED			A124
			PUBLICATION			

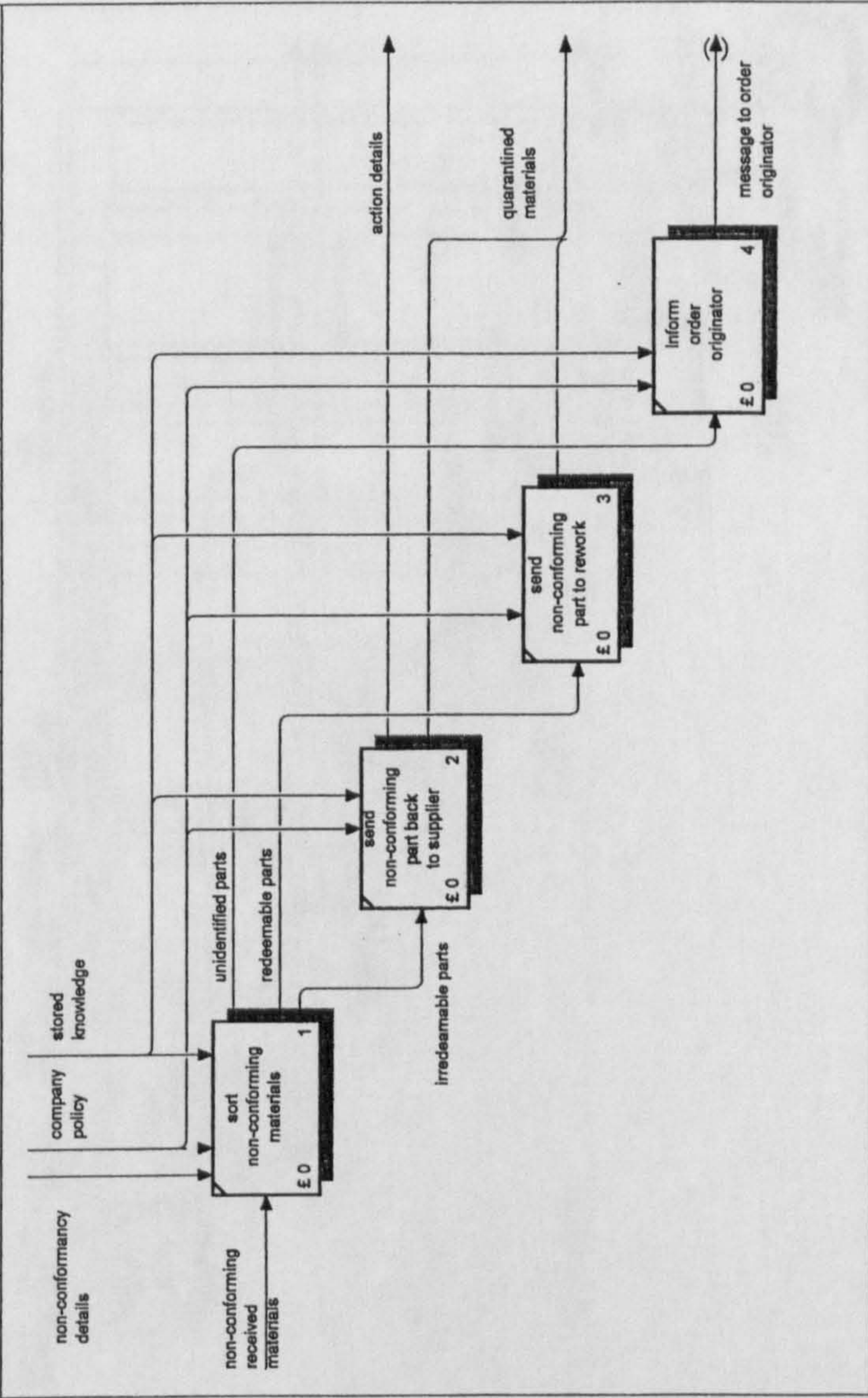

NODE: A1242	TITLE: take appropriate action	NUMBER:
-------------	--------------------------------	---------

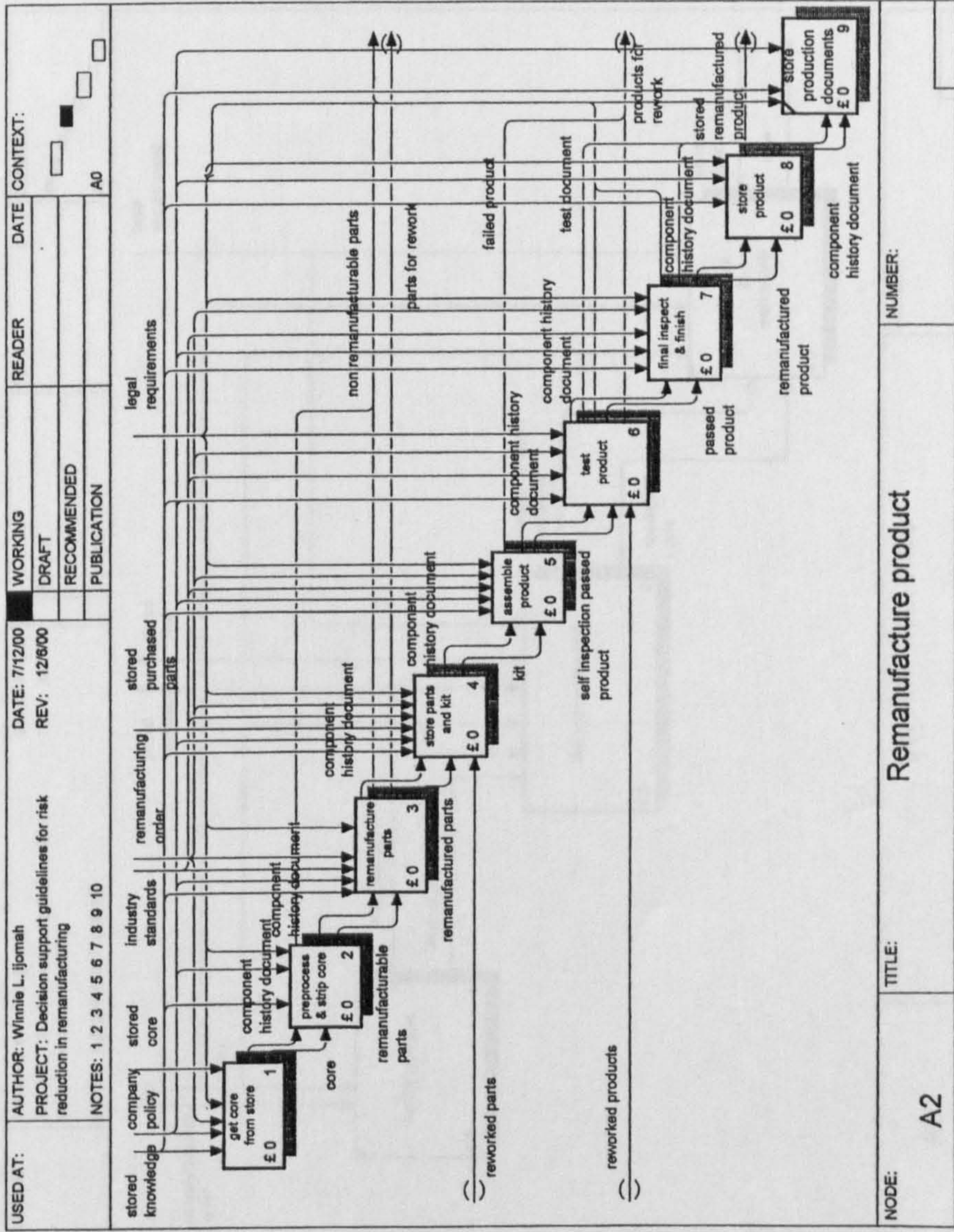

NODE: A2

TITLE: Remanufacture product

NUMBER:

USED AT:	AUTHOR: Winnie L. Ijomah	DATE: 7/13/00	WORKING	READER	DATE	CONTEXT:
	PROJECT: Decision support guidelines for risk reduction in remanufacturing	REV: 12/6/00	DRAFT			<input type="checkbox"/> <input type="checkbox"/> <input type="checkbox"/> <input type="checkbox"/> <input type="checkbox"/> <input type="checkbox"/> <input type="checkbox"/>
	NOTES: 1 2 3 4 5 6 7 8 9 10		RECOMMENDED			A2
			PUBLICATION			

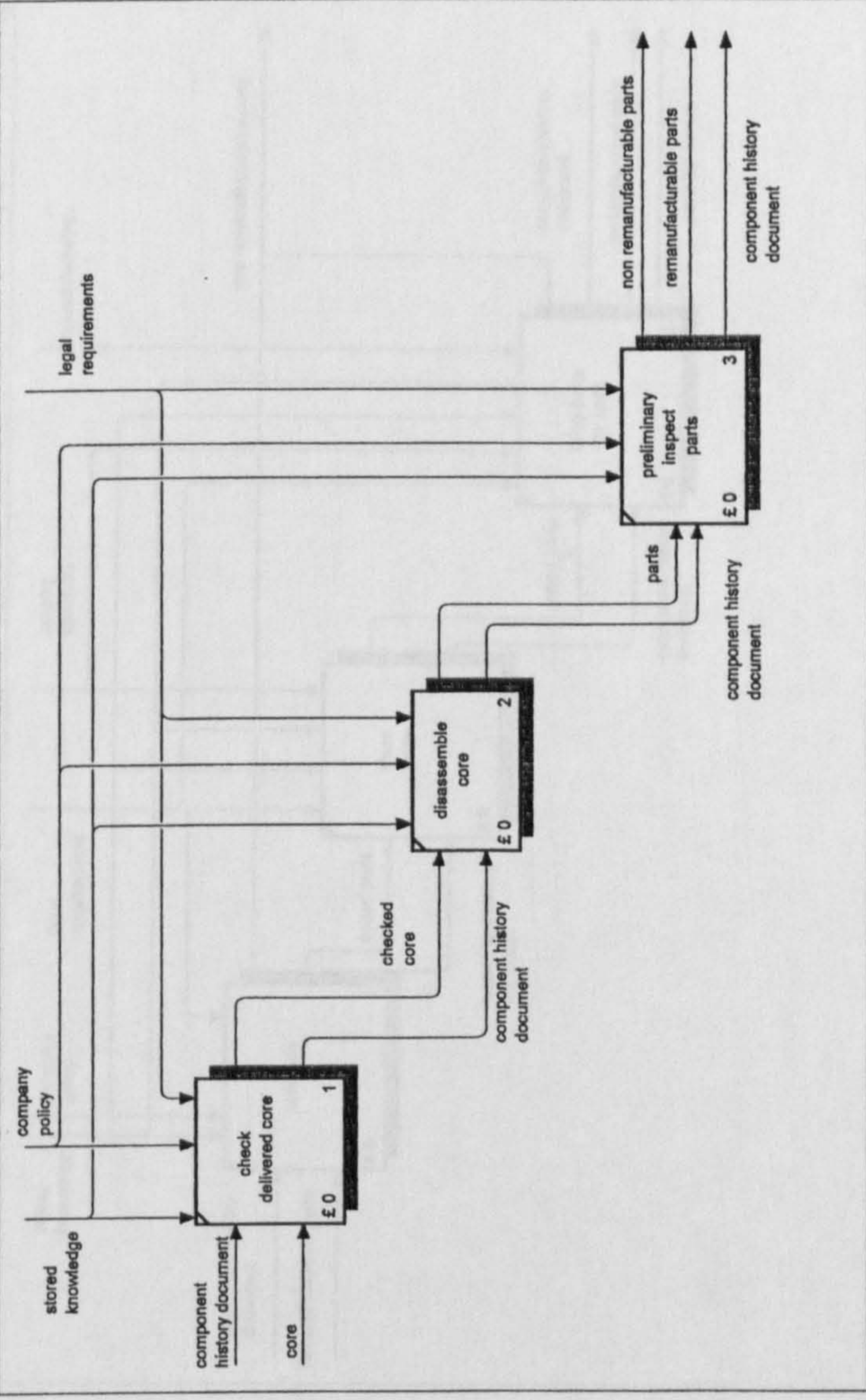

NODE: A22	TITLE: preprocess & strip core	NUMBER:
-----------	--------------------------------	---------

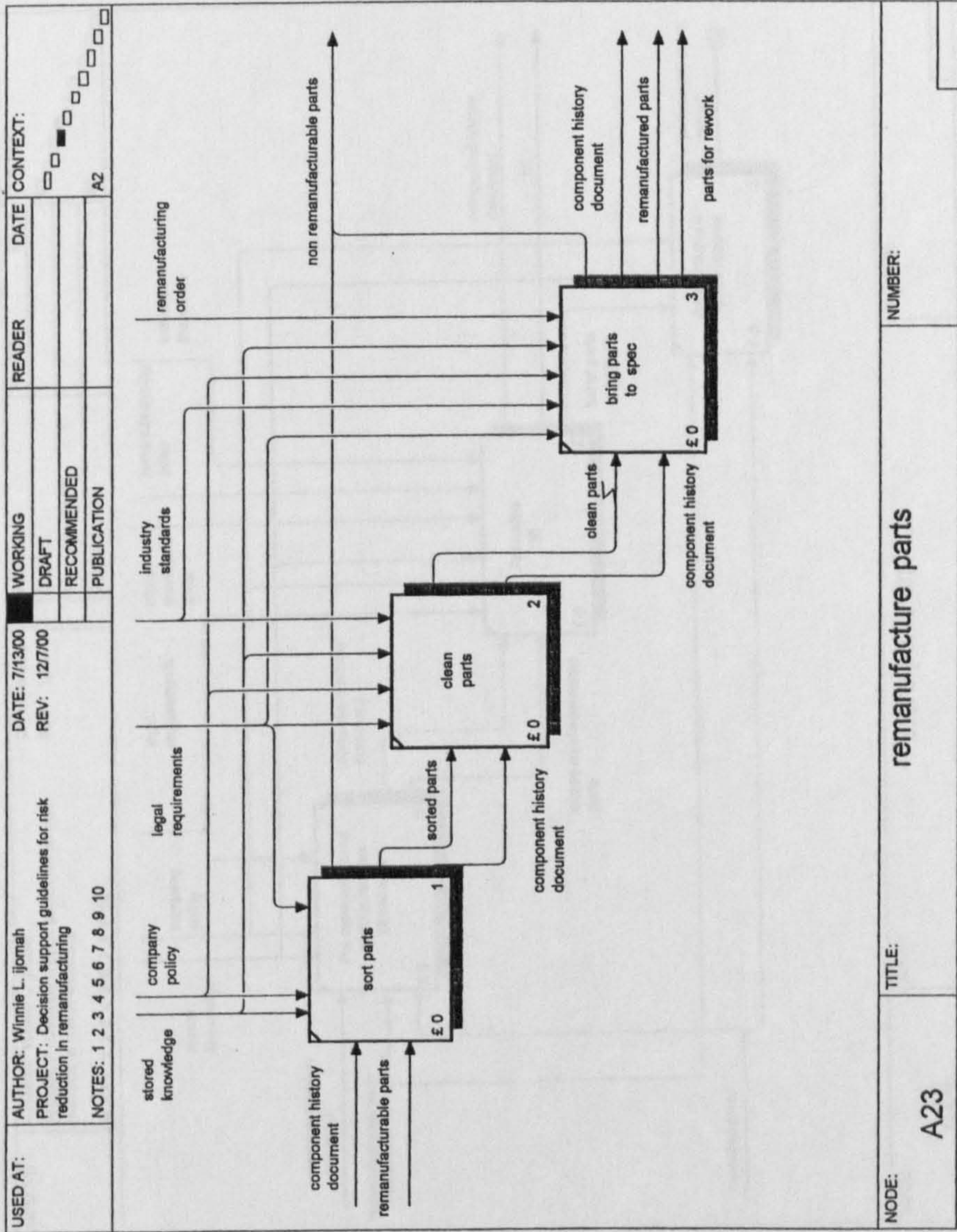

NODE: A23

TITLE: remanufacture parts

NUMBER:

USED AT:	AUTHOR: Winnie L. Ijomah	DATE: 8/4/00	WORKING	READER	DATE	CONTEXT:
	PROJECT: Decision support guidelines for risk reduction in remanufacturing	REV: 12/7/00	DRAFT			<input type="checkbox"/>
	NOTES: 1 2 3 4 5 6 7 8 9 10		RECOMMENDED			<input type="checkbox"/>
			PUBLICATION			<input type="checkbox"/>
						A2

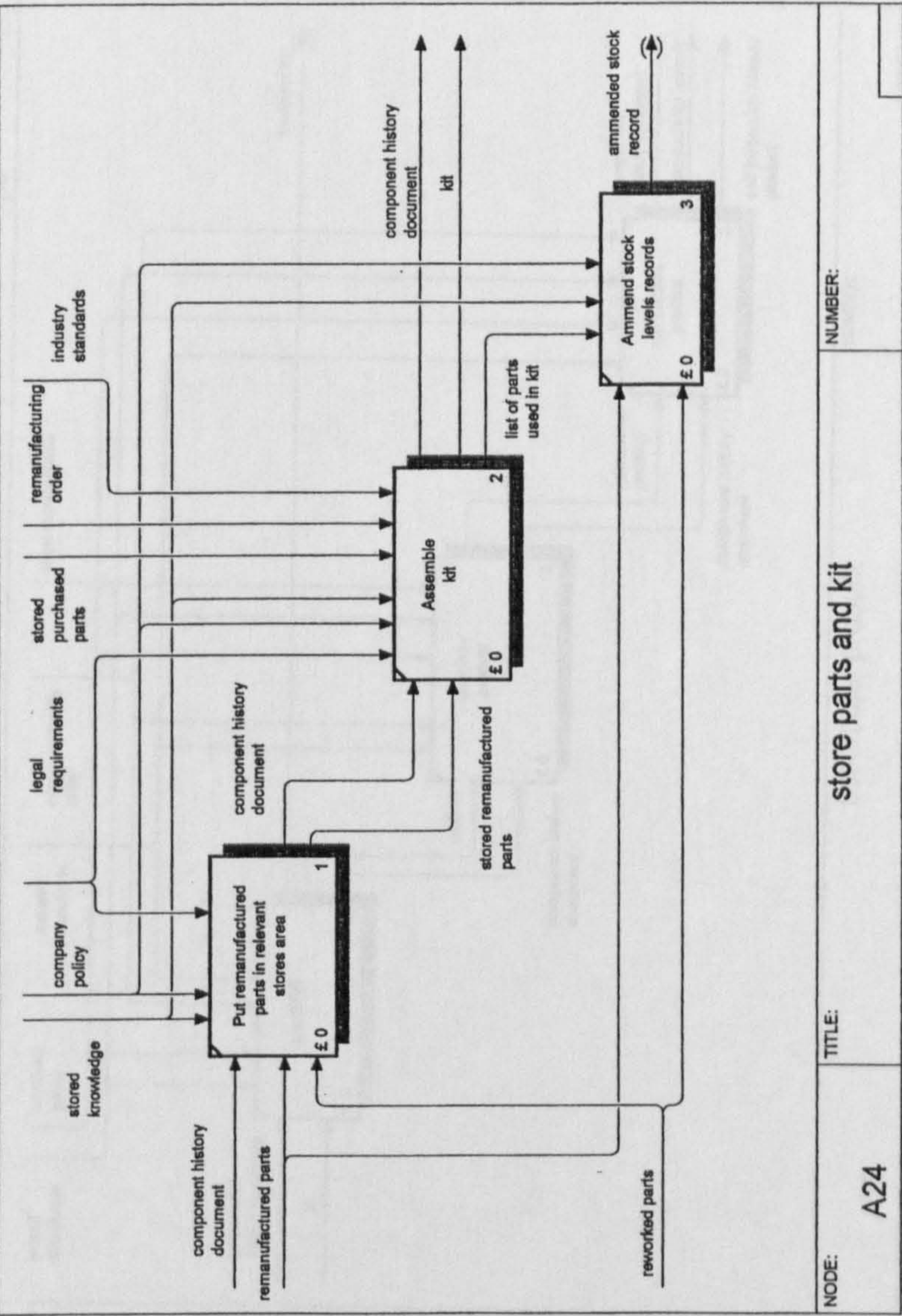

NODE:	TITLE:	NUMBER:
A24	store parts and kit	

USED AT:	AUTHOR: Winnie L. Ijomah	DATE: 7/14/00	WORKING	READER	DATE	CONTEXT:
	PROJECT: Decision support guidelines for risk reduction in remanufacturing	REV: 12/6/00	DRAFT			<input type="checkbox"/> <input type="checkbox"/> <input type="checkbox"/> <input type="checkbox"/> <input type="checkbox"/> <input type="checkbox"/> <input type="checkbox"/> <input type="checkbox"/> <input type="checkbox"/> <input type="checkbox"/>
	NOTES: 1 2 3 4 5 6 7 8 9 10		RECOMMENDED			A2
			PUBLICATION			

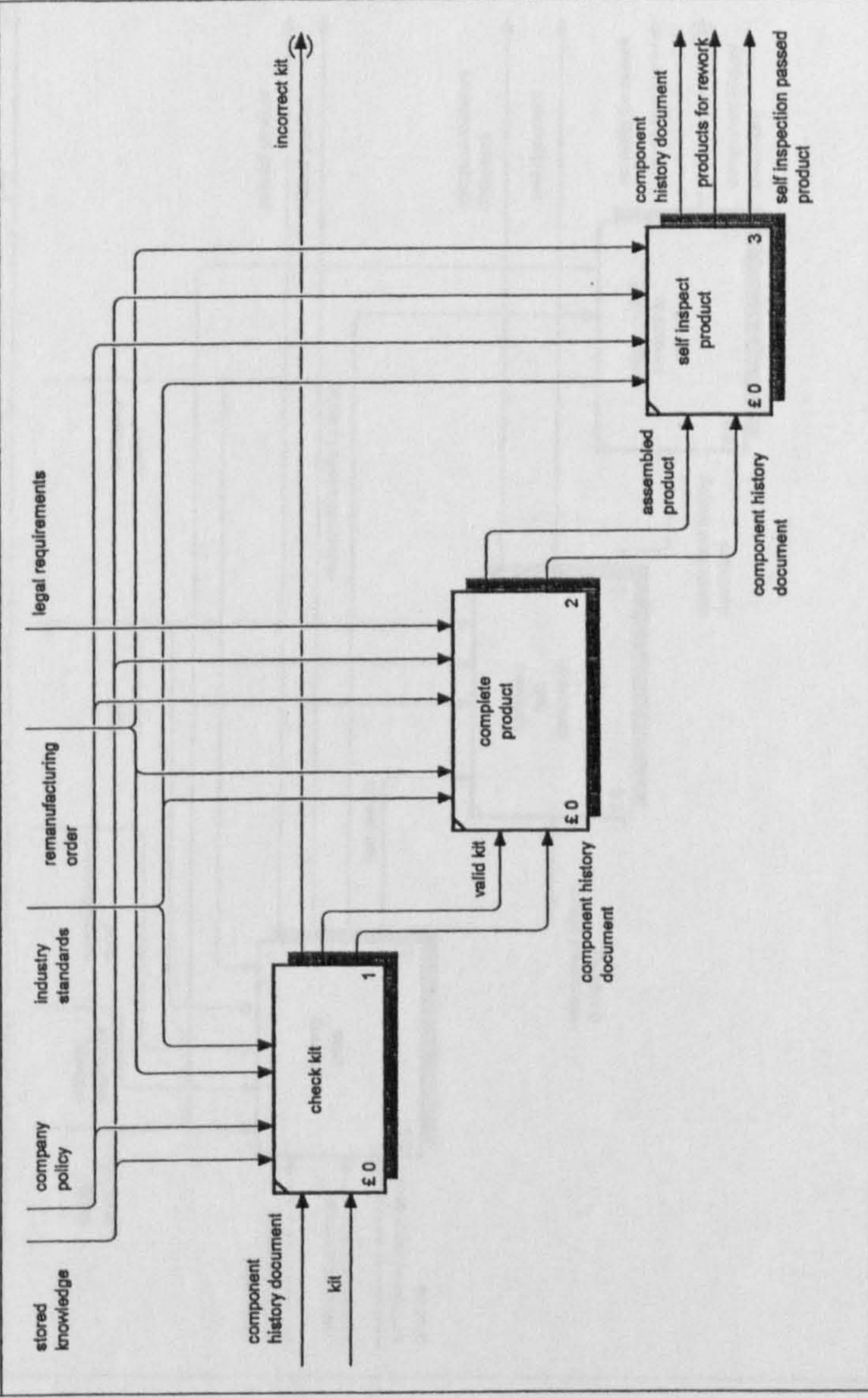

NODE: A25	TITLE: assemble product	NUMBER:
-----------	-------------------------	---------

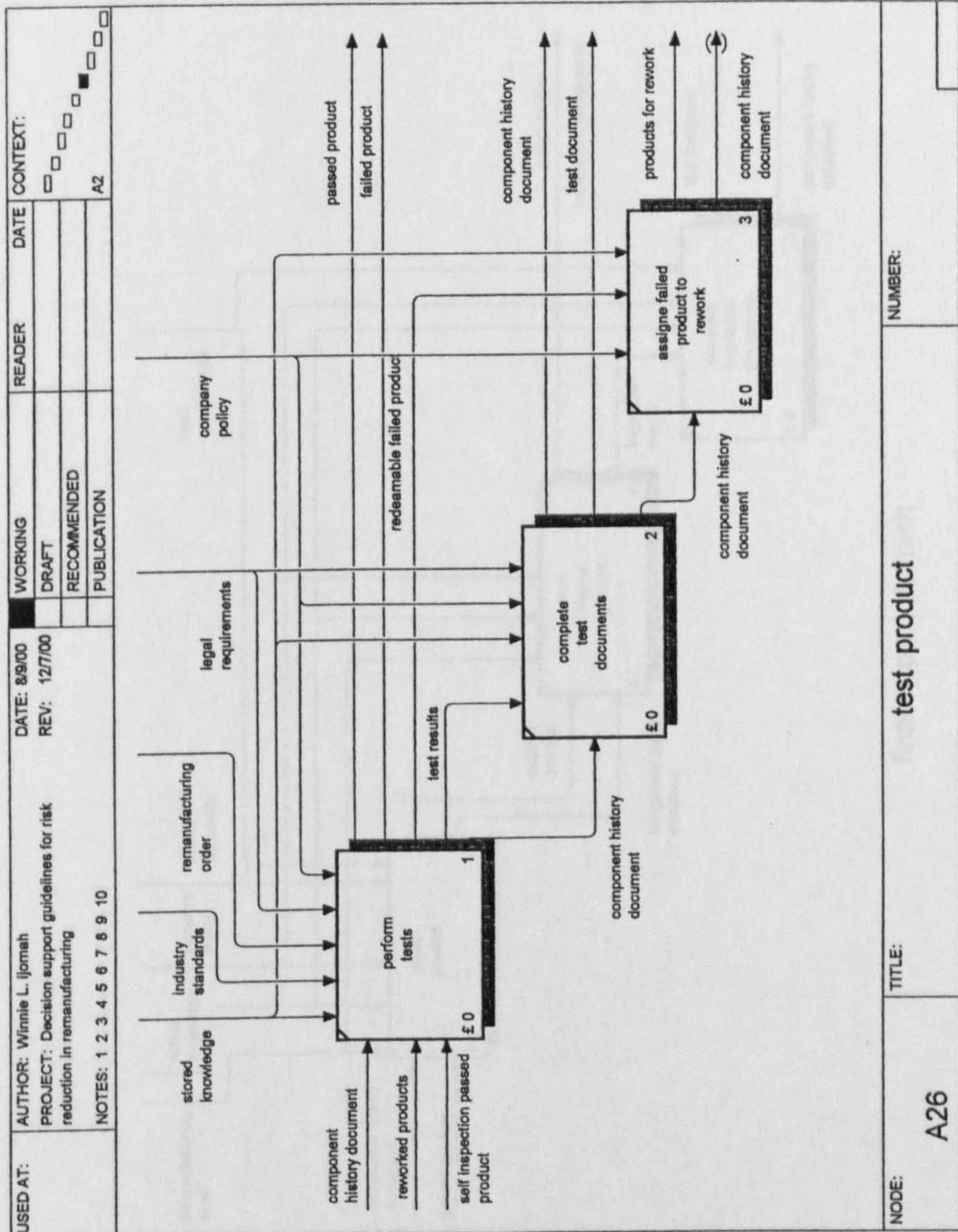

NODE: A26

TITLE: test product

NUMBER:

USED AT:	AUTHOR: Winnie L. Ijomah	DATE: 8/9/00	WORKING	READER	DATE	CONTEXT:									
PROJECT: Decision support guidelines for risk reduction in remanufacturing	REV: 12/8/00		DRAFT			<input type="checkbox"/>	<input type="checkbox"/>	<input type="checkbox"/>	<input type="checkbox"/>	<input type="checkbox"/>	<input type="checkbox"/>	<input type="checkbox"/>	<input type="checkbox"/>	<input type="checkbox"/>	<input type="checkbox"/>
NOTES: 1 2 3 4 5 6 7 8 9 10			RECOMMENDED												
			PUBLICATION			A2									

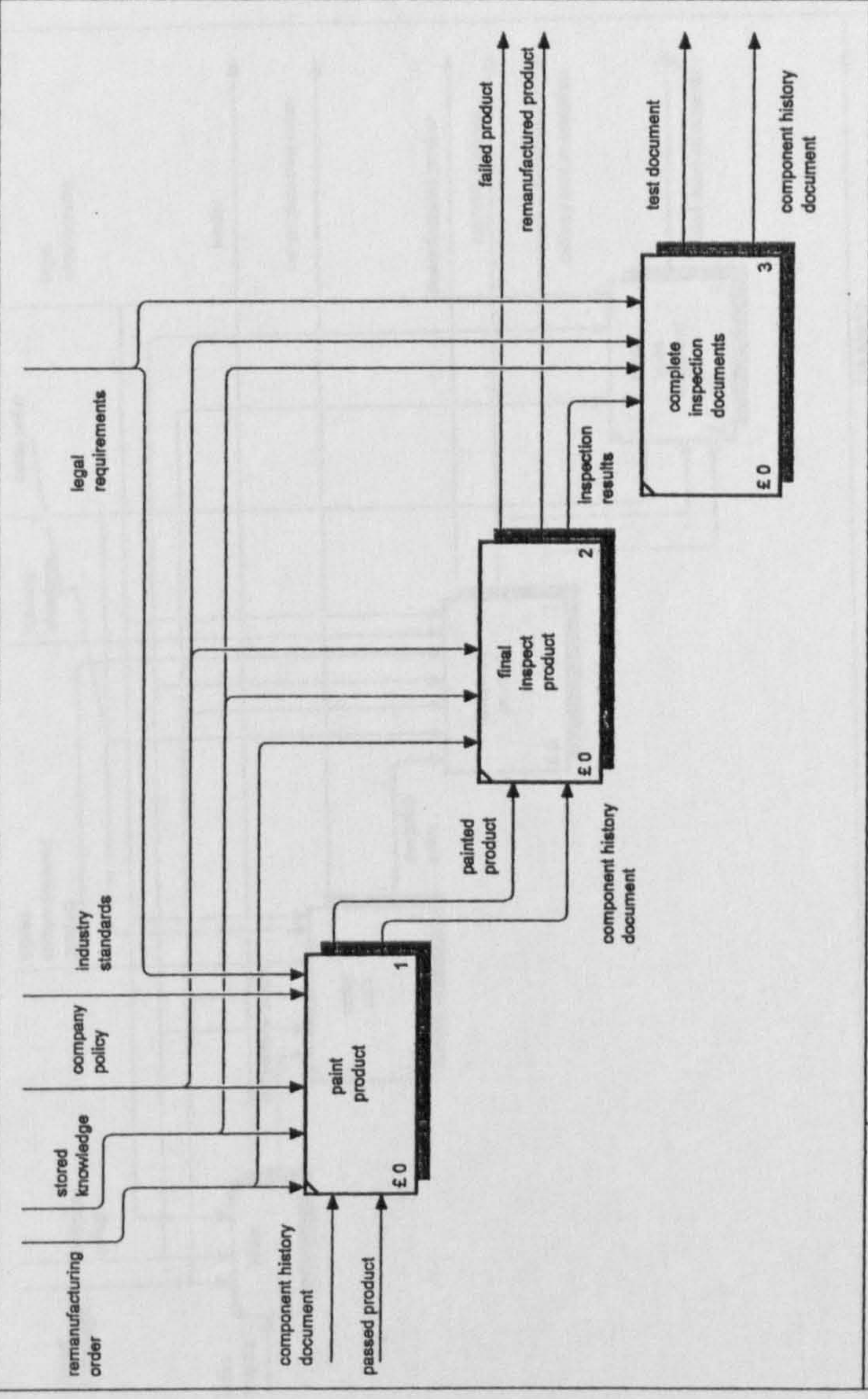

NODE: A27	TITLE: final inspect & finish	NUMBER:
-----------	-------------------------------	---------

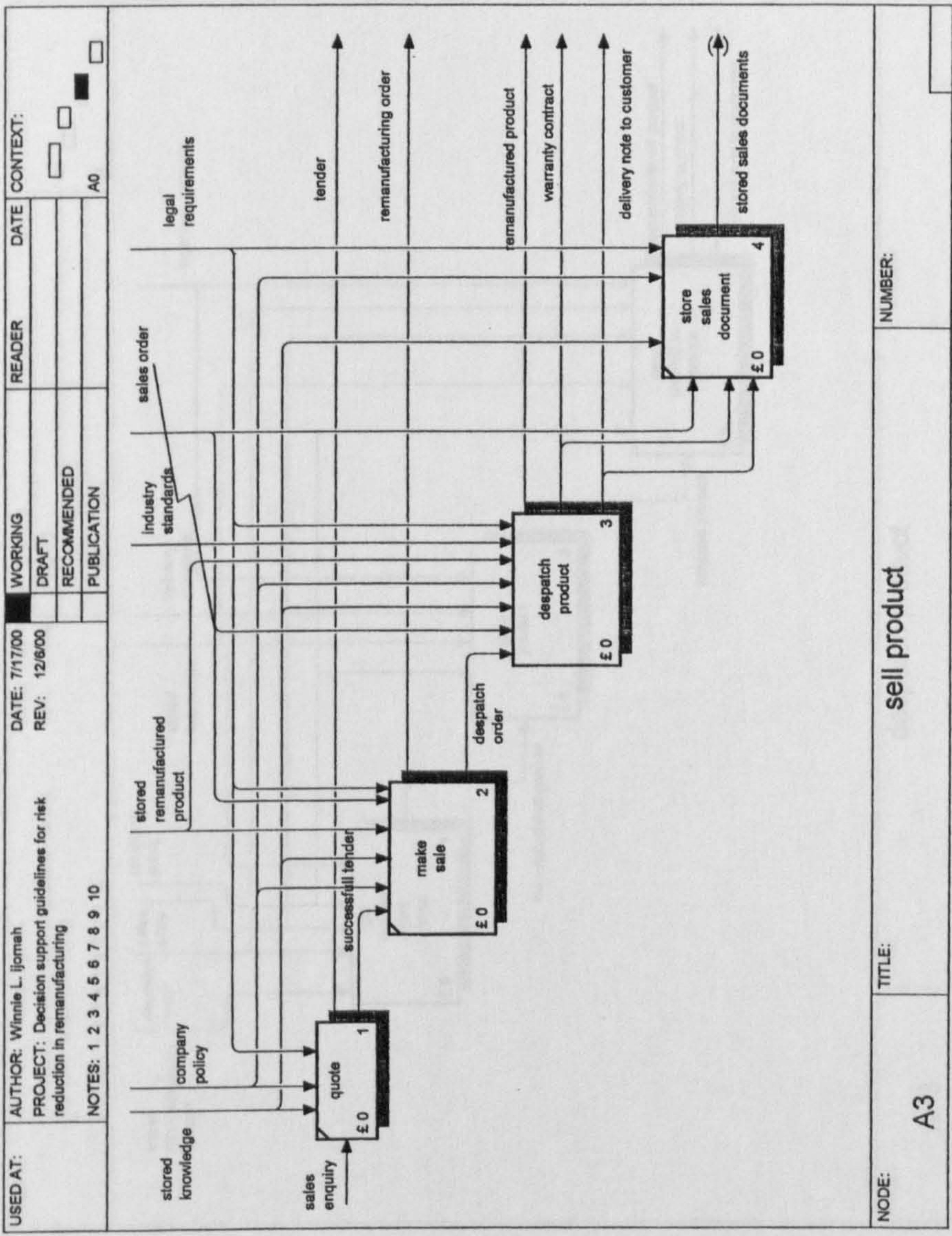

NODE: A3

TITLE: sell product

NUMBER:

USED AT:	AUTHOR: Winnie L. Ijomah	DATE: 7/18/00	WORKING	READER	DATE	CONTEXT:
	PROJECT: Decision support guidelines for risk reduction in remanufacturing	REV: 12/6/00	DRAFT			<input type="checkbox"/>
	NOTES: 1 2 3 4 5 6 7 8 9 10		RECOMMENDED			<input type="checkbox"/>
			PUBLICATION			A3 <input type="checkbox"/>

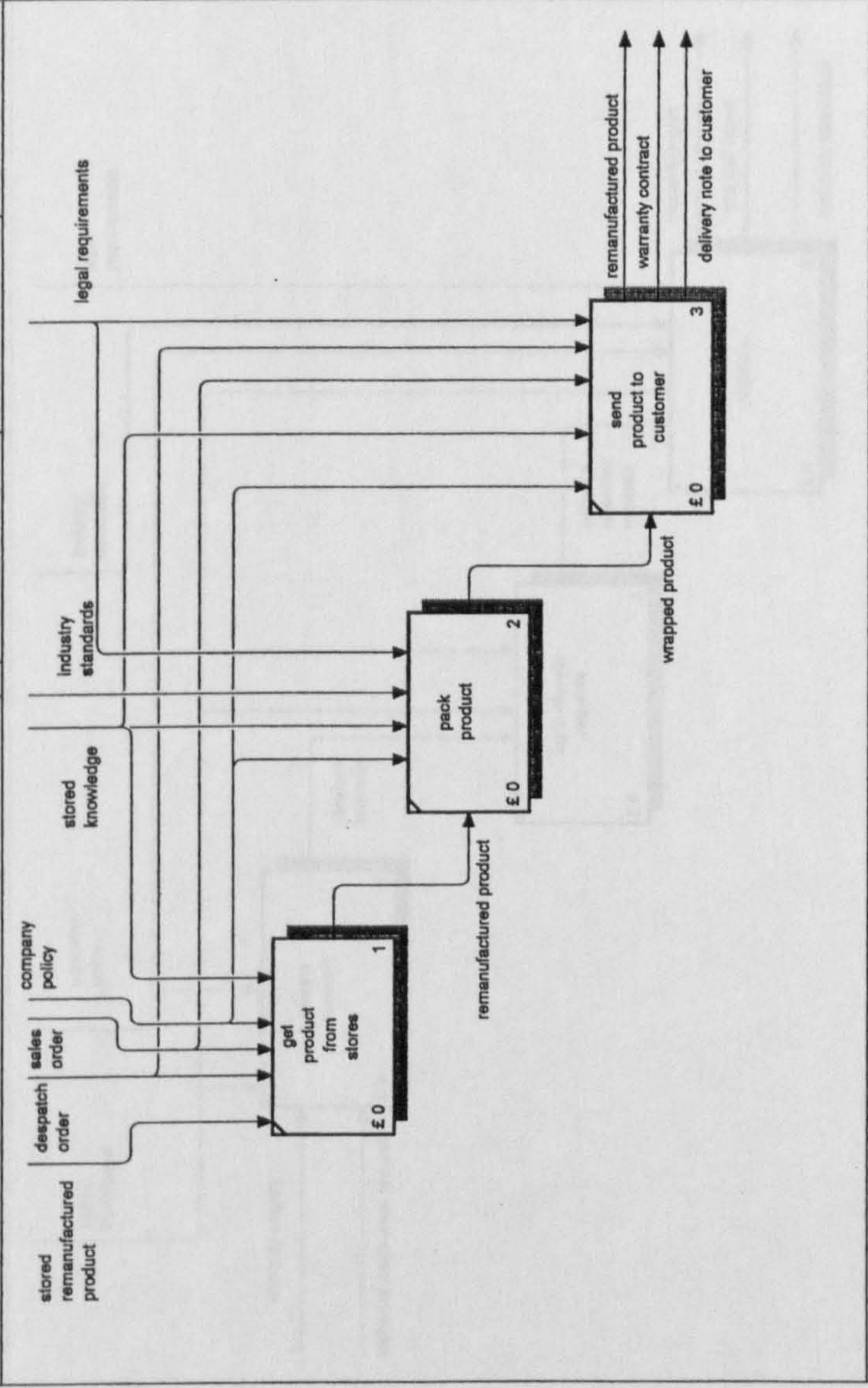

NODE: A33	TITLE: despatch product	NUMBER:
-----------	-------------------------	---------

USED AT:	AUTHOR: Winnie L. Ijomah	DATE: 12/6/00	WORKING	READER	DATE	CONTEXT:
	PROJECT: Decision support guidelines for risk reduction in remanufacturing	REV: 12/6/00	DRAFT			<input type="checkbox"/>
	NOTES: 1 2 3 4 5 6 7 8 9 10		RECOMMENDED			<input type="checkbox"/>
			PUBLICATION			A0 <input checked="" type="checkbox"/>

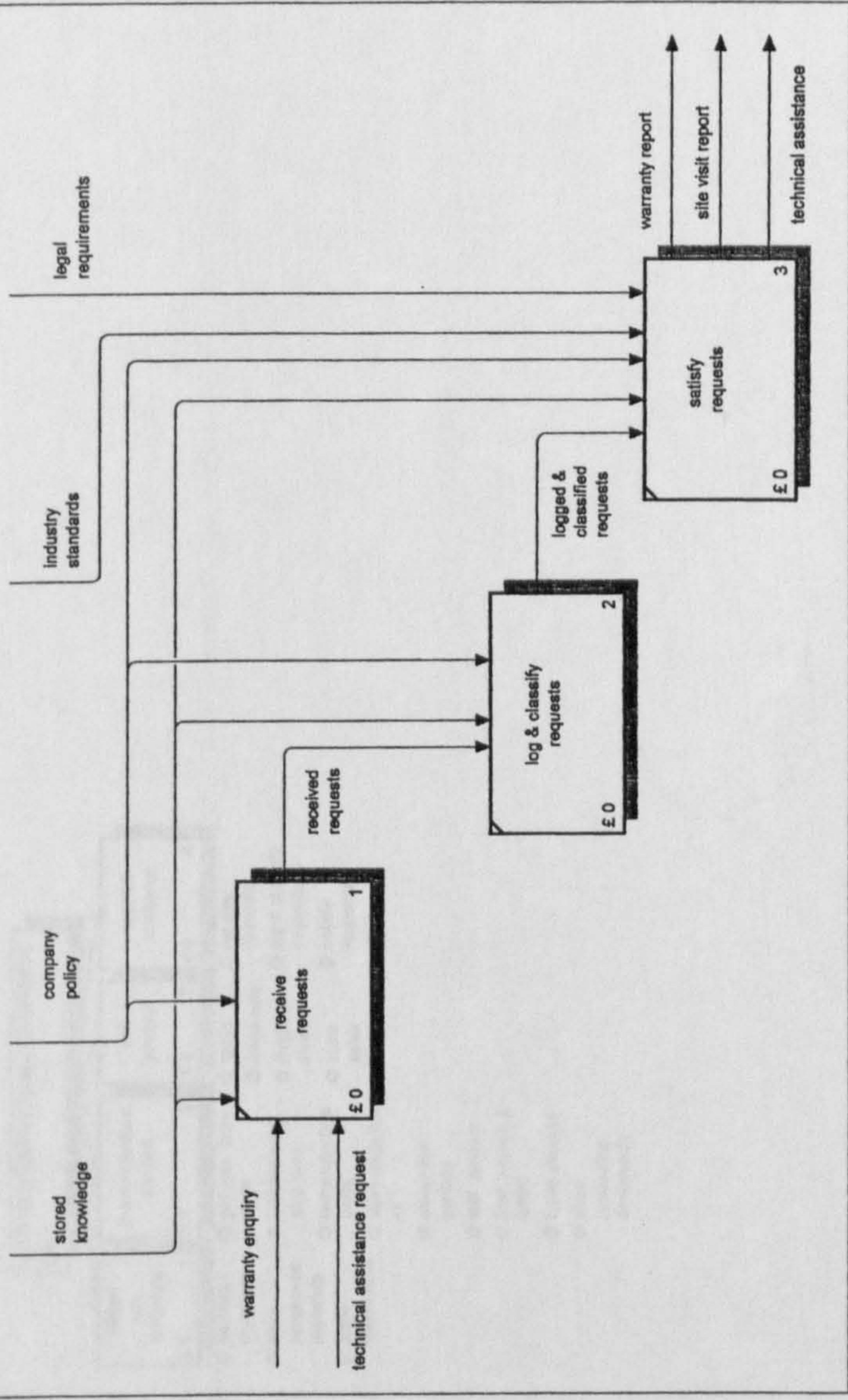

NODE: A4	TITLE: <i>FUNCTION</i> support customer	NUMBER:
----------	---	---------

USED AT:	AUTHOR: Winnie L. Ijomah	DATE: 5/28/02	WORKING	READER	DATE	CONTEXT:
	PROJECT: Decision support guidelines for risk reduction in remanufacturing	REV: 5/28/02	DRAFT			TOP
	NOTES: 1 2 3 4 5 6 7 8 9 10		RECOMMENDED			A-0
			PUBLICATION			

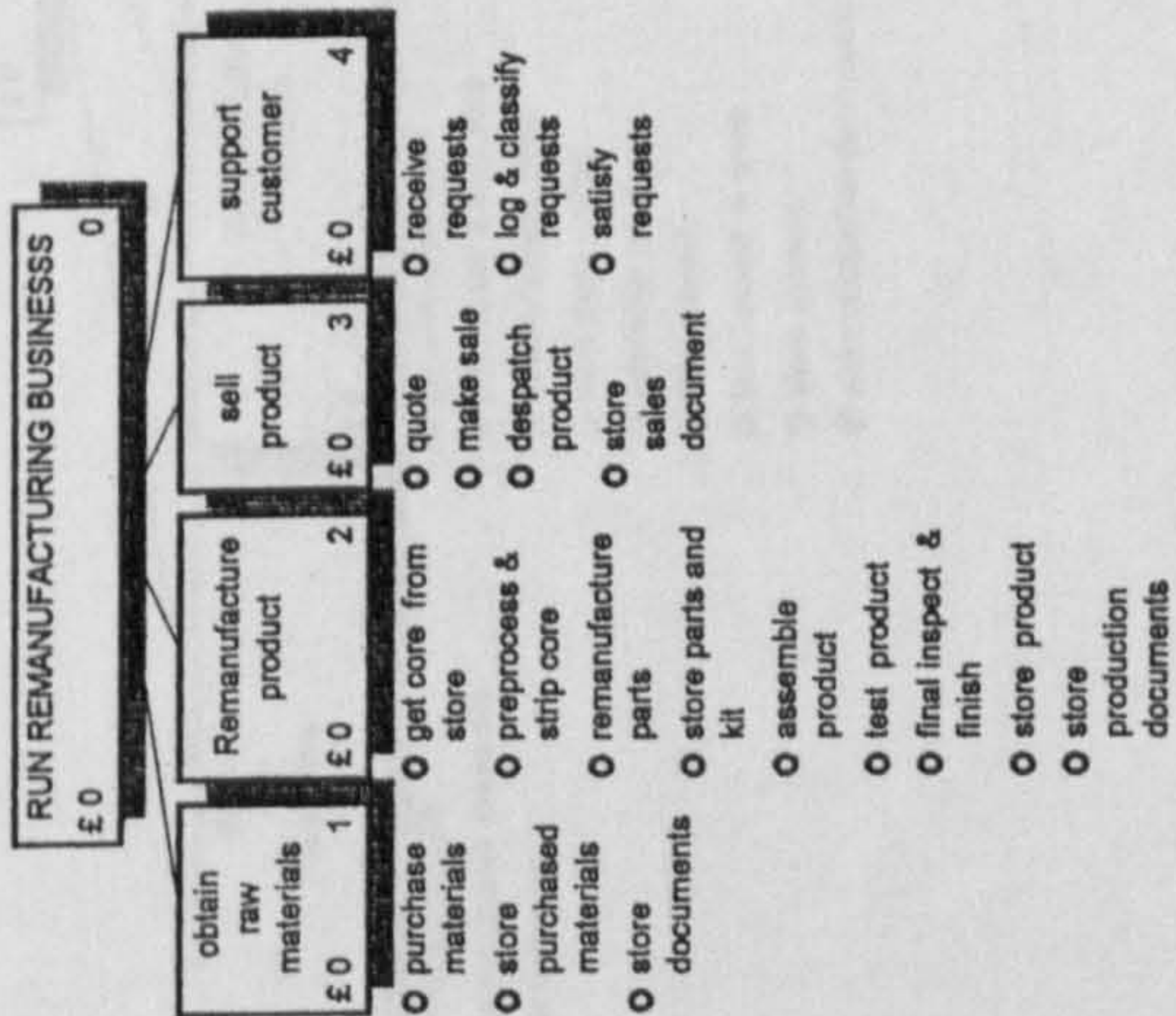

NODE: A0	TITLE: RUN REMANUFACTURING BUSINESSSS	NUMBER:
----------	---------------------------------------	---------

USED AT:	AUTHOR: Winnie L. Ijomah	DATE: 5/28/02	WORKING	READER	DATE	CONTEXT:
	PROJECT: Decision support guidelines for risk reduction in remanufacturing	REV: 5/28/02	DRAFT			TOP
	NOTES: 1 2 3 4 5 6 7 8 9 10		RECOMMENDED			A-0
			PUBLICATION			

RUN REMANUFACTURING BUSINESS
£ 0

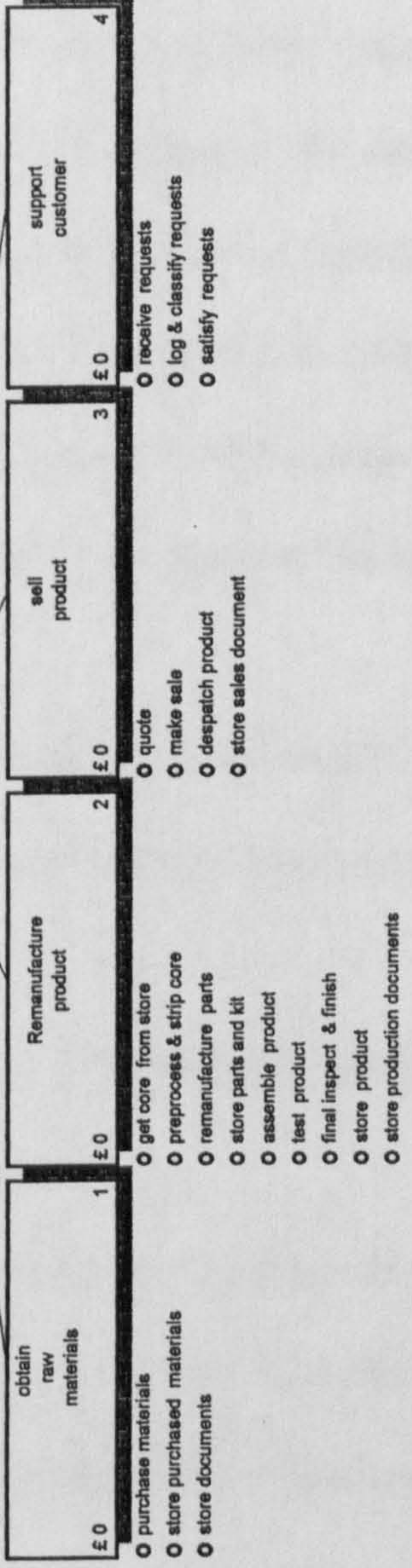

NODE:	TITLE:	NUMBER:
A0	RUN REMANUFACTURING BUSINESS	

USED AT:	AUTHOR: Winnie L. Ijomah	DATE: 7/16/00	WORKING	READER	DATE	CONTEXT:
	PROJECT: Decision support guidelines for risk reduction in remanufacturing	REV: 4/5/02	DRAFT			TOP
	NOTES: 1 2 3 4 5 6 7 8 9 10		RECOMMENDED			
			PUBLICATION			

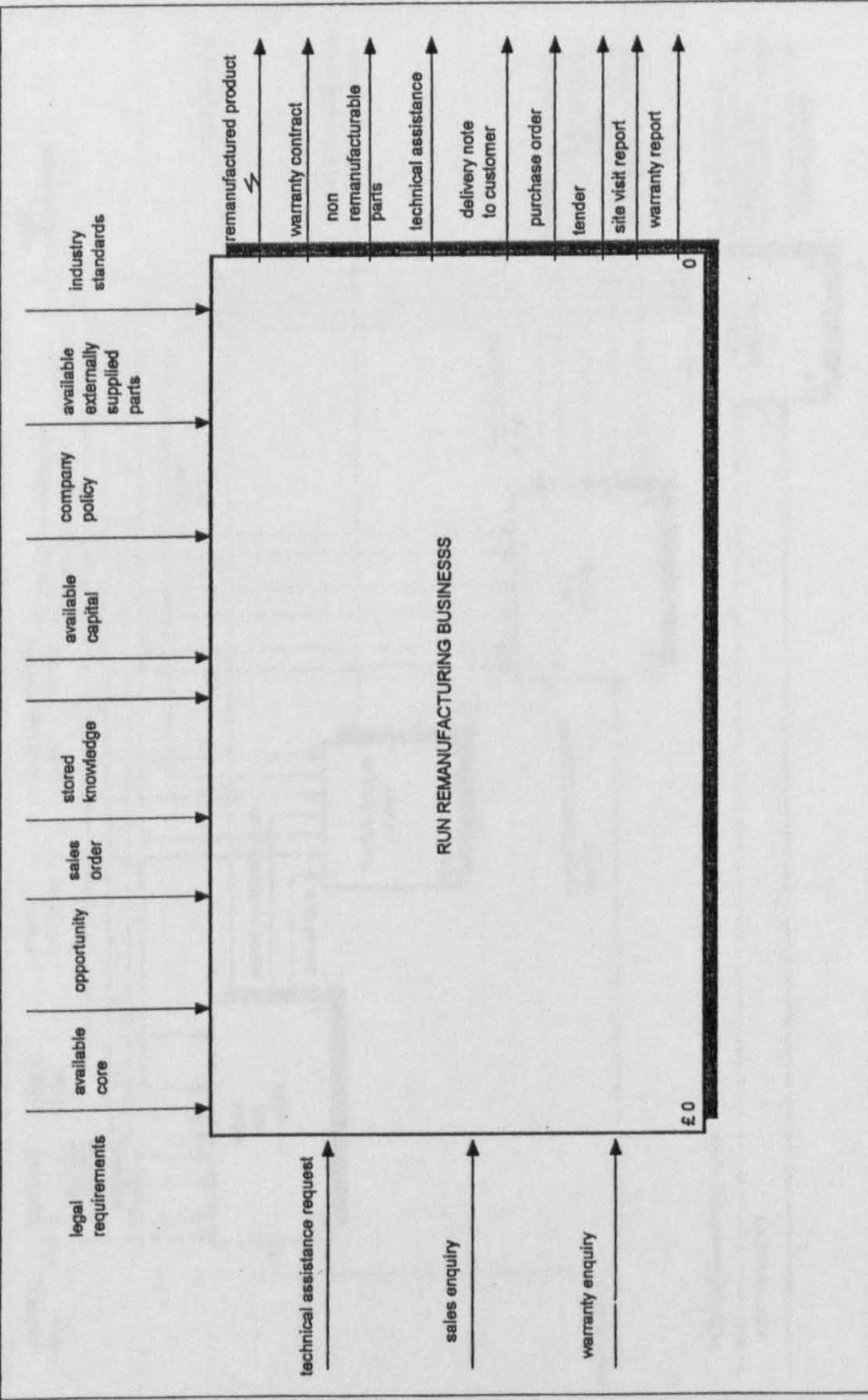

NODE: A-0	TITLE: RUN REMANUFACTURING BUSINESS	NUMBER:
-----------	-------------------------------------	---------

References

A

Aguiar M. W., Weston R. H. and Roberts S. (1993) "Model based approach supporting the life cycle of integrated manufacturing enterprises", Proceedings of the international conference on computer integrated manufacturing, September, Singapore.

Amezquita T., Hammond R., Salazar M. and Bras B. (1996)," Characterizing the remanufacturability of engineering systems", Proceedings of ASME advances in design automation Conference, September 17-20, Boston, Massachusetts, USA, DE-vol.82, pp.271-278.

AMICE ESPRIT, 1989, CIM-OSA Reference Architecture.

Andreu, Jean-Jacques (1995) "The remanufacturing process" Manchester Metropolitan University, UK

Askin R and Standridge C. (1993), "Modeling and analysis of manufacturing systems", New York John Wiley and Sons Inc.

Ayer A (1936) " Language, truth and logic", London Blackwell

Ayres R. Ferrer G. , Van Leynseele T. (1997) " Eco-efficiency, asset recovery and remanufacturing" Centre for the Management of Environmental Resources; INSEAD; Fontainebleau; France.

B

Bendz D. J. (1993) "Green products for green profits" The Spectrum; September, pp. 63-66

Bennett et al (1995) " Different types of manufacturing processes and IDEF0 models describing standard business processes", Working paper WP/Gr/jJ5010-6, EPSRC Grant GR/J 95010, August 1995, Deliverable 3. UK

Berry S. (1996) "Design for recycling" Engineering Designer; IED Year Book, July, pp. 8-14

Bititci U., Bourne M., MacBryde J. (2001) "Performance indicators for sustainable competitive advantage", The international working conference on strategic manufacturing, August, Denmark.

Bopp R. and McDaniel M. (1995) "The gray market trojan horse" IEEE Transactions on Industry Applications, vol.31, No. 3, May/June, pp. 535-541.

Bothe D. R. (1992), "SPC for the remanufacturing industry", APICS REMAN seminar proceedings, September 23-25, pp 101- 106, USA

Boyer J (1992) "Overcoming five conventional wisdom "APICS REMAN Seminar proceedings, September 23-25, pp. 89 –94, USA

Brayman B (1992) "How to implement MRP 11 successfully the second time: getting people involved in a remanufacturing environment" APICS REMAN Seminar proceedings , September 23-25, pp. 82-88, USA

Buffa (1980) "Research in operations management" Journal of Operations Management, Vol. 1 No.1

C

Campbell and Stanley (1965) "Experimental and quasi-experimental designs for research" Rand-McNally. Chicago

Chase R.B. (1980) "A classification and evaluation of the research in operation management" Journal of Operations Management, Vol.7. No.1

Checkland P. B. (1981) "Systems thinking, systems practice , John Wiley and Sons , Chichester.

ChecklandP. B. and Scholes J. (1990) "Soft systems methodology in action", J Wiley and Sons, New York.

Chen M. (1999) "BPR methodologies, methods and tools" Business Process Engineering: Advancing the State of the Art; edited by Elzinga D. J. , Gulledge T. R. and Lee C. Y. Norwell, Massachusetts: Kluwer Academic Publishers. pp. 187-211

Chetty S. (1996) " The case study method for research in small and medium-sized firms " International small business Journal, Vol.15 No. 1 pp.73- 85

Childe S, Smart P, Weaver A (1996), "The use of generic process models for process transformation" The international workshop on modeling techniques for business process re-engineering and benchmarking, pp. 51-62.

Chiodo J (1999) "A feasibility study on active disassembly using smart materials: A comparison with conventional end-of-life strategies" Brunel University, UK.

Chiodo J (1999)"Shape memory alloy actuators for ADSM of consumer electronic products" Brunel University, UK.

Clegg A. and Williams D. "Production planning and control for companies with remanufacturing capability" (1995), Proceedings of the IEEE International symposium on Electronics and the Environment, pp.186 -191

Colquhoun, G. J. Baines R.W. and Crossley R. (1992) "A State of the art review of IDEF0" International Journal of Computer Integrated modelling Vol. 6 No. 4: 252-264

Corke D. (1977), "Production control in engineering", UK, Edward Arnold.

Creswell J W. (1998)"Research design: qualitative and quantitative approaches"; London ,Sage publications

D

Dagger B. (1992), "Greener cars - recycling plastics", Engineering Designer; March, pp. 21-22.

Davenport T.H. and Short J. E. (1990). The new industrial engineering: information Technology and business process redesign. Sloan Management Review; Summer

Denzin N , Lincoln Y (1994) "Introduction: entering the field of qualitative research"

Handbook of qualitative research, pp. 1-17, Thousand Oaks, CA, Sage Publications.

Devore (1992) "Reman, Core, and New-BOM Structuring That Works for You", APICS

1992 Remanufacturing Seminar. , September 23-25, pp.74-77

Dorador J and Young R (2000) " Application of IDEF0, IDEF3 and UML methodologies in

the creation of information models" International Journal of Computer Integrated

Manufacturing , 2000, vol. 13 No. 5, 430-445.

Douglas J. (1976) " Investigative social research" Sage Publications; Beverly Hills

Doumeingts G. and Browne M. D., (1996). "Business modeling in the transformation of a

cost unit into a service unit", International Workshop on Modelling Techniques for Business

Process re-engineering and Benchmarking, Bordeaux, France,. pp. 42-51

Doumeingts G , Chen D, Marcotte F. (1992), "Concepts, models and methods for the

design of production management systems" ATPMS'92, International Seminar on

advanced technologies in production management systems, May 5-8, Beijing Clouded

E

Earl M (1994); " The new and the old of business process redesign" The Journal of

Strategic Information Systems. Vol. 3, No.1, pp5-22.

Easterby-Smith et al (1993), "Management research: an introduction"; London; Sage

Publications

Eden C. (1994), "Cognitive and problem structuring for system dynamics model building",

Systems dynamics Review vol. 10, No.2-3 Summer-Fall.

Eisenhardt k (1998) "Building theory from case study research" Academy of Management

Review Vol. 14, No. 4: 532-550.

F

Ferrer G. (1996) "Market segmentation and product line design in remanufacturing"
INSEAD, Technology Management Area, Blvd. Constance, F-77305 Fontianebleau,
France.

Ferrer G. (1996) "On the economics of remanufacturing a Widget" INSEAD, Technology
Management Area, Blvd. Constance, F-77305 Fontianebleau, France.

FIPS PUBS, 1993, "Integration definition for function modelling (IDEF0)", Federal
information processing standards publication 183, National Institute of standards and
technology, USA.

G

Gager and Schwartz (1994) "Legislation and regulatory challenges and opportunities for
the remanufacturing industry" 1994 APEX remanufacturing Seminar Proceedings. USA, pp.
64-65

Glaser D. J., Strauss A. L. (1967) "The discovery of grounded theory: strategies for
qualitative research" Aldine Publishing; New York.

Goldberg L (1998) "Computers that recycle themselves? maybe in the future, with "shape-
memory" materials" Electronics Design. September 1, pp. 29-31

Gonzalez R., Gala M (1994), "Optimal investment: a dynamic problem" Proceedings of the
Modelling and Simulation ESM '94 Conference, pp. 338-343, Spain.

Gorman G., Hanlon D. And King W. (1997) "Some research perspectives on
entrepreneurship education, enterprise education and education for small business
management: a ten-year literature review", International Small Business Journal, Vol. 15
No. 3, pp. 56-77

Guide and Srivastava (1997a), "Recoverable manufacturing systems: a framework for
analysis", Proceedings of the 1997 Portland International conference on management of

Engineering and Technology (PICMET '97), pp. 675-678.

Guide and Srivastava (1997b) "An evaluation of capacity planning techniques in a remanufacturing environment, International Journal of Production Research. Vol. 35, No. 1, pp. 67-82

Guide (1999) "Remanufacturing production planning and control: U.S industry best practice and research issues", Second International Working Paper on Re-use; Eindhoven, pp. 101-114

Guide and Gupta (1999) "A queuing network model for a remanufacturing environment" Second International Working Paper on Re-use; Eindhoven, pp. 115-128

Guide and Srivastava R. (1999) "Repair or remanufacture: a comparative evaluation", Second International Working Paper on Re-use; Eindhoven, pp. 129-140

Gummesson E. (1993) "Case study research in management: methods for generating qualitative data" Stockholm University, Department of Business administration. Preliminary Script edition 2.

H

Hamblin D., Lettman A. (1995) "A process model for advanced manufacturing technology implementation" Management and New Production Systems, The proceedings of the 2nd International Conference of the European operations management association, University of Twente, Netherlands 28-31, pp. 187-196

Haynsworth H.C. and R.T. Lyons (1987) "Remanufacturing by design, the missing link" Production & Inventory Management; Second Quarter, pp. 24 -28

Hill (1987) "Teaching and research directions in production/operations management" International Journal of Operations and Production Management, Vol.7 No 4.

Hill T (1996), "Manufacturing strategy"; Macmillan Education

Holloway I. (1997) "Basic concepts for qualitative research" Malden, MA, Blackwell Science.

Hormozi A. (1996) "Remanufacturing and its consumer, economic and environmental benefits" APIX Remanufacturing Symposium, May 20-22, USA, pp.5-7.

Hunt V.D (1996) "Process mapping: how to reengineer your business process" New York, John Wiley and Son.

I

Ishii K, Lee B. (1996) "Reverse fishbone diagram: A tool in aid of design for product retirement" ASME Design Technical Conference- Design for manufacturability, September , Irvine, CA

J

Johnson P., Duberley J. , Pendlebury A. J. and Wheeler W. A. (1999) "Negotiating field roles in manufacturing management research", International of Operations and Production Management, Vol. 19, No.12, pp 1234-1253.

Jones E (1999) "The product ideas tree: a tool for mapping creativity in ecodesign" Brunel University; UK.

K

Kim C. (1990) "Issues on manufacturing flexibility" Proceedings of the 5th International conference on Operations Management Association, Manufacturing strategy- theory and practice, Warwick, UK, June 26-27, pp. 293-305.

Kolb D. A. , Rubin I. M. and Mc Intyre et al (1979) "Organisational psychology: an experimental approach" London; Prentice-Hall.

Krupp J A (1992) "Core obsolescence forecasting in remanufacturing" Production and

Inventory Management Journal; Second Quarter, pp. 12-17

Krupp J.A. (1993) "Structuring bills of materials for automotive remanufacture" Production & Inventory Management Journal; Fourth Quarter, pp. 46-51

L

Landry M., Malouin J.L., Oral M. (1983), " Model validation in operations research"; European Journal of Operational Research 14, pp. 207-220

Lang G. and Heis G. (1994) "A Practical guide to research methods" University Press of America, Inc

Layder D. (1993) "New strategies in social research" Cambridge, Polity Press

Le Clair S. R. (1982) "IDEF the method, architecture, the means to improve manufacturing productivity", SME Technical paper MS82-902, Michigan USA.

Lorec W. (1994) "100% salvage" APICES Remanufacturing Seminar Proceedings, USA , pp.53-55

Lund R. (1984) "Remanufacturing" Technology review, Vol. 87, No. 2, pp. 18-23

Lund R.T. (1984) "Remanufacturing: The experience of the U.S.A. and implications for the Developing Countries" World Bank Technical Paper No. 3.

Lund R.T. (1996) " The remanufacturing industry: hidden giant" Boston University; USA

M

Marchall C. and Rossman G. (1989) "Designing qualitative research" Newbury ParK , CA, Sage Publications

Maul R., Weaver A, Childe S., Smart A, Bennett J (1995) "The application of BPR to SMEs" Management and new production systems. The proceedings of the 2nd International Conference of the European operations management association, University of Twente, Netherlands 28-31, pp. 305-313

Mayer R. J.(1992), “ Information integration for concurrent engineering (IICE) IDEF4 object-oriented design method report”, Knowledge based systems Inc., Texas, USA.

McCaskey D. (1994) “Anatomy of adaptable manufacturing in the remanufacturing environment” APICS Remanufacturing Seminar Proceedings, USA, pp. 42-45.

McMaster P.(1989) “Renaissance in remanufacturing” Manufacturing Engineer, October, pp. 23-24

Meredith J. R. (1993). “Theory building through conceptual methods”, International journal of operations and production management, Vol. 13, No. 5; 3 -11.

Meredith J. R. (1998) “Building operations management theory through case and field research” Journal of Operations Management vol. 16: 441-454

Meredith J.A., Raturi A., Amoako-Gyampah K. and Kaplan B. (1989), Alternative research paradigms in operations, Journal of Operations Management, Vol. 8, No. 4: 297-326

Mertins K, Jochem R., Jakel F. (1996) “Integrated business process modeling, analysis and supporting tools” The international workshop on modeling techniques for business process re-engineering and benchmarking, pp.61-70. .

Mingers J. (1992), “ Recent developments in critical management science”, Journal of Operations Research Society, Vol. 43, No. 1, pp 1-10

Morgan G. and Smircich L. (1980) “The case for qualitative research”, Academy of Management Review; Vol. 5, pp. 491-500

N

Nasr and Varel (1996) “Lifecycle analysis and costing in an environmentally conscious manufacturing environment, APICS Remanufacturing Symposium Proceedings, USA, pp.44-47.

O

O'Brien J, Childe S., Maull R. (1994) "Information technology for business process re-engineering in the service sector" Operations strategy and performance, papers from the first international conference of the European operations management association, June 27-29, University of Cambridge, UK pp. 49-54.

Oliver N., Wilkinson B. (1992) "The Japanisation of British industry" Oxford, Blackwell

O'Sullivan D. (1994) "Manufacturing systems redesign: creating the integrated manufacturing environment" NJ, Prentice Hall.

Ould M. A. (1995) "Business processes: modeling and analysis for re-engineering and improvement" London; John Wiley and Sons

P

Petrakis (1993) "recycling technologies and market opportunities" Conference proceedings at Brookhaven National Laboratories, USA

Pettigrew A. and Whip R. (1991) "Managing change for competitive success", Oxford, Blackhill Publishers

Platts K. W. (1993) "A process approach to researching manufacturing strategy" International Journal of Production Research, Vol. 13 No 8.

Poole and Simon (1997) "Technological trends, product design and the environment", Design Studies Vol. 18, No.3, pp. 237-248

Porters M.E. (1985) Competitive advantage: creating and sustaining superior performance, The Free Press, New York

R

Reisman A. (1988) "On alternative strategies for doing research in the management and social sciences", IEEE transactions of engineering management, December, Vol. 35, No. 4, pp.215-220

Romano C. A. (1989) "Research strategies for small businesses: a case study approach"
International Small business Journal, Vol. 7, No.4, pp.35-43.

S

Simon et al (1998) "Ecodesign navigator: a key resource in the drive towards environmentally efficient product design" Manchester Metropolitan university- Cranfield University (EPSRC), UK.

Slack N. (1988) "Manufacturing systems flexibility- an assessment procedure" Computer Integrated manufacturing systems. Vol 1, No. 1, pp. 25-31

Smart et al (Nov. 1995) "Guidelines for linking activity and information models of business processes", EPSRC Grant GR/j95010; Working paper WP/GR/j95010-7.

Smart et al (1995) "Guidelines for linking activity and information models of business processes-IDEF0 to IDEF1x" EPSRC Grant GR/J95010, working paper WP/GR/J95010-7.

Strauss A. and Corbin J. (1990) "Basics of qualitative research: grounded theory procedures and techniques. Newbury Park, CA, Sage publications.

Susman G. I. and Evered R. D. (1978) "An assessment of the scientific merits of action research" Administrative Science Quarterly, Vol. 23; pp.582-602.

T

Thierry et al (1995), "Strategic issues in product recovery management", California management Review. Vol.37, pp.114-135.

Thomas K. W. and Tymon W. G. (1982) "Necessary properties of relevant research: Lessons from recent criticism of organisational science" Academy of Management Review, Vol. 7 No3. 345-352

Tulip S. (1997) "Second-hand material" Manufacturing Engineer , April, pp. 76-79

V

Vandermerwe S. and Oliff M. (1991), "Corporate challenge for an age of reconsumption",
The Columbia Journal of World Business, vol.27, No.3, pp 7-25.

Von Bertalanffy L. (1968) "General systems theory" Braziller, New York.

Vos B., Akkermans H. (1995) "Capturing the dynamics of (re)allocation, participative
business modeling of strategic allocation issues" Management and Production Systems, The
proceedings of the 2nd International Conference of the European operations management
association, University of Twente, Netherlands 28-31, pp..508-517

Voss (1984) "Production/operational management: a key discipline and area for research"
Omega International Journal of Management Science, Vol. 12 No3.

W

Wang W., Popplewell K. And Bell R. (1993), "An integrated multi-view system description
approach to approximate factory modeling" International Journal of Computer Integrated
Manufacturing, Vol. 6, No.3. pp. 165-174

Weaver A. M. (1995), "A model based approach to the design and implementation of
computer aided production management systems" PhD Thesis: The University of Plymouth,
UK 1995.

Whybark D. C. and Ferrer G.(2000) "Building remanufacturing competence: practical needs
and research issues" , Selected papers from the First world conference on production and
operations management, POM Facing the new millenium, Sevilla, DEFDO

Y

Yamamoto R. (1999) " Manifesto on Ecodesign", Ecodesign'99: The first international
symposium on environmentally conscience design and inverse manufacturing, Tokyo.

Yin R (1981) "Case study research: design and Methods"; London; Sage Publications.

Yin R (1989) "Case study research: design and Methods"; London; Sage Publications.

Yin R (1994) "Case study research: design and Methods"; London; Ed 2 Sage Publications.

Z

Zgorzelski and Zeno (1996) "Flowcharts, Data flows, SDT, IDEF and NIAM for enterprise engineering" The international workshop on modeling techniques for business process re-engineering and benchmarking, 18-19 April 1996, Bordeaux, France., edited by Doumeingts

G and Brown J. London: Chapman & Hall pp.71-81

PAGE/PAGES
EXCLUDED
UNDER
INSTRUCTION
FROM
UNIVERSITY