

2024

Transmission+Interference: A New Materialist and Machine-Oriented Approach to Collectively Make-With Noise

Strang, David

<https://pearl.plymouth.ac.uk/handle/10026.1/22212>

<http://dx.doi.org/10.24382/5163>

University of Plymouth

All content in PEARL is protected by copyright law. Author manuscripts are made available in accordance with publisher policies. Please cite only the published version using the details provided on the item record or document. In the absence of an open licence (e.g. Creative Commons), permissions for further reuse of content should be sought from the publisher or author.

This copy of the thesis has been supplied on condition that anyone who consults it is understood to recognise that its copyright rests with its author and that no quotation from the thesis and no information derived from it may be published without the author's prior consent.



**UNIVERSITY OF
PLYMOUTH**

**Transmission+Interference: A New Materialist and
Machine-Oriented Approach to Collectively Make-
With Noise**

by

David Strang

A thesis submitted to the University of Plymouth
in partial fulfilment for the degree of

DOCTOR OF PHILOSOPHY

School of Art, Design, and Architecture

February 2023

Acknowledgements

Thank you to the team who have supported me throughout the development of this research. Special thanks to Dr. Jane Grant for her feedback, suggestions, lively discussion, and continued support as my Director of Studies and to Professor Mike Phillips for his valuable guidance and support. To all the collaborators throughout the practice including members of RADIX (Dr Deborah Robinson and Dr Simon Rundle), Dr. Rocio von Jungenfeld, and Vincent van Uffelen. The long term collaboration between Vincent and myself in all transmission+interference projects has been a wonderful experience of lively, noisy making and performing together that has been invaluable. I would also like to thank Dr Andrew Prior for many useful discussions and encouragement. Finally, I'd like to thank my family and especially my wife, Şengül, for her support throughout the long journey to complete this research.

Author's Declaration

At no time during the registration for the degree of Doctor of Philosophy has the author been registered for any other University award without prior agreement of the Doctoral College Quality Sub-Committee.

Work submitted for this research degree at the University of Plymouth has not formed part of any other degree either at the University of Plymouth or at another establishment.

Publications (or public presentation of creative research outputs):

Strang, D. And Van Uffelen, V. (2016). *transmission+interference: digital synesthesia*. Digital Synesthesia Exhibition, Vienna. 2016.

Strang, D. And Van Uffelen, V. (2016). *transmission+interference: digital synesthesia*. ISEA 2016, Hong Kong. 2016.

Presentations at conferences:

Strang, D. and Van Uffelen, V. (2015). *transmission+interference: noise, resonance, and territory*. In *Proc. ISEA 2015*, Vancouver. 2015.

Word count of main body of thesis: 52,822

Signed: *D. Strang*

Date: 18.02.2023

Abstract

Title: Transmission+Interference: A New Materialist and Machine-Oriented Approach to Collectively Make-With Noise

David Strang

This thesis explores the materiality at play within installation and performance artworks from across the interdisciplinary fields of media arts, digital arts and contemporary technological arts and is positioned at the noisier end of the artistic spectrum of these disciplines. The practice-led research presented here deals with the shift away from clean digital media environments of production in order to embrace a more material focused approach that has emerged within recent years (see the emergence of physical computing and electronics practices), especially across sonic arts practices (see also the re-emergence of modular synthesis).

The aim is to unfold an understanding of the creative potential within the movement and flow of noise in machines or systems utilising light and sound. Central to this aim is the discussion around the physical objects at play within tools / devices / technological machines in order to realise the power in the non-human object and its extended interactions. This is not meant in order to ignore the human but rather as a case to present a more entangled discourse of human, object and machine where the influence of minuscule particles over actions and activities of a machine are viewed as equally important as the hand, flesh and brain that engages with them for creative, artistic purposes. This approach engages with fields of theoretical discourse emerging from post-humanism, in particular Object-Oriented Ontology

(OOO) and New Materialism. This theoretical discourse offers the platform for dealing with the fields of assemblages, territories, resonance, noise, in-between, interference, interaction, and agency through the writings of, among others, Deleuze and Guattari, Ian Bogost, Levi Bryant, Jane Bennett, Elisabeth Grosz, and Michel Serres.

In order to deal with the creative complexity in the topic and to aid the contextualisation of the discourse a variety of practical projects are introduced throughout as examples of and influences upon this practice-led research. These works range from historically influential media and sonic artists such as Nam June Paik and John Cage through to contemporary media and sonic artists and makers such as Martin Howse and John Richards. Entangled throughout this discourse the author presents the collaborative practical research project by David Strang and Vincent Van Uffelen: *transmission+interference*. This practice develops noise devices through open, collaborative workshops exploring the creative potential of noise in light and sound. As many of these devices are constructed for sonic output they suggest the term 'instrument' but that seems to carry too much of a classical connotation of standard musical practice or too scientific - for the purposes of this thesis, the discourse, following Levi Bryant (2014), engages with the term of the 'machine'. The term 'machine' does not ignore the technical objects entangled together and suggests a physicality in support of the materiality of the objects. It also encourages thought around the imperfections of machines (they are not scientific) and suggests that they are, in someway, following from Deleuze and Guattari and Manuel Delanda's discourse of assemblages, appropriated to arrive at

the form they take. The creative art practices that are discussed each offer a unique discourse within the themes of the thesis.

The practice of *transmission+interference* is introduced at the start of this thesis in order to contextualise later discussions around the project. It is here where we first encounter the combinations of objects, things, materials, noise and workshop practices at a surface level before dealing with the complexities of that matter in later sections. This section acts to frame the thesis and subsequent discourse by mapping out the territories of the practice-led research in order to understand what is being made (what objects, things, materials are involved), how it is being made (what forms of collaboration are involved) and what the overall outcomes from the practice are (performances or installations).

The thesis then shifts to deal with the physical matter of things, objects and materials at play within the practice of *transmission+interference* to focus on what Jane Bennett calls ‘the power of things’ (2010) in order to examine the influence and impact of objects across creative workshops and begin to flatten the ontology between the human and non-human components interacting within. The fields of OOO and New Materialism are introduced here as the core theoretical grounding for the thesis as the discourse navigates from objects and things and vibrant units (Bogost) to more complex assemblages (Deleuze and Guattari, DeLanda) and structurally open machines (Bryant).

Following on from this materials focused discourse the thesis then presents the largest object at play within the practice: noise. This section explores the capacities of and for noise from within the fields of sonic arts, avant-garde music, and information theory to present the creative potential of noise within the making process. Presented here is a noisy vitalism (a form of resonance) drawn from the objects and things of the previous section that is now acting within systems to form new emergent machines.

Finally, the thesis discusses the making process itself - the creative workshop, where the physical materials of chapter one and the noise of chapter two are entangled in an assemblage of interactive and intra-active (Barad, 2007) making. This section engages in discourse that has recently moved away from the limiting field of D.I.Y (Do It Yourself) practices to the more openly collaborative D.I.W.O (Doing It With Others). It is here where the entanglement of human and non-human is most richly experienced as the 'Others' is ontologically flattened to include all objects, things, materials, and humans.

What is presented here in this practice-led research is anew methodology embracing in the noisy entanglements of human and non-human materiality that is influenced by sonic arts practices. Through OOO and New Materialism humans are opened up to the inner powers and intra-actions of objects and materials through chance wanderings to reveal new creative potential for sonic arts performances and interactive installations.

Contents

Copyright Statement	1
Title Page	2
Acknowledgements	3
Author's Declaration	4
Abstract	5
Contents	10
List of Figures	12
Collaborations	19
Chapter 1: Introduction: Methodology and Practice	21
1.1 Methodology	22
1.2 Practice: Workshops, Exhibitions, Performances	26
1.3 Practice: Transmitting, Receiving, and Interfering	77
Chapter 2: Objects	93
2.1 Introduction	94
2.2 Objects & Machines	97
2.3 Vital Materials	109
2.4 Vital Assemblages	121
2.5 Conclusion	144
Chapter 3: Noise	146
3.1 Introduction	147
3.2 Sonic Noise	149
3.3 Information Noise	165
3.4 Territories	175
3.5 Dust	190
3.6 Conclusion	201
Chapter 4: Workshops	204
4.1 Introduction	205
4.2 The Workshop	207
4.3 Fields, Worlds, and Territories	223
4.4 DIY / DIWO	244
4.5 Conclusion	258
Transmission+Interference: A Synthesis of Objects, Noise, and Workshops	263
References	270
Bibliography	278
Appendix	282

DavidStrang_Ethics Information.....	283
Participant Information Sheet.....	286

List of Figures

Figure 1. LED Transmitter on perforation board, 03.2013: Detail. Image by David Strang.

Figure 2. LED Transmitter, 07.2014: Detail. Image by David Strang.

Figure 3. LED Transmitter and Receiver, 07.2014: Detail. Image by David Strang.

Figure 4. Speaker Hacking and Victorian Synthesiser, 10.2014: Detail. Image by David Strang.

Figure 5. Hotwire~ workshop, 10.2014: Detail. Image by David Strang.

Figure 6. Performance setup view from David Strang's side of table, Hotwire~. 02.2015: Detail. Image by David Strang.

Figure 7. Performance setup view from Mike Blow's side of table, Hotwire~. 02.2015: Detail. Image by David Strang.

Figure 8. Close up of Elastic Band Drone Machine, 04.2015: Detail. Image by David Strang.

Figure 9. Hotwire~ workshop, 04.2015: Detail. Image by David Strang.

Figure 10. Hotwire~ workshop, 04.2015: Detail. Image by David Strang.

Figure 11. Table view of Hotwire~ workshop, 04.2015: Detail. Image by David Strang.

Figure 12. Preparing materials in workshop, 05.2015: Detail. Image by David Strang.

Figure 13. Intervention in evening section of workshop, installing materials to play with light in the city on hand rails, 05.2015: Detail. Image by David Strang.

Figure 14. Intervention in evening - installing objects to play with light in the city on floor lighting fixtures, 05.2015: Detail. Image by David Strang.

Figure 15. Intervention in evening - marking out shadow lines with chalk, 05.2015: Detail. Image by David Strang.

Figure 16. Workshop group - Transmission+Interference workshop @ ISEA 2015, Vancouver, 08.2015: Detail. Image by ISEA.

Figure 17. Disc Spinner - Transmission+Interference workshop @ ISEA 2015, Vancouver, 08.2015: Detail. Image by David Strang.

Figure 18. Workshop group - Transmission+Interference workshop @ ISEA 2015, Vancouver, 08.2015: Detail. Image by ISEA.

Figure 19. Transmission+Interference: Digital Synesthesia installation @ ISEA 2016, Hong Kong, 05.2016: Detail. Image by David Strang.

Figure 20. Transmission+Interference: Digital Synesthesia installation @ Digital Synesthesia exhibition, Vienna. 03.2016: Detail. Image by David Strang.

Figure 21. Transmission+Interference: Digital Synesthesia receiver module @ Digital Synesthesia exhibition, Vienna. 03.2016: Detail. Image by David Strang.

Figure 22. Stick Chart workshop - electrical signal mapping @ Flowing with the City workshop, Edinburgh. 06.2016: Detail. Image by David Strang.

Figure 23. Stick Chart workshop - gravitational force mapping @ Flowing with the City workshop, Edinburgh. 06.2016: Detail. Image by David Strang.

Figure 24. Stick Chart workshop - electrical signal mapping @ Flowing with the City workshop, Edinburgh. 06.2016: Detail. Image by David Strang.

Figure 25. Stick Chart workshop - people flow mapping @ Flowing with the City workshop, Edinburgh. 06.2016: Detail. Image by David Strang.

Figure 26. Thinkering unSymposium program, Plymouth. 06.2016: Detail. Image by David Strang.

Figure 27. Performance preparation for Morton Riis' workshop on Transduction @ Thinkering unSymposium, Plymouth. 06.2016: Detail. Image by David Strang.

Figure 28. Live Coding performer from Shelly Knotts' workshop on Live Coding @ Thinkering unSymposium, Plymouth. 06.2016: Detail. Image by David Strang.

Figure 29. Performance program for evening of noise performance @ Laundromat by the Sea, Leicester. 12.2016: Detail. Image by David Strang.

Figure 30. Close up image of Elastic Band Drone Machine with pick up coils, transducers, and mini FM broadcaster for performance @ Laundromat by the Sea, Leicester. 12.2016: Detail. Image by David Strang.

Figure 31. Update version of LED Transmitter replacing audio transformer with capacitor and resistor. 07.2017: Detail. Image by David Strang.

Figure 32. Sketch of instructions for LED Transmitter build. 07.2017: Detail. Image by David Strang.

Figure 33. Hotwire~ workshop participants building transmitters. 07.2017: Detail. Image by David Strang.

Figure 34. Mini FM transmitter with line input. 07.2017: Detail. Image by David Strang.

Figure 35. Workshop participants @ Springs and Coils workshop, ISSTA conference. 09.2017: Detail. Image by David Strang.

Figure 36. Entangled springs, transducer, and coil machine exploring resonance and vibration, ISSTA conference. 09.2017: Detail. Image by David Strang.

Figure 37. Testing of mini FM transmitters, ISSTA conference. 09.2017: Detail. Image by David Strang.

Figure 38. Layout of objects and materials for dataLess objects workshop @ dataAche conference, DRHA. 09.2017: Detail. Image by David Strang

Figure 39. Workshop board that participants experimented upon @ dataAche conference, DRHA. 09.2017: Detail. Image by David Strang

Figure 40. Evening transmission and coils building workshop @ dataAche conference, DRHA. 09.2017: Detail. Image by David Strang.

Figure 41. Dirt interference with laser light and audio transducer. Jiangnan University, Wuxi, China. 04.2018: Detail. Image by David Strang

Figure 42. Testing transmission+interference in student group installation. Jiangnan University, Wuxi, China. 04.2018: Detail. Image by David Strang

Figure 43. Students testing sound through interference of light. Jiangnan University, Wuxi, China. 04.2018: Detail. Image by David Strang

Figure 44. Workshop participant experimenting with dust and objects. ISEA 2019, Gwangju, South Korea. 06.2019: Detail. Image by David Strang.

Figure 45. Mixing of dust, vibration motor, solar cell, and transducer. ISEA 2019, Gwangju, South Korea. 06.2019: Detail. Image by David Strang.

Figure 46. Laser light and dust interference. ISEA 2019, Gwangju, South Korea. 06.2019: Detail. Image by David Strang.

Figure 47. Early LED Transmitter. 07.2014: Detail. Image by David Strang.

Figure 48. Following step-by-step instructions in an early transmission+interference workshop @ Di-Egy Fest 0.1, Cairo, Egypt. 03.2013: Detail. Image by David Strang.

Figure 49. Transmission+Interference: Digital Synesthesia installation, Vienna, 03.2016: Detail. Image by David Strang.

Figure 50. An exploded view of Shimano bike gears showing the immediate neighbour connections. Detail. Image by <https://www.novak-adapt.com/catalog/transmission/transmission-parts/sm465-parts>

Figure 51. LED DrumMachine: this version on a breadboard allows for live hacking of the 555 timer circuit. Changing the resistors physically during playing will alter the range of blinking frequency in the LED output. 08.2015: Detail. Image by David Strang.

Figure 52. Circle Draw machine. A small mirror spinning off axis on a DC motor draws out lines of red laser light that are shone upon its surface. When this circle of light crosses a solar cell a sound frequency is produced determined by the speed of the motor. 07.2014: Detail. Image by David Strang.

Figure 53. Installation view of *Fragile Territories* (2016) by Robert Henke. Exhibited at Loop Conference, Berlin. 11.2016: Detail. Image by David Strang.

Figure 54. LED Flicker machine. 08.2015: Detail. Image by David Strang.

Figure 55. Collection of dust interfering with laser light. 04.2018: Detail. Image by David Strang.

Figure 56. Elastic Band Drone Machine setup for live performance. The transducer is to the right of the image (circular metal object) providing sound feedback onto the machine's surface. 12.2016: Detail. Image by David Strang.

Figure 57. Live performance of Light Entropy. 2014: Detail. Image by Peninsula Arts, University of Plymouth.

Figure 58. Schmitt Trigger circuit using noise as input source. Detail. Image by <https://www.learningelectronics.net/VA3AVR/gadgets/555/555.html>

Figure 59. The *LED Flicker* (2015) machine. Pink LED attached to a geared motor, 2 solar cells (one beneath the LED and motor and one to the right, above the LED) contained in a small box. 08.2015: Detail. Image by David Strang.

Figure 60. LED Throwies being constructed, Graffiti Research Lab. No Date: Detail. Image by <https://graffitiresearchlab.com/blog/projects/led-throwies/>

Figure 61. Coils used as FM broadcasters from ISSTA (2017) workshop, 09.2017: Detail. Image by David Strang.

Figure 62. LED DrumMachine fixed version soldered on prototype board. 08.2015: Detail. Image by David Strang.

Figure 63. Shannon and Weaver's Mathematical Theory of Communication (1948). Detail. Image by https://www.researchgate.net/figure/Shannons-communication-model-1948-381_fig1_311551808

Figure 64. transmission+interference: digital synesthesia installation, Vienna. 03.2016: Detail. Image by David Strang.

Figure 65. Back of the receiver in the transmission+interference: digital synesthesia installation, Vienna. 03.2016: Detail. Image by David Strang.

Figure 66. Close up of text displayed on LCD screen, transmission+interference: digital synesthesia installation, Vienna. 03.2016: Detail. Image by David Strang.

Figure 67. Diagram mapping the transmission of text as sound and colour within light. 03.2016: Detail. Image by David Strang.

Figure 68. Extract of text by Linnaeus after Radix Sort algorithm. 2014: Detail. Image by David Strang.

Figure 69. An 8-bit string identifying both the Most and the Least significant bit. 12.2022: Detail. Image by David Strang.

Figure 70. Capture of Strang's face having been processed as sound and transmitted in light. 2015. Detail. Image by David Strang.

Figure 71. dustCrackler (for Hess). 06.2019: Detail. Image by David Strang.

Figure 72. Dust Circuit. An oscillator circuit with feedback resistor left open with two wires. 06.2019: Detail. Image by David Strang.

Figure 73. Laser light reflecting from a hacked cassette tape player. 08.2015: Detail. Image by David Strang.

Figure 74. transmission+interference workshop mess. 08.2015: Detail. Image by David Strang.

Figure 75. transmission+interference workshop mess. 04.2015: Detail. Image by David Strang.

Figure 76. Fontana Mix, Cage, 1958. Detail. Image by <https://www.artnet.com/artists/john-cage/fontana-mix-light-gray-qAuVkrb5lZ-s5SBcbFfuTw2>

Collaborations

The practice of this research involves 3 core artistic projects (of which the outcomes are detailed in Chapter 1.2: Practice: Workshops, Exhibitions, Performances). These projects involved different collaborations which are detailed here.

1. Transmission+Interference

- Collaboration with Vincent van Uffelen.
- Van Uffelen is a co-founder of *transmission+interference* with David Strang
- Roles include: workshop organizing, workshop running, technical making and programming, performing, presenting at conferences, and writing papers.
- Each of these roles are equally shared across the project between Strang and van Uffelen.

2. RADIX

- Collaboration with Deborah Robinson and Simon Rundle
- Robinson and Rundle and are both co-founders of *RADIX* with David Strang
- Roles include:
 - Robinson: artist, researcher
 - Rundle: scientist, researcher
 - Strang: artist, researcher
 - these roles combined for writing journal papers, exhibiting installation works, and giving presentations.

Each collaborator contributed equally to the production of these outcomes.

3. Stick Charts

- Collaboration with Rocio von Jungenfeld and Vincent van Uffelen
- Workshop group developed from mutual research interests of all 3 members
- Roles include: workshop running, workshop organizing, research, and presenting
- Each of these roles are equally shared across the collaboration by van Uffelen, von Jungenfeld, and Strang.

Chapter 1: Introduction: Methodology and Practice

1.1 Methodology

This practice-as-research thesis operates across the fields of theoretical discourse and practical making that have emerged as a result of posthumanist thought and practice. This research includes qualitative insight developed from object-oriented ontology (OOO), machine-oriented ontology (MOO), new materialism, and Doing It With Others (DIWO) that actively explore non-anthropocentric approaches to the creative arts where the human is de-centered to enable a rich discourse where objects and machines (and all that flows in-between) are understood through their capacity to affect and influence the world.

The practice of this research sits within the field of sonic arts and new media arts and operates within a DIWO framework that has been developed in response to the limitations of DIY methods that traditionally individualise the creative genius rather than take into account the many factors of influence over the creative experience. Both DIY and DIWO methodologies here are influenced by Open Source practices and methodologies that open up the creative making experience through models of openly sharing work, tools, and techniques. These frameworks of DIWO and Open Source are incorporated within hands-on workshops for the purposes of creating new machines for creating sound and light for performances and installation. These methodologies are the most appropriate for the development of bespoke noise machines that explore the use of everyday objects and materials through hands-on making and hacking. Hacking, here, is understood as a productive, creative practice that enables an exploration of the unknown potential of an object or machine. This

practice builds on the shared making and hacking practices developed through tools such as Arduino that have, themselves, been developed from Open Source and sharing practices. Incorporating the use of such tools (Arduino) into the practice offers not only technological development of machines for performance but also offers a great wealth of knowledge that has developed through the extensive network of communities sharing and creating new knowledge and skills. Open Source tools establish knowledge that is accessible and available to build upon and it is through the use of open practical and theoretical workshops that this is applied throughout this research.

The workshops require careful planning to appeal to certain individuals with certain levels of skills and knowledge in the appropriate field of practice, however, there should be room for unexpected developments (noise) to arise, in fact, this is encouraged. Noise is a methodological tool within this research that operates to open up new and unexpected paths of creativity and knowledge. It is not only an element of interest in the sonic or visual world of this research but is utilised as an aspect that enhances knowledge and technical skills. Planning for the unexpected is difficult but by opening up the workshops to practitioners beyond my field of study and knowledge the research embraces the core aspect that it requires: interdisciplinarity. Workshops presented at conferences (such as ISEA) were made open to artists, musicians, writers, programmers, and engineers with an interest in technological arts and experimenting with physical objects for making sound. The calls were made through the conference networks which established a base context through the understanding of the scope of, for example, ISEA. Further workshops

developed through the network of Hotwire~ (an interactive arts consortium established by Prior and Strang) were opened to the broader reach of anyone interested in hacking and making practices within the context of sonic and media arts. This meant for a wider range of technological knowledge and skills and broader field of disciplines mixing together. Through these approaches noise increasingly became part of the making process.

The practice of workshops functions as a method to generate and share new knowledge and skills that will be used in the development of performances and installations that will directly feedback into the development of further workshops. This creates a loop of information generated between exhibiting and performing new work that then feeds discourse around the themes of the work in workshops, where the work is remixed and appropriated according to new parameters being defined at subsequent workshops and events. This methodology explores a particular model of cybernetic feedback loops and resonance that, in turn, are part of the discourse of the practice. To further this analogy, the workshop is a machine operating within an assemblage (or larger machine). Certain flows and energies are required as inputs to the machine from the participants and these resonate or flow (in or out of phase) with the feedback from exhibitions and performances to create, appropriate, or hack new potentialities.

The methodology for this research has developed to incorporate flat ontologies, such as OOO and Alien Phenomenology (Bogost), that aim to realign the hierarchical positioning of humans and nonhumans but not in an effort to reduce

every 'thing' to the level of being the same. This methodological approach of ontologically flattening the space between humans and objects enables an encountering of the differences that exist between all things. This difference is central to the posthumanist discourse emerging from Karen Barad's development of *agential realism* (2007) that introduces two key elements to the research: diffraction and intra-action. Barad's discourse around the position of the human within posthumanism impacts the making of this thesis as the aim is not to completely remove the human object or replace it but instead to adjust to other objects and their influential powers as Barad clearly states, 'I am not interested in postmodernist celebrations (or demonizations) of the posthuman as living testimonies to the death of the human' (2007, p. 136). Barad's *agential realism* is a posthumanist mix of the human *with* other objects, living or non living, and to perform this requires an embracing of the differences between all things (diffraction) and an understanding of the hidden potential powers of things that are only realised through their mixing with other things (intra-action). Both the practical and theoretical approaches to the making of this research are entangled in encountering difference and the new potential that arises through intra-actions between things, whether they are motors, LEDs, texts, concepts, dust, or sound.

1.2 Practice: Workshops, Exhibitions, Performances

The purpose of this section of the thesis is to outline the specifics of the practice of this research so as to develop a clear map of when events happened and what took place at those events. The events include:

- conferences
- performances
- workshops
- exhibitions
- talks / presentations
- unSymposium

The practice of this research has developed across the variety of these event types as well as across different artistic projects involving different collaborations (see Collaborations section). This section details the different artistic projects and the different outcomes emerging from within those projects. These projects are:

- transmission+interference (Strang and Van Uffelen)
- RADIX (Robinson, Rundle, and Strang)
- Stick Charts (Strang, Van Uffelen, and Von Jungenfeld)

Of these projects listed above, *transmission+interference* is the core practice that features throughout the entirety of this research. Both *RADIX* and *Stick Charts* operate to support the research of *transmission+interference* through practice.

This section links to the online folder of documentation for this thesis which is shared here (last modified Tuesday 14th February 2023 @ 22:03):

[Documentation of Practice](#)

2014 - Starting Point

Prior to this stage *transmission+interference* had been established and it is upon this base that the following research is developed from. The research began with the early version of the *LED Transmitter* already in place. The *LED Transmitter* took an audio signal as input to an LED, via an audio transformer, that then transmitted it towards a solar cell attached to an audio speaker / mixer. LED Transmitter and solar cell receiver.

The following 3 images show the first versions of the LED Transmitter that used:

- battery pack
- audio transformer (1,000-ohm -> 8-ohm)
- audio input connection
- LED
- wiring



(Fig. 1. LED Transmitter on perforation board)

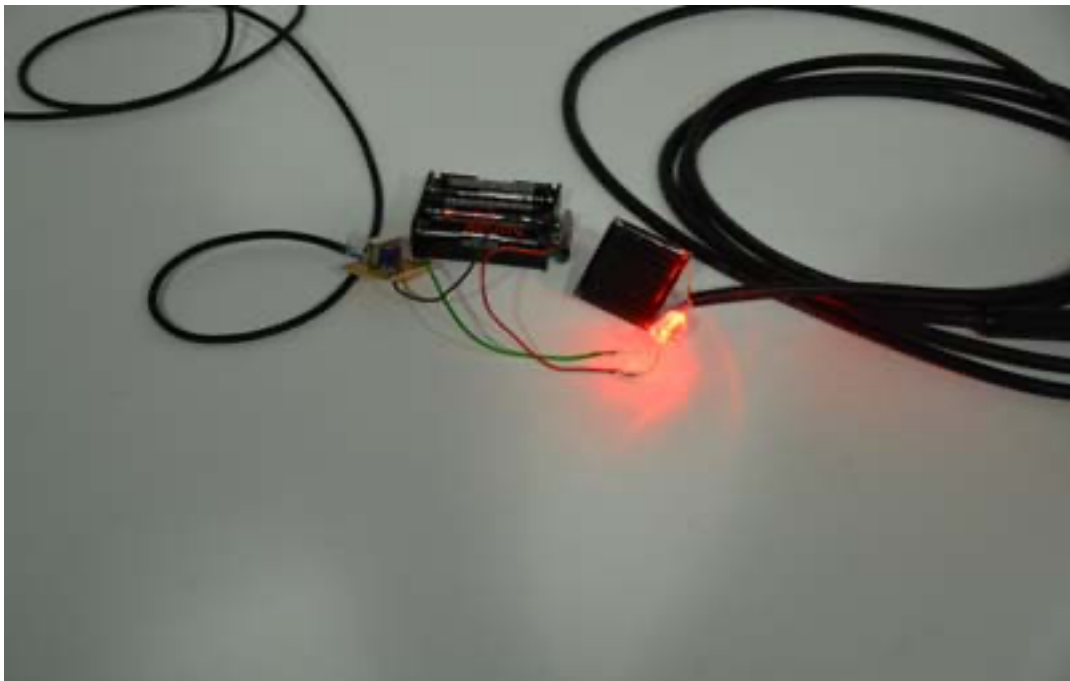

(Fig. 2. Led Transmitter)

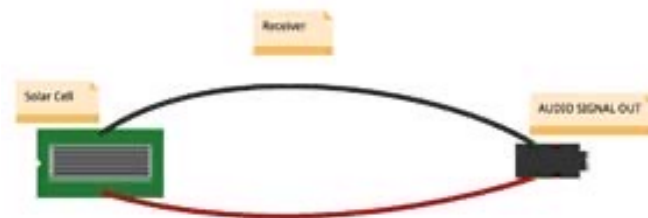
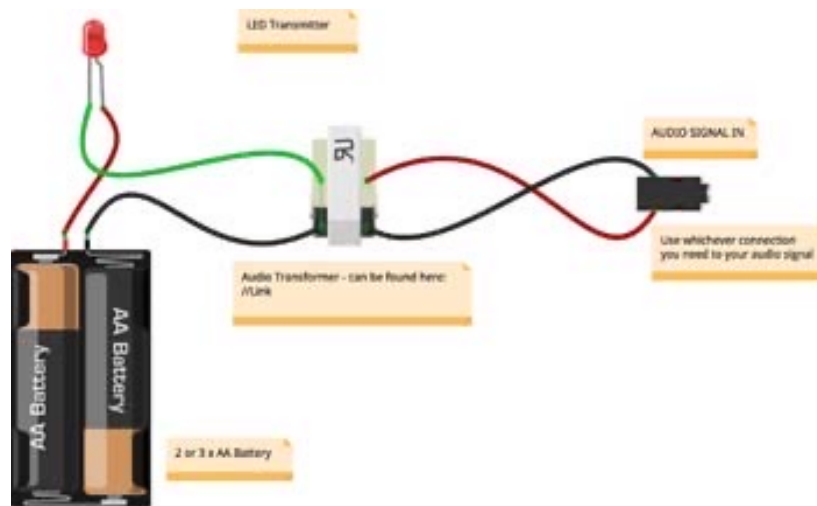

fritzing

(Fig. 3. LED Transmitter and Receiver build instructions with audio transformer)

Fig. 1. shows a soldered version creating a fixed point of transmission. Fig. 2. shows a version with the LED loose on wires for ease of movement. These two versions allowed for different types of positioning around the solar cell receiver.

The receiver is made of:

- solar cell
- audio output connection
- wiring

First Workshops

It is important to initially introduce an environment that was established to deliver practice-based, hands-on workshops called *Hotwire~* (Prior and Strang, 2014 - 2019) as various workshops for this research were run as part of its program of events. *Hotwire~* was an interactive arts consortium co-founded by David Strang and Dr. Andrew Prior that ran from 2014 - 2019. The aim of *Hotwire~* was to run workshops where participants would learn through doing and making with objects and materials and code. It was initially established as a way to break from the hierarchical practices of teaching in a university setting to flatten the space between professors, lecturers, and students. Workshops were developed and presented by anyone involved in the group.

Documentation of some *Hotwire~* events is available online here: <https://h0tw1re.wordpress.com/>

- **Hotwire~ Workshop #1 ~~ Speaker Hacking / Victorian Synthesiser - 14.10.2014**
- <https://h0tw1re.wordpress.com/2014/10/14/workshop1-speaker-hacking-victorian-synthesizer/>
 - Online Documentation Folder: [2014_Hotwire](#)
 - Contents: 2 x .webp stills
 - Documentation shows: workshop group building and working with objects and close up of a hacked speaker with foil, battery, spring, and cables.
 - Workshop leader: David Strang and Andrew Prior
 - Where: Bread and Roses pub in Plymouth, UK

- 8 participants
- Call for participants: online via Hotwire~ network
- This workshop was the first instance of exploring everyday materials, materials that are readily at hand - they only need to be conductive to signal. The starting point was taken from *Handmade Electronic Music: The Art of Hardware Hacking* (2009) by Nicolas Collins that outlines a method for twitching speakers with batteries, and an instrument by John Bowers called *The Victorian Synthesiser* that develops feedback through conductive material placed in the cone of an upturned speaker.
- This workshop was designed for developing open workshop practices and understand how to break down instructor / learner hierarchies.

This workshop developed:

- ideas around shared experiences with and through objects / materials and sound
- possibilities with materials for making new sounds
- running workshops without set instructions of what to do beyond the initial setup

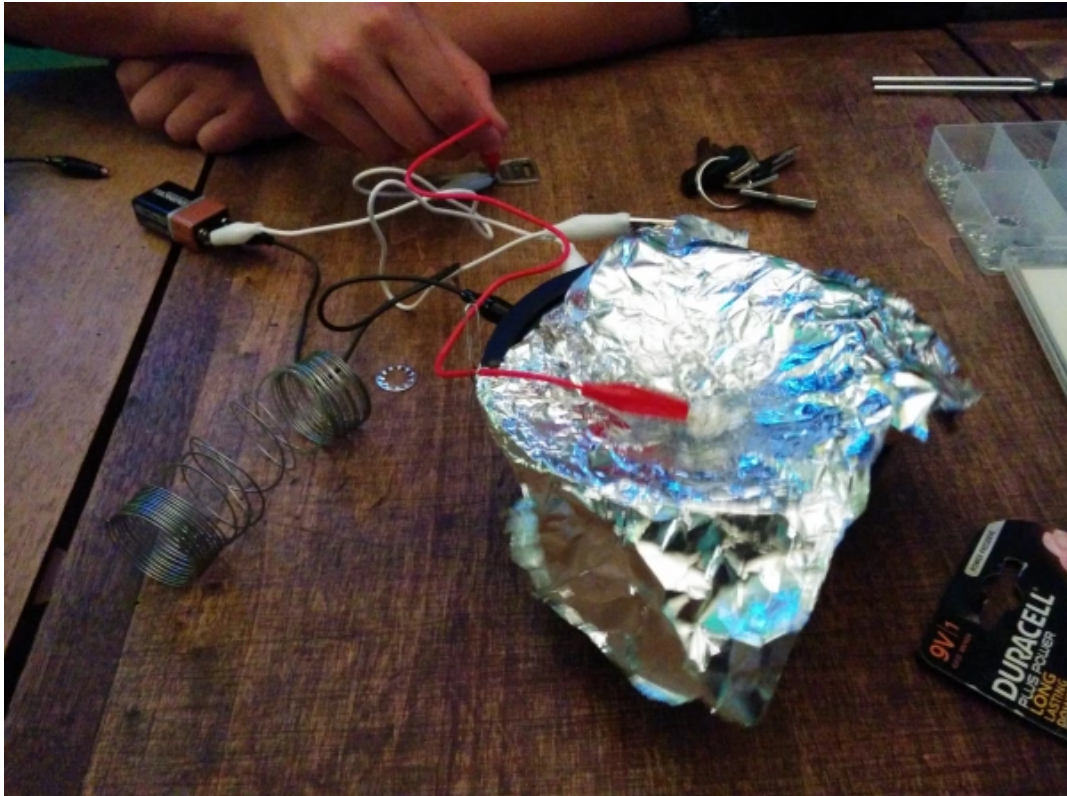

(Fig. 4. Speaker Hacking workshop at Hotwire~)



(Fig. 5. Hotwire~ workshop. Plymouth, 10.2014)

- **Hotwire~ Workshop #3 ~ Live Coding - 09.12.2014**
- <https://h0tw1re.wordpress.com/2014/12/09/workshop3-live-coding/>
 - Workshop leader: David Strang
 - Where: Bread and Roses pub in Plymouth, UK
 - 9 participants
 - Call for participants: online via Hotwire~ network
 - This workshop was designed to develop similar workshop skills as the above workshop mentions but this was developed through code and sound, not physical objects / materials. Various live coding languages were introduced to the group (ixi Lang, Tidal, Gibber, and Sonic Pi) before collectively choosing to explore ixi Lang due to its ease of use and quick learning curve. This workshop developed further the concept of running or leading a workshop where hierarchies are reduced - beyond introducing the coding environment the workshop group was then able to collectively establish an understanding of how to run code, create sounds, rhythms, and improvise with code.
 - How participants responded to each others sound output and surprising sound events when evaluating unknown code was a learning point.
 - It became clear through a code / laptop only workshop how vital the role of physical matter and objects was becoming in the research. Live coding offers a great immediacy to producing sound but there is a barrier that exists with coding that is less present with physical objects

- fear of not knowing appears greater with code than with a rubber band or paper clip.

- 2015

• Hotwire~ Live #1 - Performance - 10.02.2015

<https://h0tw1re.wordpress.com/2015/02/10/performance-1/>

- Online Documentation Folder: [2015_Performance-MikeBlow](#)
 - Contents: 2 x .jpg, 1 x .WAV
 - Documentation shows: images of performance setup and sound recording direct input from mixing desk.
- Performers: Mike Blow and David Strang
- Where: Bread and Roses pub in Plymouth, UK
- Live performance with Mike Blow combining two different sets of machines for performance. For *transmission+interference* I introduced the following machines alongside Mike Blow's use of effects pedals and oscillators:
 - Elastic Band Drone Machine
 - Circle Draw
 - Disc Spinner
- The aim of this performance was to explore levels of control with the machines, to understand how they operate in performance settings.



(Fig. 6. Performance Setup view from David Strang's side of table)



(Fig. 7. Performance setup view from Mike Blow's side of table)

- **Hotwire ~ Workshop #6 ~ Elastic Band Drone Machines - 14.04.2015**

<https://h0tw1re.wordpress.com/2015/04/14/workshop6-elastic-band-drone-machines/>

- Online Documentation Folder: [2015.04_Hotwire](#)
 - Contents: 9 x .jpg
 - Documentation shows: a build of the EBDM and the workshop group exploring the machine to make sound.
- Workshop leader: David Strang
- Where: Bread and Roses pub in Plymouth, UK
- 7 participants
- Call for participants: Online via Hotwire~ network

- This is the first *transmission+interference* workshop based upon the use of the Elastic Band Drone Machine (EBDM). I introduced the EBDM in its basic setup:
 - wood platform
 - nails
 - elastic bands
 - vibration motors
 - LED
 - Arduino

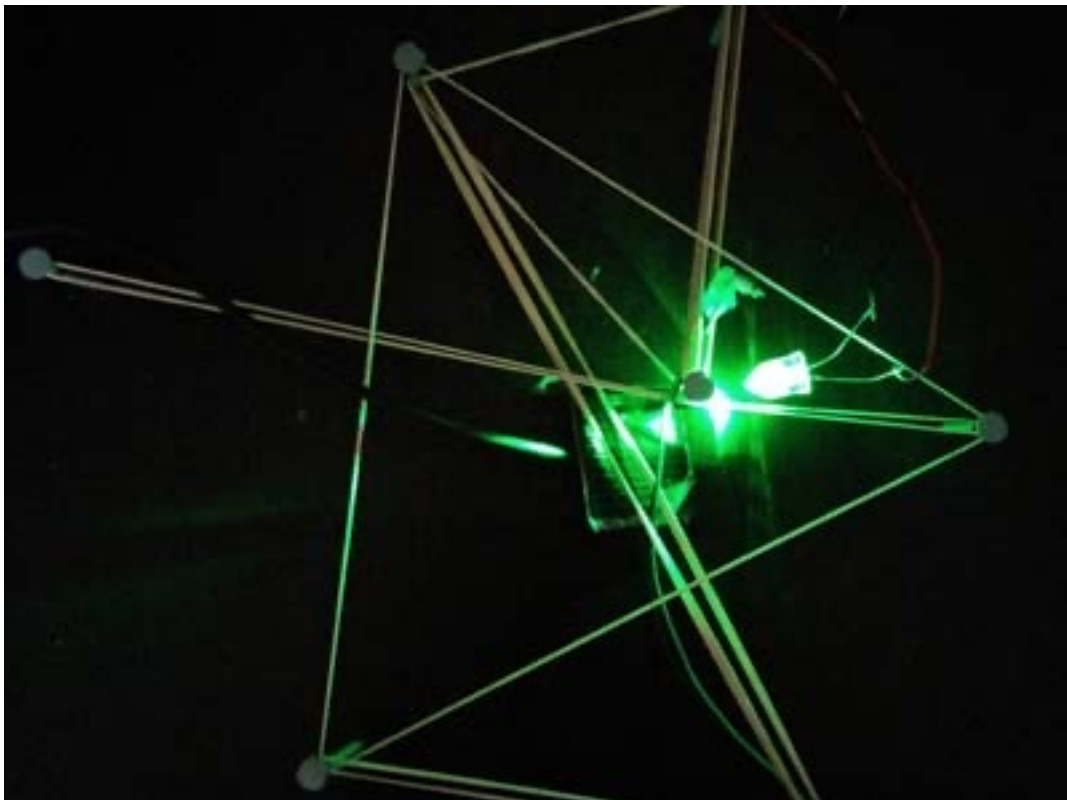

(Fig. 8. Elastic Band Drone Machine)

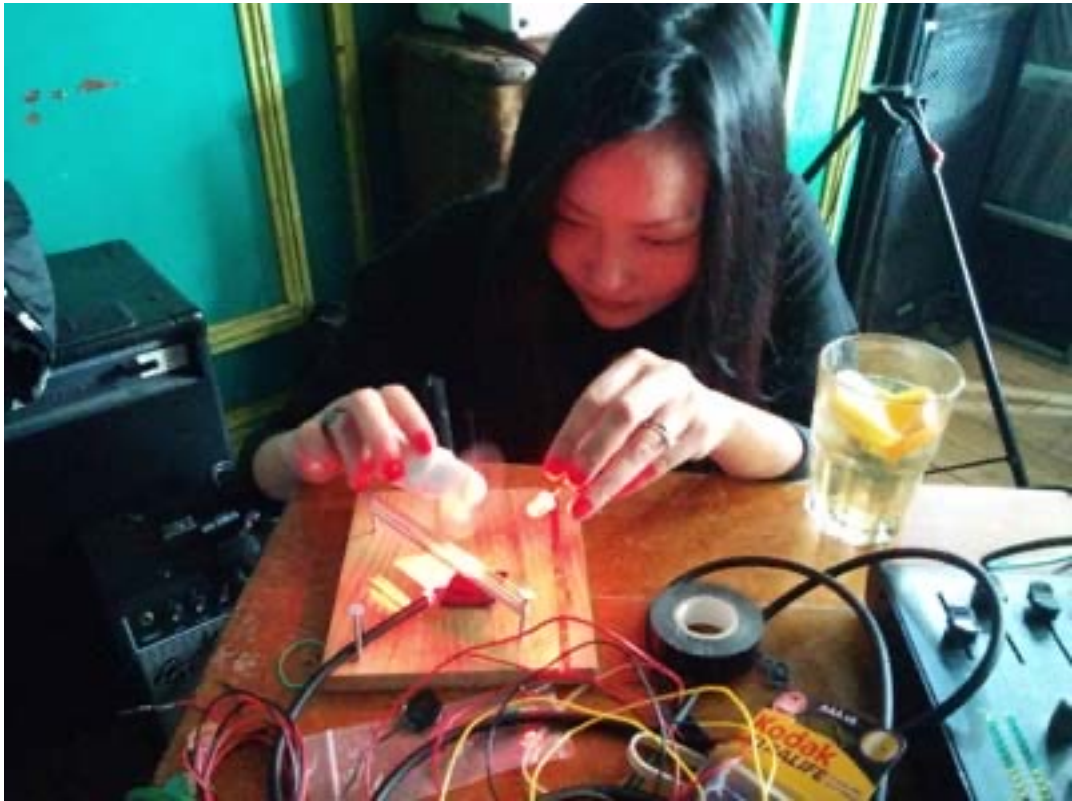

(Fig. 9. Hotwire~ workshop)



(Fig. 10. Hotwire~ workshop)



(Fig. 11. Table view of Hotwire~ workshop)

- The aim of this workshop was to specifically focus on preparing the EBDM for performance (a performance was setup for 2 days later).

Exploring:

- collective performance
- EBDM design
- materials and objects for sound

- **Hotwire~ Live #2 - Performance - 16.04.2015**

<https://h0tw1re.wordpress.com/2015/04/16/performance-2/>

- Performers: David Strang and Hotwire~ workshop group
- Where: Bread and Roses pub in Plymouth, UK

- The performance was the output from the workshop run 2 days previously and performed by the group.
-

- **Workshop @ Media City 5 conference - 05.2015**

- Online Documentation Folder: [2015.05_MediaCity](#)
 - Contents: 56 x .jpg, 1 x .mp4
 - Documentation shows: building and testing with materials (paper, card, plastic) and light and shadow in daytime workshop. In the evening the group is shown intervening in the city using the fixtures of light and some other media objects, for example, the use of tiny motors that are installed on the bottom of pedestrian crossing 'wait' signs.
- Workshop Leaders: David Strang, Vincent van Uffelen, Rocio von Jungenfeld
- Where: University of Plymouth
- 4 participants
- Call for participants: through conference and Hotwire~
- The aim of this workshop was to hack the city and play with the light that already exists in the media of the city. Instead of introducing new lights and media into an already busy environment questions about how to use existing light fixtures were raised. Shadow, reflection, and masking were explored.

- This workshop developed further practices of workshopping and collective operating with objects and materials. It also developed practices of working directly with the materiality of light.
- Exploring the turning motors that are hidden beneath pedestrian crossing 'wait' signs was a further development of the concept of hidden signals - the city hides certain information, only open to some (the motors are helpful for blind people to feel and know when to cross) which links to steganography.

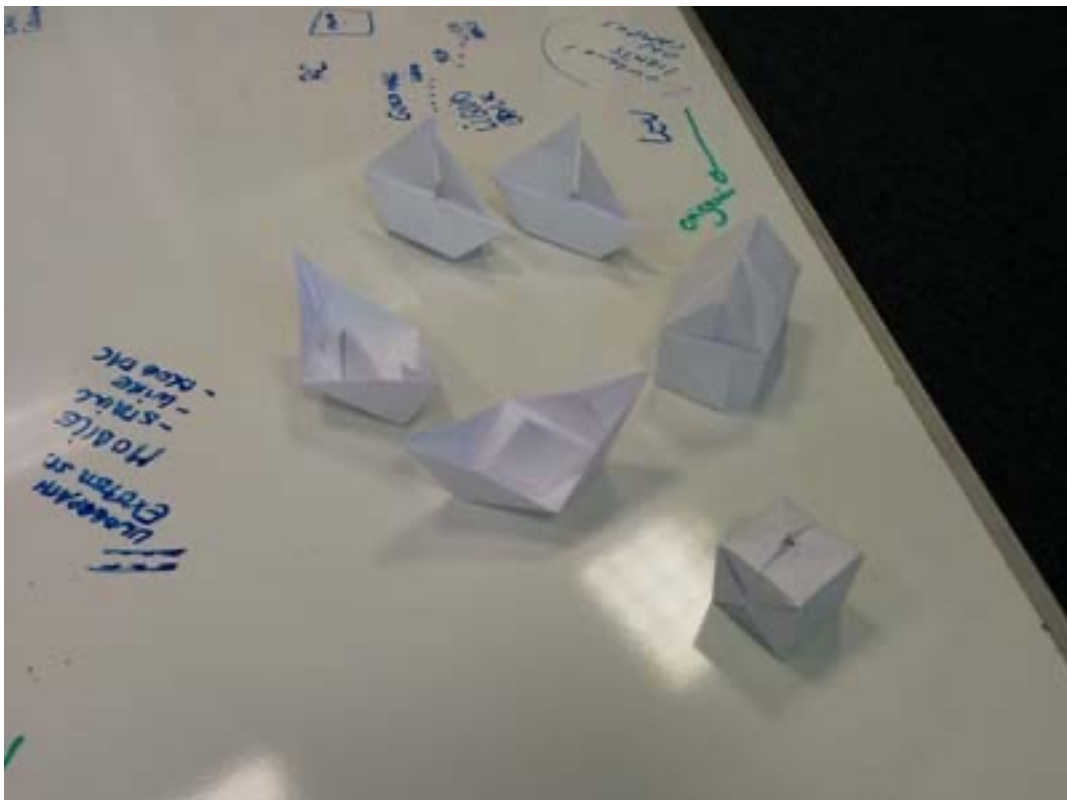

(Fig 12. Preparing materials in workshop)

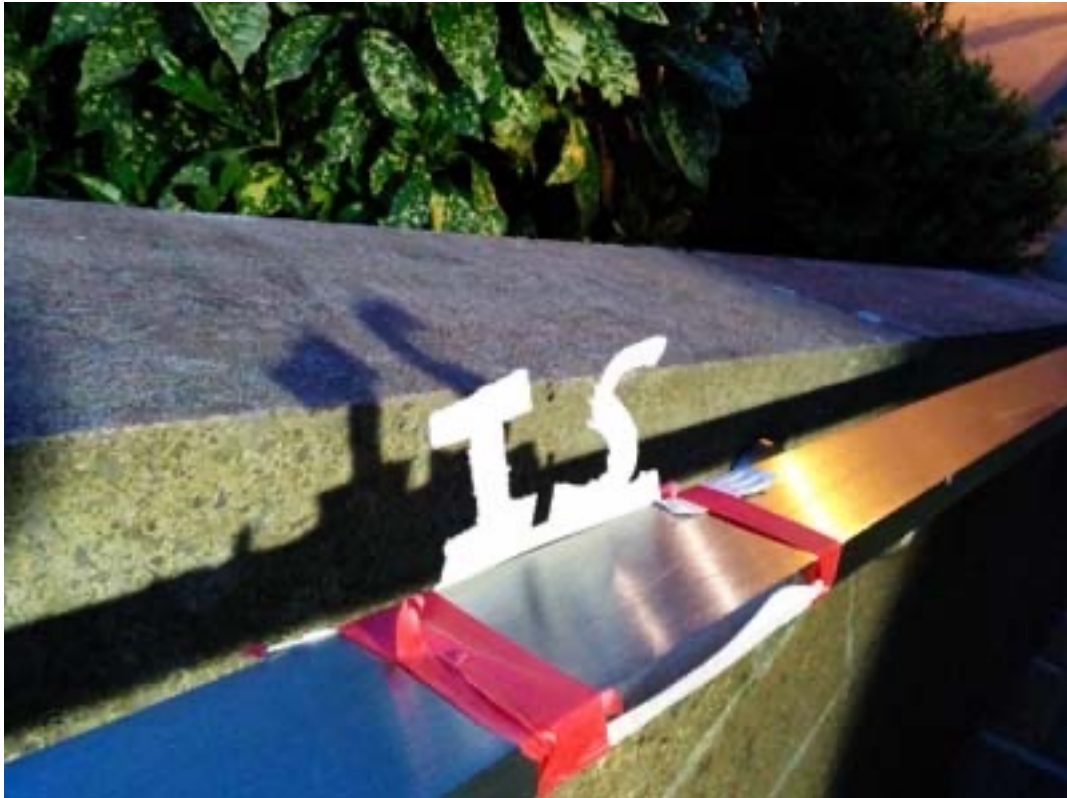

(Fig 13. Intervention in evening - installing objects to play with light in the city on hand rails)



(Fig. 14. Intervention in evening - installing objects to play with light in the city on floor lighting fixtures)



(Fig 15. Intervention in evening - marking out shadow lines with chalk)

- **Workshop @ ISEA 2015 Disruption - 08.2015**

<https://isea2015.org/program/workshops-and-tutorials/#transmission>

- Online Documentation Folder: [2015.08_ISEA-Vancouver](#)
 - Contents:
 - Audio: 4 x .wav
 - stills: 29 x .jpg
 - Video: 3 x mp4, 3 x .MOV
 - Strang_David_ISEA2015 conference paper
 - Documentation shows: still images from across the duration of the workshop. Two images

(20150814_ISEA_W01_TransmissionInterferenceDay1_DavidStrang_JL_003 and 20150814_ISEA_W01_TransmissionInterferenceDay1_DavidStrang_JL_004) show the very start of the workshop where the room was initially laid out for formal delivery of information that we collectively changed after introducing the workshop. The images show build and development of EBDM, Disc Spinners, and LED Drum machine. Video files show the testing of machines and the audio files are closing group performances by members of the workshop.

- Workshop Leader: David Strang
- Where: SFU, Vancouver, Canada.
- 2-day workshop with closing group performance
- 11 participants
- Call for participants: through conference site
- This workshop demonstrated all *transmission+interference* machines developed to date with a focus on how to develop any of them. This workshop involved processes of re-making machines to explore new potential. Participants were able to collectively build existing machines with a view to augment them or propose new machines in response.
- Day 1:
 - introducing the research project and various materials in relation to sonic arts

- building existing machines and exploring how they work
- Day 2:
 - participants brought new materials and objects into the workshop
 - transducers were collectively explored on the Elastic Band Drone Machine
 - A small group worked with 555 timers to explore new control of LEDs and square wave oscillator sounds
- The outcomes from this workshop were:
 - developing use of physical transducers on surfaces
 - LED DrumMachine
 - 555 timer circuits to build noise circuits
 - 555 timer circuits to control LED rhythms



(Fig. 16. Workshop group - Transmission+Interference workshop @ ISEA 2015, Vancouver)



(Fig. 17. Disc Spinner - Transmission+Interference workshop @ ISEA 2015, Vancouver)



(Fig. 18. Workshop group - Transmission+Interference workshop @ ISEA 2015, Vancouver)

2016

- **Exhibition - Digital Synesthesia - (Vienna) 03.2016 + (Hong Kong) 05.2016**
- <https://digitalsynesthesia.net/wp/>
- <http://www.davidstrang.co.uk/transmitds.html>
- Vienna: <https://digitalsynesthesia.net/wp/events/digital-synesthesia-exhibition-opening-vienna-march-10-2016/>
- Hong Kong: <https://digitalsynesthesia.net/wp/events/digital-synesthesia-hong-kong/>
 - Online Documentation Folder: [2016_digital_synesthesia](#)
 - Contents:
 - [digital_synesthesia_catalogue.pdf](#)

- DigitalSynesthesia:
 - Cases, Catalog, Code, Electronics, Floorplans, PCB, Plinth, Poster
 - Exhibition_Vienna_2016.03: 33 x .jpg
 - Exhibition-HongKong_2016.05: 37 x .jpg
 - Install-Vienna_2016.03: 24 x .jpg
 - Testing-London_2016.03: 14 x .jpg
 - The documentation folders ('Exhibition...') details both exhibitions (Vienna and Hong Kong) opening. The 'Testing...' folder shows some early tests of the installation. 'Install-Vienna...' shows the installation being installed for first exhibition. The 'DigitalSynesthesia' folder contains all work in the build and presentation of the work from Arduino code, electronics schematics through to installation poster. Also included is the text for the exhibition catalogue.
- Commissioned artwork: Transmission+Interference: Digital Synesthesia
- Artists: David Strang and Vincent van Uffelen
- Where: University of Applied Arts, Vienna
- Where: ISEA 2016 Cultural R>evolution, Hong Kong
- This installation emerged due to a talk I gave at the Synesthesia symposium at ArtLaboratory, Berlin in 2013. I presented the work of

transmission+interference and its overlapping of sound and light and objects.

- This installation focused specifically on the transmission, interference, and reception of light and sound signal influenced by Shannon and Weaver's Mathematical Theory of Communication (1948) questioning whether a communication system can be synesthetic. The installation developed the objects and process of the basic LED Transmitter into an interactive installation. The installation attempted to transmit a text message across the gallery space hidden within light and sound.
- The outcomes of renewed focus in the research from this installation were:
 - development around communication theory - focusing upon Shannon and Weaver's theory
 - signals hidden in plain sight, or steganography.
 - the role of participants as interference, as new objects folding into and out from the installation
 - the role of noise in revealing new information (text based information theory (Shannon entropy))



(Fig. 19. Transmission+Interference: Digital Synesthesia installation @ ISEA 2016, Hong Kong)



(Fig. 20. Transmission+Interference: Digital Synesthesia installation @ Digital Synesthesia exhibition, Vienna)

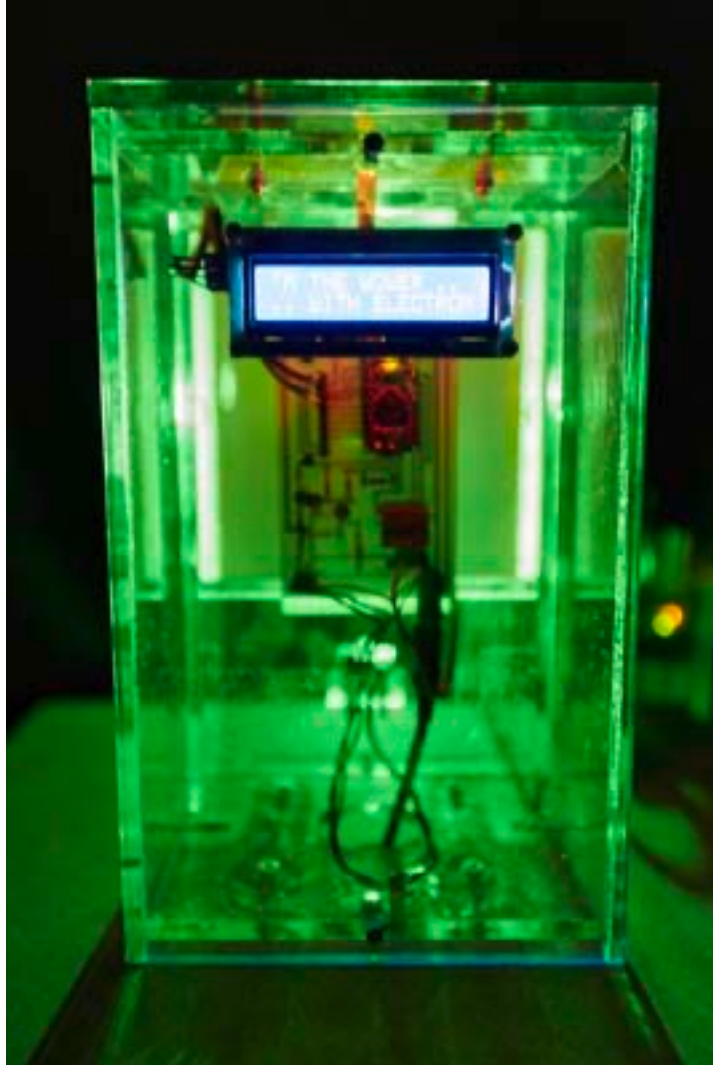

(Fig. 21. Transmission+Interference: Digital Synesthesia receiver module @ Digital Synesthesia exhibition, Vienna)

-
- **Workshop + Seminar - Stick Charts @ Flowing With the City - 06.2016**
 - Online Documentation Folder: [2016.06_stickCharts](#)
 - Contents:
 - flowingCity_A5.pdf
 - stills: 33 x .jpg

- Documentation shows: A5 document as part of call for participants. Stills show workshop outputs, working with materials, ideas and thoughts on shared posters.
- Workshop Leaders: David Strang, Vincent van Uffelen, Rocio von Jungenfeld
- Where: University of Edinburgh, UK
- 4 participants
- Call for participants: through University of Edinburgh postgraduate seminar series
- Workshop aimed at the use of low-tech materials and objects to map the complex flows and energies of the city. Mapping practice was inspired by the use of physical vibration, resonance, and materials available to hand of Polynesian sailors in the creation of stick charts to navigate the seas around island bays.
- The aim of this workshop was to focus on the workshop as a practice in its own right - not to develop an exhibition or performance but to demonstrate the development of new knowledge emerging collectively through working with objects.
- The physical outcomes were maps of gravitational energy, WiFi signal, people, and heating systems with basic non-computational, non-sound, non-light based materials. Coils featured in this workshop building up the influence of this on the practice that led to workshop at ISSTA in 2017.

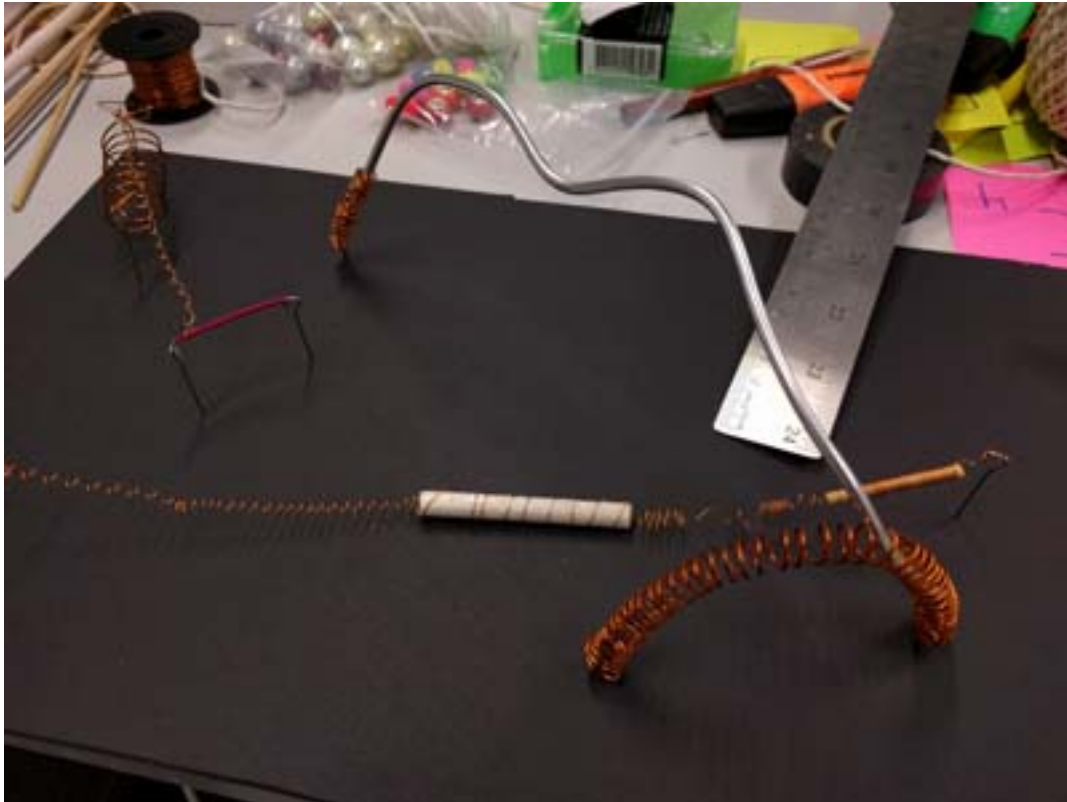

(Fig. 22. Stick Chart workshop - electrical signal mapping)

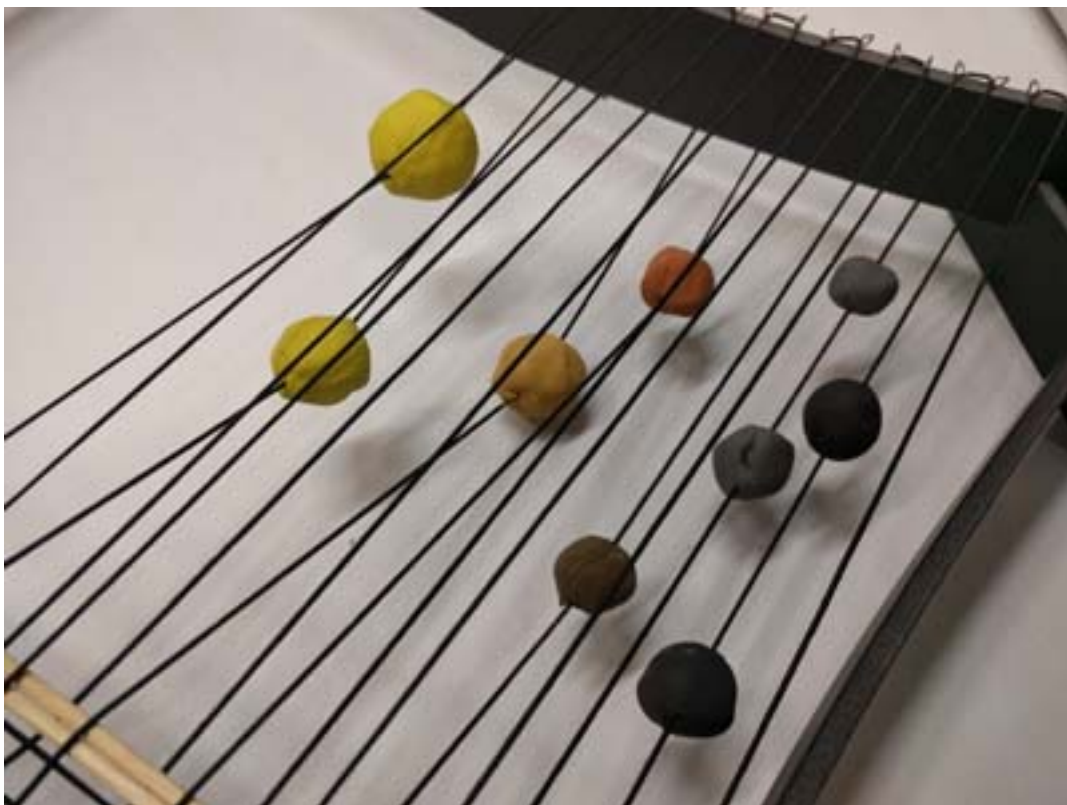

(Fig. 23. Stick Chart workshop - gravitational force mapping)

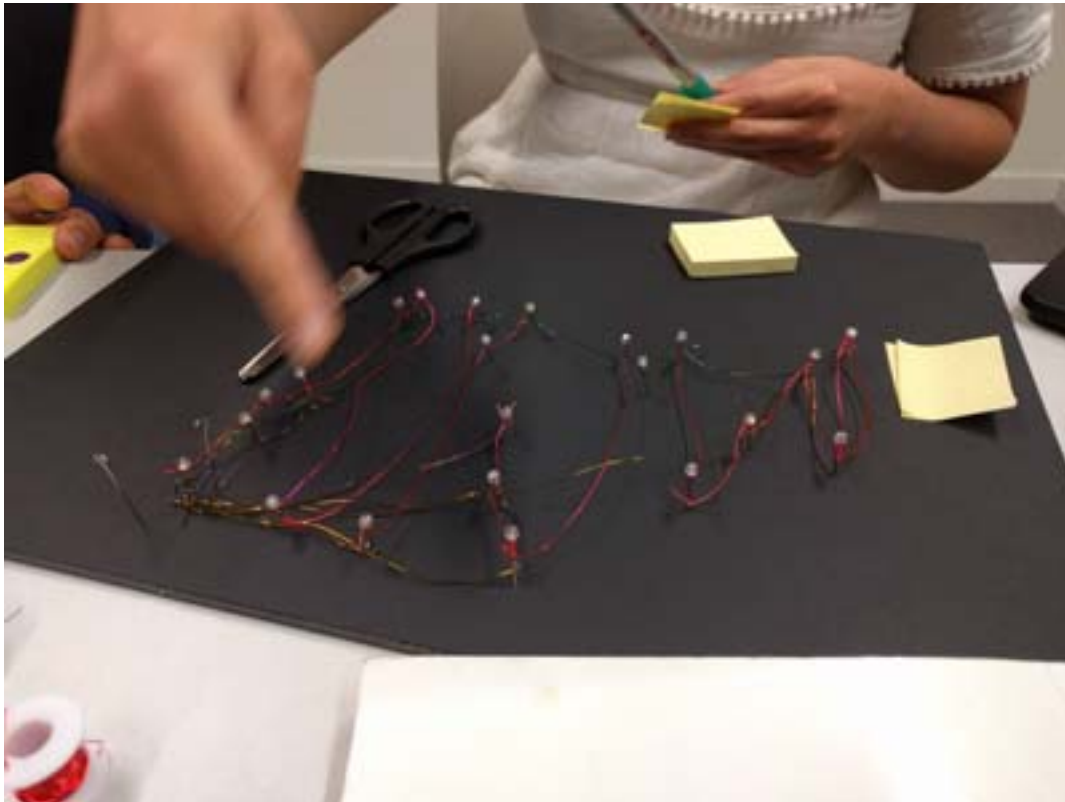

(Fig. 24. Stick Chart workshop - people flow mapping)

- **Hotwire~ Thinkering unSymposium - 06.2016**

<https://hotwire.wordpress.com/2016/06/09/thinkering-unsymposium/>

- Online Documentation Folder:

[2016.06Hotwire_thinkeringUnsymposium](#)

- contents: 8 x .jpg
- Documentation shows: A5 program for event, group working with modular synthesis in David Bessell's workshop, performance setup on floor for Morton Riis' Transduction workshop and distributed participants from Shelly Knotts' Live Coding workshop performing on their laptops.

- unSymposium organised by Andrew Prior and David Strang
- Where: Royal William Yard, Plymouth, UK
- Call for participants: through Hotwire~ network and University of Plymouth (i-DAT, media arts, fine arts, and computer music)
- Invited 3 workshop leaders to run 1-day workshops exploring the concept of thinkering. Outputs from each workshop presented in live performance.
- Workshop leaders: Shelly Knotts (Live Coding), Morton Riis (Transduction), and David Bessell (Modular Synthesis)
- Developments from this unSymposium were renewed focus on show don't tell aspects of workshopping. How not to *use* objects and materials but instead to *work-with* objects and materials to develop performance outputs



(Fig. 26. Thinkering unSymposium program)



(Fig. 27. Performance preparation for Morton Riis' workshop on Transduction)



(Fig. 28. Live Coding performer from Shelly Knotts' workshop on Live Coding)

-
- **Performance - Laundromat by the Sea - 12.2016**
 - Online Documentation Folder: [2016.12_landromatbythesea](#)
 - Contents: 10 x .jpg
 - Documentation shows: close ups of EBDM setup for performance with coils, transducers, miniFM. Screen of the event listing performers. Space of the performance.
 - Performer: David Strang
 - Where: DeMontfort University, Leicester, UK.
 - One evening of performances by noise artists organised by John Richards and Yan Jun. Based on a provocation text by Yan Jun - *The Laundromat by the Sea* (2014)
 - Performance explored Elastic Band Drone Machine as a solo platform for performance introducing developments from workshop at ISEA 2015 with the use of transducers on the surface of the machine to fold in physical vibration feedback.
 - Secondary exploration in the work was inclusion of coils as mini FM transmitters as well as resonant springs. This set up a direction with the practice that led to the workshop at ISSTA in 2017.



(Fig. 29. Performance program for evening of noise performance - Laundromat by the Sea)

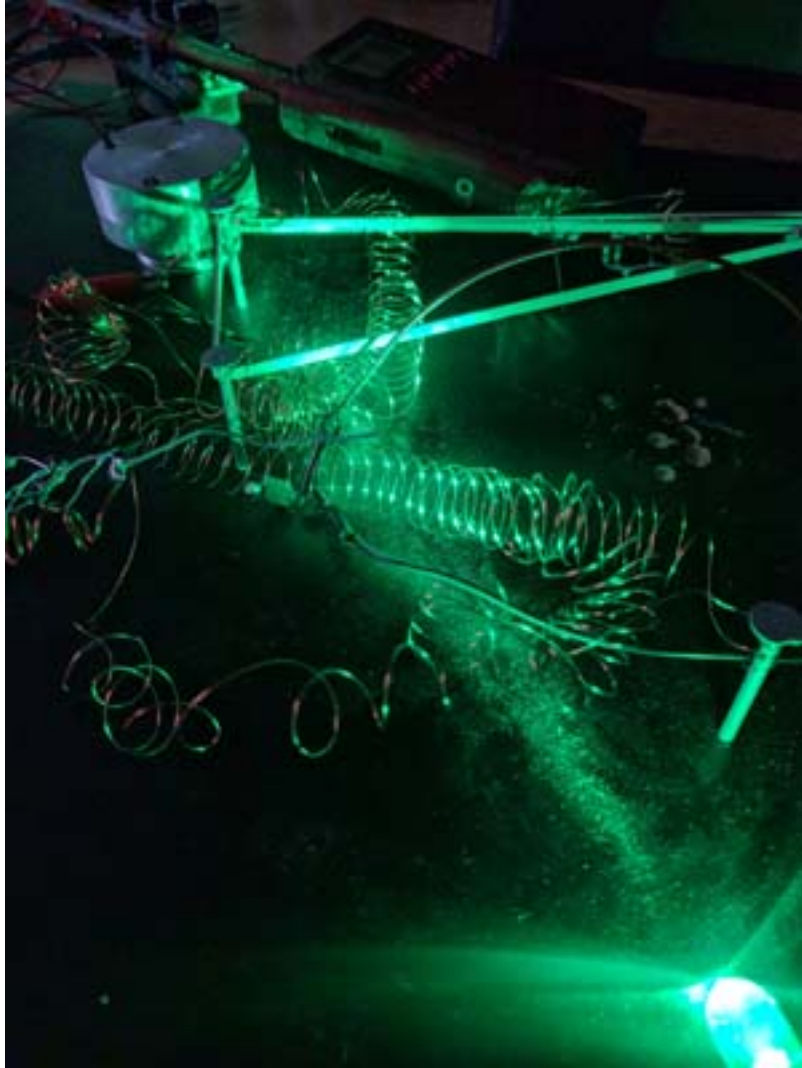

(Fig. 30. Close up image of Elastic Band Drone Machine with pick up coils, transducers and mini FM broadcaster for performance @ Laundromat by the Sea)

2017

- **Exhibition - Noisy Embryos - 04.2017**

<https://collaborativenoise1.wordpress.com/noisy-embryos/>

<http://www.davidstrang.co.uk/noisyembryos.html>

- Artists: RADIX (Robinson, Rundle, and Strang)

- Where: Ruskin Gallery, Cambridge for Cambridge Science Festival 2017.
 - The web link shows images of the 9-screen installation at Ruskin Gallery.
 - The artwork created contributes to this research as it explores resonance in the body (the body of a snail - *Radix balthica*) and how that produces affects upon the species. The work folds in research around epigenetics, resonance, and the nonhuman that became further of interest in this research. The exploration of the nonhuman before this work had been based on technical objects (motors, rubber bands) but this repositioned that concept again by opening to other species - an influence also felt from Uexküll. This was the where the thoughts around epigenetics first developed, mainly through discussion between us all (1 marine biologist (Rundle) and two artists)
 - Rundle's scientific understanding being key to fully grasping the concept.
-

- **Workshop - Hotwire~ transmission. 07.2017**
 - Online Documentation Folder:
[2017.07_Hotwire~transmissionWorkshop](#)
 - Contents: 6 x .jpg

- Documentation shows: new LED transmitter without the use of audio transformers, examples of completed LED transmitter and miniFM coil, workshop group building parts and testing.
- Workshop leader: David Strang
- Where: Bread and Roses pub in Plymouth, UK
- 3 participants
- Call for participants: through Hotwire~ network
- Small transmission workshop re-focusing upon the modes of sound transmission in *transmission+interference* through building newly designed LED Transmitters, without audio transformers, and mini FM transmitters used in previous performance for Laundromat by the Sea.
- This workshop was instruction led - following of schematics to enable a discussion about transmission and the objects involved in developing this practice in a hidden way (steganography)
- Of interest was the use of very similar objects (capacitors and resistors) to cause vibrations in different ways - one through light and another through radio waves.

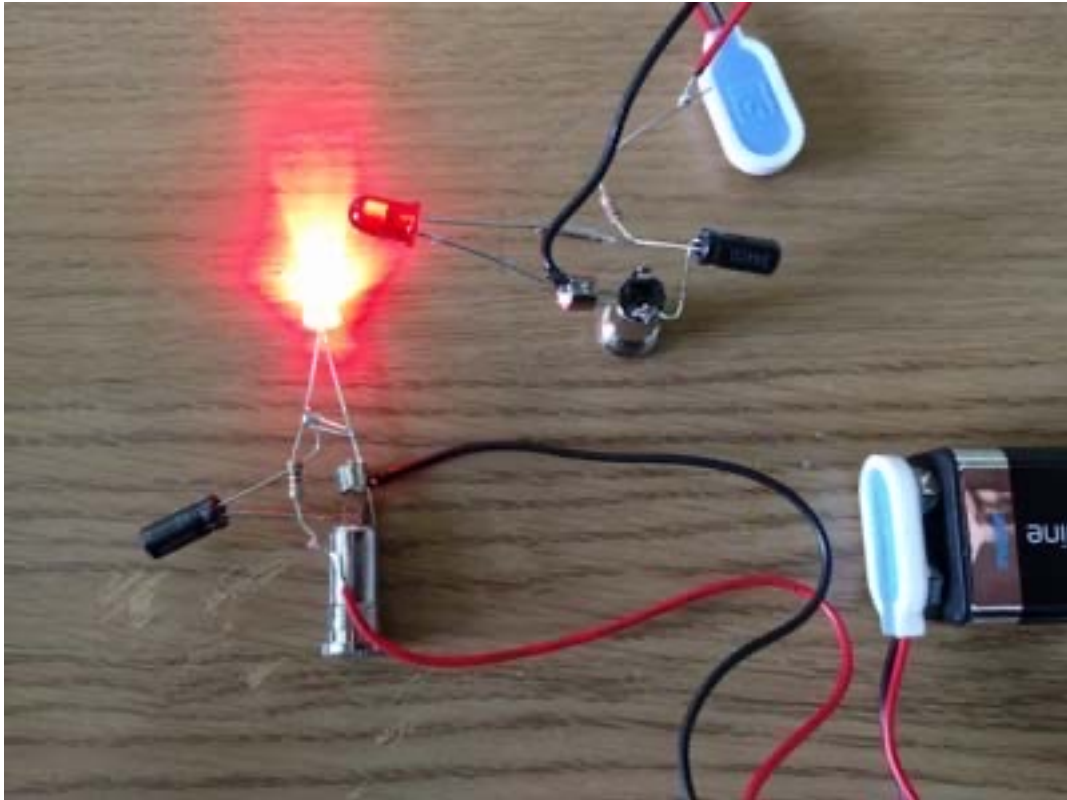

(Fig. 31. Updated version of LED Transmitter replacing audio transformer with capacitor and resistor)

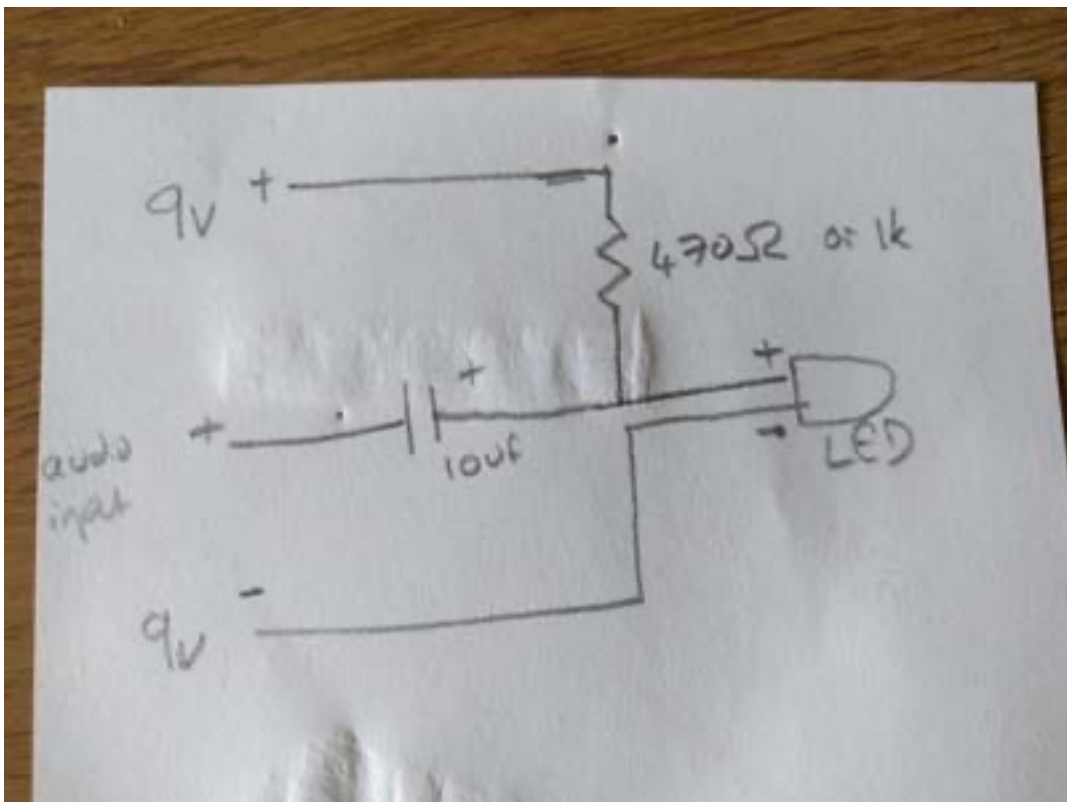

(Fig. 32. Sketch of instructions for LED Transmitter)



(Fig. 33. Hotwire~ workshop participants building transmitters)

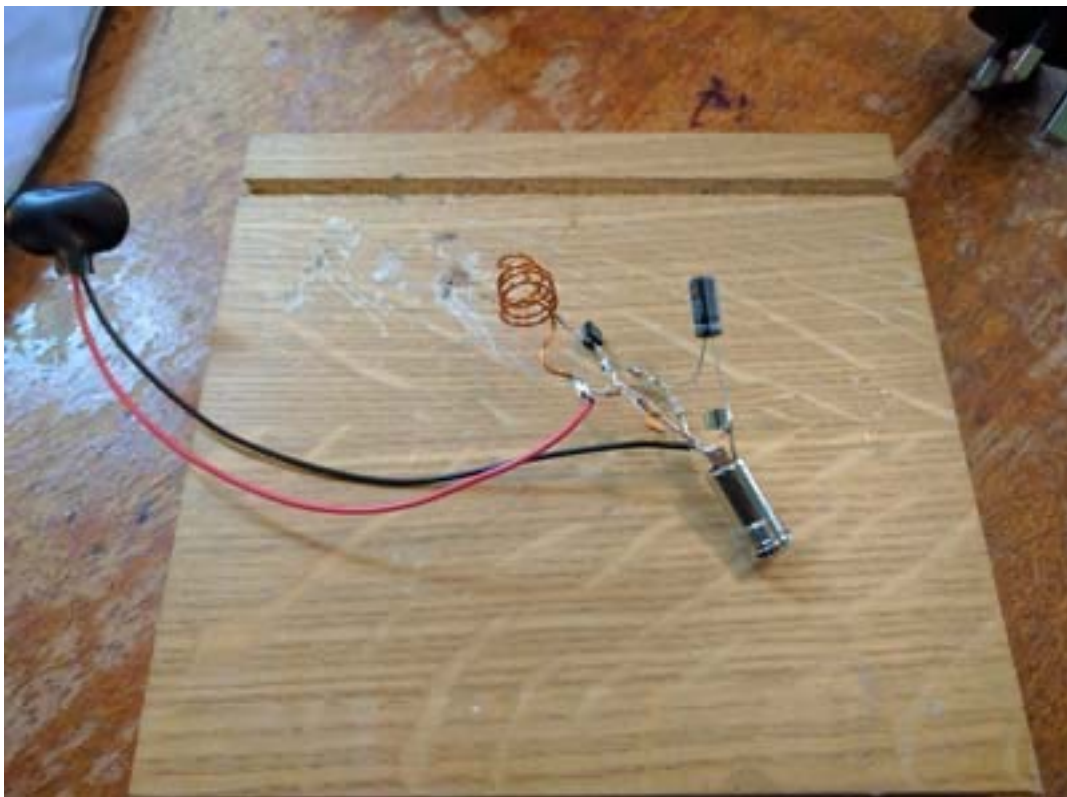

(Fig. 34. Mini FM transmitter with line input)

-
- **Workshop - Springs and Coils @ Irish Sound Science and Technology Association (ISSTA) conference. 09.2017**

<http://issta.ie/issta2017dkit/>

- Online Documentation Folder: [2017.09_ISSTA-springsCoils](#)
 - Contents 26 x .jpg
 - Documentation shows: workshop group building and exploring coils and springs within *transmission+interference* context. One particular outcome shown is a spring tower with transduction and coils for radio interference.
- Workshop leader: David Strang
- Where: Dundalk Institute of Technology
- 11 participants
- Call for participants: through conference site and program
- The aim of this workshop to focus directly on the use of and power of simple coils of wire that can act as resonant springs or magnetic pick up coils or mini FM broadcasters. These were presented to the workshop group in the context of the *transmission+interference* project, using sound and light together as a transmission system with a renewed focus on the concepts of resonance and vibration.
- Coils were explored to understand vibration, resonance, radio interference, spring reverb, and connections to forces of transduction.



(Fig. 35. Workshop participants @ Springs and Coils workshop, ISSTA conference)



(Fig. 36. Entangled springs, transducer, and coil machine exploring resonance and vibration)

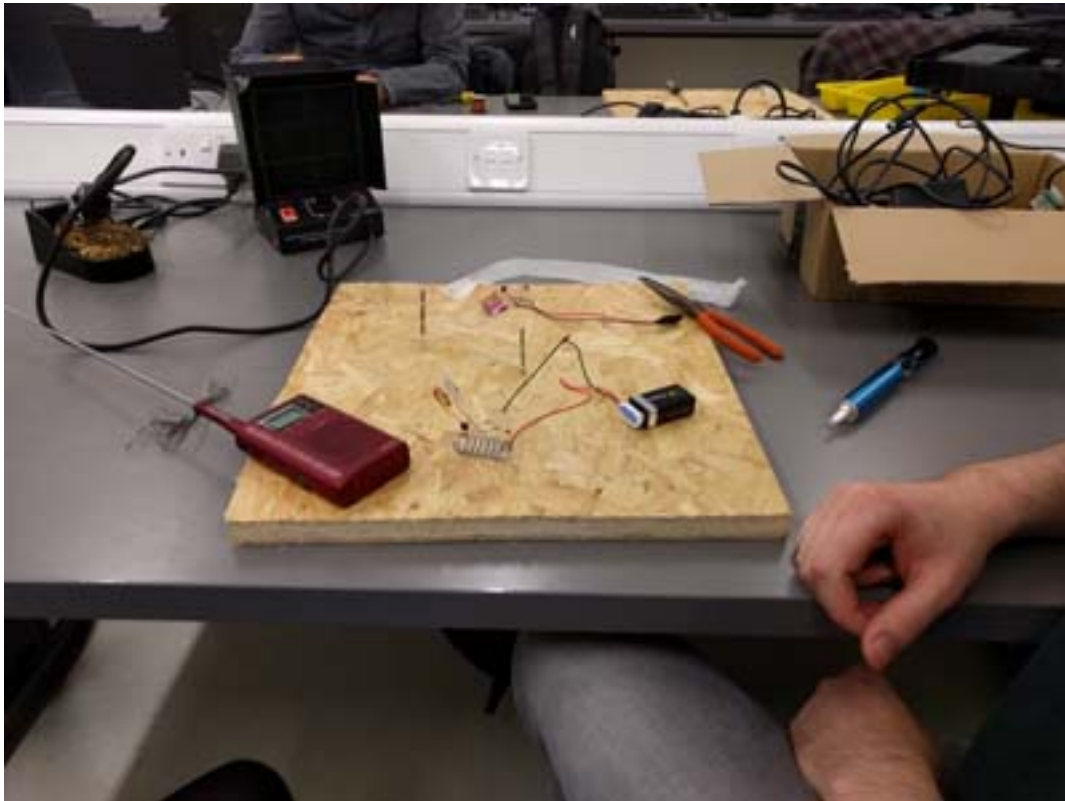

(Fig. 37. Testing of mini FM transmitters)

-
- **Workshop - dataLess Objects @ Digital Research in the Humanities and Arts (DRHA) conference Data Ache - 09.2017**
 - Online Documentation Folder: [2017.09_DRHA](#)
 - Contents: 6 x .jpg
 - Documentation shows: a laying out of objects and parts for building in a physical version of an exploded diagram (see Bogost in Chapter 1: Objects) and close up of a shared playing surface between all participants. Also shown is image of following side workshop in the evening of the conference.
 - Workshop Leader: David Strang

- Where: University of Plymouth, UK
- 3 participants
- Call for participants: through conference site and University of Plymouth
- The aim of this workshop was to explore everyday objects that have no datasheet to realise the potential held within them for sound and noise performance. Questioning what is the data of a sponge or a rubber band or a nail. This workshop used the platform of the Elastic Band Drone Machine to question objects and their hidden potential and it did this with a shared version - 1 EBDM between the group, as it was a small group. The aim was not to create a performance for the conference but instead to really get under the hood of the object. What drives it as a resonant object. This workshop introduced the material of dust as a potential object to explore in future workshops.

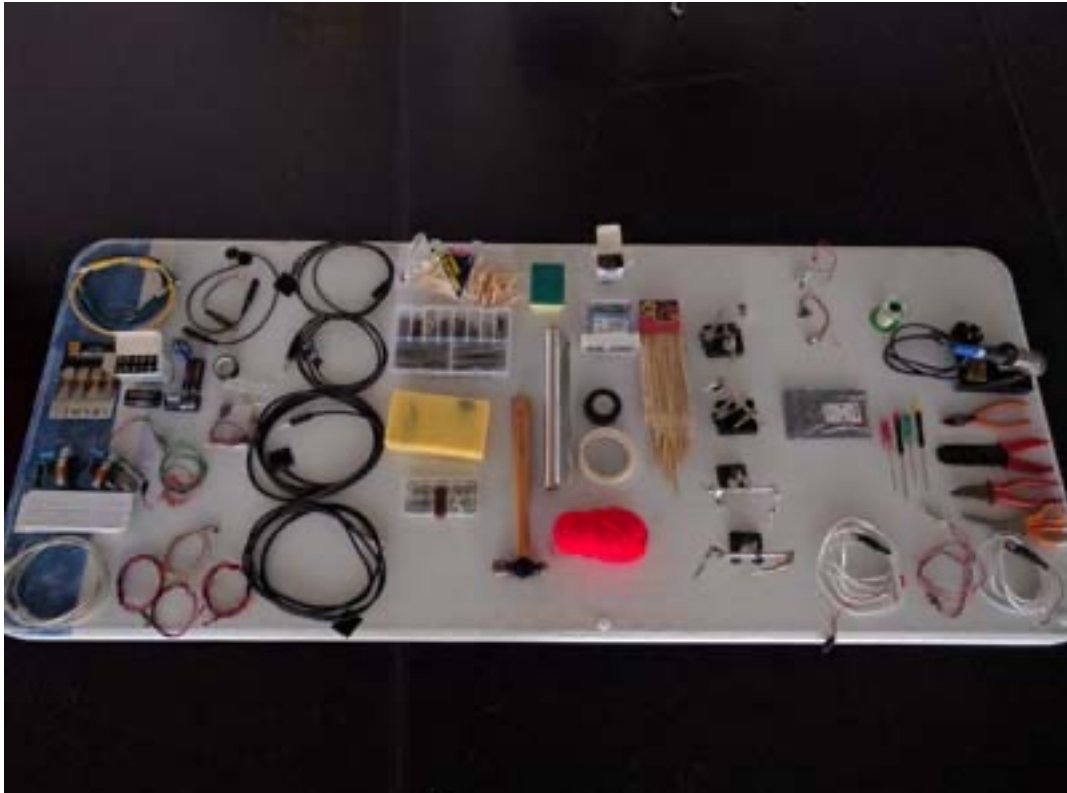

(Fig. 38. Layout of objects and materials for dataLess objects workshop @ dataAche conference)

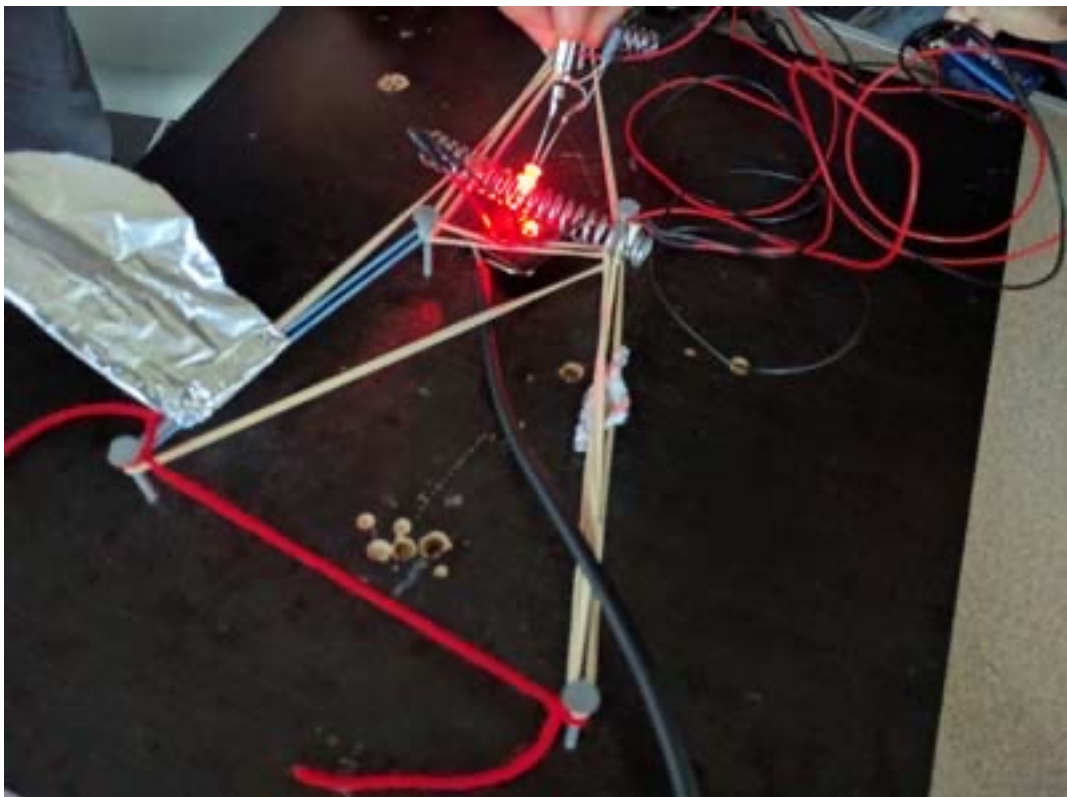

(Fig. 39. Workshop board that participants experimented upon @ dataAche conference)

- **Workshop - Hotwire~ @ Digital Research in the Humanities and Arts**

DRHA conference - 09.2017

- Workshop leader: David Strang
- Where: Bread and Roses pub, Plymouth, UK
- 5 participants
- This side workshop in the evening of the conference was setup to bring in the coils and springs from the previous ISSTA workshop to explore resonance and transmission through mini FM.



(Fig. 40. Evening transmission and coils building workshop @ dataAche conference)

2018

- **Workshop - Transmission+Interference: Dust @ Jiangnan University -**

04.2018

- Online Documentation Folder: [2018.04_Jiangnan-dustWorkshop](#)
 - Contents: 69 x .jpg, 3 x mp4
 - Documentation shows: students building and collectively working on project ideas. Early use of dust and dirt but this is limited (see comment below)
- Workshop leader: David Strang
- Where: Jiangnan University, Wuxi, China
- Duration: 4-days
- 20 participants
- Call for participants: through Jiangnan University postgraduate art and design programs.
- This was a problematic workshop as the building maintenance and cleaning team kept cleaning the workshop space. This presented one unthought of issue in choosing to work with dust and dirt. Regardless, the workshop managed to produce the first developments of dust in *transmission+interference* but they were limited across the workshop group. Instead the group became very interested in everyday objects to build group installations exploring light, reflection, materials, and objects.



(Fig. 41. Dirt interference with laser light and audio transducer)

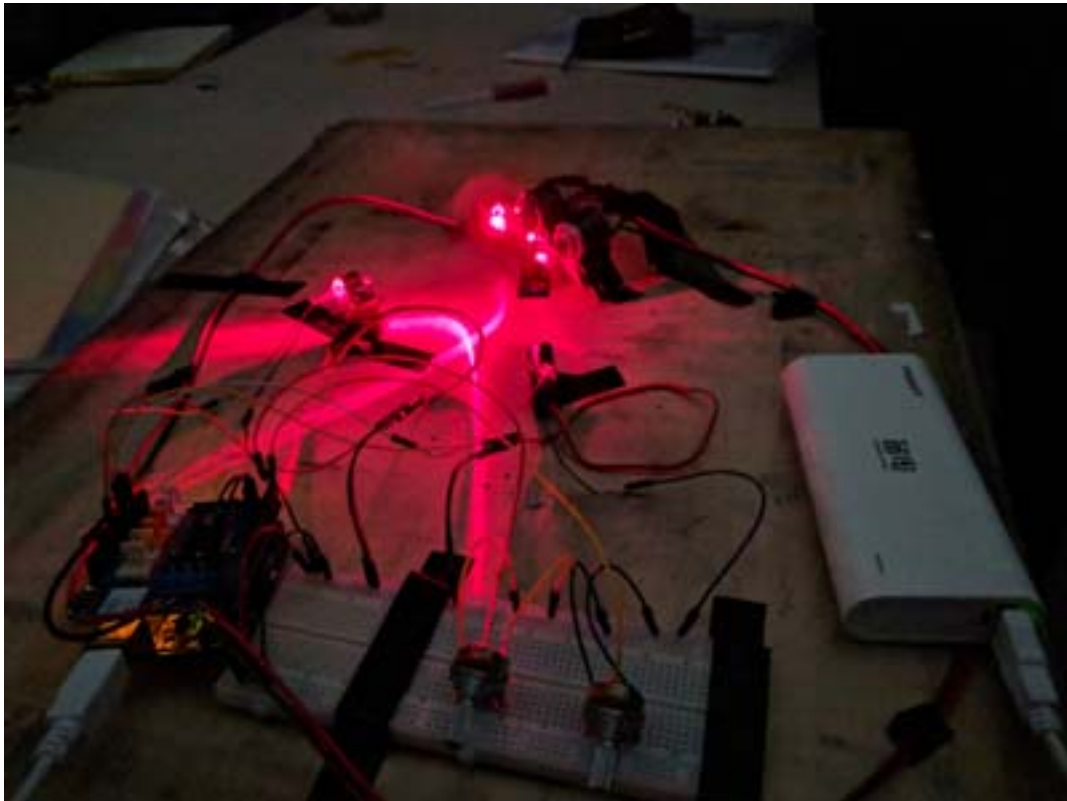

(Fig. 42. Testing transmission+interference in student group installation)



(Fig. 43. Students testing sound through interference of light)

2019

- **Workshop - Transmission+Interference: Dust @ ISEA 2019 Lux Aeterna - 06.2019**

<https://www.isea-archives.org/isea2019/>

- Online Documentation Folder: [2019.06_ISEA-Gwangju](#)
 - Contents:
 - 12 x .jpg,
 - Video folder: 1 x .MOV, 12 x .mp4
 - Dust Circuit folder: 6 x jpg
 - dustCrackler (for Hess): 6 x .jpg, 2 x .MOV
 - Documentation shows: workshop group working with dust and dirt. Also detailed are various project ideas (dustCircuit and dustCrackler (for Hess)) to build and work with dust as objects in the construction of noise machines. Videos show tests of certain ideas created within the group.
 - Workshop leader: David Strang
 - Where: Asia Culture Centre, Gwangju, South Korea
 - 8 participants
 - Call for participants: through ISEA conference call
 - 1-day workshop

- This workshop sought to bring together the many aspects of *transmission+interference* that had been developed to date and explore them all through dust. Dust now offered great creative potential in particular through transduction and as light interference. Having had problems in the previous workshop in Wuxi regarding cleaning of the space I decided to transport some dust collected at home for use in the workshop.
- Realised from this workshop were speculative concepts of dust circuits - using dust as an object in the work, conducting and producing signal

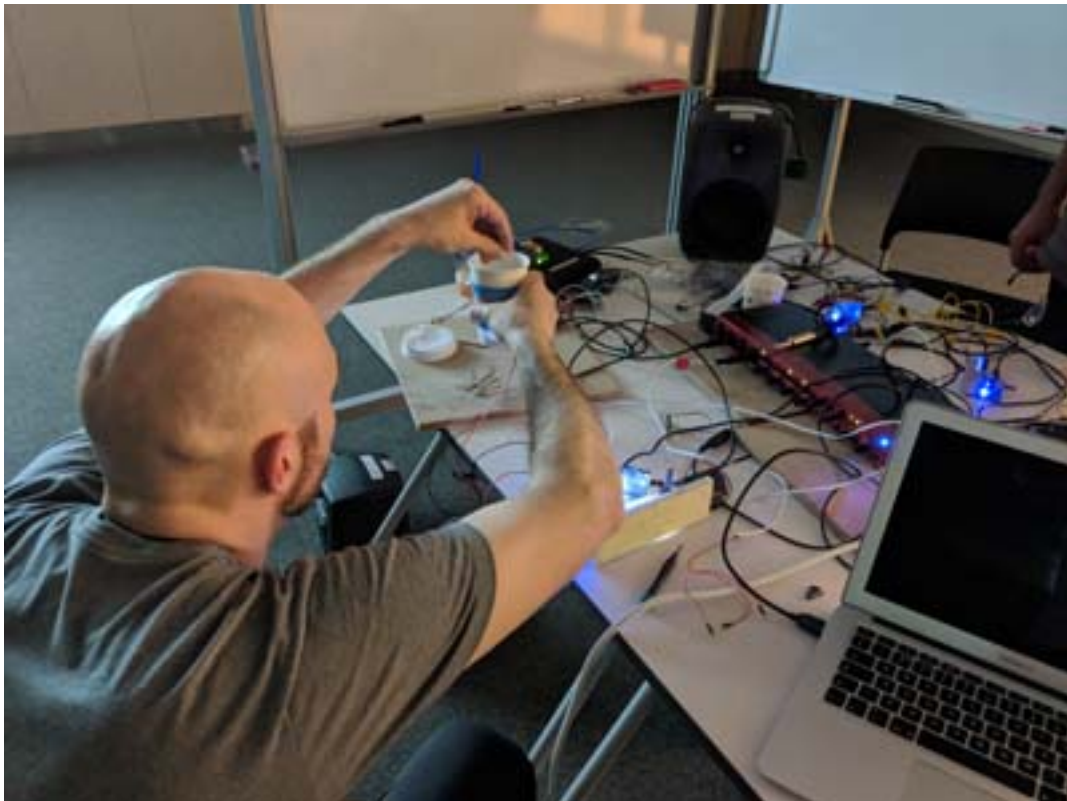

(Fig. 44. Workshop participant experimenting with dust and objects)



(Fig. 45. Mixing of dust, vibration motor, solar cell, and transduction)



(Fig. 46. Laser light and dust interference)

1.3 Practice: Transmitting, Receiving, and Interfering

Keywords: Noise, Interference, Transmission, Making

The aim of this section is to introduce the practical project *transmission+interference* (Strang & Van Uffelen) that is the core practice that weaves throughout the discourse of this thesis. This is in order to develop a practical framework and contextualise the forthcoming arguments around object, noise and workshops. The material processes involved in the development of the practice offer a unique way to question the appropriation of and entanglement of technical objects, the potential of noise and the knowledge sharing capacities of open workshops.

Context

In 1937, John Cage presented his text *The Future of Music: Credo* beginning with the line 'I believe that the use of noise to make music will continue and increase until we reach a music produced through the aid of electrical instruments' (1968, p. 3). This statement has influenced the project of *transmission+interference* in many ways that is explored throughout this thesis including the exploration of technical, material objects, the use of sound, and the making process. Noise is involved in them all and Cage foresaw this. *Transmission+interference* challenges this statement too by suggesting that Cage limited the scope of noise only to make 'music'. In *transmission+interference* noise is what is produced from noise; noise is the intended outcome.

Cage's prediction of the making process being aided by 'electrical instruments' is clear to see in contemporary sound making practices where the computer is a central tool of production and reproduction. *Transmission+interference* continues this concept within 21st Century maker culture and with a focus on how the 'aid' functions between the human and non-human components. In *transmission+interference* the 'electrical instruments' are not only producers of noise (as sound and light), they are the noise of the performance or installation, entangled together, human and non-human. Throughout this thesis there is an investigation of this statement, exploring what emerges through flipping this statement to see how the electrical instruments produce noise through the aid of the human - Cage has introduced this collaboration between humans (although strictly limited to musicians within his discourse) and technical, electronic instruments, albeit with a strong anthropocentric drive that places the human in the centre to which the instruments serve. 21st Century maker culture has developed in such a way as to enable a questioning of this human centred approach - in particular, the development of physical computing (for example, Arduino) and the re-emergence of DIY analog synthesis. Both of these practices (introduced in more detail later) engage in a hands-on, making process with technical objects (electrical components, power voltages, inputs and outputs) and are valuable processes for flattening the hierarchy of knowledge between the human and non-human.

Cage's text continues around a discourse of the technology of the film projector, a technical machine that produces sound through light, celluloid film, pattern, and the photocell, suggesting that this assemblage offers the composer (to use Cage's

term) 'the entire field of sound [and] the entire field of time' (1968, p. 5). This technical machine creates the potential for new sound production and *transmission+interference* continues this process through similar investigations of sound and light and material object. At a similar period of time when Cage presented this text there were many filmmakers materially exploring the medium of film with some of the most exciting results being the developments that intentionally bled information (in the context of film this is the image) across the borders of the visual and sound parts of a strip of celluloid film. Sound is contained on celluloid film down the side strip of the film, next to the main frame containing the image. The sound strip contains the visual waveform of the soundtrack and when the film runs through the projector, a light shines directly through the sound strip onto the surface of a photocell (a resistor that adjusts according to how much light falls over its surface). When the film runs, the waveform printed on the film interferes with this light signal and we hear this interference as the soundtrack to the film. The filmmaker Norman McLaren creatively explored the potential of this as a new producer of electronic sounds by directly drawing shapes (circles, lines, for example) onto the soundtrack instead of a 'traditional' sound waveform. In his film *Dots* (1940) he directly translated the shapes that we see in the image (circles and lines) onto the soundtrack, producing a synesthetic connection between what the audience sees and what it hears. Here McLaren is developing the practice introduced by Cage that still influences artists working in the fields of sonic arts and experimental film today.

To bring this discourse up to date into a timeline that runs alongside the *transmission+interference* project it is useful to introduce the *Tonewheels* (2007 - 2014) project by Derek Holzer. In this project, Holzer produces small electronic machines that creatively explore the technological sound production from film discussed above through an exploration of the transparency and shadow effects that form to modulate a light signal that hits a photocell. In *Tonewheels* performances ‘the linear filmstrip has been replaced with a number of rotating disks, whose speed and design create waveforms of different frequencies and timbres.’ (Holzer, 2019, p. 25) The assemblage of light, photocell, and interfering pattern of transparency and shadow are the same tools as cinematic sound projection and are also the same sound generating components of *transmission+interference*. In addition to the tools and processes used by Holzer, the *Tonewheels* project also frames the practice within the field of sonic arts performance which is where *transmission+interference* is situated. The *transmission+interference* project seeks to distance itself from the field of experimental cinema through the use of alternative objects (e.g. mirrors, elastic bands, dust) in place of the printed celluloid strip (McLaren) or rotating disk (Holzer). However, as this distancing is developed in the work there still will always remain the elements that link back to Holzer, McLaren, and Cage: light transmission, physical (optical) interference, and photocell reception to generate sound.

LED Transmission

‘It certainly is a very extraordinary sensation to hear a beam of sunlight laugh, cough and sing, and talk to you with articulate words.’ (Bell in Kahn, 2013, p. 207)

Transmission+interference emerged through a messy making and hacking process exploring cheap light devices and the concept of transmission to arrive at the core machine upon which the whole practice would be based: the *LED Transmitter*. This machine has encountered changes throughout the development of the practice and these will be uncovered throughout the thesis and discussed in relation to the power of assemblages, however, at this stage it is important to unpack the functionality of this machine and the intended (artistic) purpose of its use.

The *LED Transmitter* is a small assemblage of electronic components of which one could say the central component is a 5mm LED, however, this is not the case as we will discover through flattening the ontology of these components in future discourse. This LED is appropriated to perform acts of sonic transmission which are hidden in plain sight (steganography) through the glow of its light. The machine works in a similar way to AM radio where the amplitude of the signal determines the power of its transmission but to look at it it would appear as though there is nothing sonic related happening with the *LED Transmitter* at all. The LED does not flicker in any discernible way perceptible to the human eye but when placed facing a solar cell it is possible to read the fluctuations as voltage changes. When the fluctuations are driven by audio signal then it is possible to hear those fluctuations as recognisable sound or music, depending on the sound source. The machine reflects the early experiments by Alexander Graham Bell with the *photophone* in an effort to listen to sun beams (Kahn, 2013).

The earliest development of the *LED Transmitter* was based on techniques found in *Handmade Electronic Music: The Art of Hardware Hacking* (2009) by Nicolas Collins. In this book there is an early section dedicated to piezo discs and how to build contact microphones and appropriate them in various ways. This seminal text in hardware hacking beautifully links the practices and techniques of how to hack along with key figures in the historical development of this practice from within sound, music, and sonic arts. Especially relevant here are John Cage and David Tudor for their influence on exploring sound with(in) physical devices (for Cage see *Cartridge Music* (1960) and for Tudor see *Rainforest IV* (1968)) that developed an entirely new way of discovering and creating sound. In the chapter *Turn Your Tiny Wall Into a Speaker: Resonating Objects with Piezo Disks, Transformers, Motors and More* (ibid, pp. 44-57) Collins introduces the practice of driving a piezo disc with sound, a reversal of the technique commonly used in sonic arts practices where the piezo disc is used to pick up sound (acting as a contact microphone), here the piezo disc is utilised as an audio speaker putting whatever physical object it is in contact with into a state of physical vibration and thus propagating sound waves. The core component listed in this section is the output transformer which would step the output voltage of an audio signal up in order to drive the piezo disc physically. Having explored the use of piezo discs, as both microphones and speakers, extensively for a number of years and influenced by the experimental approach to everyday objects within Collins' book a variety of different output objects were tried. The use of cheap 3-volt laser pointers (usually found on key chains or as cat toys) as an output device was the first development of audio transmitter for the *transmission+interference* project. The laser pointer was simply soldered in place of

the piezo disc which then required another stage to actually hear anything. Influenced by the tools and sensors involved in the practices of physical computing with Arduino, the laser light (a tiny red dot / line) was aimed at the surface of tiny solar cell used for light sensor projects in physical computing. This solar cell was then wired to a small, cheap audio amplifier kit from the UK based electronics store, Maplin, to enable the sound signal to be heard through speakers. This use of laser light was used as the primary source for sound transmission in the project even though it proved extremely frustrating to aim a tiny red laser dot across a space at an equally tiny solar cell surface - any vibration would shift the alignment of this setup. It enabled various early experiments with sound and light, for example, using mirrors to 'bend' sound around architecture and one of the now central aspects of the project of exploring the space in-between the light transmitter and the solar cell receiver with various objects in order to interfere with the signal.

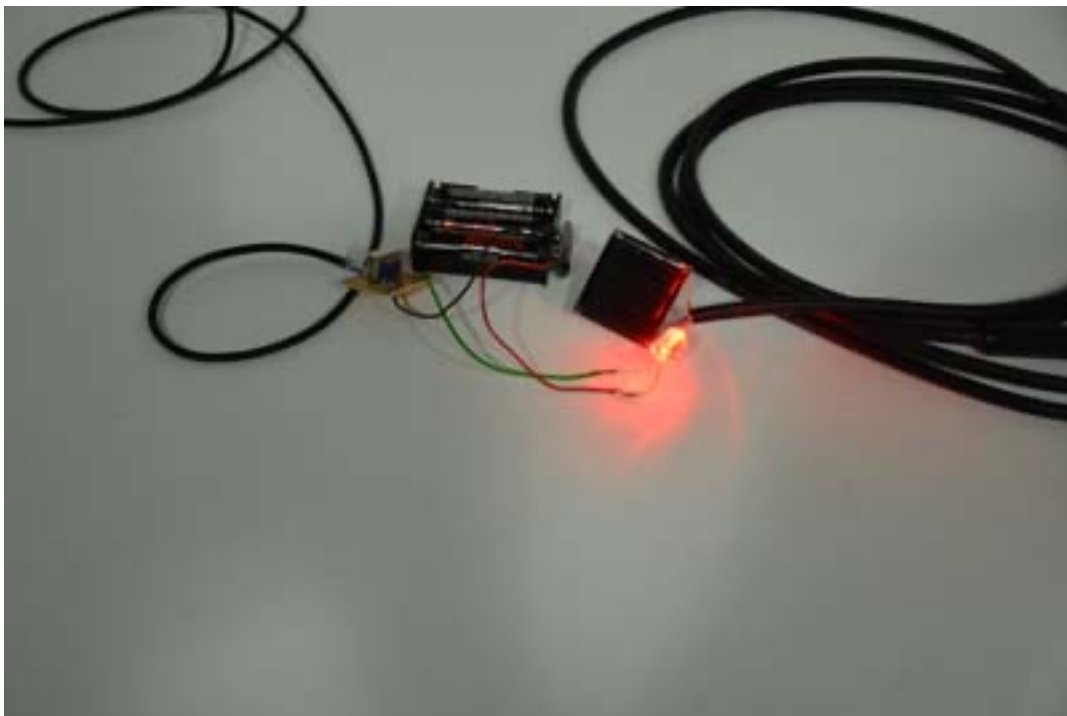

(Fig. 47. Early LED Transmitter)

The use of cheap toy laser pointers yielded one of the most exciting breakthrough moments in *transmission+interference* that has influenced nearly all machines created within the project since. Each of these laser pointers had two light sources, a red laser light and a white LED, and two separate buttons to trigger each of them (simply on / off). In preparation for a *transmission+interference* workshop, where various test machines are built and prepared for demonstrating and sharing in advance, one test was done that accidentally triggered the LED mode on the laser pointer. The device still worked, sound was transmitted but this was much clearer, much louder and had an audibly different quality compared to sound transmitted via laser light. The laser light produces a harsh sound and the attack portion of the sound, when the light first hits the solar cell, is noticeably sharp and brittle to the ear. The sound transmitted via LED, on the other hand, has a far softer and rounded sound and this difference offers new potential - for example, a transmitted sound can now be faded (up or down) according to how much light from the LED falls across the surface of the solar cell. With the laser light the sound would either be on (light hitting the solar cell) or off (no light hitting the surface of the solar cell) but there was no degree of in-between in intensity of sound. This gave the project two unique sounding ways of transmitting sound and the stumbling across (see Pierre Schaeffer in Chapter 3) this new sonic potential occurred through a strong tradition within sonic arts and experimental music - by error. This error (pressing the wrong button on the pointer) fits neatly within the practice of circuit bending, an entire sonic arts practice born out of error and accidents that is attributed to Rheed Ghazala in the late 1960s where he 'encountered the sounds of accidental circuit interaction: an open amplifier left in his desk drawer shorted against some metal

and began whistling.’ (Collins, 2009, p. 106) There is a strong tradition within sonic arts built upon the practice of circuit bending and this accident in *transmission+interference* not only affected the qualities of sound and power of sound transmission but also how open the project would become to experimental electronics hacking practices and embracing of chance and accident throughout not only the making process but also as part of the realised outcomes (installations and performances). This single machine, cracked open to a new potential by accident, then influenced the development of a variety of different sound and light machines using a mixture of LED and laser light. Each machine offered a different way of producing sound, some were focused on simply making rhythm by switching rows of LEDs on / off whilst aimed at solar cells whilst others were focused on pitch produced by moving a laser light, at speed, across the surface of a solar cell.

These initial stages of experimenting and testing with sound and light transmission and reception were influenced by the concept of *Mini FM* by Tetsuo Kogawa (2006) which, in turn, was influenced by Felix Guattari’s concept of *micro politics* and *molecular revolution* (1977). Concepts ranging from broadcast (and narrowcasting) to community to hacking and DIY electronics are all found within the *Micro Radio Manifesto* (2006) by Kogawa and each of these impacted the development of *transmission+interference* even though it shifted into different territories of installation art and performance and away from radio broadcast - as the following thesis will show, the practice of *transmission+interference* shifted to centre on the materials, surfaces and objects utilised in the work. In the manifesto, Kogawa discusses the idea of reducing the power of Mini FM broadcast down from 100

watts to 1 watt, 'such a micro-power radio station could cover only a street block radius or only a housing block complex. Why not?' (Kogawa, 2006).

Transmission+interference can be thought of reducing that broadcast power down to a much smaller scale again, broadcasting, or transmitting, across the length of a table or across the length of a room at most. This finely localised scale of sonic transmission affected not only the types of sound sources used for play but also the community that would be become engaged in the development of *transmission+interference* as a practice.

Community

Whilst much of the early developments of *transmission+interference* seem focused on the technology and sound making machines the influence of various experimental sonic arts practices combined with the emergence of practices in physical computing developed a platform for openly sharing and contributing to *transmission+interference* through the practice of workshops. With the development of open source software and hardware movements since the early 2000s much discourse has developed around the community of those making within contemporary electronic arts and (digital) media arts and this became a focus of the making process for *transmission+interference* from an early stage. Initial workshops were based on the distribution of knowledge from those running the workshops (myself and Vincent van Uffelen) through showing the transmission of sound within light and then sharing detailed, step-by-step instructions for how to build your own *LED Transmitter*. These early workshops developed some interest in *transmission+interference* but it was quickly realised that there were many

limitations to this model of developing a sonic machine (*LED Transmitter*) and then instructing a group of people in how to build it. With this approach the project would not develop beyond this single machine unless we created new machines ourselves to then instruct the building of. Such an approach would then be limited by our knowledge and skills alone. It was clear that to open the making process up to others was the best way of generating new and exciting machines that we would not have thought about and it is through the concept of Hannah Arendt's *natality* (2018), where unexpected results can be achieved through acting collectively, that the power of a community of makers, hackers, artists, designers, musicians, engineers, and beyond begins to broaden the scope of *transmission+interference*.

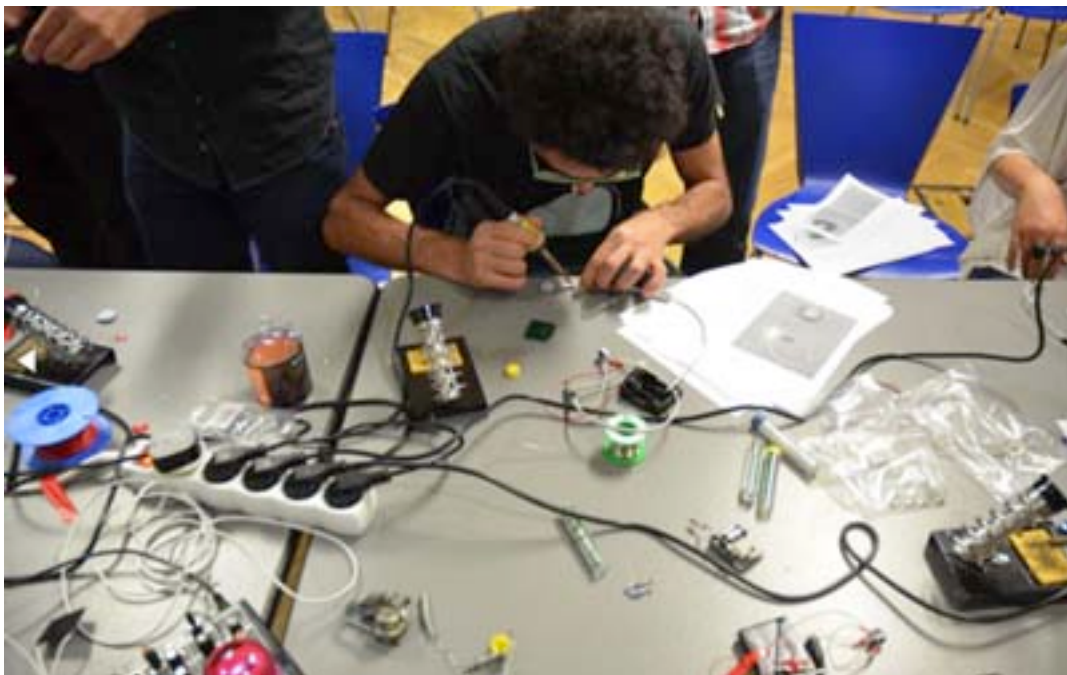

(Fig. 48. Following step-by-step instructions in an early *transmission+interference* workshop @ Di-Egy Fest 0.1, Cairo)

Developing an open style workshop where there is a collective navigation of the unknown around sound, materials and technology is discussed in depth within the

following thesis but it is important to introduce it here as a core part of the making process and, in many ways, as an artistic output in its own right. This shift from an instructional workshop with designated leader (person of knowledge), defined by the Latin term *auctoritas* (Sennett, 2008) where participants learn how to build exactly the same thing, towards an open process where the foundations of *transmission+interference* are introduced as a platform upon which all participants are free to explore and experiment together is not simply a case of just allowing anything to be done. There is a skill in developing open workshops of this type in order to navigate the core themes of *transmission+interference* whilst giving the freedom to build and create without following step-by-step instructions. It is important how participants are selected for workshops through open calls as well as what materials are made available for the duration of the workshop. As more workshops took place it became clear how each workshop follows on from and feeds off the making processes and outputs from previous workshops - essentially developing an assemblage of workshops. Connections would thus form between the workshops, across vast geographical spaces (workshops run in Cairo, Vancouver, Plymouth), with knowledge and skills being shared through disparate groups of people and objects. This concept of sharing skills and knowledge is developed explored further in the opening of Chapter 4 on workshops.

At a sonic level there is an interest in the concept of resonance - how tones and sounds combine and react with each other which is of great importance to the sonic outputs of *transmission+interference* but through the development of this open workshop process it was realised that there should be an interest in the resonance

between participants and each other, between objects and things, and between actual workshops. Most early workshops began by demonstrating the *LED Transmitter* to help frame the following process of making and this quite often became a starting point for many participants where they would quickly build a version for themselves. What used to take a half-day workshop for participants to complete was now taking them much less time, as though skills were being passed directly from workshop to workshop. This resonance between workshops relates to controversial ideas around what Rupert Sheldrake has described as *morphic resonance* (Bardini, 2011) (developed within Chapter 4 on workshops) and the idea, within *transmission+interference*, that the workshops have a form of memory.

Outputs

The final area to cover in framing the practice of *transmission+interference* is to discuss the artistic outputs from the project. This begins with the workshop which acts as its own entity whilst producing, directly and indirectly, machines for performances and installations. The workshops act as an output on their own - a space for discourse, knowledge and skills sharing. For many of the participants at the workshops, that was their full experience of *transmission+interference* and they were able to take new knowledge and skills away to apply in other ways. The workshops act as a practical disseminator of the knowledge in much the same way as a journal paper would be regarded as an output of knowledge and it is of interest that *transmission+interference* began by only running workshops as a method to attempt to work out what could be done with this machine (*LED Transmitter*) that would be creatively interesting. Early attempts at installations were weak as they

served to merely demonstrate the machine and once its process was understood it lacked interest beyond that point. As Paul DeMarinis states 'the real illusions are the ones that still mystify even when the technology is revealed and explained' (Wilson, 2002, p. 399) and the early *transmission+interference* installations held no mystery, operating, instead, as simply a technical show and tell (this quote from DeMarinis is picked up again in Chapter 3.3: Information Noise). For *transmission+interference* to create interesting and thought provoking creative outputs it would need to reach beyond demonstrating a (relatively interesting) technical process. Taking inspiration from a number of artists and musicians, in particular Martin Howse and John Richards, who both actively engage in open workshops (making and sharing collectively) that lead towards a performative output, *transmission+interference* began to develop workshops that would engage in a process of developing sound and light machines for the purposes of performance. These audio performances sit within the field of sonic arts practice at the noisier end of the spectrum - the sounds produced often being very rough as well as the machines themselves being quite rough in terms of production. These performances gave realisation to the importance of noise (see Chapter 3) throughout the project, from sonic output through the speakers into the ears of the audience as well as through the noisy, messy making process. It is performance that enabled *transmission+interference* to become a fully realised creative process that has brought together various strands of discourse gathered here within this thesis (in text and across the practice). Performances were directly related to workshops, with 1 or 2 day workshops run in order to develop machines for a performance following the conclusion of the workshop - giving each performance a unique sonic output due to its geographical

location and the variety of participants. For example, the performance following the workshop at ISEA 2015 in Vancouver, Canada operated differently than a performance resulting from a *Hotwire~* workshop (Plymouth, UK) due to the difference in human and non-human participants taking part. The performances combined the sonic and visual (LED and laser light) components into a much more expressive form than simple demonstration of tools, as mentioned above. The performances discussed within this thesis were largely played out within art gallery contexts, not traditional music performance venues, at intense volumes and in (where possible) complete darkness in order to give as complete an audio / visual experience as possible - the intensity of sound matched only by the intensity of light(s) from the performers. With a natural synchronisation between the lights and the sounds there is an obvious connection to the field of synesthesia and this particular concept was explored in the installation *Transmission+Interference: Digital Synesthesia* (2016) as part of the *Digital Synesthesia* exhibition curated by the University of Applied Arts, Vienna (2016). The exhibition is discussed throughout the thesis as it is a useful point of discourse around various themes including information theory, noise, and interactivity. It is these themes that are of central concern in the thesis and not synesthesia. Synesthesia, in particular that of sound and color crossover, has a very popular and long history within music and the arts but has never been of main interest in *transmission+interference* and it is not here where the project aims to offer any new insight. The installation has a very direct connection to Shannon and Weaver's Mathematical Theory of Communication (1948) and the interference of noise in signal transmission and, therefore, it offers a different application of noise to that explored within sonic arts performances of

transmission+interference. The various outputs of workshop, performance, and installation combine to provide an overview of the main themes of this thesis: noise, making, and the importance of objects.

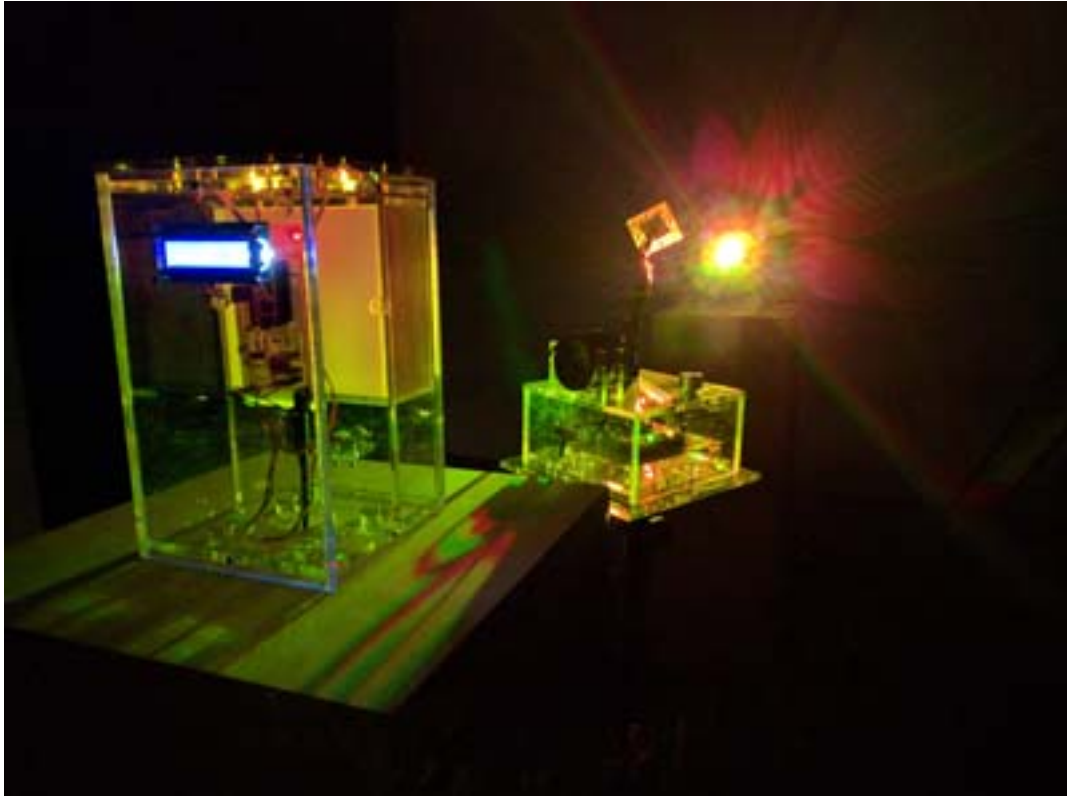

(Fig. 49. Transmission+Interference: Digital Synesthesia)

Chapter 2: Objects

2.1 Introduction

Keywords: Vital Materialism, Assemblages, Objects, Machines, Noise

The aim of this chapter is to explore the objects and materials in installation and performance artworks from across the interdisciplinary fields of media arts, digital arts and contemporary technological arts and is positioned at the noisier end of the artistic spectrum of these disciplines. The aim is to unfold an understanding of the creative potential within the movement and flow of noise in machines or systems utilising light and sound. Central to this aim is the discussion around the physical (and non-physical) objects at play within tools / devices / technological machines in order to realise the power in the non-human object and its extended interactions. This is not meant as a means to ignore the human, following from Barad's quote in the Methodology section, but rather as a case to present a more entangled discourse of human, object and machine where the influence of minuscule particles over actions and activities of a machine are viewed as equally important as the hand, flesh and brain that engages with them for artistic purposes. This particular approach engages fields of theoretical discourse recently emerging from posthumanism known as Object-Oriented Ontology and New Materialism. This theoretical discourse brings together fields of resonance, difference or in-between, interference, interaction, intra-action, and feelings. To deal with the creative complexity of this research-as-practice, a variety of practical projects will be discussed including works by Robert Henke, Jim Frize, and Martin Howse along with *transmission+interference* (Strang and Van Uffelen, 2008-2023) and *Light Entropy* (Strang, 2014).

The *transmission+interference* project is central to the practice element of this research as detailed earlier in the *Practice: Transmitting, Receiving, and Interfering* section of this thesis. As many of the machines constructed within the practice are for the production of patterns of sound and light they suggest the term ‘instrument’ but that carries too much of a classical connotation of standard musical practice or too scientific. This chapter begins by exploring the appropriate terms to use in relation to the practice through a discourse mixing object-oriented ontology and machine-oriented ontology that presents a non-anthropocentric view of all the materials involved in its development. This is a necessary task at this stage of the thesis so as to introduce the core elements of the practice along with certain artistic influences and allow for a discourse that supports both the materiality and the immaterial. The text also encourages thought around the adaptability and potential for appropriation of all the materials that are connected to a messy, noisy making practice that is involved in the creation of machines that contain degrees of imperfections. Once the terms regarding these materials have been introduced the thesis moves onto explore the concept of life within the materials as a vital materialism that engages further with new materialism in relation to object and machine-oriented ontology. Within this section the potential powers within the material and immaterial things of the practice is raised to develop an understanding of how they operate. This leads into the final section of the chapter where this vitality of materials is explored through the concept of assemblages, in particular vital assemblages, aiming to understand the collective powers and potential

contained within the practice. This results in an introduction to one of the core materials within the research: dust.

2.2 Objects & Machines

Keywords: Objects, Machines, Relations, Lists, Ontography

Objects are operating all across the practice of *transmission+interference*. They are the key components to any of the making that takes place in workshops (Chapter 4) and are the creators and conduits of noise (Chapter 3) through being both interference and the sonic output within performances and installations. To begin this thesis it is, therefore, important to unpack what the objects of *transmission+interference* are and how they operate when collectively assembled to perform. This initial discourse follows lines of thought from Object-Oriented Ontology (OOO) through Bogost, Harman, and Bryant as well as Bryant's term of *onticology* (2011) to develop an understanding of objects within *transmission+interference*. The initial aim here is to tackle the terms to arrive at what works best for the practice of *transmission+interference*. What are the objects of *transmission+interference*? Are they things, materials, bodies, devices, tools, or something else? Ian Bogost (2012) and Levi Bryant (2011) both present cases in response to Graham Harman's initial outlaying of the term *object* from within OOO, that explore this terminology and why it matters to work with the appropriate terms so as to avoid issues that may become difficult to untangle when, for example, faced with the dichotomy of anthropocentric / non-anthropocentric views. Operating from within the same school of philosophy that directly emerges from Kant and his development of the *thing-in-itself* (Kant, 2003) it becomes clear that each respective development of the term *object* is in slight disagreement with the others. Bryant, in his development of *onticology*, remains in agreement with Harman

about the use of the term *object* but his future position on this changes as will be revealed when *machines* enter the discourse. *Object* acts as a useful term for his initial attempts at presenting a flat ontology, 'there is only one type of being: objects' (2011, p. 20). At the centre of his claim is the post-humanist positioning of the human and the non-human - to use the term *object* decenters the human from the discourse, humans are objects just as a table or a frog or a lump of metal is but there is a problem of shifting into a world of objects (material, non-human) that are overcoding¹ (Deleuze and Guattari, 1983) the human and *onticology* takes care to ensure this should not happen - the aim is always for a flattening between the human and non-human. A *flat ontology* (OOO or onticology) operates in opposition to traditional philosophy as it does not see a split between human thought and all other things, instead all are treated equally as objects. Traditional modern philosophy still positions any discourse of the world around the human whereas a flat ontology avoids, what Quentin Meillassoux has termed, *correlationism* (2015) where it is only possible to speak of a world with humans (Harman, 2018). Bryant handles the most obvious other issue of the term *object* by dealing with the object / subject split (or nature / culture as he refers to) and making efforts to avoid an

1. The concept of *overcoding* from Deleuze and Guattari, established in *Anti-Oedipus* (1983), relates to a single object with territorializing power over all other objects without the possibility of affect feeding back. 'Overcoding is the operation that constitutes the essence of the State, and that measures both its continuity and its break with the previous formations: the dread of flows of desire that would resist coding, but also the establishment of new inscription that overcodes, and that makes desire into the property of the sovereign.' (1983, p. 198)

object as merely a representation for the subject through its framing and is careful to ensure that this is not simply an operation of inversion but is where subjects become objects that exist amongst other objects (2011). 'In shifting from a dual ontology based on the nature / culture split to collectives, onticology, and object-oriented philosophy place all entities on equal ontological footing.' (2011, p. 24). In fact, this ontological flattening and concept of *equality* is the shared aim across all OOO authors (objects) and is a good place to bring in Ian Bogost and his concept of *Alien Phenomenology* (2012), also developed by Bryant, which aims for a true decentering of the human, seeking to investigate the world through non-human methodologies of ontography, metamorphism, and carpentry, that is open to the ways objects operate in and perceive the world. One of Bogost's central claims here, also agreed upon across OOO authors, is:

'[A]ll things equally exist, yet they do not exist equally.' (Bogost, 2012, p. 11)

This phrase, that Bryant too references a number of times in his writing, brings under control the issue in flat ontology that through stating that 'all beings are objects' it is therefore concluded that there is no hierarchical power between objects. In *transmission+interference* there is no such object that is able to affect all other objects whilst at the same time not being affected in anyway by any other object - there is no vertical ontology,² but there are some objects that are able to exercise greater control and power over others. There is no God like object of *transmission+interference* - each object is open to be affected by any other (Bryant, 2014) but this does not necessarily mean that it can and will be affected. Bogost

2. The opposite of a flat ontology that instead operates from positions of hierarchy and overcoding.

presents a case for his term in place of *object* - *unit operators*, through arguing against *object* and *thing* as materiality only and that it exists only for the human. He claims that OOO is not able to move away from the subject (and this would be the human subject) implied by the use of *object* no matter how hard it tries and the only way to ensure this happens is to avoid using the term *object* (Bogost, 2012). His concern that the term '*object* implies materiality' (ibid, p. 23) is not too well structured but remains one of the key misunderstandings about OOO, that it is largely a philosophy based on materialism, which it is not and Harman makes efforts to avoid this simplistic connection between an object and physical stuff (Harman, 2018). *Thing* is not a solution for Bogost either as it is rooted too heavily within philosophy as a *thing-for-humans* following from Kant and then Heidegger who uses the term directly as something that is human created (Bogost, 2012). Neither of these terms, for Bogost, manage to escape the physical materiality of an object to be able to deal with the relations between objects either, however, to follow Bryant's 'only one type of being' then relations between objects are objects themselves. Bogost borrows from chemical engineering and systems theory to coin the term *unit operators* that does present a possible new phrase, however, for *transmission+interference unit* is too related to computer science - the project engages in certain computer processing (coding for Arduino, writing patches in Pure Data and Max) but it largely operates outside the computer with physical objects. A second issue with the use of *unit* within *transmission+interference*, that Bogost claims as its greatest strength, is how isolated and specific the term is. This works well for a cleaner, systematic space of operating such as computer science but, as will be encountered throughout this thesis, the term is required to deal with a

messier, fleshy assemblage of objects. *Operators* though is a useful term borrowed from systems theory where ‘an operation is “a basic process that takes one or more inputs and performs a transformation on it.”’ (Bogost, 2012, p. 25)

Transmission+interference requires the presence of some materiality that the term *object* offers but through OOO we are constantly reminded that this is a term for all - for humans, non-humans, and the relations between. The biggest challenge in this discourse is to decentralise the human and Roy Bhasker presents a good reminder that the human is not central to creativity, nor is it even required to exist for certain objects (here he talks of *objects of knowledge*) to continue operating as they do:

‘the specific gravity of mercury, the process of electrolysis, the mechanism of light propagation. None of these ‘objects of knowledge’ depend on human activity. If men ceased to exist sound would continue to travel and heavy bodies fall to earth in exactly the same way.’ (Bhaskar in Bryant, 2011, p. 41)

This phrase neatly removes the human from the centre whilst presenting non-material objects that continue to operate. This thesis will continue to use the terms *object* and *operate* but not only those terms. Firstly, much of the literature involved in this discourse uses different terms - Bogost’s *unit*, Lucretius’ *thing*, Bennett’s *bodies*, or Haraway’s *critters*, for example, but these are all flattened to *objects* for this thesis and within the practice of *transmission+interference*. Secondly, Bryant develops his OOO positioning through his text *Onto-Cartography: An Ontology of Machines and Media* (2014) to arrive at a *Machine-Oriented Ontology* (MOO) that introduces the *machine* and all of its operations to the discourse. This links Bryant to Deleuze and Guattari through their use of various machines (for example, desiring

machines, abstract machines, and machines of war). From an anthropocentric viewpoint the *machine* would usually appear as something designed by humans, however, Bryant follows DeLanda's use of the term *emergence* to claim that, for example, the machine of a tree is not something designed by someone but instead emerges 'from out of other machines without any intentionality guiding this emergence.' (Bryant, 2014, p. 18) The term *machine* fits perfectly well within the practice of *transmission+interference* where various objects are assembled to operate together to produce sound and light - these assemblages of objects will be called *machines*. As will be encountered throughout the discourse of this thesis, the concept of emergence around the development of these machines is useful to understand too as *transmission+interference* is a machine that does not operate as a single entity but captures the emergence of objects and equally expresses emergent properties through new sounds, making, and machines. The term *machine* also enables the discourse to develop beyond the material objects and also capture the relations between the physical objects as this will become increasingly more important. Those spaces, gaps, or voids that are the in-between have long been of importance in the philosophy around materiality and objects. For Alfred North Whitehead would go as far to state that an entity is 'nothing more than its relations' (Harman, 2018, p. 49) and even the great materialist poet-philosopher Lucretius would begin his greatest work *De Rerum Natura (The Nature of Things)* through a discourse around matter and void to claim that the void is equally a thing in existence:

'So that which is of lighter weight but seems the same in size
Reveals without a doubt it has more void within. Likewise,
An object of the same size that is heavier, must contain

More matter in it and much less of emptiness, it's plain.
Clearly, therefore, what we're tracking with keen-scented wits -
What we call void - is tangled up in things, and must exist!³
(Lucretius, 2007, p. 14)

The poetry of Lucretius serves as a very useful early treatise on objects and materials and offers many starting points for OOO and MOO and what will follow around New Materialism. Lucretius manages to position materiality, things, and voids within what Timothy Morton would describe as a *mesh*, that is a good entry point for the later discourse around vitalism and assemblages.

Transmission+interference is best discussed as a collective assemblage³ of objects and machines that operate upon themselves and within each other. *Machine* could almost be the sole term to handle all of the objects in *transmission+interference* but even Bryant is unable to complete his thesis on MOO without resorting to the use of the term *object* on many occasions. This section will now continue to understand the different types of objects that operate before ending on the topic of ontography and one of OOO's most common traits: lists of objects.

Through his onto-cartographic discourse on gravity, Levi Bryant introduces a very useful list of six different type of objects that exist that Harman neatly updates to describe as six different roles that any object can fill (2018). These six types initially introduced as 'six types of gravitational relations a machine can occupy within an

3. The collective assemblage is understood here in development from Deleuze and Guattari's multiplicities. The collective is a multiplicity that extends beyond the individual as part of the social. (Guattari, 1995)

assemblage, ecology, world, or society.’ (Bryant, 2014, p. 198) are of most use when exploring how objects and machines operate in complex assemblages but for now they will be introduced as terms to be picked up later. Essentially, these types of object roles can be explained through their differing impact upon other objects they encounter and this can range from having absolutely no impact to having chaotic, random impact upon others. The reason why Harman’s intervention with the term *roles* is important is that no object is fixed to only operate as one type but instead that type can shift according to the assemblage within which it operates. This is useful to consider within this thesis as objects appear and operate in different ways throughout according to various factors - users, location, cost, artistic context. Within *transmission+interference*, a tiny vibration motor can operate in a machine in a highly influential manner to the creation of sound and can equally withdraw into the background operations of other machines. The object types are: dark, bright, satellites, dim, rogue, or black holes. (ibid, 2014). Across this list from brightest to darkest is the shift from objects with the most influence to those with the least, with one object type, black holes, paradoxically operating brighter than the brightest object as absolutely nothing can escape the influence of such an object. Such an object in *transmission+interference* would be dust and noise that, even in their most withdrawn states still has great influence over operations of other objects. Dust will begin to be explored towards the end of this chapter and noise will be fully encountered in Chapter 3, along with dust again. A dark object is one that, to use Harman’s terminology from OOO, is so withdrawn to the point that its influence is completely non-apparent. It could be questioned whether these even exist, since there would be no way of knowing but Bryant includes the

distinguishing factors of absolute and relative. A relative dark object is one that perhaps is not of influence in one assemblage but becomes so in another - Bryant uses the example of ultraviolet light as a relative dark object, unseen by humans but visible in assemblages of other objects. Bright objects have the biggest influence upon objects in the assemblage, in fact, upon all objects - they overcode the behaviours of everything else, just how Negarestani (2008) points out the sun overcodes all life on earth. Satellite objects are those that are caught in the orbit of bright objects - those that are open to influence from the bright objects and therefore operate according to those relations. Dim objects are the least bright of all the types and exercise very little influence over any objects. Finally, rogue objects are those that appear out of nowhere and appear to be very separate from all other objects in the assemblage. Instead of linking into already formed networks or operational structures the rogue object acts to 'reconfigure gravitational relations between entities within the world in which they appear.' (Bryant, 2014, p. 209) These are the most exciting of objects along with relative dark objects within *transmission+interference* as '[n]o one can anticipate when or where they'll appear, but they suddenly erupt into worlds, transforming relations between machines that compose an assemblage.' (Bryant, 2014, p. 208) Bryant's use of 'no one' in this sentence is slightly problematic given his great efforts to flatten the human / non-human relationship and reduce the hierarchical power of humans. Surely it would be better to use the term 'nothing'. Rogue objects are an encounter with the first form of noise, that appear to wander in space and time, within the thesis and one of the most important terms from Lucretius' poem - *clinamen* that will be unpacked in the following section on vital assemblages.

The final point to raise in this section is in regards to the use of lists within the writing of OOO and the practice of ontography. This may appear as a method for simply displaying, for example, all of the objects operating within a given assemblage and can often result in long trails of objects in an effort to capture the scale of all the objects as well as the diversity that exists between any human and non-human objects. A list might contain a country or a planet as well as an insect or neutrino and can lead to quite humorous inclusions due to odd juxtapositions. Here is an attempted list of objects in *transmission+interference*:

LED, DC vibration motor, nails, wood, IKEA, polarity, electromagnetism, solar cells, copper, plastic, potentiometers, Arduino, the internet, Sweden, humans, resistors, capacitors, shipping, postal services, dust, schematics, coding languages, rubber, mirrors, media players, sound waves, lasers, speakers, magnets, DC motors, ...

Lists are useful in some ways to quickly and simply detail the complexity of an assemblage of objects and, something which is of central importance to Ian Bogost, they enable a way to capture each object's (or unit's for Bogost) uniqueness and individuality. 'The inherent partition between things is a premise of OOO, and lists help underscore those separations' (Bogost, 2012, p. 40). He is keen to emphasise the utter isolation of each object through the use of lists in a move that places him against one of the key influences over *transmission+interference* - Deleuze and Guattari and collective becomings. The list is neat and clean and offers no discourse around the relations of those objects included - this is a problem for

transmission+interference but surely also one for OOO and Bogost who claims that OOO should be messy (ibid). This thesis on *transmission+interference* will be dealing with objects *and* their relations, and noise and chaos not cleanliness and order so lists feel redundant. A development from the list in OOO is the use of ontography which, according to Harman is ‘a name [...] for the exercise of describing and classifying pairings of objects.’ (2011, p. 124) and one the best methods of this is the exploded view diagram (Fig. 50).

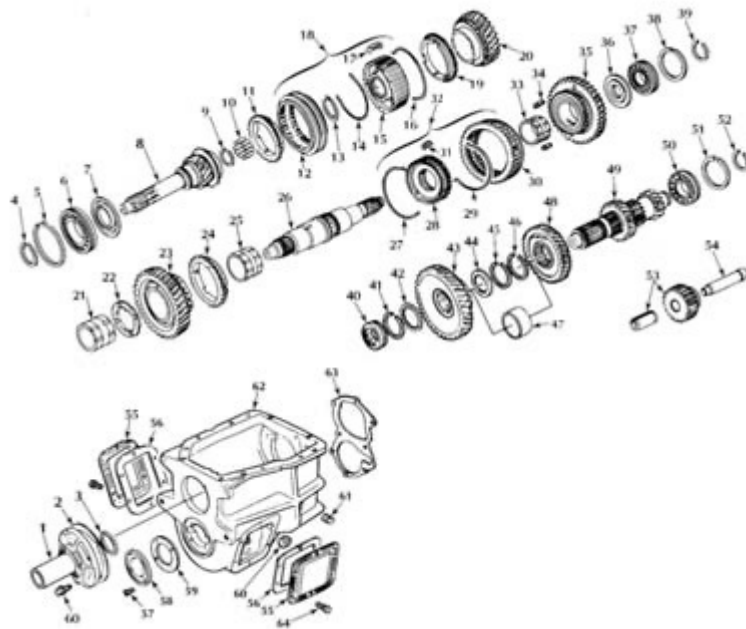

(Fig. 50. An exploded view of Shimano bike gears showing the immediate neighbour connections.)

Far better than a list of words, the exploded view manages to detail the couplings and relations of objects in a manner that conveys the complexity of the machine that emerges once the assemblage is achieved. However, as shall be developed and then shown in the final section of Chapter 3: Workshops this type of image fails to truly handle the noisy complexity of *transmission+interference* in all of its

Deleuzian becomings where objects are not cleanly laid out in a fashion that explicitly details how things should fit together. *Transmission+interference* embraces disordered mess of chance encounters between objects instead of the smoothness of lists.

To build upon Francis Spufford cited by Bogost (2012, p. 40):

“Lists refuse the connecting powers of language” and ontography refuses the entangling powers of noisy making. The thesis will now engage with these powers.

2.3 Vital Materials

Keywords: Vital Materialism, Relations, Power, Substance, Resonance

To continue the thread of the flattening ontology between humans and non-humans (between all objects) this section explores the concept of life in materials, a vitalism in objects and will continue to draw from OOO whilst introducing thought from within New Materialism that offers a more fleshy, active, expressive world of objects that resonates with the materialist thinking of Deleuze and Guattari far greater than OOO does. In Jane Bennett's essay 'Systems and Things' (2015) she situates vital materialism more closely within the naturalist or Romantic realm (Bennett, 2015) through using the term *thing* or *body* - closely linking Bennett with the bodily affects coming from Spinoza (1996). However, as discussed above, this thesis aims for a less anthropocentric approach than Bennett suggests through the use of *object*. By removing the terms *body* and *bodies* when discussing human actants within a process, the level of discourse is flattened to acknowledge the influence of, for example, a 10k resistor (Fig. 51) just as much as a human workshop participant. This section in the thesis is where, particularly non-human, objects and machines and their relations begin to stand up and reflect back upon the user (Sennett, 2008). As Jane Bennett states by introducing the term *thing power* that 'draws attention to an efficacy of objects in excess of human meanings, designs, or purposes they express or serve' (Bennett, 2010a, p. 20), the object has a power and desire of its own before human interaction - this is the object's vitality. However, before diving into vital materialism there are certain aspects of objects and machines that should

be setup in order to eventually develop a greater understanding and how it vitally affects the thinking of *transmission+interference*.

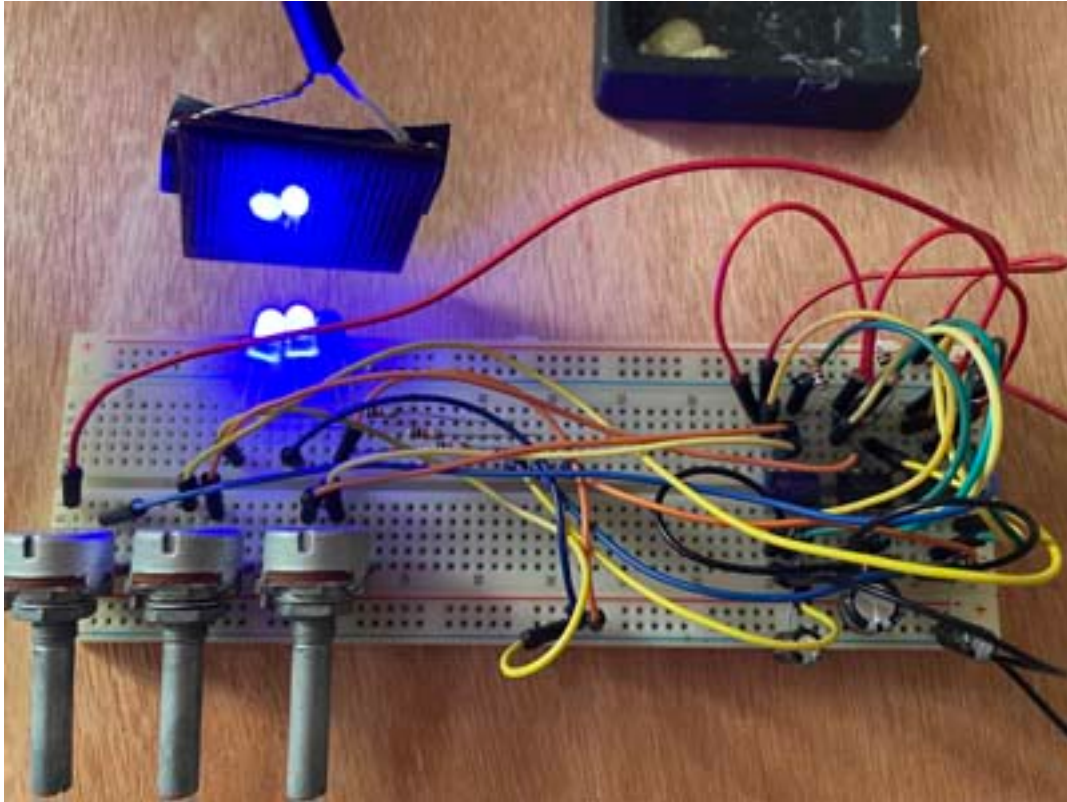

(Fig. 51. LED DrumMachine: this version on a breadboard allows for live hacking of the 555 timer circuit. Changing the resistors physically during playing will alter the range of blinking frequency in the LED output)

The *power* of all objects is central to the creative performance of *transmission+interference*. This is how an object does what it does, or acts, and how ideas, skills, workshops, performances, and installations are able to emerge. According to Bryant this power resides within the objects and within the relations between objects which he refers to respectively as *endo-relations* and *exo-relations* (2011). This follows the OOO position that objects cannot be reduced to simply their relations (Harman, 2018) whilst highlighting that relations *between* objects is a site for generative activity that, within the arts and sciences, is particularly lively and

worthy of critical and creative investigation. Through relating to an object, certain powers of that object can be expressed but not all of its powers at once, it then depends upon the type of relation and the other object(s) in that relation. This results in the concept that objects have *hidden powers* that through various relations can be expressed but it is not possible to experience all those powers together, the object holds certain powers back and only releases specific powers upon engaging in a connection with another object. A common example is used by Bryant when he discusses the formation of H₂O from one object of oxygen and 2 objects of hydrogen. Here, the machine of water emerges from this coupling that expresses a whole new set of powers that are not present locally (endo-relations) within separate hydrogen or oxygen objects. For example, oxygen and hydrogen would react very differently to fire than when they form the machine of water. (2014)

A good example of this in relation to the objects and light sensitive operations of *transmission+interference* is in the machinic creations of Nyle Steiner, in particular, his *Homemade Photocell* from 2003 which brings together very few objects to make light sensitive material. Prior to their connections they are not sensitive to light at all for the purposes of generating voltage or sound. By collectively assembling a sheet of copper in contact with a piece of copper wire with only a water and salt solution bridging the gap it is possible to reveal voltage jumps from the point on the surface where they all contact. Each piece of copper (the sheet and the wire) and the salt solution individually have their powers or agency of their own but once they form this particular assemblage new potential is realised and begins to emerge from the machine. This is something Jane Bennett identifies as the agency of assemblage: 'each member and proto-member of the assemblage has a certain vital force, but

there is also an effectivity proper to the grouping as such: an agency of assemblage.’ (Bennett, 2010a) This ‘agency of assemblage’ (which will be returned to in the next section of this chapter) is apparent when low frequencies emerge from the Elastic Band Drone Machine, each object contributing to a new potential that would be unrealised if not combined in such a way. As Bryant states ‘objects are always in excess of any of their local manifestations, harbouring hidden volcanic powers’ (2011, p. 70). The *local manifestations* mentioned here are the endo-relations and the term of *excess* will be returned to throughout this thesis, especially when discussing noise. There are *hidden volcanic powers* erupting constantly throughout *transmission+interference* where objects and machines combine and new powers emerge that are expressed in sound, light, and rhythm. In the machine *Circle Draw* (Fig. 52), mirror, motor, laser light, solar cell, and the human eye are brought into connection to express the movement of light - a new machine that expresses audio frequency emerges but if this assemblage of objects were reconfigured in some way, for example, using the motor without a mirror but instead something that cyclically blocked the continuous flow of laser light then a rhythm machine would emerge. This reveals important aspects of the making processes within *transmission+interference* that will be unpacked further in Chapter 4 on workshops.

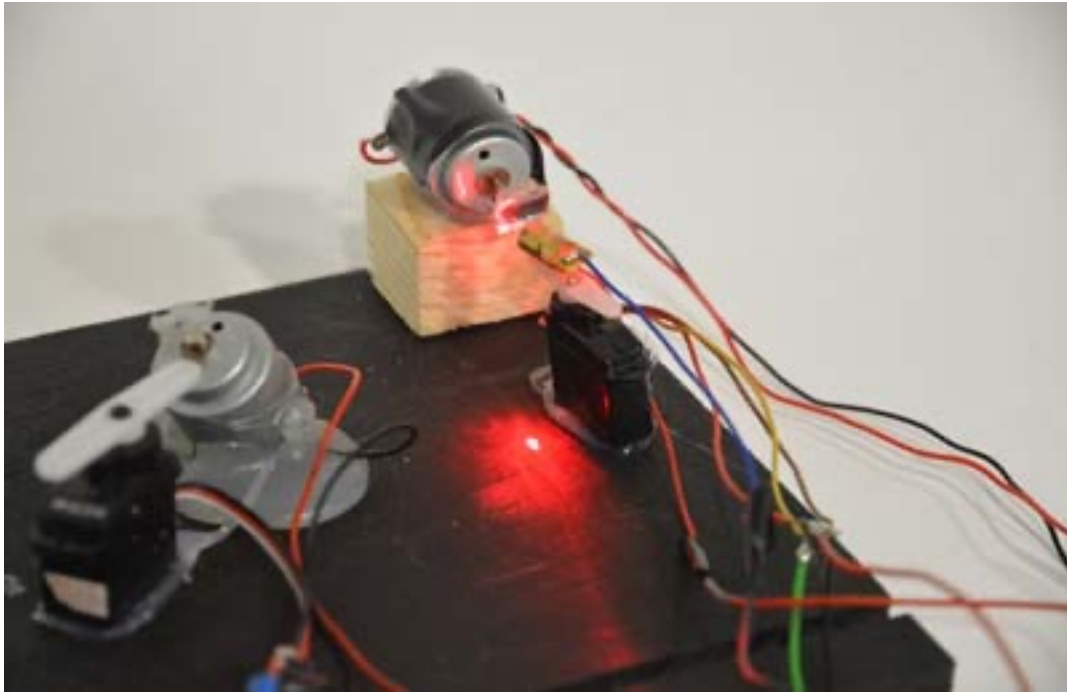

(Fig. 52. Circle Draw machine. A small mirror spinning off axis on a DC motor draws out lines of red laser light that are shone upon its surface. When this circle of light crosses a solar cell a sound frequency is produced determined by the speed of the motor.)

Now that objects and machines contain certain *powers* that are differentially expressed according to the relations they engage in it is useful to understand that this term, *power*, is determined from Spinoza's *Ethics* and the concept of *potentia* (1996) which relates to discourse on substances, power, and affect that are influential over the thinking of vital materialism - how materials become lively and how that is expressed. In following this philosophical underpinning of materialism from Spinoza's metaphysics this thesis is thus able to identify the unifying concept of *substance* that again helps to shift the discourse of objects away from only being about material things and also brings in one of the running threads of this thesis - resonance. All the objects, machines, concepts, relations, interactions etc that are the making of *transmission+interference* are substances irrespective of scale as Spinoza expressed that '[a]ll things exist and are conceived through

substance' (Grosz, 2017, p. 59). *Transmission+interference* is a substance, a capacitor is a substance, a sound wave is a substance, the concept of vibration is a substance, Arduino code is a substance and on and on. Grosz continues to develop a discourse around substance that explores beyond the individual object arguing that all objects that make up a substance are substances of their own too and when combined increase that overall substance's potential to act (2017). This discourse resonates with the *relations* and *hidden powers* of Bryant by allowing for a realisation of a substance made up from other parts and their relations as Grosz states, '[s]ubstance is the whole that contains and magnifies its "parts" by enabling them to resonate with each other.' (2017, p. 61) but she continues to add that this relates not only material things in a way that is better expressed than Bryant's efforts, '[s]ubstance is both material and incorporeal, both objects and ideas (and more), the whole within which both things and ideas exist.' (ibid)

Vital materialism emerges through discourse of materials, objects, the non-human, and initially at the level of cellular biology to explore life in matter. Two particular terms are dominant in the initial outlaying of vital materialism: *entelechy* (Driesch) and *elan vital* (Bergson). Through research materials that explore these terms the most dominant is that of entelechy coming from Hans Driesch and picked up by vital materialists such as Jane Bennett, Karen Barad, and Elizabeth Grosz. Driesch developed the term from Aristotle in regards to an organism's self-movement and power to alter itself (Bennett, 2010b) setting up concepts relating to Spinozan modes of becoming whilst invoking thoughts around inorganic machines. Entelechy re-connects matter to ideas of power and potentiality (Spinoza) in regards to its

ability to direct its power(s), to develop flows of potential becoming but Driesch limited his discourse, as pointed out by Bakhtin, ‘with an image of machine as a “totally prefabricated” and “fixed and immovable” assemblage.’ (Bennett, 2010b, p. 56) Both Bergson and Driesch had developed their concepts to introduce vitality into the discourse of matter - it was no longer dead or inanimate, objects (bodies) were capable of *doing* things *with* other objects (bodies). A vibratory resonance was established between objects in regards to how they make their worlds. Objects chaotically distributed across a workshop surface are in resonance with each other through their respective powers, they have a vitality to direct certain powers for new machines to emerge from within. Vital materialism continues this thread of life in matter through Deleuze and Guattari’s concepts of expressive matter, particularly arising from their discourse on metallurgy⁴ from *A Thousand Plateaus* (1987). What this enables is that matter does not require a separate life force (such as is entelechy or *elan vital*) for it is a life itself ‘a vibratory effluence that persists before and after any arrangement in space’ (Bennett, 2010a, p. 57).

‘In this strange, *vital* materialism, there is no point of pure stillness, no indivisible atom that is not itself aquiver with virtual force.’ (ibid, p. 57)

4. In their discourse on nomadology, Deleuze and Guattari explore the practice of metallurgy as an opposition to the hylomorphic model of making. The hylomorphic model follows that form and structure are imposed externally upon matter to create new forms. However, through metallurgy, Deleuze and Guattari suggest, themselves following Simondon, that (expressive) matter can instead be followed.

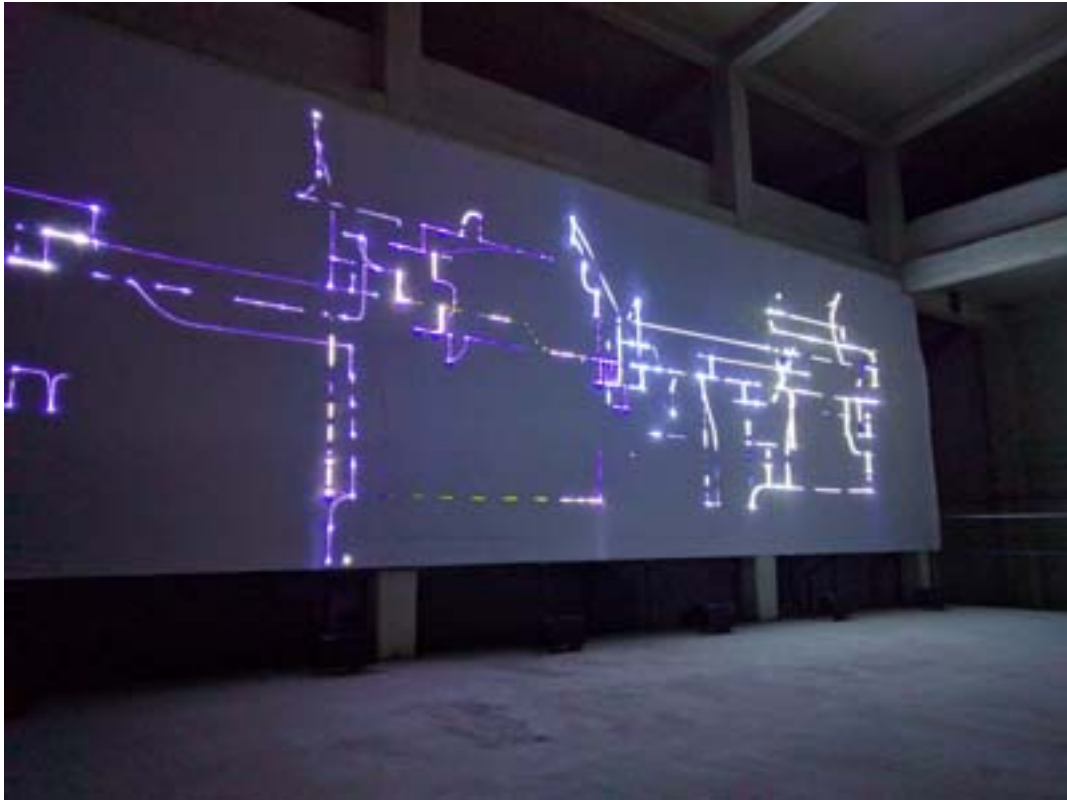

(Fig. 53. Installation view of *Fragile Territories* (2016) by Robert Henke. Exhibited at Loop Conference, Berlin, 2016)

This vitality is present in the work *Fragile Territories* (2016) (Fig. 53) by Robert Henke that itself resonates with text written by Jane Bennett (2010a) about the electricity blackout that occurred along the Eastern Seaboard of North America in 2003. In order to detail these works the influence of the in-between and its resonating potential shall be briefly introduced - both are important in a world of vital materials. At the most basic level, an object in action within a machine swings back and forth between state 'A' and 'B'. A string on a musical instrument or a square wave shifts between these states, resonating the difference. For resonance to occur there must be at least these two possible states and between them they produce the in-between - the space for resonance to occur. The space between is where the sound comes from with the plucked string as it vibrates between one position and the

opposite. As Brian Massumi states '[a]n echo, for example, cannot occur without a distance between surfaces for the sounds to bounce from. But the resonance is not on the walls. It is the emptiness between them.' (Massumi, 2002, p.14). It is maybe less clear, initially, that the square wave operates in much the same way as it is formed of just the two states: '1' and '0'. However, it is now possible to peek inside these two states and realise a whole new field of numbers - 'Mathematicians call this new rigor "fuzzy": fuzzy subsets, fuzzy topology.' (Serres, 1980, p. 57) Fuzzy Logic explains how there is no longer simply a "yes" or "no", a "1" or "0" - at the point of change in a square wave there is a slope to begin the difference between the states. With space now between them it is then possible to experience vibratory fields of resonance. This difference between states and expression of the analog within the digital is explored in Henke's installation work *Fragile Territories*. The installation is a complex setup of multiple laser points drawing across the large, flat surface of a building in tight synchronicity with sound. It demonstrates a level of precision achievable with digital tools operating under strict guidelines of code but the operations Henke is exploring with the tools are not necessarily the standard operations. It becomes clear that the square waves and straight lines that are standard output for a system like this are not all he is interested in. The difference in-between points begins to appear on the surface of the wall - curved lines only made apparent through not turning the laser point off (as it should be) as it moves from one space to another, writing hundreds of different points of light per second at a speed so absolute (Deleuze and Guattari, 1987) that the viewer experiences light after it is drawn and the pointer has already moved away to draw multiple other points. The viewer only experiences the in-between state of light burnt onto the

retina (a persistence of vision) but it is not only this difference that the installation makes so vivid. Every so often a laser point would begin drawing lines outside of the set screen space and would appear to be making explorations of the architectural space beyond the sets of code controlling it. This would happen at random times and not always in the same area of the installation space suggesting a certain vitality existing within the light, the code and the machine. Jane Bennett writes about the blackout that occurred along the Eastern Seaboard of North America in 2003 to explain the concept of agency within assemblages of objects. Assemblages will be explored in the following section of this chapter but Bennett's text helps to demonstrate how likely material agency is to produce unexpected results even within such highly monitored and controlled environments as the power plants serving the electrical grid of North America. The electrons in Bennett's text and the laser light in Henke's installation are affected here by what Bennett refers to, through a phrase borrowed from Bruno Latour, as a 'slight surprise of action' (Bennett, 2010a, p. 27) or Bryant's *rogue objects*.

'Electricity, or the stream of vital materialities called electrons, is always on the move, always going somewhere, though where this will be is not entirely predictable. Electricity sometimes goes where we send it, and sometimes it chooses its path on the spot.' (Bennett, 2010a, p. 28)

Upon viewing Henke's installation, the vibrancy of the blue laser light mapping out a grid-like structure appears to be directly connected to the text from Bennett. Especially the idea of an electrical signal (or vibrant electrical laser light) choosing a

different way of operating than following sets of instructions. The laser light and the electrons are nomadically wandering within their *umwelt* (Uexküll, 2010). Uexküll's term *umwelt* is frequently used by authors influencing this research (Deleuze, Bryant, Bennett) as it enables a discourse about environment which is relating to an object's experience of its own environment and not the human experience of that object and its environment. The term was developed around a discourse of animal and humans but finds a suitable home within the posthumanist philosophies of this thesis (OOO, MOO, and new materialism) due to its decentering of human experience. The vitality within Henke's laser light flying off the written path to explore other architectural folds and surfaces gives the work such life, such vitality and when coupled with the experience of the difference between laser light points begins to demonstrate an exciting level of interaction occurring within machines - something that Andrew Pickering would describe as the 'dance of agency'⁵ (Pickering, 1995). At the point where *Fragile Territories* is installed and ready to be experienced by the public it moves beyond the controls of Henke's code and he experiences a passive role whilst watching his work begin to take on a *life* of its own - in this artistic context it appears that this was actually enjoyed by the artist,

5. Coming from Pickering's text *The Mangle of Practice* (1995) this term denotes a playful back-and-forth approach between scientists and a new machinic construction where the human figure takes on a passive role as the machine demonstrates its materialist agency. Whilst this term is useful for handling the shifting of agency that can occur between, for example, an artist and their installation it is grounded in an anthropocentric view point that should be now be understood, following OOO, MOO, and new materialism, as the dance of agency amongst all objects and machines.

yielding results that were never thought of. Henke mentioned this when questioned about the work during an open forum at the Loop Conference, Berlin, 2016.

The thesis now moves onto the final section in this chapter to explore how these vibrant objects interact with each other and their relations through what Louis Althusser would describe as a 'materialism of the encounter' (2006) within assemblages.

2.4 Vital Assemblages

Keywords: Assemblages, Collectives, Prehension, Intra-action, Difference, Hyperobjects, Dust

The previous sections have already explored the term of *assemblages* throughout so it is important to understand how they fit within this thesis of *transmission+interference*. Assemblages is referred to throughout the thesis, especially so in Chapter 4: Workshops, so at this stage it is necessary to introduce the concept to set up an understanding of objects and machines working not in solitary units but with and through each other. A discourse of assemblages moves the thesis further away from the linear, unitary approaches of OOO lists and into the messy, noisy, entangled event spaces (Bennett, 2010a) made of affecting connections, difference, rhythms, and feelings resonating as a vibratory machine in its becoming.

This section will firstly begin with a return to Levi Bryant and his machines of machine-oriented ontology (MOO). Across *transmission+interference* objects and machines are interacting with(in) each other that highlight the fact that there are certain connections between certain objects / machines. As previously mentioned in the first section of this chapter, Bryant is keen to explore how machines are open to each other and how this enables specific new machines to emerge from within (his example of H₂O). He develops this line of thought from Maturana and Varela (1992) through the concept of the 'structurally open' machine (2014) which explores how connections form across machines. It is not the case that all machines can form

connections with all flows available but that they are *open* to a small subset of flows and this differs according to the structure of each machine. As also previously mentioned, all objects interacting reveal only certain powers that they contain in that interaction and this again is according to the flows that they are each *structurally open* to through their endo and exo-relations. All newly emerging machines are the result of selective openings in the structures of machines to the flows between them. The 10k resistor is open to the electrical signal flows from an integrated circuit which, itself is structurally open to a range of inputs, such as the turning of a potentiometer or the signal from a light dependent resistor (LDR) (see previous Fig. 51.). This thinking draws attention to not only the objects and machines in themselves but also the object of what lies in-between to suggest, following Whitehead, that objects and machines are never complete entities and that to think that way 'leaves out of account the interconnections of things' (Whitehead in Shaviro, 2014, p. 31). This space of interconnections between objects (things) is not a dead void for Whitehead but an active, lively, and, following Bennett, vital space of feelings between things, 'there is no absolute gap between 'living' and 'non-living societies' (Whitehead, 1978, p. 102) Assemblages, too, are nothing without the in-between connectivity of objects as it is in this 'gap' where the signal flows either connect or are repelled according to the specific openness of each object and machine. This space of feeling, within an assemblage, as introduced by Whitehead is a root of OOO and MOO as it is this feeling that is the encounter between objects that is far greater than any knowledge of an object (Shaviro, 2014). Within the workshop assemblages of *transmission+interference* objects are in motion through the feelings encountered which are described by Whitehead through the terms

prehension and lure for feeling (1978). For Whitehead, all objects realise their potential, become what they are, through the process of prehending other objects in its environment (or Umwelt). It is in prehension that an object (or entity in Whitehead) 'registers the presence of, responds to, or is affected by another entity.' (Shaviro, 2014, p. 29) These points of prehension (for they are multiple) are where structurally open paths between objects first engage in the assemblage - in fact, *points* would better be expressed more fluidly in Deleuzian terms as *lines*⁶ to avoid any issues of fixity and rigidity that *points* within networks suggests.

Assemblages operate along lines and it is along those lines that Whitehead develops his metaphysics of feelings with the poetic *lures for feeling* which operate along with *prehensions* with the addition of a *lure* that 'may entice me, or incite me, or seduce me, or tempt me, or compel me, or even bludgeon and bully me. But in any case, it addresses me from beyond.' (ibid, p. 54) These enticements are also not only occurring for the human but in an ontologically flat

transmission+interference environment they also entice the non-human object.

These structurally open machines operating through prehending vital feelings in-between are occurring at all scales throughout nature and society. A capacitor in a circuit is equally operating along these lines of feeling towards other objects in its

6. The *line* is used by Deleuze and Guattari throughout *A Thousand Plateaus* as it offers motion and movement to matter as opposed to fixity and rigidity. Assemblages, rhizomes (chapter 4), and deterritorialization (chapter 4) develop and occur along lines allowing for discourse of flow and motion. This motion and movement is part of the process of becoming that, for Deleuze and Guattari, only occurs along lines. The concept is fully developed in the term *Line of Flight* (1987).

environment just as a solar cell is, and the fingers of human hand. The assemblage is a fluid, dynamically operating environment of multiple prehensions, multiple connections, and multiple repulsions of all objects on the move - these prehensions do not cease operating, they are continuously encountering each other and their exo-relations in new and surprising ways due to their vitality. Jim Frize developed a machine called the *hyperpot* (Bowers *et al.*, 2016) that operates in a beautifully simple and surprising way due to dealing with the lure of feeling between human users and a seemingly standard potentiometer usually used to control an analog input to control sound. A potentiometer is usually operated by physically holding and turning with the hand, the only output generated is through this interaction but Frize slightly appropriated this object to operate before it is physically touched. By adding a resistor the physical pot was now given the power of capacitive sensing and now the space where the human hand moved towards the pot became an active, signal generating space. As the hand moves towards the pot, the user is usually thinking how to turn it, what changes to make in the sound, they are feeling the affect of the physical pot and its powers, but Frize has beautifully disrupted this space with another affecting object setting up new potential from this assemblage. The *hyperpot* opens up the world of the potentiometer to new operations whilst it disrupts the usual lure of feelings with a physical object.

These encounters of objects are suggested, once more, through the poetry of Lucretius and his development of the term *clinamen* (mentioned in the opening section of this chapter), or the swerve of objects. The workshops and performances of *transmission+interference* are built upon this idea that nothing, no object or body

(to use Lucretius' term) is without the potential to become through its own actions and through the attractions and repulsions of other objects it encounters when operating in, entering, or leaving an assemblage.

'[w]hen bodies fall through empty space
Straight down, under their own weight, at a random time and place,
They swerve a little. Just enough of a swerve for you to call
It a change of course. Unless inclined to swerve, all things would fall
Right through the deep abyss like drops of rain. There would be no
Collisions, and no atom would meet atom with a blow,
And Nature thus could not have fashioned anything, full stop.'
(Lucretius, 2007, p. 42)

This is the swerve of the unknown potential held within Bryant's dark object, or the swerve that collides enabling the eruption of the rogue object. Objects are falling through the assemblage, swerving and encountering others with lively, vital collisions producing effects and the emergence of new assemblages and new machines. Vital assemblages are essential to *transmission+interference* as they deal in matter, flows, eruptions, and rhythms as living things. Lucretius' poetry works with bodies and matter (much like Bennett) which grounds the discourse a bit too heavily within materiality of objects, again, it is important to emphasise that these swerving objects that wander off course exist, as in Grosz (2017), as both material physical objects and incorporeal ideas and thoughts. These swerves, collisions, eruptions, vibrations across *transmission+interference* are the very producing powers of the assemblage; what is regarded as the affect. The objects and machines (assemblages) are defined by their powers through the open relations they have that generate actions through the capacity for an object and a machine to affect others in that assemblage. Massumi relates the affect to emotion or feeling

(2002) that objects are producing and are open to be affected by. Affect brings together the previous discourse of feelings, clinamen, and the vitality in objects into an assemblage - assemblages are produced through the affects of objects and machines and they produce further affects as they produce new assemblages through the emergence of their new powers to affect. Machines of *transmission+interference* are assembled due to specific objects and their powers to affect other objects in surprising and new ways - the flickering, broken LED produces intense crackles and bursts of noise when placed in a relationship with a solar cell and a speaker. In the case of the *LED Flicker* machine (Fig. 54), the bursts of sound setup a feeling space in-between the human and non-human, both affecting each other where the gentle movement of an LED by the hand produces affect to influence those very movements.

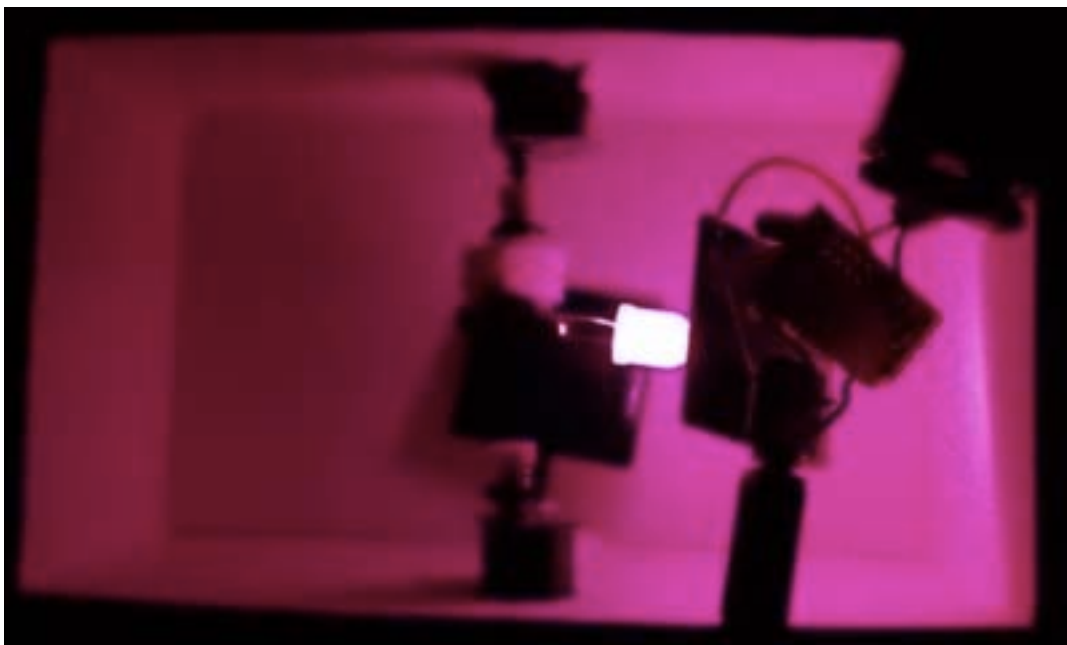

(Fig. 54. LED Flicker machine)

To conclude this section on vital assemblages the thesis will engage with the noise and dirt of *transmission+interference* through a discourse of dust - a core machine in the project that confronts the various complexities of vital materialism and assemblages. The artists and creative projects mentioned in the following section flow through into the following chapter on noise revealing the resonance between dust and noise.

Vital Assemblages: Dusty Hyperobjects

‘Dust is everything and nothing, having received particles from all that exists, but not having bestowed upon these particles a new determinate form. Dust is the medium, through which everything communes with the nothing it is about to become.’ (Marder, 2016, p. 78)



(Fig. 55. Collection of dust interfering with laser light)

The dirt of existence and past occupiers of space manifests itself as dust. Dust forms structures out of the residue of everyday life and the materials that inhabit it. It is present and not present at the same time. As Jussi Parikka (2015) reminds us, dust brings noise but not only does it perform functions of noise (disrupting, interfering) it can inform the philosopher or artist in new ways of making; new paths formed from old, (seemingly) dead materials. Dust is not a network with nodes and points of fixity, it is the perfect messy complex vital assemblage made up of difference.

Dust is capable of forming out of any combination of materials, anything that has been ground down to a fine grain over time. Materials can join and add to the complex nature of dust just as easily as they can be removed. Dust can, therefore, be thought of as an assemblage where objects (hair, skin etc) combine to form another object that can just as easily grow as it can collapse due to the movement of the assembled objects. Assemblages form and adjust over time never needing to form the exact same structure - they are not fixed but are fluid, in a constant state of flux where elements can easily be replaced. Due to the fine grain nature of many materials found in dust it is possible to be made from anything from human skin to deteriorating metals - it is the unwanted, undesired by humans that is eventually swept away until the next evidence of build up in the corners of rooms or objects. In the assemblage of dust all objects and machines have been thoroughly ontologically flattened - it couldn't be much flatter as each object is completely entangled with others to the point of becoming the machine of dust. The seeming similarity of materiality within dust is another aspect that it manages to hide, dust covers the fact that it is made up of difference. Both Karen Barad (through diffraction, entanglement, and intra-action) and Levi Bryant (through onticology) develop this discourse of difference as both a flattening and as an agency of new becomings. Barad's approach in this field is from within physics, in particular following Niels Bohr, and the visual difference patterning of light directed through slits onto a surface. The resulting patterns of light intensity on the far surface are made up through interference and difference due to constructive and destructive phase issues (2007). The diffractive patterns that emerge are due to difference -

dust too constructs and deconstructs according to its difference where not one object entangled within it is solely responsible for what it does or is potentially capable of doing. It is not possible to reduce the assemblage of dust down to find the most powerful agent acting in the assemblage once it has become fully entangled (Bryant, 2014). Instead it is best to look to the whole assemblage for 'these entangled practices are productive, and who and what are excluded through these entangled practices matter: different intra-actions produce different phenomena.' (Barad, 2007, p. 58) *Transmission+interference* is the *entangled practice* here, so is the dust. Barad's discourse of diffraction has recently become a dominant figure in practices of difference yet it unfolds from a visual practice of looking at light patterns. It is useful within the discourse of this thesis that explores the use of LED light to create sound but in an effort to further entangle the discourse diffraction could engage with the theory of transduction coming from Simondon to give a richer understanding and feeling for difference and the energies involved in it. Transduction is more closely linked with sound, transducers being audio speakers that have no speaker cone. In *transmission+interference* transducers are applied to surfaces in order to resonate those surfaces, turning them into surfaces made from the energies of sound, of amplitude, of frequency. Transduction is the shift of energies that occurs across those surfaces and can then be visualised in the vibratory bodies of dust on those surfaces. Both diffraction and transduction are working with difference as a place of productive potential. For Simondon transduction 'is a process where a disparity or a difference is topologically or temporally restructured across some interface. It mediates different organisations of energy.' (Mackenzie, 2002, p. 25) Transduction is a process for

reorganising the difference in dust. The importance of this difference is captured by Deleuze when he states, '[e]verything which happens and everything which appears is correlated with orders of differences: differences of level, temperature, pressure, tension, potential, *difference of intensity*.' (2004, p. 280) These intensive energies of difference that Simondon introduces across surfaces that result in sonic vibrations within *transmission+interference* raise the importance of feedback within the forming of assemblages. The transducer in a sonic machine such as the *Elastic Band Drone Machine* (Fig. 56.) enables the folding back of sound onto the surface and into the vibratory output again and again, constantly forming and re-forming the assemblage through feedback.

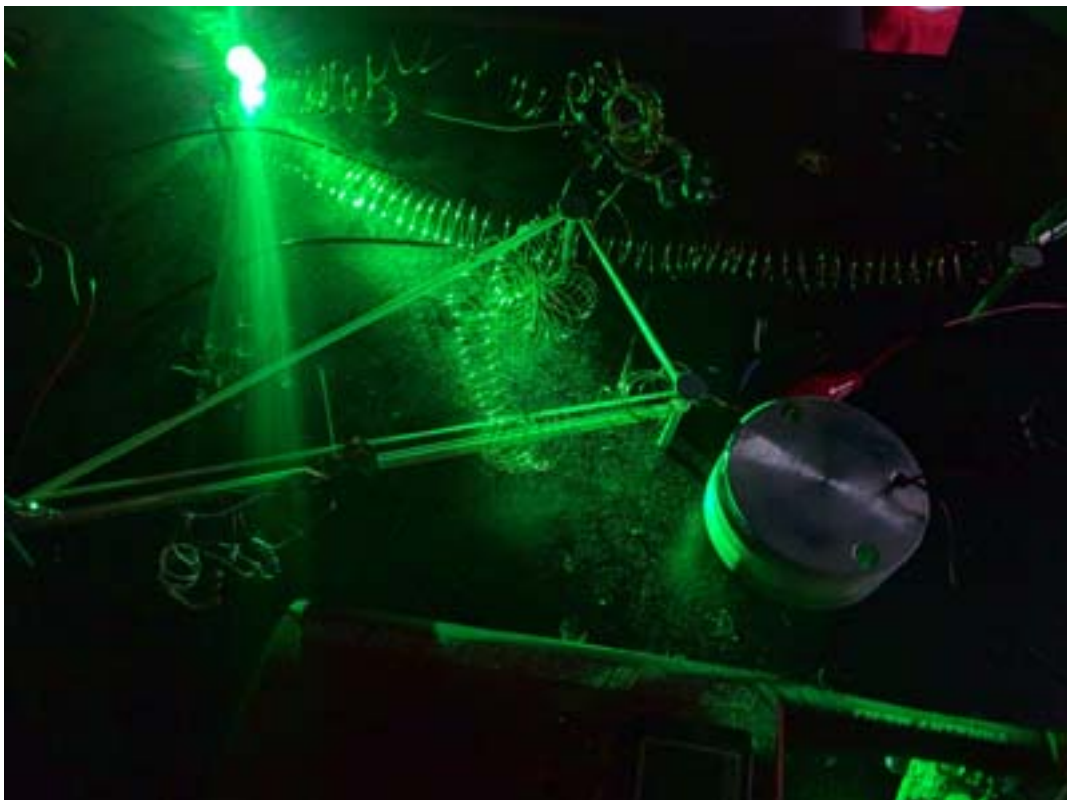

(Fig. 56. Elastic Band Drone Machine setup for live performance. The transducer is to the right of the image (circular metal object) providing sound feedback onto the machine's surface)

As it builds, dust begins to territorialize (Deleuze and Guattari, 1987) surfaces, making and breaking connections with any material structure from any previous territory swept together from disparate locations. Dust has the power to muffle or deaden sound and sound reflections, destroy playback materials, block or alter the reflective path of light - this is not a power that simply halts creativity but instead becomes creative in its assemblage with other objects. The artist, musician, and writer, Martin Howse developed a unique machine for technologically engaging with surfaces of dust, the *Laser Playback Head* which is formed of a tiny solar cell, amplifier and cheap laser pointer. The laser pointer and the solar cell are arranged in a way so that reflected laser light, returning from the surface it is pointed towards, hits the surface of the solar cell creating a sonic reading of the textures of the surface. Using Howse's *Laser Playback Head* is then in the act of searching for dust, cracks and surface anomalies to provide the device with a difference that creates sound. Each object in the assemblage of the machine is entangled in *intra-action* (Barad, 2007) with each other where upon the agencies of the laser light, the solar cell, the surface, the dust, and the materials within the dust construct a new, dusty *Laser Playback Head* through its use. The device needs dust / dirt - it then operates as an *abstract machine* (Deleuze and Guattari, 1987) moving across territories forming and re-forming assemblages of skin, metal, electronics, hair, noise and laser light. The term *abstract machine* from Deleuze and Guattari enables combinations of technical objects and human objects to be differentiated from each other. At the point where a human user picks up Howse's *Laser Playback Head* the object is no longer just a technological object - it has become abstracted from itself. The terms abstract machine and intra-action mentioned here raise the complexity of the inner

workings and the human-machinic connections that exist within the collective assemblages of dust, electronics and human. The term *abstract machine* is useful here as it denotes a machine (technological or social) that becomes abstracted from its typical use and environment through the entanglement with other objects. Through that entanglement the abstract machine is no longer performing standard functions but is now disrupted as it now operates with no predetermined function due to the objects that it is now entangled with performing acts of deterritorialisation upon it, breaking out new forms of expression previously unavailable to it (Deleuze and Guattari, 1987). The term of *intra-action* fits well with the world of the abstract machine as it moves away from the standard discourse of objects *interacting* together to create new machines. Instead intra-action suggests that the agencies operating within an object only emerge through their intra-action - they are not apparent prior to the entanglement of those objects which reflects the earlier discourse around objects with their hidden powers of affect (Barad, 2007). An abstract machine is unknown until the point of entanglement precisely because the unique objects intra-act. This emergent agency that intra-acts is the cause of the surprising sound and light combinations in *transmission+interference*, the outcomes are hidden until a participant in a workshop combines objects in a specific way - this encourages a playfulness that is picked up in Chapter 4: Workshops.

Problems arise when dealing with the multiple objects that potentially make up an assemblage. To talk of an assemblage of dust is to process that entity as one, individual object but this reduces the complexity of the object for the sake of language. To list (in the style of OOO) all the objects present within the dust would

take intensive analysis of the object and those objects that are assembled. The assemblage is created through objects and their resonance, interaction and intra-action with other objects that they are connected to. Thinking through this dusty assemblage it begins to reveal itself as a potentially complex study of individuation, autopoiesis and sympoiesis. Manuel DeLanda, by way of Deleuze, explores what he calls 'processes of individuation' (DeLanda, 2016) that explains individuation in its becoming - the dust becomes an individual ball of dust once the individual hairs, skin cells, etc have assembled but it is defined by different properties as DeLanda explains through embryology 'While the embryo is defined [...] by the experienced intensity of the foldings and stretchings, the newborn is defined by its extensive boundaries and its emergent qualities.' (DeLanda, 2016) The dust is then measured in spatial qualities and how its structure may adjust and adapt according the multiple objects in its self. This dualism of multiple and individual is the very nature of assemblages as detailed by Deleuze and Guattari, 'There are only multiplicities of multiplicities forming a single *assemblage*, operating in the same *assemblage*: packs in masses and masses in packs.' (Deleuze and Guattari, 1987) A single machine can only be formed from assembling multiple other objects. Dust becomes the ideal object with which to question the assemblage due to the fine grain makeup of its individual components that serve to highlight each object of dust as a unique entity - no two assemblages of dust are the same, as detailed by Reza Negarestani, 'each particle of dust carries with it a unique vision of matter, movement, collectivity, interaction, affect, differentiation, composition and infinite darkness' (Negarestani, 2008) though they can share the same objects in their mass collective. This individual quality is referred to by Deleuze and Guattari by the term

haecceity (Deleuze and Guattari 1987). This is the very uniqueness of the assembled object, the quality that makes *this* dust *this* one and *that* dust *that* one. The haecceity is the connections of the individual parts, it is these relations that make the assemblage a unique assemblage. With Howse's *Laser Playback Head* the haecceity emerges from the intra-actions of differing noise, squeaks and rumbles of sound as the laser moves across different materials and the dust that clings to their surfaces - each sound / object assemblage is unique. The connections and relations within the dust assemblage begin to suggest particular structures and, again, it is through Deleuze and Guattari where the link is made between the individual, the haecceity and the concept of complex networks and interconnected objects as they introduce the concept of the rhizome: 'A haecceity has neither beginning nor end, origin nor destination; it is always in the middle. [...] It is a rhizome.' (Deleuze and Guattari, 1987, p. 290) This haecceity and multiples constituting an individual will feature further in Chapter 4 on Workshops.



(Fig. 57. Live performance of *Light Entropy* (Strang, D. 2014))

Whilst dust is a useful object to explore the complexity of the assemblage it is useful here to move into other forms of assemblages to demonstrate how these concepts are valid across territories of technology, light and sound. This brings the discourse closer to particular aspects of the practical research although what will now be discussed here is an artwork from 2007 and 2014. The artwork is called *Light Entropy* (Strang, D. 2014) (Fig. 57) and is particularly useful at detailing the interconnectedness of objects within assemblages. *Light Entropy* began life as an interactive installation and morphed, by 2014, into an interactive performance. At

work in the assembled installation / performance are objects of light, heat, metal, water, ice, electronics, software, human bodies, sound and architecture. The work explores the interconnectedness of all these objects. In a dark space (complete blackout) multiple blocks of ice are suspended from random points on the ceiling. Beneath each block of ice is a large, resonant metal bowl that, too, is suspended from the ceiling in a position so that it can capture the falling droplets of water as the blocks of ice begin to melt. Frozen inside the blocks of ice are small light bulbs (not LEDs) and hydrophones (underwater microphones). Finally, the large metal bowls have contact microphones attached to them in order to amplify the sound of contact with each bowl. As the temperature within the performance / installation space rises with the bodies of the audience and performer the ice begins to melt and drip into the metal bowls. This action that is captured by the bowls triggers the light, frozen within the ice, to flash on for a random length of time then off at the same time as the sound of the falling water droplet is amplified throughout the space. As the molecular structure of the ice begins to alter more and more due to the heat of both the audience and the light bulb the cracks and pops of air are amplified throughout the space from the hydrophones. A cyclical network of decay is set in motion where each object is connected to every other object, including the sound. When the sound triggers particular frequencies that match those of the metal bowls another feedback cycle is setup between speaker and microphone only to be interrupted (or violated) by further decay of the system. This assemblage of objects is displaying Pickering's *dance of agency* (1995) where the artist is no longer in control of any elements in the work - it has become susceptible to atmospheric pressure change and is becoming only through its available relations between

objects. The connections between liquid and sound, heat and sound, light and heat, light and human bodies, metal and ice unfold throughout the artwork as new directions emerge raising interest in what is the autopoietic nature of this assemblage of objects that could be viewed as both self destructive and self making. To clarify matters of autopoiesis it is necessary to return to dust as it 'can be defined as a system capable of sustaining itself due to a network of reactions which continuously regenerate the components - and this from within the boundary "of its own making."' (Capra and Luisi, 2014, p. 134) This concept of autopoiesis developed by Maturana and Varela functions to develop discourse around the ability for life to self generate and has been useful to deal with complex assemblages of individual objects that each have their own agency that enable new direction, movement or life to be expressed by the assemblage. However, within the assemblage of *transmission+interference* it is necessary to move on from an autopoietic view so as to truly engage with all objects in the flattest way possible. Recently, Donna Haraway has developed a theory around sympoiesis - 'making-with' (Haraway, 2016) and within it Haraway challenges the individual's ability to truly self-generate or self-organize by exploring the world of objects that are always interconnected and never alone. Sympoiesis, which Haraway details as 'a word for worlding-with, in company' (Haraway, 2016), will be further explored in Chapter 4 on Workshops but for now it is useful to mention as it presents a challenge to the concept of autopoiesis. Making and creating is occurring all the time in the assemblage but the outputs of those creations are the result of multiple objects connected to every other object. The dust building up in the corner of the room

deadens a specific frequency of sound reflecting in the space precisely because of each individual object's acoustic properties in that specific assemblage of dust.

To complete this section on objects there is one final object to bring into the fold of *transmission+interference* which is developed by Timothy Morton (a philosopher from within the OOO tradition): *hyperobjects* (2013). Dust is an object that shifts between the various categories defined so far. It is a dark object, a dim object, a satellite, a rogue object, it is vital, vibratory, resonant and swerving throughout the practice of *transmission+interference* - nothing is able to escape the black hole of dust. Dust is the hyperobject of all - covering over and in-between workshop, performance, sound, noise, object, light, human. Between touch, sight, hearing and thought. There are specific qualities to a hyperobject that are equally held by dust that shall be detailed here. Those qualities are: viscosity, non-locality, phasing, and interobjectivity. The initial comment to make regarding hyperobjects is in relation to the OOO positioning of engaging with an object that does not reveal all its powers except this is now occurring on a scale out of reach of humans. As Morton himself prefaces his text on hyperobjects, in answer to his opening question of 'What are Hyperobjects?' He replies through a text by Percy Shelley: 'The awful shadow of some unseen power.' (Morton, 2013, p. 25) Glimpses of dust appear within *transmission+interference* through agencies of vibration in both sound and light but it is not possible to experience dust as a whole and to grasp its total potential within our knowledge. It enters and leaves the assemblage as speedily as objects enter and leave the hyperobject of dust. This introduces the first point of the hyperobject, that dust exists continuously shifting in and out of phase with both itself and with its

Umwelt. The existence of different forms of matter that degrade down into dust occurs across different times and displays both the *temporal undulation* and *phasing* that Morton suggests are elements of the hyperobject. Dust continues at speeds unknown to *transmission+interference* where it occasionally is brought into performing through the use of, for example, transducers applied to a surface. When these transducers set surfaces into vibration the particles of dust are set into motion at their speeds and are useful as key interferences within light signals that are then amplified through solar cell / amplifier machines. The application of transducers and sonic vibrations is entangling with the particular vibratory motion that already exists within this vital material, before the sonic waves of energy are distributed throughout the surface there exists the vibratory rhythm inherent within objects that make them exist (Bachelard 2000). The practice of *transmission+interference* is entangled with unknown temporal undulations of dust resulting in surprising light interference and sonic eruptions. It is not possible to experience these temporal undulations in standard human concepts of time and speed as dust shifts in and out of phase with humans; in and out of phase with objects; in and out of phase with workshops; in and out of phase with performances. Owing to its complex entanglement of matter, dust also shifts in and out of phase with itself. This phasing within and without dust is a setting of rhythmic patterning according to temporal and material differences involved in the making of *transmission+interference*, the bursts of sound and vibrations of light are occurring in ways set by these differences.

These phase shifts and temporal undulations are both elements of how hyperobjects achieve *non-locality*. Temporally hyperobjects are always out of reach of humans so that the full hyperobject can never be known or even experienced - humans only grasp glimpses of them as they shift into view. The dust within a *transmission+interference* performance has a non-local quality as the material structure of dust cannot be known in that performance, the cloud of dust that has produced what is experienced is not accessible to the performers or audience. What is experienced only happens due to the rhythms at that time but this is not to say that other rhythm producing vibrations do not exist out of human grasp within the hyperobject of dust, only that they may not shift into our experience, into human time and locality. They are non-local in scale too - the objects, machines, matter, bodies, and agencies involved in the creation of dust on the surface of a solar cell in *transmission+interference* workshop are beyond that object and that experience of space but they still have affect upon the workshop. As suggested by Amitav Ghosh in this book exploring vital, lively matter within climate change, 'that cyclonic activity in the Arabian Sea is also likely to intensify because of the cloud of dust and pollution that now hangs over the Indian subcontinent and its surrounding waters: this too is contributing to changes in the region's wind patterns.' (2017, p. 41)

Running a *transmission+interference* workshop in Beijing during a week when winds are intensifying across the Gobi desert results in different material make up of dust across the workshop space, across the objects of the practice.

The *viscosity* of hyperobjects relates well to Deleuze and Guattari's assemblages (especially rhizomatic ones) as it essentially elaborates that the hyperobject is never

something that can be pointed at 'over there' or experienced from a distance, instead we are in the middle of it at all times, it is on us, around us, stuck to us and everything else as a viscous object. Dust populates our every moment on earth, it's just that in *transmission+interference* we draw attention to it with machines of sound and light, but that performative dust cannot be experienced out from under the cloud of dust (following Ghosh) that produces it. *Transmission+interference* is operating in order to shift the attention of human and non-human objects into phase with dust (and noise), to try and exploit this viscosity of always being in dust for its rhythmic potential.

The final element of the hyperobject is its *interobjectivity*, something that resonates with previous discourse in this thesis as it operates in the spaces between objects, a resonating interconnectivity between all things - in *transmission+interference* between all objects and machines. Dust operates as the *mesh* (Morton, 2013) of an interobjective system creating connectivity between all objects through resonant feedback. It engages with the relations of objects as well as the objects itself, as stated by Morton, '*mesh* means the threads and the holes between the threads.' (2013, p. 83). The term *mesh* provides a good way of understanding the interconnectivity of objects in Morton's world but does limit the discourse to a weighted view of physical stuff, of materiality again, where it should not only be of the non-human but also not grounded in materiality and therefore include the incorporeal.

Dust perfectly shifts roles as an object that moves from (seemingly) out of view to being central in *transmission+interference*. It is always there, operating, at the very least, as what Harman would describe as *black noise* 'hovering at the fringes of our attention.' (Harman, 2005, p. 183) As is developed in the next chapter, dust is noise that we cannot shift from our attention and therefore should fold it in to the (sonically) noisy performances, mixing the black noise of objects with the many colours of noise in sound.

2.5 Conclusion: Objects

This chapter has introduced a variety of terms to use for the objects that are involved in the development of *transmission+interference* that has resulted in the reasoning for using the terms *object* and *machine*. Whilst, following Bryant's MOO, it is claimed that everything is a machine (2014) it would be confusing to identify all that makes up the sound and light machines of the practice as only machines. A resistor or a blob of solder do act in machinic ways with flows that structurally open to flows of certain other machines. However, for the purposes of this thesis that involves a practice whereby separate functioning parts are assembled into larger technical machines it is still useful to differentiate between objects and machines and, therefore, include both terms - just as Bryant does even when he tries to completely avoid the term *object*. Objects are involved in the development of new machines, they are assembled to construct new machines but it is still necessary to discuss those parts of machines as objects simply to enable a discourse of the objects that assemble and then the emerging sound and light machines that emerge from that assemblage of objects. Both objects and machines operate in the same ways, through their powers and vitality. They are equally able to withdraw into the background and have less influence - the object of a vibration motor might have a limited impact upon the operation of a machine, acting as a satellite object or dim object and the same can be expressed with emergent machines of the practice in a performance or workshop. The *Circle Draw* machine might operate dimly in sections of a performance and then burst into action as a rogue machine. To develop

Bogost's phrase about equality it could be then said that within *transmission+interference* all objects *and machines* equally exist.

The potential within material and immaterial objects and machines was raised through a discourse emerging from new materialism that resulted in the introduction of the core noisy *hyper-object* of dust as it offers the most complex view of the material and immaterial worlds. Dust, when understood as a *hyperobject*, floats between the terms of object and machine suggestive of the degrees in-between these two binary positions (following Serres' discourse on fuzzy logic from earlier) which is precisely the lure of the term hyperobject, as something that is accessible but not at the scale of experiencing it in its vast totality. Through dust it is possible to experience a vitality in objects and machines that have a direction of affect as well as understand the importance of assemblages that actively engages with the relations and feeling in the gaps and voids. Dust is able to suggest how the hierarchical view of objects and machines from the perspective of the human must be kept in check and that a greater potential is able to unfold when these worlds of (hyper)objects and machines are flattened.

Much can be creatively developed when there is awareness of black noise objects hovering at the fringes of perception (Harman, 2005) for they contain hidden powers that are able to erupt in surprising and exciting ways.

Chapter 3: Noise

3.1 Introduction

Keywords: Rhythm, Resonance, Interference, Dust, Sonic Arts, Information Theory, Steganography, Rupture

The aim of this chapter is to present an overview of noise throughout the research practice and position its importance within the field of making from within the context of new media art and sonic arts practices. Throughout this chapter noise will be encountered in various forms to develop a discourse highlighting its creative potential. Noise is both sonic input / output and information, bringing together the fields of sonic arts and music and information and systems theory. Within *transmission+interference*, noise is the signal and the interference, creating and disrupting through creative artistic practice and knowledge. It is the input, the materialist filter, the human involvement, the boundary of interaction, the physical mess, the (sonic) output, the interruption, and the working process. Noise is encountered in all and is embraced in order to noisily claim its territories of influence. This thesis is about making *with* noise - in collaboration with noise - and here we encounter that noise.

The chapter will begin from the development of sonic arts practice through a discourse of Yasunao Tone leading into John Cage and Nicolas Collins. It is here where the thesis explores the development and use of noise in sound practices (performance, installations) and the subsequent cultural and technological shifts that enabled noise to rightfully be positioned within the frame of critical musical discourse. This will introduce noise in its sonic form as well as introducing elements

of the noise in making and breaking of technical machines (CD players, radios etc). The chapter will then develop this discourse by exploring the field of information theory, in particular, the work of Claude Shannon and Warren Weaver and highlight the installation of *transmission+interference: digital synesthesia* critically combining this field with media arts installation practice. The flows and influence of information around the topic of noise is then developed into the section around territories, highlighting particular objects and machines utilised in the transmission and reception of signal information. Finally, the thesis returns to the hyperobject of dust to explore its potential powers of noise, initially in traditional media players before linking with machines emerging from workshops specifically operating with dust.

This chapter operates in-between the introductory chapter on objects and machines to provide a link with the making operations of the final chapter on workshops. It continues to explore noise as ontologically flattened as the other objects within the practice and with a vital materialism itself that has immense powers of affect over human and non-humans.

3.2 Sonic Noise

Keywords: Noise, Sonic Arts, Rhythm, Resonance

To begin this section regarding the exploration of noise in *transmission+interference* it is useful to examine noise within the Wounded CD works of the Japanese artist Yasunao Tone and in particular the performance *Music for 2 CD Players* (1985). In this work Tone uses material carriers of sound and data / information (compact discs) and physically manipulates them in order to realise a new sonic output that is abrasive to the ear and shocking to the listener. Tone physically abuses the discs in many ways by scratching, burning, and applying materials, such as Scotch tape, to the read surface of CDs containing music and the result is an experience where the CD player is unable to correctly play the intended information contained on the disc. The work is performed live (there were no recordings or albums released apart from *Solo for Wounded CD* (1995)) and, at an initial glance, the setup is reminiscent of standard DJ setups, he uses 2 CD players, but that is where any standard approach to digital audio performance ends. The sonic output can be said to be performed by both Tone and the discs and the CD players - he has established an assemblage between the technical equipment, himself, and the materials used to disrupt the playback and create noise from a digital system that is designed to minimise noise to a high degree. These works by Tone introduce many aspects of noise within *transmission+interference*, namely: hardware hacking, sonic arts, performance and information theory. The performances of Tone's Wounded CDs are arrived at by investigating physical hardware that produces sound in an effort to realise an alternative method of sound production that reflects the writing of Laszlo Moholy-

Nagy when he states, in 1922, that ‘we must strive to turn the apparatuses (instruments) used so far only for reproductive purposes into ones that can be used for productive purposes as well.’ (Moholy-Nagy, 2006, p. 331) Here, Moholy-Nagy is developing the concept of appropriating the phonograph from a machine that simply plays back (reproduces) audio embedded on discs into one that can be used for creative, sonic production. Tone has appropriated the assemblage of CD and CD player into a new sound producer with chaotic and unexpected results through a re-reading of the technology’s operation manuals (working against the grain of the intended use of the machine) in order to unlock further sonic potential through a ‘playing’ of the patterns of 1s and 0s that are recorded on the discs. When the discs are played, the laser of the player that is used to read the information is disrupted by the physical manipulation done by Tone and instead of producing the intended sound of music the system outputs bursts of noise that are often, mistakenly, referred to as the sound of the CD ‘skipping’. In fact the CD and laser are not skipping about in a manner that is more related to a record stylus becoming physically stuck in a vinyl record groove, ‘[i]nstead, the skips and stutters that we hear when playing a CD are errors being emitted from the system as audio. The ticks and pops are due to binary values being read incorrectly’. (Stuart in Hainge, 2013, p. 131) or as Tone himself puts it, when in conversation with Christian Marclay: ‘It’s not really skipping. It’s distorting information.’ (Tone in Hainge, 2013, p. 132) Tone is performing with distorted information, the output from each disc, each time he plays it, is unknown to both him and the audience, therefore, positioning these works within the field of sonic arts practice, and in particular, under the influence of John Cage. He has established a system that has certain rules and

structures (this is not completely random) but the actual sonic output is indeterminate - there is no way for the performer to know what sounds will be produced by the collective assemblage throughout the performance. In addition to the link to Cage through how the works are indeterminate Tone called his wounded CDs 'prepared CDs' after Cage's 'prepared piano'. It is important to note that these works by Tone were initially produced in 1985, during the early period of CD manufacturing. The audience at his performances were unlikely to have experienced the playing of CDs themselves but would be aware of the promise afforded by the technology in regards to its noise reduction, this was the main selling point around CDs and digital sound sound systems at the time, and faithfully clean sound reproduction. For Tone to deviate from this intention of clean, digital sound positions his work as one of the earliest forms of Post-Digital (Cascone, 2000) sound production, pushing beyond the limitations of a digital system before most people had even experienced the system in a standard setting. The audience at the early performances by Tone were experiencing early forms of glitch as an intentional form of producing art where the errors are the intended outcome.

This discourse that outlines the working process and performance of Yasunao Tone serves as a touching point for much noise based performance work and *transmission+interference* is entangled within this noisy discourse. The sonic output from the machines developed within *transmission+interference*, as well as from the performances, belongs in a discourse of noise. Each machine, when developed in workshops, is intentionally pushed to its sonic limits in order to allow for its powers to be fully realised and this, in following Tone's approach with the CD player, means

that the maker will have to deviate from the use of a product that the manufacturer intended. As Tone states,

‘A new technology, a new medium appears, and the artist usually enlarges the use of the technology... Deviates... The manufacturers always force us to use a product their way... however people occasionally find a way to deviate from the original purpose of the medium and develop a totally new field.’ (Tone, cited in Kelly, p. 239)

The idea that ‘the artist enlarges’ usage of a technology is interesting to consider from a perspective of noise. One of the most common forms of noise (in both the sound and visual field) is white noise which produces all possible frequencies at all intensities - thus, it contains all possible sound. One of the most common explorations of this concept is subtractive synthesis where the artist begins with a noise source and then sculpts that field of frequencies by removing (subtracting) specific frequencies until a desired sound is achieved. White noise could then be said to be the ‘largest’ sound, containing all the frequencies that make up all possible sound, thus suggesting that in order to deviate from the intended use of a technology we should use noise to achieve the fullest results. Noise is both a way to approach opening up (or enlarging) a technology and also a way to understand what it can do beyond its original limited scope. Within the practices of hacking and appropriating technologies it is not always the case that the person doing the work will fully know and understand the technologies they are working with (see discourse on tinkering in Chapter 4: Workshops) and will therefore approach the tools in a noisier manner than a skilled engineer, for example. This has been an approach long developed within sound production as Pierre Schaeffer notes, when

discussing early methods of making musique concrete, '[h]aving come to the studio to 'make noises speak,' I stumble onto music' (Schaeffer in LaBelle, 2006, p. 27)

Schaeffer is exploring the potential of sound equipment in a studio and states that he begins with noise in the process - both a sonic noise as a place to begin sculpting sound and as a method of noise through his various stumbles around and within the technologies at hand. Schaeffer's 'stumbling' is a wandering throughout the sonic and machinic powers and forces of resonance enabling an opening up of the potential of sound through increasingly realising the potential of the technologies in a noisy and chaotic way. There is an intention though - to realise new sounds, unearth them from within the technologies. Here we experience music as an emergent property of noise that will be returned to when we discuss white noise later in this chapter. In the case of *transmission+interference* and the various machines developed within it it is more useful to consider the term 'opening up' technologies instead of 'enlarging' as this links far better with the making process that will be introduced in Chapter 4: Workshops. The sonic practice most commonly related to the opening up of machines and technological components in order to actively create irregular connections (from the manufacturer's perspective) is known as Circuit Bending which was developed by accident in the late 1960s and is mostly attributed to Reed Ghazala, although there is a clear lineage back through the works of composers such as David Tudor and in particular his work 'Rainforest IV' (1968) working with objects and contact microphones. Famously, Circuit Bending emerged when 'Ghazala encountered the sounds of accidental circuit interaction: an open amplifier left in his desk drawer shorted against some metal and began whistling.' (Collins, p. 106) This literal 'opening up' of technology has led to artists

exploring the inner circuits of technologies instead of the manufacturer's intended interfaces (of keys or buttons or dials) to create new sounds and, yet again, it was a noisy action or 'accident' that enabled the emergence of this new practice. Peter Blamey's 'open electronics' performances of *Forage* (2012) are a clear progression from the early developments and accidents of circuit bending where his sound making circuits are laid out, open and exposed to the elements and have been covered in a chaotic mess of thin copper wire strands (the insides of old speaker cables) which make and break connections on the circuit boards upon which they are chaotically distributed. The raw bursts of noise from this setup fluctuate as the copper wire shifts around on the surface of the circuits by being gently blown or moved by hand, these gentle movements in contrast to the violent, indeterminate noise created. There is no way for Blamey to fully control the mess of copper wire - it is itself a noise and this use of noise as the input or as the trigger to a sound making process mirrors that of the 'Schmitt trigger' (Fig. 58) which is a small oscillator circuit, often built using a 555 timer Integrated Circuit (itself a key component in *transmission+interference*), designed to create signal from an input of noise. This simple circuit functions through a process of feedback and resonance (more of this later) to use a signal of noise as a method for generating a smooth oscillator signal. It is not the intention within *transmission+interference* to necessarily produce smooth signals but by approaching the making process in a noisy, stumbling manner there are similarities, or resonances, between the Schmitt trigger's use of noise and *transmission+interference*'s use of noise. In discussing the work of both Peter Blamey and Yasunao Tone there have been instances of the term *control* appearing that can seemingly sit in opposition to the concept of noise.

Noise can be thought of as being out-of-control or set free from any controlling factors but there still exists elements of control throughout the machines involved in the creation of noise. Through the development of indeterminacy from Cage there is the founding concept within sound and music of how to allow for chance and randomness to potentially create noise without the overbearing control of a traditional composer figure and this is developed through Bogost's Alien Phenomenology to fully flatten the hierarchies of control. When control is mentioned within this thesis it is control *across* equally existing objects, not through positions of overcoding, and their relations where some objects (bright ones, for example, which have the greatest influence upon objects in an assemblage) do have the power to control others that are in orbit of them (satellites which are objects caught in the orbit of bright objects and influenced by their powers).

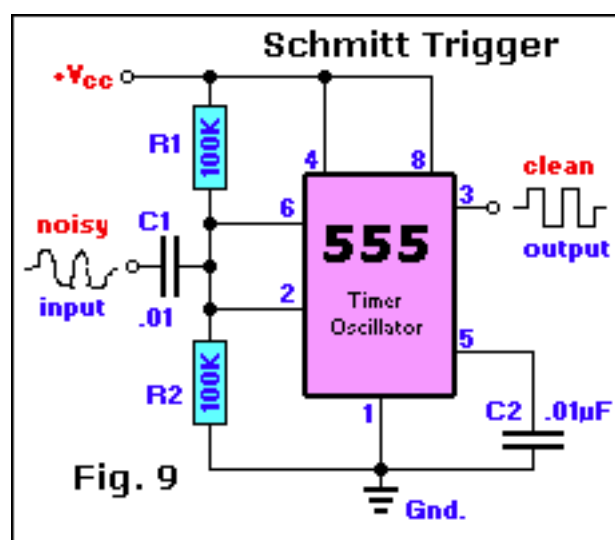

(Fig. 58. Schmitt Trigger circuit using noise as input source)

The technologies at hand in the workshops of *transmission+interference* are opened up to allow the noise to spill (more of this below) from within them. The perfect

example of opening a technology up with noise in order to experience noise is present in the machine *LED Flicker* (2015) (Fig. 59). In this machine the LED is used as a sound making machine in a very simple way. The positive and negative pins of the LED are positioned around a 3V cell battery, much like in the style of the *LED Throwies* (No Date) (Fig. 60) developed in the Graffiti Research Lab project. However, instead of creating a permanently glowing LED, one of the pins is positioned only loosely close to the battery surface where any slight vibration or movement will cause the connection to close and open creating a chaotic flickering of the LED. In order to provide the movement the LED and 3V cell battery are attached to a geared DC motor slowly turning but creating enough movement to flicker the LED. When the resulting light from the flickering LED hits the surface of a solar cell plugged into a speaker then bursts of harsh sound are generated in chaotic rhythms. This assemblage of objects (an assemblage that includes the object of the space in-between the LED leg and the surface of the battery) has opened up a new sonic potential that is noisy, it's sounds are aesthetically reminiscent of the bursts of sound created from the Wounded CDs of Yasuano Tone, but the process of achieving this output is also noisy - playing with the objects and assembling them in a way where they are closer to falling apart with each turn of the DC motor and with every wave of sonic energy that physically resonates through the machine. This links to the concept of entropy, from thermodynamics, as a measure of disorder within a system - the more disorder, the higher the entropy. The *LED Flicker* machine displays a high level of entropy as it is built with disorder in mind. It is unknown to the performer using it what sound it will

make or how long it will last before completely falling apart. This concept of entropy links to the following text in the thesis around noise and excess.

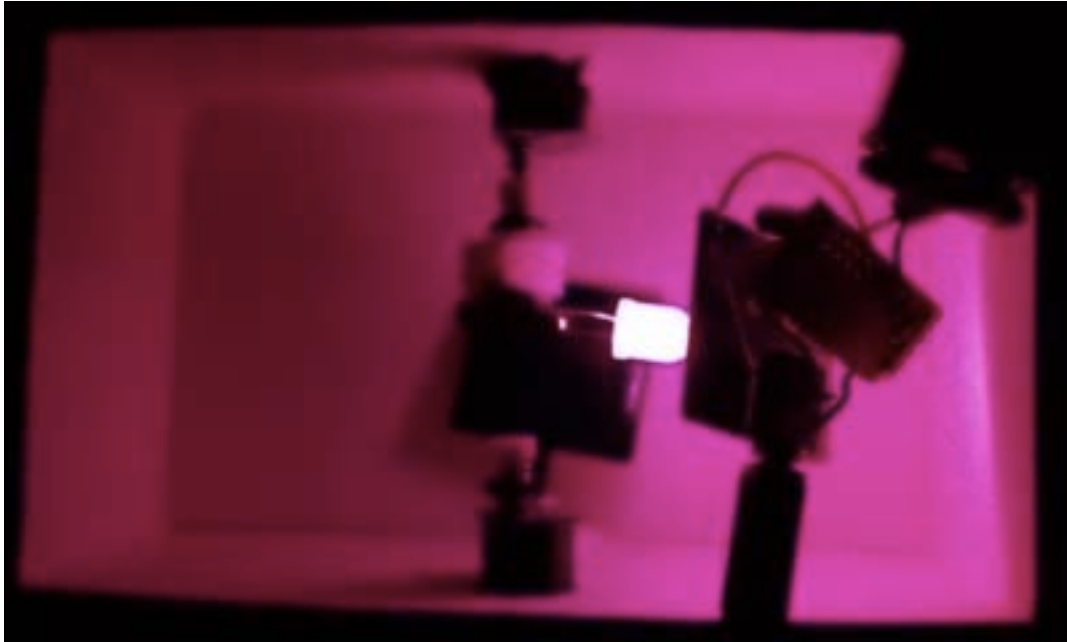

(Fig. 59. The *LED Flicker* (2015) machine. Pink LED attached to a geared motor, 2 solar cells (one beneath the LED and motor and one to the right, above the LED) contained in a small box)



(Fig. 60. LED Throwies being constructed, Graffiti Research Lab)

Once these technologies have been opened up and noise is freely encouraged to wander amongst the machines and their objects what emerges is a development of the idea mentioned above where noise ‘spills’ out from the machines and this action connects with the term *zao* as introduced in the text *The Laundromat by the Sea* (2014) by Chinese artist Yan Jun. *Zao*, in classical Chinese, refers to noise as an excess of sound which links noise to the concept of entropy, mentioned above. This noise, this excess of sound is too much for the machines to contain and spills out of them to flow over the surfaces of other machines and other excess sounds creating a resonance of noise in the in-between space. This spilling out of noise is due to the high levels of disorder (entropy) in both the physical mechanics of the machines and in the sound itself. *The Laundromat by the Sea* was a provocation set by Yan Jun in a call for noise artists to consider for an evening of performance curated by Jun and John Richards at The Phoenix in Leicester , UK in 2016. In direct consideration of this term *zao*, the *transmission+interference* performance expanded upon the use of the *Elastic Band Drone Machine* to vibrate not only physical materials (elastic bands) but to also cause fluctuations of FM radio signal. The setup for this performance included the use of coils and springs which are common objects within this field of materials focused sonic arts practice and were the core focus of making in the *transmission+interference* workshop presented at *ISSTA* (2017). For example, a metal spring or coil can act as a reverb effect when attached to a speaker cone at one end and a contact mic at the other (see Nicolas Collins, 2009), however, it is also possible to open up these coils to enable a sonic connection with the electromagnetic sphere. A telephone pickup coil is a device that is simply a coil consisting of 100s of turns of wire tightly packed together and when it is placed in

close proximity to electrical devices it is possible to amplify the noise of the electronic components working - we are hearing their *zao*, excess of sound. For the performance in Leicester the *EBDM* was covered with various coils picking up the electromagnetic pulses of the vibration motors, the Arduino board, and the sound transducers creating a further layer of noise in resonance with the machine. In addition to this use of coils as a method for picking up or exposing hidden audio signals was the use of coils to transmit sounds across a small space. This connects with the discourse in the opening section (the introduction to LED Transmission within the *Practice: Transmitting, Receiving, and Interfering*) of the thesis introducing the practice of *transmission+interference* where the mini FM project of Tetsuo Kogawa is a machine of interest in the beginning of the technological tinkering of *transmission+interference*. In this expansion of the *EBDM*, coils, which are being used to pick up hidden signals, are also being used as antennae to broadcast vibrations into the aether to be picked up by small radio receivers placed around the machine (Fig. 61). What is created in this setup is a machine overflowing with resonant noise, looping back into itself.

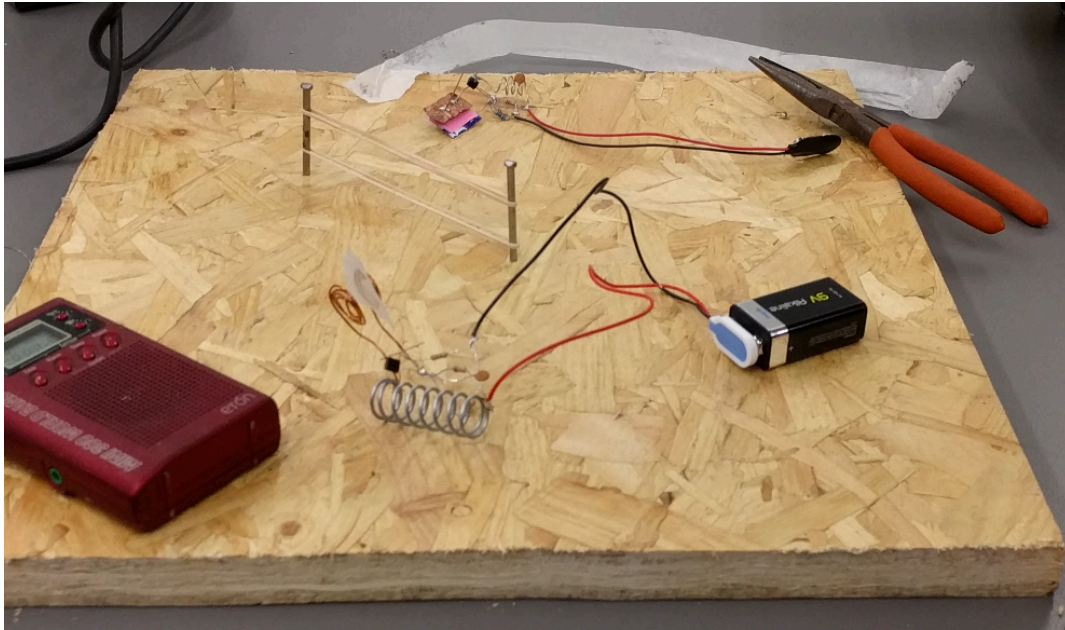

(Fig. 61. Coils used as FM broadcasters from ISSTA (2017) workshop)

During a *transmission+interference* performance the various machines are distributed across tables or the floor and set into motion by the performers, then attended to, adjusted, until a desired output is arrived at. Each machine is set up producing sound and light whilst other machines are activated or adjusted and over time multiple machines are set running, each producing light and sound which form an assemblage of audio / visual output. What is actually experienced by the audience is a resonant body of sound and light produced by the spaces in-between each machine, for it is within these gaps where the entanglement of sonic vibration and light signal operates - the in-between is the producer that receives noise and outputs signal (see Schmitt Trigger). This concept of the in-between resonating space acting as producer refers back to Massumi's comment in Chapter 2 around an echo that occurs out of the space *between* two walls (2002). Between the distributed machines resonance builds up through cybernetic feedback loops producing chaotic rhythms indeterminate to both the performer and the audience.

As stated by Deleuze and Guattari, 'what chaos and rhythm have in common is the in-between.' (Deleuze and Guattari, 1987, p. 345) What is established across this topography of machines, sound, noise, and light is an overall field of vibration that reflects the photographic images of Idris Kahn. In his work *Every ... Bernd and Hilla Becher / Spherical Type Gas Holders* (2004) a still image is seemingly set into noisy vibration through the use of repetition where Kahn builds up layers of images of the same object (a spherical type gas holder) and through the use of transparency layer effects reveals the difference between each layer of the image producing a single image of pulsating vibrancy entirely produced by the difference between each layer. This discourse of difference and repetition resonates with Barad, Bryant, and Deleuze from Chapter 2. Kahn's use of loops and repetition to shift away from standard photography's stillness is reflected in *transmission+interference* as many of the machines are operated through the use of oscillators (555 timers) whose processes are built upon repetitive actions but when each of these machines is operating in close proximity of each other these simple repetitions, which, when encountered on their own quickly become boring and simplistic to the ear, become entangled in a field of vibrational resonance thus creating difference or as Eleni Ikoniadou states when describing that Kahn uses 'repetition to reinvoke the vibrational energy of the event - its affective difference.' (Ikoniadou, 2014, p. 81) This 'affective difference' is experienced throughout the machines of *transmission+interference*, occurring, sonically, as phase shifts in-between signals. For example, the *LED Drum Machine* (Fig. 62) uses a series of 555 timers to each control the blink speed of an LED which is directed towards the surface of a solar cell. The resulting rhythms (reminiscent of a drum machine) occur from the

sequence patterns of light hitting the solar cell but when two 555 timers are set up with identical components (same resistors, same capacitors) they still have degrees of difference between them creating very slight phase shifts as the speed of light pulses are fractionally out of phase with each other. It is this difference in the repetitive oscillators that creates an affective listening experience - drawing the ear in. The considered exploration of the space in-between is essentially the foundations of *transmission+interference* since the development of the *LED Transmitter* machine. To transmit sound within light is an interesting and surprising event when first encountered but only becomes creatively interesting once the user actively explores the space in-between the transmitter (LED) and the receiver (solar cell). This in-between space is core to the 'interference' in *transmission+interference* - it is not the only place where interference occurs as, for example, the LED itself is interfered with through the hacking process and is then modulated by audio signal, but it is one of the clearest explorations of interference in order to generate new sound. By inserting an electric fan in the space in-between the LED and solar cell the light and thus the sound signal are modulated together to form disrupted patterns (diffractive patterns) of light that fall on the surface of the solar cell - at that point we hear the interference, we hear the in-between as an assemblage of signal transmission, interference space, and solar cell reception.

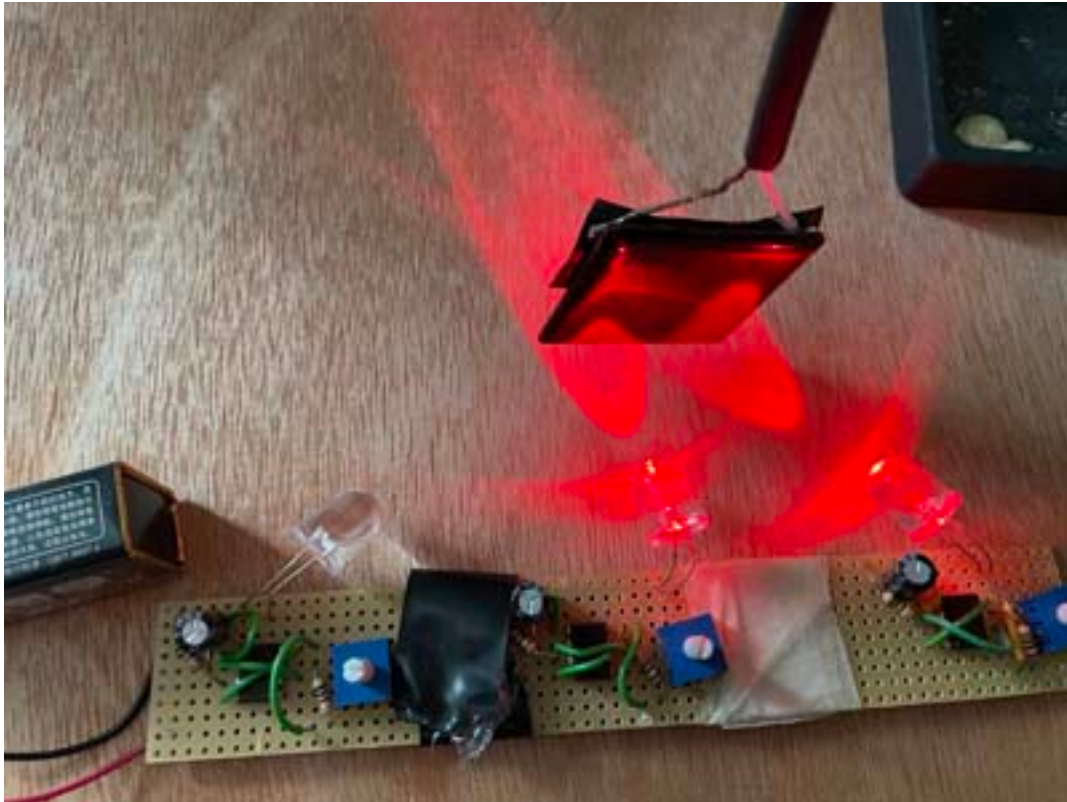

(Fig. 62 LED DrumMachine fixed version soldered on prototype board (2015))

Cage provides a link between this world of sonic arts and the creation of noise through the physical vibration of objects that connects to the discourse of vital materials discussed in Chapter 2 with the development of his theory of *panaurality*. Cage developed approaches to sound and music through an understanding of the internal resonance and vibration of physical objects, famously developing technologies (the contact microphone from the record stylus) in order to amplify these tiny vibrations for the human ear. Crucially, Cage understood, from a non-anthropocentric perspective, that objects are always making sound, it is eternally leaking from them as excess (*zao*) and thus it is then possible to be amplified and experienced by the human ear. As will be discussed later in this chapter with Nicolas Collins' hacking of a CD player mute pin, Cage exposed that sound is always in the object and that to explore object-oriented sound it was necessary to

realise that 'sound was no longer tied to events but existed as a continuous state as it resonated from each and every atom.' (Kahn, 2001, p. 159) These 'events' that Cage mentions are human centric for the purposes of the playing of music, for example, he discusses the striking of an ashtray as just such an 'event' that positions the object as a percussion instrument in an anthropocentric world. In order to develop truly non-anthropocentric fields of sound and music Cage shifts the sonic experience coming from objects to a position of listening in the human, not as an event based, striking of an object. Through an understanding coming from the perspective of physics, Cage engages with the *inner life* (entelechy or élan vital) of objects where he raises the interest in listening to the atomic vibration that is a constant production of sound and noise (Kahn, 2001).

3.3 Information Noise

Keywords: Information theory, EVP, stochastic resonance

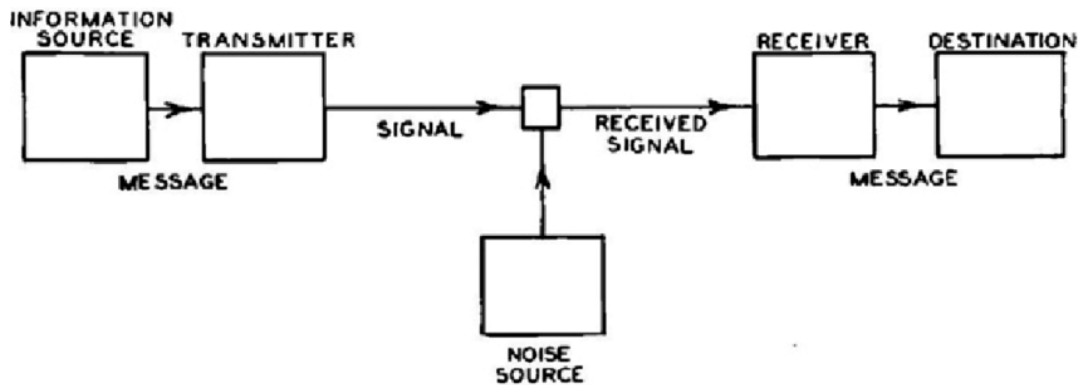

(Fig. 63. Shannon and Weaver's Mathematical Theory of Communication (1948))

At this stage it is useful to highlight a highly influential theory on which *transmission+interference* is based, Shannon and Weaver's mathematical theory of communication (1948) (Fig. 63) which was developed whilst Shannon was working at the Bell laboratories investigating how to reduce noise within the first telecommunications systems in order to clarify the intended message. The diagram of their mathematical theory of communication shows, in the broadest sense, a communication system from information source through to its intended destination and claims that noise will always be a factor in the transmission of that information.

As Weaver noted:

'In the process of being transmitted, it is unfortunately characteristic that certain things are added to the signal which were not intended by the information source. These unwanted additions may be distortions of sound (in telephony, for example) or static (in radio), or distortions in shape of shading of picture (television), or errors in transmission (telegraphy or facsimile), etc. All of the changes in the transmitted signal are called noise.' (Weaver, cited in Hainge, 2013, p. 3)

It is this diagram and theory of communication that founded the basis for the installation work *transmission+interference: digital synesthesia* (2016) (Fig. 64). In this installation, commissioned by the University of Applied Arts, Vienna for their exhibition 'Digital Synesthesia' (2016) the original LED Transmitter was developed into an open, noisy transmitter of information in the form of light, sound, and text. Across a space in the gallery the system aimed to transmit a chosen piece of text using sound and light as the carrier of information. The text chosen to transmit offered its own internal noise to the overall installation given that it contained a certain level of uncertainty of its own message:

'I... I... I... I'm the radio, I'm the tower..., with electromagnetic access everywhere at once.' (Mayakovsky, cited in Kahn, 2013 p.124)

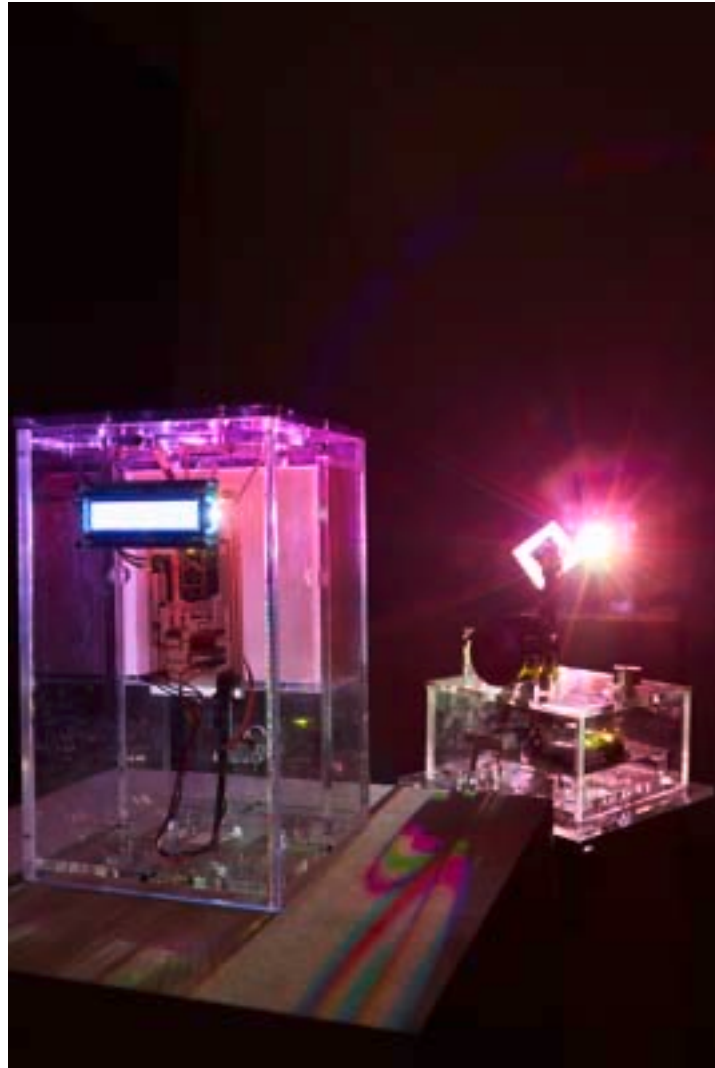

(Fig. 64 transmission+interference: digital synesthesia installation (2016))

This quote itself neatly brought together elements of the project: the message has some internal noise or uncertainty ('I... I...I...'), it is claiming to be the system of broadcast (radio, tower), and, finally, introduces the field of electromagnetism which is essential to the functioning of all of *transmission+interference* (not only this installation). If the entire message was received perfectly and intact it still had the impression that there had been some noise operating within the message with the inclusion of repeated '...'. In order to transmit the message, each communicable piece of text was translated into a combination of single colour and single audio frequency. An RGB LED was used to produce the colour output and shine across

the space from the transmitter stage towards the receiver (Fig. 65). For the colour, the receiver was a colour sensor. Within the RGB light that shone across the space was carried the matching audio frequency which travelled within the light towards the surface of a solar cell where it was then output as audible sound. This audible sound (a sine wave oscillator) was then received by a microphone at the same point as the colour sensor (the receiver) where both sound and colour were combined together again to form the transmitter text. For example, the letter 'x' could be translated into Colour = YELLOW, Sound = 470hz. If the receiver section received YELLOW + 470hz then it would print the letter 'x' on the the LCD screen of the receiver (Fig. 66). Mapping the flow of information in the installation intentionally reflects Shannon and Weaver's diagram of the mathematical theory of communication and actively explores the impact of noise upon the system due to the very nature of its open form construction.

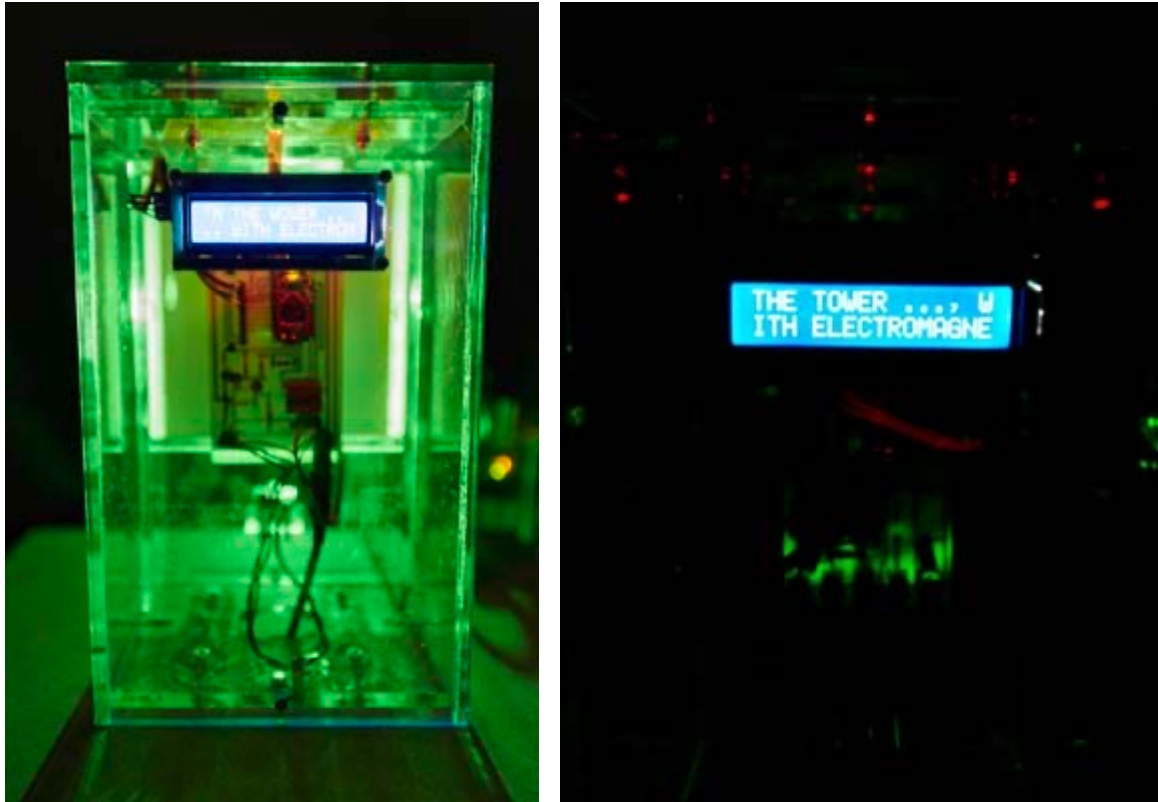

(Fig. 65 (Left image) Back of the receiver in the transmission+interference: digital synesthesia (2016) installation and Fig. 66. (Right image) Close up of text displayed on LCD screen)

Visitors to the exhibition become participants in the success or failure of the intended message by simply entering the room and moving within the work. This shift from visitor to participant is a continuation of the ontological flattening across the works of *transmission+interference* developed in Chapter 2, where the assemblage of technical objects and machines of the installation assume no position of hierarchy over participants and equally, the participants hold no position of hierarchy over the installation machine. These new bodies (objects) fold into the assemblage of the installation and then withdraw when leaving and this is picked up and developed through Hannah Arendt's concept of *natality* (2018) in the section on *DIY / DIWO* in Chapter 4 on workshops. Any sounds produced by these participants (talking, moving, phones etc) are picked up by the open microphone in the receiver

and interfere with the reception of the intended sine wave oscillator tone resulting in an error in the printed text output. Similarly, walking through the installation and blocking the coloured light will result in no colour being received. However, as participants do these actions it is not revealed to them how they are affecting the system. They act as agents of noise throughout the installation without the immediate realisation that they are affecting the transmission of the text. In fact, it is (intentionally) unclear even how the text is being transmitted as the transmission stage only appears to have the text and coloured light - there is no sound evident at that stage as it is hidden, embedded within the light signal. The installation and the objects that assemble to create it have hidden powers. The installation included a diagram (again, reflecting the diagram of mathematical theory of communication) (Fig. 67) revealing the technological structure of the work but even with this the experience of the work is noisy. The work essentially reveals how it functions but with the use of hidden signals and a level of interactivity that is so uncertain for the 'user' the work reflects comments by the artist Paul DeMarinis when discussing his use of technology in Stephen Wilson's book 'Information Arts' (2002):

'I wouldn't be comfortable with a piece that created an illusion by conventional means. For me the real illusions are the ones that still mystify even when the technology is revealed and explained.' (p. 399)

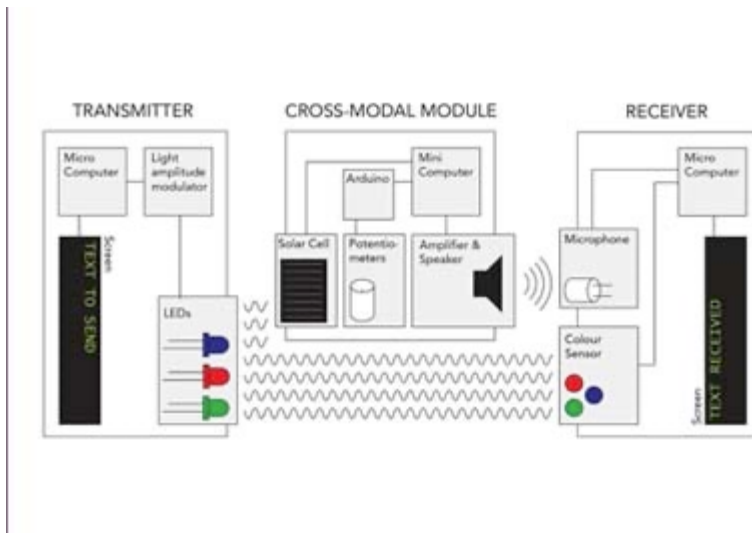

(Fig. 67. Diagram mapping the transmission of text as sound and colour within light)

The installation, therefore, playfully explores the use of noise and the affect of noise throughout not just the technological components or through just the use of noisy sounds, light, or text but it also reveals the noise in the received message at the stage of the ‘user’ which, following Peter Weibel’s thoughts on noise and the observer, has a level of ‘undesirable uncertainty’ (Weibel, 1999, p. 143). Weibel mentions this as an additional aspect of noise within Shannon and Weavers’ theory suggesting that even once a message has been successfully communicated there will always be noise ‘regarding what the message sent really was.’ (Ibid) The installation attempted to shift the use of noise at the stage of the ‘user’ into the realm of the desirable for the transmitter and receiver assemblage.

Due to the openness of the installation and its sensitivity to external noise it was a rare occurrence when the transmitted text was actually received and printed to match that of the transmitted text. Instead the installation regularly output noisy text which is another layer of noise that should be unpacked in relation to Shannon and Weaver’s theory. This brings together the work of *transmission+interference: digital*

synesthesia with thoughts about the use of text within the artwork *Wandering Snail* (2014) by the bio-arts collective RADIX (Robinson, Rundle and Strang). Part of the *Wandering Snail* installation, shown at the FIELDS exhibition, RIXC, was the use of text by the biologist Linnaeus about the discovery of *Radix balthica* (a species of sea snail). In the installation the text had a sorting algorithm (Radix Sort) applied to it in order to reveal a noisy re-reading of the text that removed the original intended message of the text (Fig. 68). The resulting text though did not communicate nothing, instead, through the noise a new type of information is revealed that is suggestive of another field of research by Claude Shannon known as *Shannon entropy* whereby the probability or uncertainty of a letter appearing next in a word or of a word appearing next in a sentence can be measured (Gleick, 2011). This example in *Wandering Snail* results in a text displaying high entropy as it becomes less likely to predict what letter or word might appear next and this relates back to discourse around entropy in the *LED Flicker* machine and excess sound or *zao* in the previous section of this chapter - entropy is a concept emerging from both fields of thermodynamics and information theory. After having the sorting algorithm applied to it, the text by Linnaeus revealed new information about its content, for example, the amount of times the word 'the' is used. The noise revealed not only the word frequency of the text but also created a new resonance between words, previously not placed together and suddenly connected in a method that extends the use of lists from within OOO practices to move beyond single objects of words and include all instances of each word. This understanding of how noise is used to reveal (new) information worked with the text of *transmission+interference: digital synesthesia* where the LCD screen now revealed the interference taking place in the

installation through its messy combinations of letters and symbols. New information appears to wander within the text. This characteristic of noise within text is experienced in the sonic field of noise too as well as becoming an integral part of computational communication systems which loops this section back around to earlier discourse around the use of white noise.

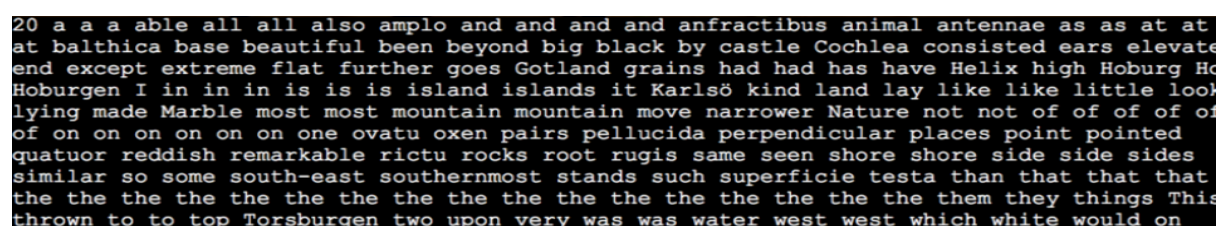

20 a a a able all all also amplo and and and and anfractibus animal antennae as as at at at at balthica base beautiful been beyond big black by castle Cochlea consisted ears elevated end except extreme flat further goes Gotland grains had had has have Helix high Hoburg Hd Hoburgen I in in in is is is island islands it Karlsö kind land lay like like little look lying made Marble most most mountain mountain move narrower Nature not not of of of of of of on on on on on on on one ovatu oxen pairs pellucida perpendicular places point pointed quatuor reddish remarkable rictu rocks root rugis same seen shore shore side side sides similar so some south-east southernmost stands such superficiei testa than that that that the the the the the the the the the the the the the the the the the the them they things This thrown to to top Torsburgen two upon very was was water west west which white would on

(Fig. 68. Extract of text by Linnaeus after Radix Sort algorithm)

In his book 'Rorschach Audio: Art & Illusion for Sound' Joe Banks introduces some interesting, and in some places very humorous, case studies in connection to certain practices of noise. One of them, Electronic Voice Phenomena (EVP), will be returned to shortly as it also raises thoughts around paranoia within hidden signal transmission but linking with previous thoughts around how noise can be used to actually reveal information Banks develops a discourse around the phenomenon of Brownian motion and its connection with the development of what is known as Stochastic Resonance. Within the ear are tiny hair follicles that enable our ability to hear. They become excited by vibrations of air molecules and the level to which they are excited relates to the sensitivity of ears to certain frequencies of sound. Our ability to hear certain frequencies (particularly high frequencies, above 16Khz) drops as we get older as the hair follicles have physically deteriorated to a point where they can no longer respond to those frequencies. However, if the hair follicles are set into motion (excited) by noise it is then theoretically possible to hear other

signals. The random, chaotic mix of frequencies and intensities that make up noise provide a platform upon which other signals become perceivable to the listener. This is a phenomenon known as ‘paracousis’, where, essentially, the weaker signals are supported by the field of noise and become clearer because of the noise. The ear wanders in the field of noise, searching for information. In Banks’ text he introduces the following case studies where:

‘A woman who was always attended by a servant with the job of beating a drum when somebody was talking to her [...], another person who heard only when bells were ringing [...], and one final individual who heard best when he was in a carriage that was jolting over cobblestones.’ (2012, pp. 37-38)

This points to a reasoning that noise is not the destroyer of meaning and is not the obscurer of information that it is labelled with culturally. When Salomé Voegelin (2010) suggests that noise is the disturbance from her downstairs neighbour’s music, obscuring her from her own thoughts, this also rings true. Noise is now both obscurer and revealer of information and at this point it is useful to return to pick up a few elements of this discourse, white noise, Electronic Voice Phenomena, and Stochastic Resonance to begin to explore the territorial nature of noise that is of interest within the machines, workshops, performances, and installation of *transmission+interference*.

3.4 Territories

Keywords: Territory, Radio, Energy, Steganography

The concept of the 'territorial' within *transmission+interference* begins with the *LED Transmitter* machine whose sole purpose is to transmit sound, to broadcast or, in fact, narrowcast it as we follow on from Kogawa's mini FM project. To broadcast or narrow-cast is to setup a field of reception beyond which the signal is not strong enough to reach or it is somehow blocked from reaching. The area of reception is the territory within which that signal can operate or can be experienced by other machines. Within the practices of sonic arts there is a strong tradition exploring one of the core technologies for developing these sonic territories - radio. In *Drive In Music* (1967) by Max Neuhaus 7 unique audio signals are broadcast from 7 radio transmitters positioned along a road. A car radio is tuned to a specific frequency and then, as the car drives along the road, the sounds from one radio transmitter fade out, are replaced with noise (radio static) before the field of the next radio transmitter is reached and another audio signal emerges through the noise to reveal itself - radio interference signals the transition point or the in-between of the radio transmitters, it marks the territory of sound just as strongly as the unique audio signals do. Noise (sound and radio interference) marks out the territories of the work (LaBelle) in a way that would not be possible in conventional music performance arenas. Neuhaus, famous for early sonic arts work in the field of sound installations, has moved from one performance area that is more traditional (concert setting) to exploring public spaces as new settings for his performances. What developed from these early works by Neuhaus is an understanding of sonic art installations in a

public setting, breaking new ground and exploring new territories for sound to perform. Radio had been a feature of many earlier works including that of John Cage in his *Imaginary Landscapes* series, in particular *Imaginary Landscape No. 4* (1951), a performance for 24 performers and 12 radios. This work is often cited for Cage's continued exploration into chance encounters with sound and indeterminate performances - each performance's sonic material is unknown to both the audience and the performers as it is set by the tuning of the radios to different channels resulting in outputting whatever was being broadcast from that station at the time. This chaotic encounter with sounds broadcast from beyond the concert venue are in themselves creating a noisy experience for performer and audience but these works are not often discussed in regards to their exploration of territory. This is what radio does best, it brings territorial markings to the surface, to be experienced. In the performances of *Imaginary Landscape No. 4* the performers are immersed directly into the field of noise, the audience watch on and listen at a distance to sounds streaming in from far afield. This work greatly extends the sonic territories of standard performance settings - in fact, extending these territories much further than Cage's most well known work *4'33"* (1952). Again, this work is rarely discussed in relation to its sonic territory even though in the performance the outside world is invited to enter the performance venue sonically as the windows are intentionally opened - for Cage this is to increase chance encounters of sound and create an indeterminate performance, not directly as an exploration of sonic territories. *Imaginary Landscape No. 4* developed an experience of noise that reached beyond the ear - the performance was heard in the venue but the signals of music, voice, interference patterns, etc stretched out into the aether and were each, individually

being heard at their respective radio station and also in other radio receivers within the field of broadcast creating a vast network of sounds reflected in the later work by the French group *Apo33* (Julien Ottavi, Emmanuel Leduc, Jean-Francois Rolez, and Sophie Gosselin) when they developed their *Poulpe* (octopus) system for audio networking using the software Pure Data (Pd). Live performances by the group were accessible in the performance venue but also in their studio and their homes where the live audio was broadcast out to - marking out a territory of performance sound for the audience to navigate through. The chance encounters encouraged by Cage in his works are achieved only through an opening up of the territory of sound and noise by altering physical architecture (windows or doors) or by employing the ethereal architecture of radio signals. Radio offers a non-local, temporally undulating, viscous, and phased space to be experienced - radio operates as a sonic hyperobject.

In the live *transmission+interference* performance for *The Laundromat by the Sea* event, radio, in its purest sense, maps a territory of noise, resonance, and rhythm through utilising the tools and processes previously mentioned above. Vibrations of the electromagnetic spectrum are picked up through coils of wire and vibrations of physical materials are sent back out into this vibrant field of radio using mini antennae. This use of radio expands the field of the performance beyond the physical components which dominate the understanding of the work - it is these physical objects that are directly being worked with by hand and are given a greater importance in the development of sound but they are far from the only elements at play once the energies of electromagnetic signals and radio are explored. Douglas

Kahn, reflecting Elizabeth Grosz's points on the incorporeal in Chapter 2, points out this shift in attention within the world of music from the material properties of instruments and sound generating machines to begin an acceptance of the energies of waves, fields, and signals, by framing instruments as 'switching mechanisms [...] at the disposal of energies' (Kahn, 2013, p. 218) As sonic arts practices developed out of the 1950s and into the 1960s this shift in attention increased with new artists willing to explore a more total field of sound as '[t]he acoustical energy of sound, once it had begun to be loosened from musical sound, offered itself as material to the arts.' (Ibid) The use of narrowcasting radio in the performance does not reach the spatial dimensions of standard radio broadcast systems but is of influence within a smaller field surrounding the immediate *Elastic Band Drone Machine*, however, this points to territories of vibration and noise still, but just on a smaller scale. Whereas the movement of a car down a stretch of road in *Drive In Music* alters the reception of radio signal, in the T+I performance reception of audio is altered with tiny adjustments of vibration motors (themselves tiny) and movements of radio receivers. The points of resonance that make up the territory of noise is understood through these movements as a receiver moves through fields of static into points where the broadcast signal is clearer. Where the territory of *Drive In Music* is expanded to the electromagnetic spectrum in the air (for example, electrical storms would affect the system and create audible interference patterns) so is the the *EBDM* affected by the same environment but also by much more local energies - the pulsing of a mobile phone signal could modulate the spectrum close to that of the radio receiver, for example. This opening up to external, unknown waves and energies affecting the sound of the performance further lifts the work out

of the material objects and is reflected in the works of artist Martin Howse. Howse often works directly with electromagnetic signals, for example, through his use of the *Detektor* (2010) machine, designed and built by Howse himself. This machine works solely to modulate signals from the electromagnetic spectrum into audible frequency - the energy of electromagnetic pulses is foregrounded as the only sound source.

The conceptual sound works of Robert Barry from 1969 offer a unique connection between Cage, energies, territorial markings of sound, radio, silence, noise, materiality, immateriality, and T+I. As sonic arts emerged as an arts practice unique from the world of music in the 1960s, and this shift in focus from the material to the immaterial, as mentioned by Kahn above, was developed alongside that of Minimalism, art gallery spaces were beginning to be challenged by an absence of material things. Sonic artists began to explore the concepts of sound and space and the interactions between them activated by sounds. At the exhibition *Spaces* at the Museum of Modern Art in 1969 Michael Asher installed a sound installation that consisted of a fixed pitch of 85Hz from an oscillator tone generator played into the gallery. The oscillator, amplifier, and speakers were hidden from view - the only visible markings of the work being the information text on the wall, the gallery now filled with sonic energy. Visitors who moved through this gallery space interacted with the tone and the space and sculpted sound with their ears as walked, creating discernibly different pitches according to their speed and direction. This work by Asher would seem to be a pinnacle moment within the crossover between sound installation and Minimalism and has certainly had a profound impact upon artists

working with sound and space (Ryoji Ikeda developed a strikingly similar piece *Spektra II* (2002)) (LaBelle, 2006), however, earlier in the same year Robert Barry had developed this concept beyond even the energies of pure oscillator tones by exploring carrier waves in radio broadcast. His installation, or series of installations, for the exhibition *January 5-31, 1969* (1969) removed even the presence of sound from the gallery space through broadcasting two powerful carrier waves, one for FM (88 mc Carrier wave) and another for AM (1600 kc Carrier Wave). These carrier waves would usually be utilised by broadcast stations to carry information (music or voice) but Barry removed any such modulation of the waves choosing instead to broadcast solely the base frequency of the carrier wave. The resulting broadcast overpowered any other information carried by a radio station on those same carrier waves, silencing any voice or music that would usually be picked up by a radio receiver. Using a radio receiver near the gallery space on a specific frequency would result in the playing of the broadcast sound but as that radio receiver moved closer to the gallery space the sound would grow quieter until completely overpowered by Barry's carrier waves to the point of silence. The visitors to the gallery are faced with a similar experience to that of Asher's installation except there is not even single tone playing, the absence of even that would make visitors believe the space is empty but, as Douglas Kahn points out, 'the space was emptied of certain radio broadcasts and filled with electromagnetic transmissions. What appeared to be an empty space was, in a way, even emptier.' (Kahn, 2013, p.221) The electromagnetic energy of the carrier waves in the space noisily interfere with, to the point of silencing and obscuring, any information originally carried in the aether on those frequencies. The territorial borders of signal and carrier wave are marked out

through noise and the absence of it too. This reflects similar effects generated in the performances of *transmission+interference*, not by using carrier waves to silence sound, but through natural phasing issues due to the physical displacement of machines and sonic energy. Throughout the performances, a machine generates a range of raw frequencies that flow out in all directions, enveloping any surrounding machines also outputting its own range of frequencies and within this field of noise there exists various points of overlapping waves that match in frequency and time thus cancelling out both waves, silencing it until at least one of those matching waves shifts in frequency or physically in space. When very low frequency sounds operate at a high enough intensity the experience of those waves shifts into a physical experience for any bodies in the field of influence. For the human body we can begin to feel parts of our body resonate and shake in response to the sonic waves hitting us and this is the same for any non-human object or machine. The extremely loud low frequency sounds send a physical vibration back through the machines generating the sound and cause them to further vibrate and move slightly across the surface. These movements are enough to shift frequencies in and out of phase so as the performance plays out there is a constant phasing effect causing signals to be silenced and released unknown to the performer. This feedback cycle of physical vibration is further developed and encouraged with the application of transducers on the surfaces of certain machines and the playing surface. These transducers, picking up from discourse on Simondon in Chapter 2, energetically operate as audio speakers playing back selected channels of sound but instead of directly vibrating air molecules like a speaker with a speaker cone would do, a transducer is vibrating the physical object that it is in direct contact with and once

that is set into motion it is that object's resonance that vibrates the air molecules enabling us to hear. In *transmission+interference* performances the transducers are not employed as loudspeakers in replacement of a PA system but are added to various points of the physical setup to encourage physical resonance through feedback cycles as well as to cause the physical shifts across the surface as mentioned above. This feedback sets all parts into motion and enables new rhythms to be generated within the performance. To add a transducer to the surface of the *Elastic Band Drone Machine* and feed that transducer with sound coming from the solar cell of *EBDM* constructs a system that begins to control itself to a certain degree. For the *EBDM* to operate an LED is directed across the surface of entangled elastic bands (suspended from nails hammered into a wooden block) which are vibrating due to tiny vibration motors wound within that entanglement. The LED light then hits the surface of the solar cell and we hear the sound of vibrating elastic bands, it is a particularly low frequency that is generated and this is then fed back onto the wooden surface of the machine through a transducer. The transducer is not fixed to the surface and thus becomes a roaming object filled with vibrational energy that moves anywhere across the wooden surface in accordance to its own frequency in resonance with that of the resonant properties of the wood, nails, elastic bands, solar cell and LED. Over time, the feedback in this system will build up the resonance to such an intensity that the machine will visibly begin to shake and the transducer will violently jump and then will settle back into a quieter oscillation until the resonance builds up again. The machine displays a new rhythm set in motion through feedback and resonance by moving from points of cancelling out waves to points of high intensity vibration - the cancelling out does not silence

the machine forever, it is simply part of the rhythm of the machine, it is part of its noise. The build up of resonance within a room and across the physical surface of a machine relates to the phenomenon of standing waves where sonic frequencies physically begin to oscillate with the architecture of the room. This is often experienced with single oscillator tones as they are useful for understanding a pure relationship between sound and space. The tones are played into a space and when their wave of oscillation physically matches the geometry of the room the reflections of sound will superpose themselves back onto the original wave and begin to create nodes of intensity and silence - areas where the sound builds up to a high intensity and areas where the sound cancels itself out. It is then possible to physically walk through these nodes in the space as they become fixed in place. The nodes where the sound builds up can become an intense listening experience, the vibrational field around you affecting your voice and hearing - you become cut off from the space by the sound and begin to resonate in response to the sound. This resonance of the body is what Maryanne Amacher describes as 'the third ear' (LaBelle, 2006, p. 75) where the resonant field of vibration becomes so intense that new overtones are created in the inner ear, entangling the listener in a unique way to the sound and space, hearing sound and generating sound that is unique to that individual.

The signals of *transmission+interference* operate in these noisy modes of generating greater intensities as well as cancelling out frequencies that suggests the playful experience of signal, information or silence being hidden within those signals. This returns the topic back to white noise and introduces the practice of Electronic Voice Phenomena (EVP) that operates in a way so as to suggest the possibility of voices

existing in the aether. EVP is practiced as a way to uncover voices hidden within spaces through the introduction of noise to that space. White noise, often from detuned radio signals, is played into a room and then that space is recorded for the purposes of listening back to sections of it, usually on repetitive loops, to analyse for the presence of hidden voices speaking back to us through the aether. The spaces affect the white noise to sculpt certain patterns of frequencies and when these looped recordings are played to an audience there are claims of hearing a voice, often a deceased friend or family member or a historically important figure from the past. This signal of voice is potentialised through the chaotic displacement of audio frequencies and intensities that is white noise flowing through a space - the voice does not exist but is usually suggested to the audience as something to listen out for. As discussed earlier, white noise carries with it the potential of any possible sound as it is made of all possible frequencies and when a listener is instructed to listen for a voice the illusion is created through a psychoacoustic effect that plays with the listener's mind. They believe that they can hear a voice speaking to them but often only when told what to listen for. This practice of EVP is highly problematic (to say the least) but does demonstrate the potential for noise to offer creativity as sonic output that would be beyond the control of the performer - suggestive signals leaking from the field of noise. The mix of noise and physical space re-territorialises the sound frequencies and intensities to enable new sound experiences to emerge. The assemblages of radio signal and electromagnetic signal and sound signal 'hint at an aether practice which offers a more definitive other side to the radio days; an aetheric noise which is neither transmission or reception.' (Howse, 2008) Noise potentially containing hidden information offers creative potential and is a practice

referred to as steganography; hidden signals within noise - hidden signals / hidden powers.

Steganography uses noise to hide the intended signal and allow for its passage across territorial borders. Again this hints at flows of electromagnetic signal spilling from electrical (or electro-mechanical) objects since the realisation that all devices leak their signal; a discovery made by NSA that led to the cover name TEMPEST:

‘Any time a machine is used to process classified information electrically, the various switches, contacts, relays and other components in that machine may emit radio frequency or acoustic energy. ... This problem of compromising radiation we have given the cover name TEMPEST.’ (NSA, 1972)

Steganography conceals the fact that there is a hidden signal, unless you are the intended recipient and are aware of the processes of decoding or unpacking that signal. Classical examples of this can be maps or diagrams tattooed onto the scalps of slaves before letting the hair grow back, concealing any evidence of the map or diagram from security on borders. In digital processes it is possible to utilise steganographic methods to hide one signal within the noise of another. By altering the least significant bit (LSB) (Fig. 69) of an 8-bit string in a JPEG, for example, no significant alterations will be visible within the JPEG - it will still look the same. It is then possible to use the noise signal of a photo to contain other information. This exploration of switching bits but still remaining as a byte of information returns to the earlier discourse of the sonic noise processes of Yasunao Tone and his physical wounding of CDs. In his conversation with Christian Marclay, documented in *Noise Matters* (Hainge, 2013), Tone specifically discusses the intentional switching of bits

through interfering with the laser reading the surface of the CD. Although Tone is not using this process to decode hidden information he is revealing a new sonic potential of what is on the disc, as he states, 'You know bytes and bits, right? One byte contains sixteen bits of information. So, if I block one or two bits, information still exists - one byte of information - but the numbers are altered so it becomes totally different information.' (Tone, cited in Hainge, 2013, p.132) Sonic information is always in a state of becoming, with the potential to be noisily realised through processes of hacking and appropriating that which contains the information in a method that refers back to the OOO position that objects (in this case sound) contain volcanic powers that can erupt into action unexpectedly (Bryant, 2011). Nicolas Collins takes this concept a bit further through his appropriating of the CD player itself as a method to unearth hidden information within the data of a compact disc. Collins opened up the playing device and focused on the way that it handled the information that it read from a disc. By disabling the mute pin on the circuit of the player Collins created a machine that was never quiet.

'With this pin no longer in place, the CD player reads all the information as audio, it is never quiet as it moves across the disc, reading and playing information such as the track numbers and track lengths as audio. Even while in pause mode it is still reading the information that keeps it in place. It would also play all the error-correction data and the noise usually muted by the correction software when covering for lost data.' (Kelly, 2009, pp. 249-250)

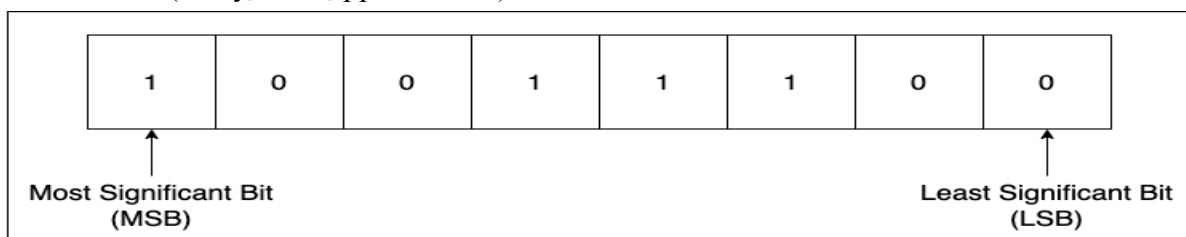

(Fig. 69 An 8-bit string identifying both the Most and the Least significant bit)

The CD player, again after shifting into the mode of production, is positioned as noise making machine from a very slight modification to its internal circuit, however, it is not the machine itself that is opened up as the data and information was always being received by the machine, instead, we, the listener, are opened up to an experience of unearthed hidden information being played back as sound. The information was always there on the discs, silently (for humans) operating with the machine and Collins has simply made that part of the new listening experience. This is an opening up of non-human experiences to humans - alien phenomenology in action that equally follows Cage's concept of *panaurality* as discussed previously.

Thus, the creative use of noise in sound performance can be to produce both particular sonic effects and also as specific covert methods of signal transmission. Within performances of *transmission+interference* hidden signals are fed-back into the system of LED generated sounds in a way that becomes unknown to the performers (an LED modulated by another sound source will appear as just an LED to the eye) as signal from certain machines are used as signals to modulate an LED Transmitter. The layers of sound are hidden from the performer, only to be unearthed through the presence of a receiver that is able to decode that signal - a solar cell. There is a playfulness to this use of secret, hidden signals in the performances creating surprising events of sounds. In one example, the image of a performers face (Fig. 70) was translated into sound and transmitted within the machines of *transmission+interference*. This image-as-sound was unknown to the audience, it was never projected or made visible in any way but instead was a noisy

feature of the sounds generated - a hidden object (image) within a hidden object (sound) within a LED light signal (object).



(Fig. 70. Capture of Strang's face having been processed as sound and transmitted in light.)

‘Territorialization is an act of rhythm that has become expressive.’ (Deleuze and Guattari, 1987, p. 348)

The movement of noise and signal across territories is suggestive of particular speeds, motions and direction that are also features of the final section of this chapter, dust - they are nomadic. The electromagnetic spillage within *transmission+interference* has no intended direction and indeed works across the spaces of the devices encountering objects of attraction and repulsion which, in turn, produce results of altering speed, motion and direction. The signal, like dust, is migratory and the points it passes through are regardless of where it has come from. Dust forms entirely from objects of various territories assembling in multiple

places and as the collective assemblage of dust it performs in the same manner of movement. When it is not marking the topology of surface, dust is travelling across and over territories, mixing more and more particles to the power of its assemblage. It is not travelling with an intended destination and it does separate itself from the materials of the space that it inhabits - dust not only is made of the space it is in but it makes the space much like the noise of *transmission+interference* is made by the devices whilst it also makes the devices. 'The nomads inhabit these places; they remain in them, and they themselves make them grow, for it has been established that the nomads make the desert no less than they are made by it.' (Deleuze and Guattari, 1987, p. 421)

Nomadic movement encounters assemblages, rhizome, resonance, objects and the in-between. They are either moving nomadically or construct space (surface, points or lines) within which other objects are able to move nomadically. When discussing the travelling laser points of Robert Henke's *Fragile Territories* or the movement of heat across the space of *Light Entropy* or the transmission of a hidden audio signal in *transmission+interference* there are only ever intended movements between points 'A' and 'B' but in the in-between there is nomadic potential:

'But dust is a real nomadic entity.' (Negarestani, 2008, p. 88)

3.5 Dust

Keywords: Dust, Dirt, Interference, Speculative

‘If dust rises high and sharp, vehicles are coming; if it is low and wide, foot soldiers are coming. Scattered wisps of smoke indicate woodcutters. Relatively small amounts of dust coming and going indicate setting up camp.’ (Sun Tzu, cited in Amato, 2001, p.15)

It is useful to end this chapter by returning to the core material hyperobject from the previous chapter before moving on to discuss the making processes of workshops. Dust acts to envelop the world of objects in noise, it is observed as noisy hyperobject itself and it displays the properties of noise previously discussed here in this chapter that are of central concern to *transmission+interference*. Dust operates as both material and, seemingly, immaterial, it hides or covers as well as reveals and carries information, and it territorialises space whilst being ‘not quite of the ground, not quite the atmosphere.’ (Parikka, 2015, p. 85)

Throughout sections of the previous discourse around noise the CD and CD player have featured as machines of interest to certain noise makers operating within a Post-Digital practice. These technologies, again, offer an interesting beginning point for exploring the noisy object of dust as the unique selling point of the CD was the crisp, clean sound operating from within a closed off environment of the CD player. No longer would materials affect the playback by gathering on the surface (vinyl) or embedding within the medium’s housing (cassette tape) - the CD player offered a way to avoid the noisiest household material: dust. Tone’s treatment of the CD surface directly confronted this comfort of the safe, digital material and broke down

the barriers between the noisy outside world of dust and other materials and the inner workings of the CD that lay hidden from sight and touch. Dust was re-introduced to the surface of media playback and it brought noise along with it (Parikka, 2015). Following a line of discourse from Maturana and Varela through to Levi Bryant, the machines of *transmission+interference* are structurally open to the world around them and, whilst this does not mean they are able to experience or be influenced by everything in the world they are most certainly capable of being affected by dust. Surfaces feature as a core object in the work, particularly of the solar cell which is largely made of surface, its manufactured intention is to be a surface for light signals, sound is produced by how patterns of light hit that surface. If this surface is covered in layers of dust then it structurally interferes with the operation of the solar cell object.

The development of a *Dust Series* of machines in *transmission+interference* was arrived at later in the research once larger, more dominant objects (e.g. computer fans) and processes (e.g. reflecting lights signals) had been explored but dust had always been there, it just needed to be encouraged as a new object of noise. Dust was materially explored initially at a postgraduate workshop at Jiangnan University, Wuxi, China, and then at ISEA 2019 in Gwangju, South Korea. Dust works as the disrupter of information in the CD player becoming a noisy reading of bytes in the form of audio that is reflected in the sound works of artist and turntablist Christian Marclay. With his vinyl record release of *Record Without a Cover* (1985) Marclay actively engaged with dust as a sound generating object in order to rupture the listening experience of a record release. The record came with instructions for the

owner to leave the vinyl record (that came with no protective sleeve) lying about between playing it so as to encourage dust to assemble with the grooves of the record. This challenging experience for many audiophiles, who would usually be very protective of, in particular, the surface of a record so as to avoid dust, scratches or any other form of noise making effectively brought dust into the sound making world framing a sonic assemblage along with vinyl surface, grooves, record stylus, and the recorded sound. The dust was a new sonic experience each time the record was played, new rhythms were created by the needle sticking or jumping and new qualities of sound were generated as dust interfered with the clarity of information from (sound) picked up from the grooves in the vinyl surface causing the sound to become muffled. Marclay explored this sonic experience of dust with analog technology at the same time as Tone explored it with digital technologies - dust does not seek to only affect certain technologies, it will cover all:

‘No matter how desperately you fight against it, Dust pervades everything’ (Marder, 2016, p.xi)

However, within *transmission+interference* the use of sound playing media (CD, vinyl etc) is not a central concern, meaning that dust was to be engaged with in the way that it interfered with light signals to create sound. In order to develop noise machines that actively engage with dust the attention of the project’s research shifted to cinematic practices in the purest sense as well as artists working directly with light. Dust was subtly building up in the corners of the research and became an obvious object of interference from simply noticing dust particles moving within beams of sunlight. In 1965, Nam June Paik had explored this concept of dust as a noise in image projection, operating with the materiality of dust in much the same

way as Marclay would do, sonically, 20 years later. By projecting a clear loop of celluloid film, with no image or sound recorded on the surface, Paik was able to purely experience the chaotic collection of dust on the surface of the film. The pure white light of the projector projecting the shadows of dust onto the wall across the space. This work is about surface, the place where dust settles and gathers. Dust brings the surface object into the machinic assemblage through, what Raymond Ruyer would describe as *absolute surface* (Grosz, 2018) (to be developed further in Chapter 4 on workshops). The noisy image is in constant flux as the machinic assemblage shifts and re-orders the patterned throw of light through mechanical rumblings, vibrating and shaking dust on the celluloid surface, and through the heat of the projector bulb affecting the surface tension of the celluloid and the air flow around the machine carrying the dust. Noisy dust particles become the new information of the newly projected image. This approach to pure light can be seen to be developed further in 1973 by Anthony McCall in his installation work *Line Describing a Cone* where McCall actively brings into the cinematic image the space in-between the projector (transmitter) and the screen (receiver). McCall described the work as a 'solid light film' (McCall, cited in Kahn, 2013, p. 213) as a single white outline of a circle is slowly drawn, beginning with a single dot and moving slowly around until the circle is completed. This circle is not only drawn on the wall (to use the term 'screen' here would misunderstand where the light is received) opposite the projector but is drawn throughout the space of the projected light as McCall fills the space with a fine haze, which, when the circle is finally completed displays not a circle but a 3D cone of light beginning at the projector and stretching out across the space to the opposite wall. The white line of the circle is drawn onto celluloid film

and over time this film has aged, been scratched, and collected dust on its surface resulting in a dynamic image as '[w]hen dirt and other artefacts disrupt the passage of light through the film and lens, black packets shoot through the "surface" of the cone.' (Kahn, 2013, p.214) The dirt and dust, whose image flies through the space, create a new image by accident for McCall, a new image that is never repeated as the collection of dust on the film is never in the same order. The intended, smooth drawing of a simple, pure white line has become a noisy film demonstrating the transmission of light and shadow. These works dynamically describe the image of dust and dirt as a material of great interest that offers much to the artistic practice of cinema and projected light. In fact, light artist James Turrell comments that when viewing slides of art history 'he found himself staring at the light shining through the air illuminating particles of dust and finding the beam more interesting than the image on the screen.' (Ibid) Dust and light are inseparable.

To develop *transmission+interference* machines that played with dust in light to create sound there is a direct inspiration from the *Laser Payback Head* (previously mentioned in Chapter 2) developed by Martin Howse. A machine that noisily plays surfaces but is only capable of producing sounds through encountering the difference on the surface. It reads and playback the dust, the cracks, the physical artefacts of the surface over which it is drawn. This laser light and solar cell setup was utilised in *transmission+interference* positioned across the surface of a vibrating machine (EBDM, for example) that was responding to signals and feedback, as described earlier, in order to build up waves of resonance that would shake the machine. The resonance would make a field of dust and dirt particles

gathered on the surface dance and jump, interrupting with the laser light signal shining across the surface of the machine producing the difference in light received by the solar cell that is then understood as audio signal. Instead of searching the surface for difference (as with Howse's machine) here the transmission system is left open for the interference to take place. The smooth light of a laser signal ruptured by the dirt and dust mirroring the disruption of light signal in McCall's installation. The tiny breaks in signal when dust particles interfere with the light are of a scale large enough to create a voltage dip and rise from the solar cell, which is the sound we hear. This follows from early experiments in interfering with laser light signal in *transmission+interference* when laser light was passed through a clear bottle of water which then had an effervescent tablet added to it. With the laser on one side and the solar cell on the other, the break in laser light signal caused by the tiny bubbles produced in the water were enough to create a sound very close to white noise. These bubbles were surprisingly productive in making sound and led to this exploration of the smaller material of dust.



(Fig.71 dustCrackler (for Hess))

Dust offers a further approach to making noise in a more natural way by just letting dust do what it does best, gather and cover surfaces. In homage to the artist and physicist Felix Hess the machine *dustCrackler (for Hess)* (2019) (Fig. 71) was developed taking inspiration from his *cracklers* machines, which consisted of small electronic circuits that produced tiny clicks (or crackles) according to changes in air pressure measured with a simple microphone. The tiny clicks were amplified through an speaker assemblage of balsa wood, stone and piezo disc (fixed between the wood and stone) that would be left running 24 hours a day in Hess' house. The

ambient clicks (produced from a number of *cracklers*) became a part of the rhythm of the day. The *dustCrackler (for Hess)* sits similarly in my apartment consisting of a small electronic circuit that produces oscillator tones. The circuit is powered by a small solar cell and over time, as dust and dirt gather on the surface of the solar cell, the power of the circuit is altered. Dust is used here to create new sound not as a direct sound signal by causing jumps in analog voltage but instead by altering the voltage across the entire circuit. It is also not played by a human performer but instead sits and continues to try and run when enough light breaks through the dust to hit the surface of the solar cell for powering the circuit.

It is clear that dust and dirt are able to interfere and break light signal (see Turrell's fascination with the dust in a projector beam of light mentioned earlier) but there is also the material make up of dust that offers potential in a speculative sense to the making of sound. For the *Dust Series* of machines in *transmission+interference*, the process of making *with* dust, sympoietically (Haraway, 2016), offers a new way of exploring a material's potential as it seeks to cover, spread, and connect. In the development of *Dust Circuit* (Fig. 72) the ability for dust to combine with and carry is investigated through the building of small oscillator circuits where the physical connections between components (resistors, IC, capacitors) are left disconnected, with a space in-between where there would usually be a direct, physical connection either soldered or prototyped on a breadboard. These circuits are left to gather dust across all the components and in-between them questioning whether dust, made up from all decaying material including those that are conductive, can potentially complete the connections between components and carry signal through its

assemblage of materials. Dust acts as a potential solder that, one day, should cause the circuit to function. In a similar approach, the *dust circuit* is built with all but one component fully connected. Dust is encouraged to fall, gather, and become the missing component of a resistor. Dust becomes the object of noise with which to make noise. This approach was inspired from the discourse around the architectural project *Dusty Relief* (2002) mentioned in Timothy Morton's book *Hyperobjects* (2013) where the architectural firm R&Sie designed an electrostatic building in order to attract dirt and dust to its surfaces to form a dusty coating around the building as opposed to attempting to control and sweep away dust. As mentioned earlier, these dusty circuits operate speculatively with objects to suggest potential new ways of making noise and this connects to the practice of John Richards and his paper *Speculative Sound Circuits* (2018) that links Cage's interest in the vibrational qualities of physical objects, through Garnet Hertz's *critical making* (2012) processes with the design-based methodologies of speculative design in order to suggest new potential sound making machines. It is entirely possible that a *dust circuit* waiting for dust to complete connections may never produce sound but it is in that space of setting up a surface of potential that critical, speculative questions are born that are focused more on 'why?' rather than 'what?' (Richards, 2018). This concluding section to this chapter links the operations of dust circuits with the discourse of objects from Chapter 2 where a *dust circuit* is not operating in order to answer any sonic questions but only to critically posit new investigations of objects and their relations. This discourse brings in another type of object (extending beyond Bryant's six object types) from Michel Serres, the *quasi object* (2007), that is discussed by Brian Massumi in relation to potential as 'part-subject' (2002, p. 71).

Whilst the discourse coming from Serres and Massumi relates to the affective power of movement from a soccer ball in relation to the players, ground, and goals, it sets up a field of play that is reflected in the field of operations across an electronic circuit with its signal being passed from component to component. A speculative circuit (Richards, 2018) that actively utilises dust as a component to make-with is a field where signal is moved and interrupted by the components and their relations whilst setting up potential outcomes. Massumi states that the field 'is more fundamentally a field of potential than substantial thing, or object' (2002, p. 72) but, through following Bryant, that field of potential is a machine in itself - it operates to produce new machines through its assemblage of objects. A *dust circuit* could then be said to be charged with potential - it has its field set out across a breadboard or prototype board with objects and their relations, and the settling of dust across the surfaces and connections charges the field of play with potential new machinic becomings. In agreement with Massumi, as he follows Pierre Lévy's discourse on individual and collectivity, the *dust circuit* moves 'toward[s] a notion of collective individuation around a catalyzing point.' (Massumi, 2002, p. 71) The collective individuation is the emergence of new machines that are in constant flux as their assemblage continually reforms around dust (the catalyzing point).

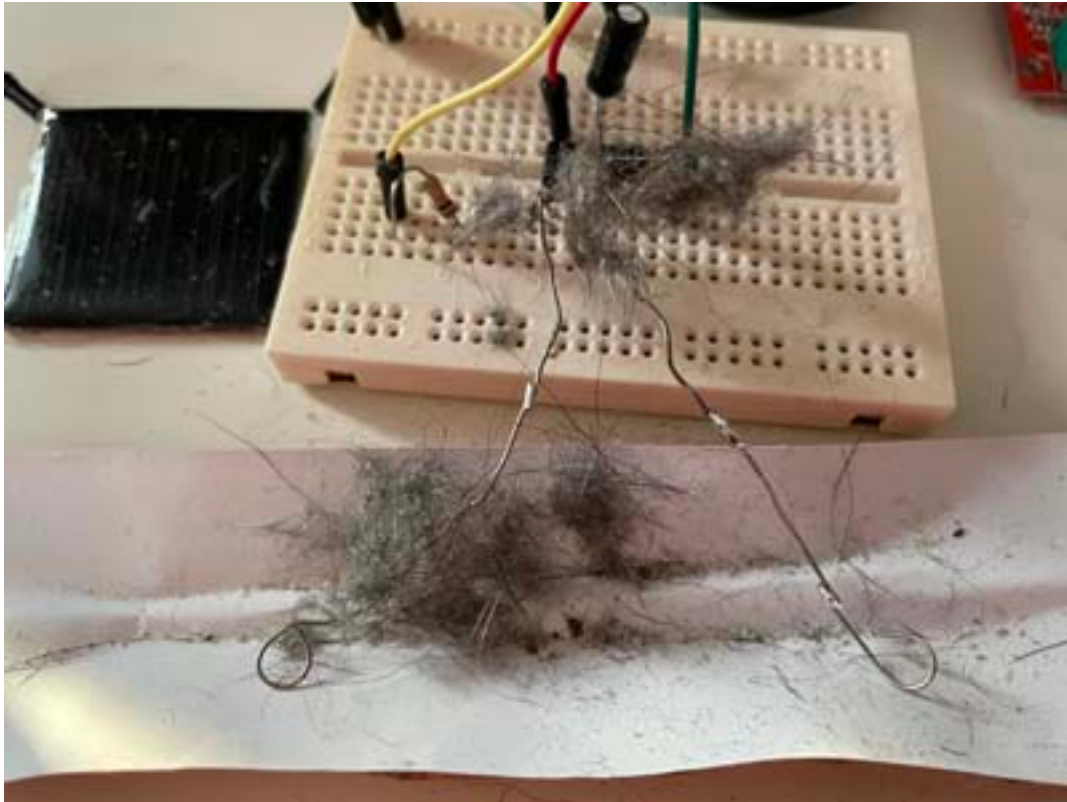

(Fig. 72 Dust Circuit. An oscillator circuit with feedback resistor left open with two wires)

Dust acts to query the potential of noise making from an assemblage of objects whilst operating as an object of interference and (potential) connection within the assemblage. This positions dust in a speculative circuit as a speculative (hyper)object - it has ontologically flattened the field of the circuit and human performer. As Richards states, '[t]he performer no longer remains at the centre in a human-machine interaction, but enters a new speculative relationship.' (2018)

3.6 Conclusion: Noise

This chapter has introduced the various creative possibilities available when opening up to noise. Noise has been introduced as an essential aspect of the development of sonic arts, opening up the world as an audience to new sounds. How the sounds are achieved though is of importance here just as much as what those sounds do. The chapter has demonstrated that there is a rich history within sonic arts and music that has learnt to engage with noise in regards to its audible qualities as well as how it can be used for creating those qualities. In a continuation from the vitality and energetic flows coming from objects and machines in Chapter 2, energies of sound, light, and information are experienced to be flowing throughout the discourse of this entire chapter.

Through Yasunao Tone and Nicolas Collins the chapter has shown the connection between a hands-on hacking and appropriating of media machines to release the hidden powers of those machines for humans to appreciate new potential. Much of this was developed from the important ground work laid out by John Cage and the ruptures that his new methodologies caused to the world of music, providing a link back to the introductory text outlining the context of the practice of *transmission+interference* at the beginning of this thesis where Cage's *Future of Music: Credo* was introduced. Within the discourse that mixed multiple sonic arts practitioners and *transmission+interference* there is a clear link between the noisy sonic outputs in performances and the noisy methods of making through an opening up of machines to new flows of information and affect. When Blamey layers

spools of copper wire mess over bare circuit boards or Nicolas Collins removes a mute pin from a CD player they are each opening up the structural flows of those machines (through a noisy interaction with objects) to enable a whole new world of sound and noise to spill out - the hidden powers of noise are released through these acts of appropriation. However, noise is not confined to the sonic world or those worlds of only operating with sonic machines as the chapter explores the potential of information in noise through Shannon and Weaver's mathematical theory of communication and practices of hiding information through steganography. The influence of Shannon and Weaver's work is communicated within *transmission+interference: digital synesthesia* to further reveal uncertainties within the world of information transmission that offer a potential re-visiting. To now view this mathematical theory with the lens of OOO, MOO, and new materialism suggests that the vitality of the system is perhaps not fully expressed and could therefore be adapted to engage in a more ontologically flattened way - this will be picked up again in the final synthesis section. The approach to thinking of sound and information as operating within and across territories is a thread that is initially picked up from information theory.

As *transmission+interference* also engages in practices of light for the means of creating sound certain cinematic (or pure cinema) practices are too opened up to and by noise revealing a multidimensional space (territory) of interactions that is revealed, in many ways, through the hyperobject of dust. Light brings the black noise of dust at the fringes of attention (Harman) into actual view for humans, dust is revealed in the sun beams that Alexander Graham Bell was trying to listen to, or

in the light beams that were carrying images of art history (James Turrell), but also dust is seen to reveal the surfaces of celluloid film (Paik, McCall). A shift takes place for dust as not only something that smothers and covers objects and machines but is it self exposed as a revealer of new information, revealing the hidden powers of surface, light, sound, and object / machine, as Clarice Lispector puts so poetically:

‘She missed the roses, They had left an empty space inside her. Remove an object from a clean table and by the cleaner patch that remains you see that there was dust all around it. The roses had left a patch without dust and without sleep inside her.’ (Clarice Lispector, cited in Marder, 2016, p. 95)

Chapter 4: Workshops

4.1 Introduction

Keywords: Assemblage, Making, Territories, DIWO, Interaction, Intra-action

The aim of this chapter is to explore the territory where objects, things, machines, and noise merge together through the activities of practical workshops. This territory of the social exchange of ideas, knowledge, and practical skills is constructed for the specific purposes of interaction between participants and each other as well as with the materials of focus in the workshop. The workshop as a creative space has developed over time since the instructional method of the 'expert' (Sennett) delivering instructions to the apprentice and within this chapter the focus is on how the old hierarchal delivery of knowledge and expertise can be ontologically flattened to enable certain interactions to occur in a more chaotic space of making where new (unexpected) knowledge is produced together.

Observed throughout this chapter is the rich entanglement between humans and non-humans in an extension of post-humanist discourse through Object-Oriented Ontology (OOO) and New Materialism where this now ontologically flat territory of making actively moves beyond the limitations of Do It Yourself (DIY) practices to engage in the more open and collaborative practice of Doing It With Others (DIWO).

This chapter will explore the application of the workshop from within the *transmission+interference* project whilst also exploring its creative use by other practitioners such as John Richards. These practices and practitioners offer the framing of where humans and non-humans interact and intra-act and therefore enable a discourse where OOO and New Materialism mix with anthropological

studies of making (Ingold). The aim here is to now fold together the previous discourse around objects, things, materials, and noise in order to understand the creative potential that emerges when artists intentionally open up the making process to diverse fields of knowledge coming from various human participants across a range of creative disciplines and the fields of energy that flow throughout the objects and their relations.

The chapter will begin by introducing the workshop in a traditional setting in order to understand how contemporary maker practices have built upon this model. From this point the full complexity of the research begins to be explored through a mapping of object, noise, and machine through a discourse led by Deleuze and Guattari's concepts of assemblages, the refrain, the rhizome, territorialisation and de-territorialisation, and nomadism. It is through these key concepts that related theory from OOO and New Materialism emerges. The *transmission+interference* workshop is the site where previous discourse of assemblage, repetition, rhythm, resonance, relations and the in-between form territories with objects and noise.

4.2 The Workshop

Keywords: Hand, Network, Difference, Open to

The workshop is of great importance in this thesis as it is the territory of action for all that emerges as noise, performance, art installation, text, and machines in the *transmission+interference* project. To follow the line of thought regarding nomadism coming from Deleuze and Guattari it is possible to state that the workshop makes *transmission+interference* and the workshop is *transmission+interference*. All the machines hacked, appropriated, and developed for performances and installation have become so through the workshop. These machines make *transmission+interference* through their produce of noise (sound, object, information, and light) and the workshop functions similarly through noise in order to develop these machines. The workshop is the first *transmission+interference* machine.

To begin exploring the workshop and how it functions within *transmission+interference* it is important to understand where this practice has emerged from and unpack what are the core units of a workshop. The workshop can cross disciplines and be inter-disciplinary in itself. It operates across these disciplines (arts, sciences, humanities etc) to serve new knowledge as much within creative writing as in pottery or creative coding or cooking or sewing. The human is brought into contact with the media of choice where both thought and action are required to develop an outcome that may either be set as a desired goal or left open for any eventualities that may emerge. An encountering of knowledge, skill, the

hand, and the technical object are required for the workshop to function. Within the context of sonic arts practices it is of interest to see how conference open calls (take ISEA or NIME for example) actively engage in the practice of workshops placing them alongside open calls for papers, artworks, and performances. In the academic fields of contemporary media arts it is encouraging that there is an active development of the various forms of telling and sharing that reach beyond the text. *Transmission+interference* workshops have, themselves, been developed through workshops at academic conferences such as ISEA and ISSTA.

The workshop as is understood today has developed from one of the oldest forms of social / community making that can be traced back to ancient China and Greece (Sennett, 2012). Over time, the practice of the workshop has developed specific characteristics and attributes that serve to make it an effective process of learning, teaching, making, and sharing. Before the introduction of large scale mechanical factory working processes in the 19th Century, leading to the development of Fordist production lines of repetition, the workshop had developed as a space of interactivity, playfulness, and inventiveness across networks that were, in places, self-governing. These key tenets of the early workshop, as outlined by Richard Sennett (2012), still resonate within current workshops and it is these aspects that serve to constantly keep the practice of workshops alive in the face of ever growing capitalist models of production. The effect of a de-skilled community, struggling in

the face of an ever more complex world of technology (Bridle, 2018)⁷ has meant a revival of the workshop in fields of technology based arts practices, such as sonic arts. This can also be understood as a concern of the post-digital condition producing a desire to re-connect with making processes in direct contact with the hand in opposition of the (cold) distance created in digital production methods of screen and mouse cursor. This re-connection operates as a process of opening up the act of making through actively involving the inclusion of noise, in the form of physical dirt and dust (as well as sound, light, and information), in order to make *with* the noise (Kelly, 2021).

In Sennett's book *Together: The Rituals, Pleasures & Politics of Cooperation* (2012) he presents an early development of workshops, just after the American Civil War, through the story of ex-slave Booker T. Washington, who developed a project in order to shape the technical skills of African Americans recovering from slavery. Washington aimed to achieve this through the practice of the workshop at the time that would be delivered through institutes where participants would live and work together before returning to their separate communities to then impart these newly learnt skills and knowledge to others. Here, there is an instance of the network of information that flows across a workshop but is not limited to the workshop's environment or space. The workshop does not end - the skills of carpentry or metal working continue to be developed and spread amongst the community of workers.

7. In *New Dark Age* (2018) Bridle argues that with the ever-growing emergence of computational technology into the structures of everyday life the more removed we become from not just acting and doing things but from simply understanding how things work.

This is the shaping of a diverse and ever changing / growing territory of knowledge and skill sharing that introduces core units of the workshop including time and duration (and these involve rhythm) across networks of information that have the potential to be self-governing (reflecting earlier discourse on autopoiesis where organisms present the ability to self generate paths of development which will be returned to later in this chapter) - Washington observed that labourers openly discussed their work with each other without the presence of a workshop leader (Sennett, 2012). The workshop was becoming an open space for all to learn and instruct, learners switching into roles of instructing and then back into learners again. What enabled this mode of practice to be developed was the realisation that the materials at hand were expressive themselves and helped to develop a show don't tell model of sharing knowledge and skills. The labourers were always working directly with physical materials and objects and it was the manipulation of those things that contained and disseminated the knowledge in ways that also achieved a breaking down of gender stereotypical boundaries. Men were involved in the (then) traditionally female field of sewing entirely through working with the machines required for sewing - the entanglement of object, machine, and human becoming one machine in itself. A shared space was being developed through 'the artisanal workshop [...] as a rebuke to the factory' (Sennett, 2012, p.57) and one key unit of that shared space that is of particular interest to this thesis (expressed across chapters 2 and 3) is that it involved and accepted difference as apposed to the imposing of homogenous forms of one-ness desired within the factory model. The goals of these early artisanal workshops were often to follow a task to completion (make a chair, for example) but allowed for individual thought and skill in ways to

develop and improve the final product. This allowance for difference follows what Bakhtin describes as 'dialogic' conversations where 'a discussion does not resolve itself by finding common ground' (Sennett, 2012, p.19). These early workshop environments setup by Washington helped to realise the strength in difference as a producer of new knowledge. It should be noted that there is a distinct difference between the skills developed by labourers in one of Washington's workshops and those developed within a *transmission+interference* workshop which is based on artistic practice. The labourers were always focused on specific goals, to make a specific object (with individual thought and skills, though, as mentioned above), whereas in *transmission+interference* participants (not labourers) are encouraged to express their individual skills and thought through a making practice that could yield very unexpected results - there is simple goal of creating sound with objects but that sound is not planned and the types of objects used to create it can be anything available to hand. This idea of using 'anything to hand' will be developed further in the following section 4.3 Fields, Worlds, and Territories.

One final point relating to the workshops within the Institutes created by Washington that is worthy of note is the photographic documentation of the workshops done by Frances Johnston as these serve to show the differences and the objects as they plainly occurred at the time. Images show 'ex-slaves and dispossessed Indians working together in greenhouses and in carpentry shops [...] doing demanding things together' (Sennett, 2012, pp.61-61). Differences being encouraged to mix for greater diversity for the good of the newly emerging knowledge and skills. Sennett also keenly identifies Johnston's skill with the

camera's depth of field (a very unique skill in the late 19th Century) in order to flatten the space of the humans and the workshop tools (objects) so as to reduce the hierarchical structure of human in control of object and present a more level viewing of both human and object working together. Throughout history newly emerging technological objects are often introduced with a fear of them replacing the human (see printing press or AI) but 'Johnston does not present tools as alienating; she makes them as visually important as the people using and sharing them.' (Sennett, 2012, p.61)

The inventiveness and playful creativity that has become part of the workshop practices emerged out of the workshop environments developed at the turn of 19th Century by Charles Fourier. The buildings created for Fourier workshops or *phalansteries* (Sennett, 2012) were designed in such a way so as to encourage chance meetings between humans and objects through an environment where all participants were housed together and would meet each other throughout the day and evening, not just in 'the workshop'. This is an early encounter with the practice of Doing It With Others (DIWO), as opposed to DIY, that will feature as the final section of this chapter. Here, Fourier began to imagine the building as the workshop space, not only the dedicated workshop rooms as participants would be able to discuss and share their work and skills continuously. Whilst this continuous engagement is something of interest and has since shifted into online spaces between contemporary workshops it can present issues of participants unable to simply switch off from the work required, becoming fatigued by the process. The most important development from Fourier was how he introduced points of noise

throughout his buildings in the form of boxes of toys that were made available to workers in an effort to encourage play between them and objects so as to realise potentially new methods of completing tasks. It is important to note that the workers here were engaged in completing rigorously defined tasks that were strictly handed down to them from workshop masters, so the play was only related to completing fixed tasks not to encourage complete freedom in making anything (Sennett, 2012). This radical approach helped to define ways that playful interaction, between humans and humans, and humans and non-human objects, would benefit the making process and is now an important aspect of creative workshops within the arts that is expanded through the discourse of Barad's *intra-action* (2007). In the workshops of *transmission+interference* participants engage in exploring a variety of objects for making sound that are provided for the workshop (integrated circuits, motors, fans, LEDs, etc) but are not shown how they must be assembled for a specific outcome. Instead, they are encouraged to try things out to see what emerges from objects when they play with and are also encouraged to bring along any machines they think might be interesting to explore in relation to sound and light. An example of a hack of a cassette tape player (Fig. 73) to explore the motors and physical vibration of the device (rather than its ability for playing cassette tapes) demonstrates how this unknown path of playful engagement can yield exciting and unknown sounds. This hack made beautiful squeaking sounds when a tiny mirror was attached to moving parts of the cassette player and a laser was pointed at the mirror - the resulting squeaks coming from the reflected light hitting the surface of a solar cell. The sound and light machine that emerged from this play with objects could have ended with no sound, or sound that is not interesting to the ear but that

is not a concern in the moment of playing with the objects in unconventional ways - the participant becomes focused on an exploration of the object and its interactions.



(Fig. 73 Laser light reflecting from a hacked cassette tape player)

The model of the top-down workshop, where information and knowledge are passed down from a workshop master to an apprentice who then follows the instructions, is an overbearing method that features so strongly in tuition that it is difficult to break away from. The early workshops of *transmission+interference* began with this approach of delivering a fixed set of instructions to be followed precisely; in fact, they needed to be followed so precisely as the only parts provided for making were those ones detailed on the instructions. There was not even the material capacity to explore other options - each participant had their set of LED, audio transformer, solar cell, audio connections, and cable to complete the set task.

Workshops were set for a short period of time (a couple of hours), participants would make the *LED transmitter*, test it worked, and then leave with what they had built. In this mode of practice the workshop serves to impart very specific knowledge about constructing a machine, most early issues discussed in these workshops centred on the basics of an ability to solder (just a technical task) but did not open up further to discussion about the potential use of the machine creatively. This detail demonstrates a few things: firstly, that those delivering the workshop (Strang and Van Uffelen) had a limited idea of what to do with the machine itself and thus, secondly, the structure of master and apprentice(s) enabled a level of control to be held by the 'masters'. When Sennett discusses the master / apprentice setup he often refers to the world of music, where playing techniques are instructed and copied as well as the technical workshop where instruments are built, for example, where he discusses Stradivari's workshop (Sennett, 2008). The field of music offers a method to deal with many elements of the workshop such as, rehearsal and instruction, and is an example of where the show don't tell method is very effective in imparting knowledge. However, one area of influence upon music where Sennett does not explore is that of 'the open work' as detailed by Umberto Eco (1959) even though Sennett does expressly mention an 'opening up' process developed within workshops. This discourse returns us to thoughts around the sonic arts practice of circuit bending, mentioned in the previous chapter on noise, as a method for opening up physical technologies to yield new sonic experiences. Whilst Eco is focused on tackling compositional and performance processes within specific case studies (Stockhausen, Boulez, for example) his essay is a valuable text to further understand the workshop through. Eco's statement that '[t]he closed, single

conception in a work by a medieval artist reflected the conception of the cosmos as a hierarchy of fixed, preordained orders. The work as a pedagogical vehicle' (Eco, 2006, pp.169-170) resonates with Sennett's details of the Guild house and master / apprentice relationships in early workshops (Sennett, 2008). Eco introduces a number of phrases as he outlines the strength of the 'open work', that results from 'new scientific awareness' (ibid), as a process for developing new creativity and unexpected results. Of interest here are terms developed from the composer Henri Pousseur, 'work in movement' and 'field of possibilities' that both resonate with discourse from Chapter 2 of this thesis on the potential power of objects. The 'work in movement' introduces the concept of working with an unfinished body of work - for Pousseur, the completion of the piece occurs in collaboration between performer and composer and is a useful method for opening up the workshop to new potential. To begin lessening the hierarchy between master / apprentice relationships the 'work in movement' process expresses the need for the development of dialogue between the two, a dialogue of difference, coming from Bakhtin's 'dialogic', that will yield surprising results for both parties in the exchange. The second phrase, 'field of possibilities', suggests a dynamic, vibrant system influenced by physics, where fields are a 'complex interplay of motive forces' (ibid), and the philosophical notion of possibilities offering unknown potential as a result of activity within the 'field' - an offering of hidden powers. The workshops of *transmission+interference* began with the classic pedagogical delivery method, with a strict hierarchy, and then actively shifted into an 'open work' specifically due to the realisation that nothing of creative interest was being developed out of the workshops, even though the machine being made was creatively stimulating. To

make this shift from a hierarchical mode to an open mode of workshop processes requires a return to the practice of alien phenomenology (Bogost, 2012) from Chapter 2. Through an understanding that the workshop is a machine, like any other technological or social assemblage, that has interactions within and without itself alien phenomenology prompts that we interact with these interactions to fully understand how they interact with the world that is around it. The workshop structure can be ontologically flattened in order to present other interactions that potentially exist within it - there are more interactions available than just presenting step-by-step instructions to follow. Alien phenomenology suggests that it is possible to open up the lived experience of the workshop - what are the ways in which the workshop encounters the world? Within the context of workshops, it is important to note that the practice of alien phenomenology is itself influenced from what systems theorist Niklas Luhmann calls 'second order observation' (2002) and what biologist Jakob von Uexküll calls 'ethology' (2010) - each seeking to explore how other entities interact with the world. Throughout a workshop machine there exist flows and operations that are open to influence and capable of influencing other units of the workshop and that by understanding these flows, realising their creative potential, the workshop can shift from one direction of information delivery into a state of a more openly fluid rhizomatic assemblage. The flat, openness of the workshop, inspired here by Eco, Pousseur, and Bryant, that is thus able to move in many directions according to its forces relates to Nietzsche's concept of *Will to Power* that deals with directions and orientations of forces within the collective, not individual, experience. As Elizabeth Grosz states, 'will is the direction of a force; power is the quantum of force, the amount of energy it can expend or attract. The

will to power is what expresses the *inner* force of each thing' (2018, p. 111). All the objects in the workshop are a 'thing' and so too is the object of the workshop, the workshop in *transmission+interference* is a sonic arts space, a space of artistic expression where objects are moved by the inner forces of other objects. The creative workshop 'enable[s] us to feel these forces and to be enhanced by them bodily.' (ibid, p. 113)

For this opening up to occur one final unit needs to be addressed: control. As detailed within the previous chapter on noise, control is a fundamental unit to understand in relation to how it can enable new knowledge to emerge. Control comes with limits and degrees of power. The early *transmission+interference* workshops developed a tight control over information and creativity through a limitation of individual knowledge and skill. To tightly control the workshop environment meant a delivery of information in one direction, to the participants, with the result of a technical build of a machine that was already well understood by the workshop leaders. This mode meant that the knowledge and skill of the workshop leaders was not tested in any way, it was a safe and comfortable mode of operating and to open the workshop up meant a reduction of this control, to open up to unknowns, as Sennett states, "[o]pen" up is intimately linked with "open to", in the sense of being open to doing things differently, to shifting from one sphere of habit to another.' (2008, p.279) Thus, through alien phenomenology the workshop machine is open to new flows and operations that challenge the control of the workshop leaders in a creative way to enable the emergence of new knowledge, new skills, new sound, and new noise. Alien phenomenology in this instance is an

act of deterritorialisation of a workshop in its state of becoming and, to follow this line from Deleuze and Guattari, involves a degree of improvisation, '[o]ne launches forth, hazards an improvisation. But to improvise is to join with the World, or meld with it.' (Deleuze and Guattari, 1987, pp. 343-344) The act of opening up the workshop to its flows and operations is to join with its 'World' through unknown improvisations with humans and non-humans. The workshops of John Richards based on the building, practicing, and performing of the *sudophone* (2022) clearly mark these modes of the workshop moving from one state of hierarchical control through to an open exploration of sounds and ideas. The workshop typically begins with the laying out of tools and objects required for each participant to build along with a schematic and step-by-step instructions. Each participant then follows the instructions to solder and assemble the objects of speaker, 555 timer, resistors, capacitors, metal can, and bolt to create their own *sudophone* - each one operating the same, through capacitive touch, and creating, what is initially regarded as a limited scope of sound, a square wave adjustable in frequency and amplitude. This part is completed with Richards as the master and the participants as the apprentices building his instrument as he has designed. Then Richards removes his control by asking the participants to score new performances with the *sudophone* (2022) by exploring new ways of playing the instrument - this is where Richards creates new and unexpected results from a machine that he thinks he knows, he will have heard much of the sonic output before but every so often opening the structure of the workshop to new flows and operations will produce new knowledge and skills.

The workshop practice that *transmission+interference* engages with incorporates the objects of this discourse so far but moves beyond the concept of a space for only making and repairing into a space for thinking with and through objects and materials at hand allowing for a true dialogue between all objects. This development relates to a mode of carpentry that occurs within the context of alien phenomenology that Ian Bogost has termed *philosophical carpentry* (2012) that connects the processes of traditional carpentry, through making by hand, with the philosophical discourse related to the worlds of those objects involved in the making process. As will be highlighted later through Polanyi and Ingold, philosophical carpentry allows for a move beyond text as the only possible method of detailing knowledge. It is a method for opening up the experience of objects and allowing for new exchanges that would offer new potential in the making process; ‘carpentry entails making things that explain how things make their world.’ (Bogost, 2012, p. 93) This requires a different level of attention between human and non-human objects that engages with Sennett’s concept of *material consciousness* where the craftsman (to borrow Sennett’s term) engages in a dialogue with the material at hand that avoids any divide or split between thought and action (Sennett, 2008). Sennett’s neat summation of the concept is useful when thinking about more than just making and repairing things as he states that we become engaged in material consciousness when ‘we become particularly interested in the things we can change.’ (ibid, p. 120) For the purposes of this thesis it is useful to fold into this concept from Sennett the thinking from Raymond Ruyer on *absolute surface*. Ruyer develops the concept that the craftsperson becomes so engaged in the working process with the materials at hand that ‘consciousness of self

disappears, to be replaced by the objects “in” consciousness.’ (Grosz, 2018, p. 218)

This forms an intense connection between the process of work being engaged with by hand, object, and eye. What is formed, for Ruyer, is work that is now an *absolute surface* where parts function together progressively (ibid). Through alien phenomenology this is updated to include not only how humans change objects but how things change us too and begins to create a system of feedback between objects, tools, and users that Sennett has also developed useful thought on. When a workshop participant builds an *LED transmitter* they are faced with a new machine that raises a new consciousness about the object of the LED that now operates as sound transmitter and has become what Sennett calls an *arousing tool* as it arouses creative potential and asks questions about how it should now be used (2008).

When the machine is built it simply transmits sound but we are left to engage with it in order to develop some new creative potential through processes of interfering with it’s signal and operation. This machine is also an example of one final concept from Sennett that is a necessary inclusion to the thinking around objects and making - the *domain shift* (2008). This is where tools (again, using Sennett’s terminology) that are traditionally used for one purpose can be repurposed for another or, to take this beyond the material domain, how processes applied by engaging in a certain discipline can be applied across another discipline, to activities much different from the original intention. These ways of re-thinking through tools and objects, allowing for feedback between human and non-human objects set up the the processes that move beyond just making and repairing and engage with hacking practices, where working machines might be taken apart, not as a process of learning how they function but instead as arousing tools that offer a

domain shift so as to function in new ways. This type of hacking practice continues thought around Yasunao Tone and Nicolas Collins' working processes in the previous chapter and it is within the workshop environment that we directly engage with these domain shifts where not only the physical objects shift but our consciousness around the potential of those objects shifts too.

Identified above are the key units of a workshop practice: the hand (with the body), networks, difference, objects (materials), open working processes, and active participation through interactivity between humans and objects. Whilst these remain key to the post-digital contemporary media arts based workshop that exists today there are developments in thought and action that develop these units as key lines of inquiry that will now be explored.

4.3 Fields, Worlds, and Territories

Keywords: Assemblage, Rhizome, Refrain, Sensations

‘The territory is the first assemblage, the first thing to constitute an assemblage; the assemblage is fundamentally territorial.’ (Deleuze & Guattari, 1987, p. 356)

At this stage the discourse enters into the turbulent field of (inter)activity between human and non-human entities that is central to the functionality of *transmission+interference*. The thesis so far has introduced that there are many things at play in the practice: technical objects, humans, noise, and light - almost all the objects that are required but without a territory (another object) within which to act there is nothing to be expressed, ‘without territory there may be objects or things but not qualities that can become expressive, that can intensify and transform living bodies.’ (Grosz, 2008, p.11) The workshop is the territory that frames the ‘objects or things’ as an expressive mode of sonic art creation and performance. The territory of interaction begins by exploring one of the brightest objects (Bryant) in the workshop, the hand. The reason for beginning with what may seem as an anthropocentric approach by focusing on the human hand is that, firstly, it is important to recall that by ontologically flattening the *transmission+interference* workshop the aim is not to completely remove the human and its powers from the making and performing processes and that, secondly, brighter objects contain greater powers than dimmer objects. The hand, according to Raymond Tallis, ‘is totipotential and so can develop in whatever direction will be of benefit.’ (Ingold, 2013, p. 116) This offers an object that will guide this section of the chapter where touch, haptics, knowing, telling, holding / gripping, making, and breaking are

realised as expressive acts of rhythm producing lines of flight across the territory.

The hand also provides a connection back to discourse from Whitehead around *prehension* - it is not only about physical touch but of moving throughout the feeling space of the objects in the workshop assemblage.

The workshop in the post-digital setting enables a re-engagement with the hand that actively confronts the de-skilling produced through homogenous factory production mentioned in the previous section of this chapter. To take part in the workshop involves the act of 'getting your hands dirty'. This phrase is fully realised in the workshops of *transmission+interference* as well as in those of Martin Howse and John Richards. Within a workshop of digital technologies the processes of writing, copying / pasting, and hacking digital code can bring to light this phrase - getting your hands dirty speaks of controlling and manipulating a material in a way that is potentially expressive of new outcomes because of the affect of the hand upon the material. However, after taking part in an EARTH / CODE workshop by Martin Howse the participants will have encountered that digital world of code writing but will also have dirt under the finger nails, dirt on their hands through connecting with the material of earth. Similarly, in *transmission+interference*, dust forms a coating on the fingers and the hand (as the viscous hyperobject that it is) - these workshops literally deliver the phrase as an encouragement of how to 'get to grips' with not only the materiality of the workshops but also the concepts. To get your hands dirty implies a certain playfulness in searching through dirt with your fingers to produce outcomes. In the field of physical computing, this searching by hand is done through plugging and unplugging patch cables on a breadboard that,

in turn, make and break electronic circuit connections enabling the user to find solutions by hand. The actions of wiring up an Arduino circuit take influence from the world of analog synthesis where physical patch cables are connected / disconnected by hand. Both of these practices suggest that more than a simple feeling out of the physical territory and its materials (cables, connections) is done by the hand but that it is connected to the act of thinking about the creative act in play. In analog synthesis, the hand is finding the connection and involved in decisions about the resulting sound that plays out from the loudspeakers. Leroi-Gourhan argues that in our post-human condition, where we have become de-skilled and separated from the making process and shifted into the mode of passive consumption, 'not having to "think with one's fingers" is equivalent to lacking a part of one's normally, phylogenetically human mind.' (Ingold, 2013, p.123) This act of thinking *with* the hand connects this discourse to the phrase coined by media archaeologist Erkki Huhtamo when describing the methods of practice developed by artist Paul DeMarinis. Huhtamo has neatly combined the word of thinking with the word tinkering to come up with *thinkering*. The concept of tinkering has been developed from the practices of artists who are primarily engaged in exploring technologies and their hidden potential. When describing the working methods of collaborator Jim Pomeroy, DeMarinis details tinkerers as those 'who bypassed or defied the intended uses of technology, who disrupted the hierarchy of the messaging apparatus.' (cited in Kahn, 2013, pp. 201-202) This returns to the discourse around Yasunao Tone and Nicolas Collins from Chapter 3 where they intentionally explored creative paths within technologies that were not intended by the manufacturers but here the focus is on the assemblage of hand, brain, and

technology - the *thinker's* toolkit! The term of tinkering has become more prominent of late due to the popular emergence of physical computing with Arduino and Raspberry Pi technologies, which offer a playful environment for prototyping and sketching out ideas with physical electronics (sensors and actuators) and code - connecting the feel of authenticity that comes with the *handmade* tool with the world of the digital. With these technologies the hand has become expressive through material objects into the world of code. Huhtamo develops this connection of *thinking* expressively as a method of the hand in describing the methods of DeMarinis in Jussi Parikka's book *What is Media Archaeology?* (2012). He describes DeMarinis as using 'anything at hand' (2012, p.141), which suggests a very open and playful approach to creating artistic work with technologies. Nothing is off limits as DeMarinis explores the potential of speakers, light bulbs, electronic circuits, and media players to resonate in new ways with other machines - to open these machines up to the flows and territories of other machines. Within *transmission+interference* the method of *thinking* employs the hand in feeling out the territory of machines to understand the vibratory flows of sound and the motion of the motors to create an assemblage that is now reaching beyond the anthropocentric view of the workshop of only the human feeling across the territory in order to engage in the more object-oriented view of the hand thinking through objects as they too feel out across the territory. Although not expressed by Huhtamo, the term of *thinking* owes much in debt to the concept of the *bricoleur* introduced by Claude Levi-Strauss and further developed by Deleuze and Guattari when discussing desiring-machines. The *bricoleur* is described by Levi-Strauss in opposition to the strict production rules of the engineer, linking the practice much

more so with the world of the handyman and amateur crafts. DeMarinis is the *bricoleur* when he is using ‘anything at hand’ for any creative task or project. The *bricoleur* is defined by their flexibility in the making process because of how they operate along with an assemblage of any other objects that are not specifically assembled for a set task or project. They are working with ‘anything at hand’ and often these objects bear ‘no relation to the current project, or indeed any particular project’ (Levi-Strauss, 1966, p.17). There is a correlation here with the workshops of *transmission+interference* that have developed over time and, in doing so, have accumulated a set of disparate objects and materials that have travelled across workshop to workshop. Some of these objects do directly relate, such as the LED or the input jack, but across time various objects have been included that were not of direct importance but then became entangled in the project through processes of using ‘whatever is at hand’ (ibid, p.17). A good example of this is the elastic band, employed as an object to vibrate and disrupt light signals that passed over it when stretched out simply because it was an object used for packaging up other objects between workshops (to wrap around boxes to keep them closed in transit) - the elastic band was not initially included on the workshop surface for its ability to create sound but it became so through acts of *thinkering* in the manner of a *bricoleur*. Through these methods of action in the workshop there is an invention of embodied knowledge that only occurs through expressive assemblages of objects that builds on the thoughts of Gilbert Ryle who wrote about the differences between ‘knowing that ...’ and ‘knowing how...’(DeLanda, 2016). Manuel DeLanda claims that ‘the most important difference is the mode of transmission: know how is *taught by example and learned by doing*, [...] its transmission need not involve

language.’ (2016, p. 80) In *transmission+interference* a participant may know *that* an elastic band makes a sound (for example, when it is stretched and plucked) but it is through the workshop assemblage that participants can know *how* an elastic band can be opened up to new methods of sound making.

‘Knowing how is embodied knowledge, but it is also flexible knowledge, because skills learned in one context can be adapted to many other contexts. It is this flexibility that gives the workshop, as an emergent whole, its capacity to deal with variation in materials, procedures, and products.’ (DeLanda, 2016, p. 80)

The embodied knowledge of *know how* is thus flexibly linked to the *bricoleur* as they wander through their field of objects and materials at hand inventing new (in the case of *transmission+interference*) sound and light experiences that are only possible through the workshop assemblage: ‘[a]n assemblage is [...] a veritable invention.’ (Deleuze and Guattari, 1987, p.448) Thinkering itself was questioned and played with in the *Thinkering (Un)Symposium* (Prior & Strang, 2016) that emerged from the critical making network *Hotwire~* in Plymouth, UK setup and organised by Prior and Strang. The incentive behind the *unsymposium* was to directly challenge the modes of information transmission and move beyond simply telling towards a collective space of making and doing. Three workshops were run exploring live coding, transduction, and modular synthesis where human participants were encouraged to learn through doing. For example, in the transduction workshop (Morten Riis), participants were using transducers, oscillators, and physical materials to explore rhythm, noise, resonance, and materiality to collectively create a live performance. Instruction came not from Riis but from the materials and their relations when set into vibration through sound that were felt out across the

workshop surface. The resulting performance operated as a new machinic assemblage formed through the processes of thinkering through objects and machines.

This discourse of the hand, making, and knowledge is picked up by anthropologist Tim Ingold in opposition to Michael Polanyi (1966) when he stated 'that we know more than we can tell' (Ingold, 2013, p. 109). Polanyi was trying to show that through craft based experiences and practices much of the knowledge remains with the practitioner, unable to tell of those experiences mainly because Polanyi relates that transmission of knowledge as an act of telling with words through text or speech. Ingold correctly challenges this position by stating that 'we *can* tell of what we know through practice and experience.' (Ingold, 2013, p. 109) To instruct someone to build and play an *Elastic Band Drone Machine* through text or speech would be an extremely laborious process and likely lead to failure, where language becomes too technical or not technical enough and cannot precisely tell, for example, how much physical pressure to apply between fingers and elastic bands. How to instruct the participant to build up multiple points of resonance across the machine so that sonic energy shifts in and out of phase is almost impossible to tell. To share the knowledge through making constructs a more immediate mode of delivery and reception where those learning can be guided by more knowledgeable practitioners and essentially 'grow into the knowledge of their predecessors' (Ingold, 2013, p.110). This develops a line of knowledge able to be mapped back through the history of the workshops where novices become experienced, and the experienced become further experienced all through the

making practice at hand. Knowledge becomes embodied in the assemblage of all the objects (hand, elastic band, vibration motor, LED, etc) and unfolds in new ways through each subsequent sharing which also includes new mistakes that are encountered due to any material differences between workshops (there could be a slightly different assemblage of objects at hand or a different quality of the same materials). This does not make a closed system of learning whereby the experienced practitioner has learnt all and then imparts that knowledge - through the process of sharing the skills through making, new objects will emerge (through mistake, for example) simply due to the difference of each subsequent sharing. This mapping of knowledge transfer defines territories of information about *transmission+interference* that follows the structure of the *rhizome* as defined by Deleuze and Guattari. At this stage in the discourse around territories it is important to unpack this complexly knotted concept in order to fully realise the connections and flows throughout the workshop practice which includes the biological, the geographical, and the musical (sonic).

There are certain key principles of the rhizome outlined in *A Thousand Plateaus* (1987) that are essential to understanding the flows and territorial make up of the *transmission+interference* workshop. Firstly, there is the link to cartography (see also *Onto-Cartography* from Levi Bryant) through the concept of mapping, not tracing! The map is an open structure that 'always has multiple entryways' (1987, p.14) and the structure of the workshop allows for multiple human and non-human objects to enter into the field of resonance in multiple ways (through, for example, light, sound, physical vibration, haptics, electromagnetic resonance) and these are

also constantly in flux, opening up to new connections from which the unknown can emerge. Deleuze and Guattari establish this concept of mapping as separate from a tracing as a tracing 'always comes back "to the same"' (ibid, p. 14). The early structures of *transmission+interference* workshops had more in common with the act of tracing - covering the same paths of information and technological techniques again and again, essentially tracing the build of one machine onto each subsequent workshop with no, or very little, opportunity for the emergence of new experiences. "The map has to do with performance" (ibid, p.14) and the workshop is a performative space entangling the human and non-human. To return to earlier discourse around production and re-production in Chapter 3 - the tracing follows the path of reproducing in an orderly way, not allowing for the emergence of the new, whereas the map is a performative mode of production, an active process allowing for creative approaches where '[i]t can be torn, reversed, adapted to any kind of mounting, reworked by an individual, group, or social formation.' (ibid, p. 13-14) To develop this concept of the performative mapping process further it is thus possible to add the concept of *The Fold* (1993), as established by Deleuze, to this assemblage. The workshop can form multiple connections across itself that are never the same (in subsequent workshops) where objects fold into and out of one another in a process of 'enveloping-developing, involution-evolution.' (Deleuze, 1993, p. 9) However, it is not true to simply state that all objects unfold into all connections with all other objects, as already discussed in Chapter 2 on Objects through the writing of Levi Bryant. Deleuze looks to the field of biology, epigenetics in particular, in an effort to detail the ability of an organism to fold and unfold itself in a limited way. The workshop of *transmission+interference* is the organism, which

here is termed the machine, that functions in a similar way to Deleuze's description where '[t]he first fly contains the seeds of all flies to come, each being called in its turn to unfold its own parts at the right time.' (ibid, p. 9) This concept of mapping in the form of epigenetics details how mapping is not routed to only one occurrence of the workshop, it is not limited to only showing the immediate connections but must be understood across time and space to allow for a full mapping detailing the unfolding of new connections emerging from the seeds of previous workshops. Objects that lay dormant / unused in one workshop may potentially emerge as dominant in the next due to new fields of resonance, but the objects that lie dormant do not disappear completely, there is a shift in the scale of the object in its capacity to affect. As Deleuze states, and is picked up by Bryant's bright objects and Harman's withdrawal of objects, 'to unfold is to increase, to grow; whereas to fold is to diminish, to reduce, 'to withdraw into the recesses of the world'.' (ibid, 1993, p. 9) The performative mapping principle of the rhizome allows for this shift, a tracing does not.

Before moving onto the second principle of the rhizome it is useful to pick up on the introduction of the biological term *epigenetics* alongside energetic vibrational resonance that act within assemblages (*transmission+interference* workshops) in order to connect to thinking from Rupert Sheldrake and his (controversial) theoretical concept of *morphic resonance*, that itself builds on concepts of entelechy, resonance, individuation fields, vibration, transmission, and reception (Bardini, 2011) to offer a potentially interesting view of a workshop's memory over space and time. Morphic resonance enables a thinking about the way that

workshops share memories where ‘past forms exert a virtual influence on the present form, which actualises them through differences and repetitions.’ (ibid, p. 106) This is not through a resonance of traditional energetic forms but instead a vibrational patterning across space-time but that builds on the past.

Transmission+interference workshops, over time, build up new machines and new knowledge about the development of machines that is transmitted and received between subsequent workshops through various means of online documenting but also through the objects and workshops themselves. Having established in Chapter 2 that objects and machines have inner powers and directions of those powers can be organised with the power of a vital entelechy, viewing the workshop as a machine that contains resonant powers that can determine its path of development built up through the objects that individuate it, it is possible that those powers can shift across workshops where each past workshop is pressed up against the present, ‘morphic influences of past organisms may simply be present to subsequent similar organisms.’ (Bardini, 2011, p. 106) This concept of morphic resonance is related to Shannon and Weaver’s theory of mathematical communication (Chapter 3) as Sheldrake imagines them as structures of information, or to frame it within context of this section of the thesis ‘fields of information’ (ibid). This information is contained in all the objects of the workshops that shift in brightness to have greater or lesser influence over the present but they exist equally in there, resonating their potential through their previous historical use.

The second key principle of the rhizome, as outlined by Deleuze and Guattari, in regards to *transmission+interference* workshops is the ‘principles of connection and

heterogeneity: any point of a rhizome can be connected to anything other, and must be.’ (Deleuze and Guattari, 1987, p. 7) What emerges from this part of the concept is that a rhizome aims to be abstract through its connections that actively ‘bring into play not only different regimes of signs but also states of things of differing status.’ (ibid, p. 7) The assemblages of human and non-human objects across a workshop actively combine people from differing disciplinary backgrounds (participants in workshops have come from fine arts, music, computer science, engineering, architecture, digital media arts, design, creative writing) as well as disparate non-human objects that are not often found in combination until recent developments in workshop practices resulting from circuit bending, tinkering, tinkering, bricoleur, and hacker / maker communities. In these such spaces the combination of objects are a perfect example of this principle of the rhizome - objects are combined in ways that forge connections across disciplinary borders in a method to experience the differences. ‘[t]he rhizome connects any point to any other point, and its traits are not necessarily linked to traits of the same nature’.

(ibid, 1987, p. 23) The third principle of interest within this thesis is the ‘principle of asignifying rupture’ (ibid, 1987, p. 10) that establishes a connection between the structure of the workshops, how they form and produce emerging properties, and with the field of sonic noise. Here *transmission+interference* confronts its greatest form of interference, the rupture or the rogue object (Bryant), as a form of potential for making and it is this particular principle that is key to establishing the hacker / maker communities within which it sits. ‘A rhizome may be broken, shattered at a given spot, but it will start up again on one of its old lines, or new lines.’ (ibid, 1987, p. 10) From a technological point of view, the workshops constantly face points of

rupture that do not act to stop the development of ideas or sounds but instead become deterritorialized⁸ along new lines of flight. The rupture calls to attention an event that resonates with what Roland Barthes would term as the *punctum* in photography where an accidental artefact in an image will 'prick' the viewer (2000), in this case the 'viewer' is possibly non-human. This is an event of surprise, similar to the rupture, that offers new, unknown potential to the making process enabling a shift away from what is already known. As Barthes states, '[w]hat I can name cannot really prick me. The incapacity to name is a good symptom of disturbance.' (2000, p. 51) The literal breakage of a machine becomes a rupture in the making process where it may not be necessary to attempt to simply fix that machine back to original working operations, instead the rupture offers the potential for opening up this machine now to new possible connections, to ask the question: what else might unfold from this machine? Within the field of making practices that *transmission+interference* sits it is easy to focus on the technological ruptures where objects and machines are appropriated in ways that alter their intended, manufactured operations. However, with the assemblage of human participants from across multiple disciplines (as mentioned above) these ruptures occur across language, learnt knowledge, and technical skillsets. A musician will explore the potential of deterritorializing a DC motor in different ways than an engineer might -

8. The term *deterritorialization* from Deleuze and Guattari is fully developed in *Of the Refrain* (1987) as the process of a machines becoming. They use the example of a synthesiser that is deterritorialized from a piano - it has become a new machine entirely but out of the territory of the piano. The term also returns to *lines of flight* as it is along these that deterritorialization enables flows.

an example of this is mentioned by Nicolas Collins where, instead of applying power to make the motor spindle spin, one might physically twist and turn the motor spindle producing sound from the motor's (now newly deterritorialized) sound outputs. Sound and music provide a unique expression of the rupture as a sonic moment that can arrest the attention of objects utilised in its making, as noticed by Jacques Attali when commenting that John Cage's *Silence* announced 'a rupture in the process of musical creation' (Hainge, 2013, p. 56). The forms of sound produced from the various machines of *transmission+interference* rupture the workshop flows in ways that, for example, the visual could not achieve. The sudden emergence of a burst of complex noise or deeply resonating layered drones from across the workshop space has the force to rupture others out of their working processes, establishing new connections to their materials once they re-engage. 'Music has always sent out lines of flight [...] that is why musical form, right down to its ruptures and proliferations, is comparable to a weed, a rhizome.' (Deleuze and Guattari, 1987, p. 13) Perhaps it is necessary to begin to talk of *sonic* lines of flight as a specialist form of deterritorializing due to sounds expressiveness through rhythm and vibration - a sonic line of flight captures the rhythmic and vibratory worlds of feeling coming from Bachelard (2000) and Whitehead (1978).

The final point about the rhizome that needs to be included here is regarding its position and movement. 'A rhizome has no beginning or end; it is always in the middle, between things' (ibid, p. 27) The nature of this connectivity suggested by the concept of the rhizome brings forth further ideas of excess as the practice of *transmission+interference* grows out, or unfolds, from the middle, spilling beyond

borders in a manner that reflects the concept of *zao* as mentioned in Chapter 3. Noise overflows in-between machines as the workshop itself flows out on lines of flight carried by the material objects (Grosz, 2005). Human participants take the skills and knowledge and build upon them, alter them in ways that reflect Booker T. Washington's original plans for the workshop community to develop new work beyond the workshop. The non-human objects equally operate as carriers in-between through their resonant relations across the workshop suggesting newly, different couplings for new sonic outputs. As Deleuze and Guattari suggest, rhizomes 'nullify endings and beginnings'(Deleuze and Guattari, 1987, p. 28) exposing the workshop as an object defined by speed and duration but it is not only a place where speed is increased, as Deleuze and Guattari suggest, the workshop also slows motion between things. In the workshop we are encountering the process of difference that is only possible through a durational experience (Grosz, 2005) and this is reflected between the human and non-human objects entangled in the workshop. A capacitor, for example, sits in a circuit and fills up with energetic signal and then releases it after a time according to its size, this technical process is reflected in the human participants that fill up with certain skills and knowledge before releasing them into the workshop, or into later workshops / performances. This resonates with the concept of *mirror-tools* (Sennett, 2008), previously mentioned in Chapter 2 on Vital Materialism, which operates as a flattening method between all objects as a realisation that certain actions and operations are shared amongst the diverse variety of objects, whether human or non-human.

These principles of the rhizome are the building blocks of what is, if we follow in the steps of Levi Bryant's *Onto-Cartography, the world* (2014) of the open workshop that is formed of the territorial assemblage through mapping difference, deterritorialization, and rhythm. Bryant develops this concept of worlds, mapping, and territories through Deleuze and Guattari but somehow does this without referring to their text on *The Refrain* which directly deals with territorial becomings that would enable a greater understanding of the forming of noisy worlds. The aim here is to now combine these for a fuller understanding of worlds formed through the assemblages of machines in *transmission+interference*. Onto-cartography offers a great deal of critical discourse to this field as it directly deals with the in-between-ness of machines, the 'relations between machines or networks of machines composing a world' (Bryant, 2014, p. 111) is precisely what it maps. However, it would be better to state that it maps assemblages of machines rather than networks to 'allow for contiguity in a fleshy sense, touching, incorporating, repelling, mutating.' (Hayles, 2017, p.118) Hayles admits that there are similarities between networks, especially dynamic ones, and assemblages but they lack the complex potentiality of interactions and informational exchanges that assemblages afford (Hayles, 2017). To then consider assemblages of a rhizomatic nature is to encounter these 'mutations' as Hayles describes. Things are not only able to change (brightness) but there is encouragement for change, for objects to withdraw, as both Deleuze and Harman understand, and to (re-)appear. *Transmission+interference* is a world that is composed of 'loosely coupled assemblage[s] of machines interacting with one another through the mediation of other machines in an ecology.' (Bryant, 2014, p. 114) The machinic assemblages of this world are the LED Transmitter,

elastic band, resistor, 555 timer circuit, hand, vibration motor, human participants, and on and on. What is essential in order to understand how these machines function to exist within the world of *transmission+interference* is that none of these are privileged above others as active agents within the creation of sound and noise. A world in onto-cartography is ontologically flat (as detailed in Chapter 2), all machines exist equally (Bogost, 2012) and now operate in an assemblage that has developed beyond the term of 'auctoritas' (Sennett, 2008) where a master led through fear and awe over his apprentices. Bryant states, '[t]o be in a world is to be decentralized, to lack all mastery, and to be a participant in an assemblage' (2014, p. 114) and this framing could be developed with Deleuze and Guattari's concept of the refrain (1987). Each machine, as a participant, both ontologically flattens the world but also positions all machines and, therefore, all territories of the world in a state of becoming, they are each deterritorialized and deterritorializing. By entangling the refrain within the world of onto-cartography it is now possible to pursue this discourse through a purely sonic method as the refrain is understood to be specifically 'when an assemblage is sonorous or "dominated" by sound' (Deleuze and Guattari, 1987, p. 356). The refrain brings in discourse of chaos and rhythms that are essential to understanding the noisy machines in the world; rhythms which are born out of chaos (ibid, 1987, p. 345) but '[w]hat chaos and rhythm have in common is the in-between' (ibid, 1987, p. 345). If onto-cartography is a mapping of machinic relations and assemblages of machines then it is a mapping of chaos, rhythm, noise, and difference that exists in the in-between. It is a mapping of deterritorialization in action - a machinic assemblage in its state of becoming that can never be complete. As Bryant states, '[w]orlds are fuzzy and

without clearly fixed or defined boundaries and elements. [...] they lack fixity.’ (2014, p. 122) This does not mean that they are so vague so as to not be possible to define - *transmission+interference* can be defined as a workshop, as an assemblage of machines, as a performance, or as an interactive installation but each of these worlds has the capacity to shift and alter itself at the level of components, as any assemblage can. It is the qualities or expressiveness (Deleuze and Guattari, 1987) that emerge from within the activities that take place in these worlds that define the territory. Bryant usefully continues his discourse of worlds and mapping through *geophilosophy* (2014) to unpack the types of maps required in an onto-cartographic study:

1. Bright objects and satellites
2. how machines are linked
3. sources of energy
4. material outputs

(2014, pp. 260-263)

Firstly, it is necessary to understand the objects that organise the workshop and take care to avoid an anthropocentric (over)view of this - in the refrain this can be identified as the territorial markings of the objects. Secondly, the mapping delves into the in-between to explore the interactions between machines and their structural openness - the refrain reference here is the deterritorialized lines of flight operating between machines. Thirdly, Bryant suggests one of the refrain’s *indexes* - energy sources - as a necessary mapping. Here is the development of an

understanding of rhythm and chaos, the key sources of territorialization in the refrain. Finally, it is necessary to map the material outputs that could be considered as 'the becoming-expressive of rhythm or melody, in other words, in the emergence or proper qualities (colour, odor, sound, silhouette ...).' (Deleuze and Guattari, 1987, p. 348) It is this final map that where the core interest lies, the culmination of the three previous maps, the objects have become open to particular flows and energies and spill forth an excess of expressive qualities that will now be explored to close this section of the chapter.

Elizabeth Grosz (following Deleuze, Bergson, and Uexküll) unpacks these expressive qualities as 'sensations' (Grosz, 2008) unfolding from materialist compositions which entangle the human and non-human. If onto-cartography were able to map the sensations of assemblages, territories, and worlds then, according to Grosz, a map of forces could be created, in particular, a map of vibrational and resonant forces understood as sensations. Grosz positions sensations in the relational in-between that resonates with the 'fuzzy worlds' of Bryant that 'lack fixity' when she states that '[s]ensation is neither in the world nor in the subject but is the relation of unfolding of the one for the other through a body created at their interface. [...] sensation is that which cannot be mapped or completed, always in the process of becoming something else.' (Grosz, 2008, p. 72) *Transmission+interference* is working with objects of expressive qualities, assemblages of expressive qualities, and operates as workshops of expressive qualities to build machines, performances and installations of expressive qualities. The sensations of these objects and outputs though are not in the human participants or the audience but they are in the

whole of *transmission+interference*. The workshop is made of sensations. The discourse around sensations developed by Grosz is shared by Erin Manning in her text on *Artfulness* (2015) as they both reveal sensation to be made from forces, energy, rhythm, and resonance (2008). Grosz is discussing the creation of Artworks and Manning is dealing with art across time but what they have in common is sensations which are essentially vibrational, either within the making or within the objects (human and non-human) of making. In this they both follow Deleuze's clear statement: 'sensation is vibration' (Deleuze, 1993, p. 39). Grosz gets to the core of all activities within *transmission+interference* through chaos, rhythm, territories, and the refrain, all the elements resonating within this thesis and across the workshop by introducing the term 'dance of forces' (2008) which is employed here as a development on Pickering's 'dance of agency' mentioned in Chapter 2.

'What seems to be transmitted, transformed, located, and relocated in this dance of forces that moves from chaos to milieu and then to territory and, conversely, from rhythm to the refrain and then to music is nothing but *vibration*, resonance, the mutual condition both of material forces at their most elementary levels, and of music at its most refined and complex.' (Grosz, 2008, p. 54)

There is only vibration and resonance expressed by the dance of forces within the workshops of *transmission+interference*. The chaos of noise across a workshop is vibrational force felt in the participants' bodies and the material objects where 'we are no longer beings but vibrations, effects of resonance, 'tonalities' of different amplitudes.' (Manning, 2015, p. 48) These resonant vibrations are equally the chaotic flows of turbulence (Serres 2001) as they are transductive organisations of energy (Simondon, 2017). They are formed through the noisy encounters between

machines; these sensations are what any object of the workshop is prehensively feeling and Whitehead develops this feeling concept as *vector feelings* - 'feeling from beyond which is determinate and pointing to a beyond which is to be determined.' (1978, p. 163) This is the creation of worlds for Whitehead, always *in potentia*, with vector feelings that 'cannot be mapped in advance, and whether it lands in a way that activates a worlding cannot be predicted. But it can be modulated, and this is the art of participation.' (Manning, 2015, p. 74) The thesis will now move on to tackle this participation now through DIY and DIWO practices.

4.4 DIY / DIWO

Keywords: Maker, Hierarchies, Critical Making, Participation, Sympoiesis, Difference

‘Masterpieces are not single solitary births; they are the outcome of many years of thinking in common, of thinking by the body of the people, so that the experience of the mass is behind the single voice.’ (Woolf, cited in Mansoux & Valk, 2008, p. 14)

The sensations of the previous section and feelings of Chapter 2 are not an individual experience. In the ontologically flattened world of the workshop they are a collective experience shared between the human and non-human. In this section of the chapter the assemblages of objects involved in practices of artistic making in *transmission+interference* will be explored via updated making methodologies that begin with Do It Yourself (DIY), progress to Doing It With Others (DIWO), leading to a reinterpretation of these methodologies that actively entangle noise and the non-human. The immediate critique of DIY begins here with a statement from biologist Scott Gilbert that will resonate with the final part of this section through Donna Haraway as well as with discourse through Simondon’s *individual*: ‘[W]e have never been individuals.’ (2017, p. M71)

DIY culture has a very problematic and dominant hold over both the making practices of *transmission+interference* and the sonic outputs. There are certain characteristics of DIY that are still beneficial and useful today such as the raw punk spirit of creating on your own terms and often in ways that are cheap / affordable. However, the empowering factors of being an artist / musician who can do-it-themselves overwhelms what is the actual true nature of making and what it truly *involves* to produce outputs. The long held perspective of the craftsperson who

tinkers (or thinkers) around materials is positioned within DIY culture and this perspective has then been borrowed by the arts and found a particularly strong footing within the practice of music and the emergence of sonic arts in an effort to re-address the hierarchical structures that existed (for example, the position of the composer). Instead, through DIY methods a bottom up structure was allowed to emerge that began to take into account the technologies in use through open source software and hardware hacking, electronics, and circuit bending (Richards, 2013). Ironically, it is through the ability of these technologies and approaches to technology to be shared widely and freely amongst other users and makers that these practices developed strong DIY aesthetics. The term of DIY inadvertently folds back into the hierarchical structures of the creative genius who stands alone as the *Homo Faber* or 'man as maker' (Sennett, 2008) even though that person may actively borrow and share technical knowledge and skills from within the artistic field. The development of GNU / Linux between 1983 and 1991 provoked a shift within artistic software practices that resulted in the term FLOSS (Free / Fibre / Open Source Software), promoting the idea that software should be 'used, copied, shared, modified, and redistributed with little or no restriction.' (Mansoux & de Valk, 2008, p. 7) This emergence of FLOSS practices began to create artistic communities through code, for example, in the sharing of Pure Data patches or the multiple authors of code that contribute to the libraries of Pure Data objects. Along with the sharing of code was the valuable documentation that accompanied new changes in software so that users could learn for themselves from within the community. FLOSS strangely mixed DIY and community making (oRx-qX, 2008) but the users were never involved in a DIY practices as they were always relying on

software version updates from within the community or support on platform forums and this is before any consideration of the materials involved in the construction of the network that supports the entire community. The above quote from Virginia Woolf fits well with how FLOSS originally emerged but it fails to engage with the material level, just as FLOSS did. Another critique of the term DIY is that it eschews not only other people and the relevant technologies that are involved in the making processes but also the disciplinary backgrounds and external influences that form creative practices. Douglas Kahn uses the example of American experimental artist / musician Gordon Mumma to detail certain DIY aesthetics and in doing so includes a comment about the excesses of war in America after the Second World War. Suddenly army surplus stores were filled with electronics and radio kits perfectly suited to the sonic arts thinkerer practices of opening them up to explore their creative, sonic potential - 'live electronic music and DIY across the arts in the United States benefitted from military excess.' (Kahn, 2013, p. 154)

It is therefore possible to critique the term DIY from a technical standpoint to a degree that makes it a ridiculous, egotistical statement. It is also possible to critique the term DIY from a new materialist and object-oriented perspective through Simondon's philosophy around the *individual* which removes the very concept of a standalone, single individual being present at any stage in the making process since '[t]he source of all individuals, preindividual being, is not *one*.' (Combes, 2013, p. 3) Instead, Simondon develops the concept of the individual as an emergent system (coming from the field of thermodynamics) that is formed of 'information, internal resonance, potential energy, and orders of magnitude' (Combes, 2013, p. 5) and

cannot be reduced to just one identity. In fact, to follow again in the steps of *zao* and an excess of noise (as well as an excess within objects), 'being should be called *more-than-identity*. [...] being is *in excess* over itself.' (Combes, 2013, p. 3)

The individual being that is at the very root of DIY-ness does not exist in a new materialist / OOO world where the individual is an emergent system always in the process of becoming, which, for Simondon, occurs through phases and modulation which require (a dance of) forces that he calls energetic potentials (Grosz, 2017).

DIY also suggests degrees of being closed to outside influence but in following Simondon's individual with the potential that they contain and the excess of being more than itself 'every individual is open to becoming more' (Grosz, 2017, p. 186) - the individual that is *open to* resonates with Sennett's workshop, Bryant and Bogost's Alien Phenomenology, and the hardware hacking practices of Tone, Richards, Howse, and Collins. Finally, Simondon's individual is not focused solely on the human being, which acts as another critique of DIY as it tends to ascribe *Yourself* to a single human creator of art disregarding the power of technical objects. The individual workshop of *transmission+interference* is a fuzzy world without fixity due to its phasing and dephasing excess of being that is not centred around one individual being. Instead, the workshop environment actively builds around a more social, collective experience between humans and non-humans that splits from the limiting view of DIY and is better framed within what is now known as Doing It With Others (DIWO).

DIWO emerged as a term in 2006 from the London based gallery *Furtherfield*, run by Ruth Catlow and Marc Garrett. The term playfully leans on the aesthetics, practices,

and politics involved in DIY but brings them up to date and operates as a much more inclusive term for art creation. 'DIWO is a manifestation of grounded explorations and collaborations between networked peers, whose practices involve an open mixing of components from different sources, building new hybrid art experience.' (Catlow & Garrett cited in O'Hara & Bradbury, 2019, p. 63) DIWO became a way of thinking how to make in early net-art cultures and had a particular focus on web only activities across digital networks that were engaged in collaborations of multiple people distributed across space and time. It became apparent quite early on that the term could be used much more widely to include non web based practices, including those that might have previously been thought of as DIY - circuit bending, for example. One outcome from Furtherfield's first DIWO event was the production of a DIWO manifesto:

It's DIWO if it...

- Enlarges artistic freedoms
- Uses the metaphors, tools, cultures and processes of digital & physical networks
- Is led by experimental artistic processes rather than utilitarian or theoretical concerns
- Disrupts traditional hierarchies and concepts of ownership working with decentralized peer 2 peer practices
- Involves diverse participants (unwitting and active collaborators), ideas and social ecologies

- Generates unruly and provocative relationships between symbolic meanings and material effects
- Co-creates a new, freer, art context for more and more diverse people

(Catlow & Garrett cited in O'Hara & Bradbury, 2019, pp. 70-71)

From this manifesto it is possible to question the DIWO-ness of *transmission+interference* and also question if this manifesto is capable of dealing with the complexities of a noisy new materialist / OOO approach to making in complex assemblages or whether a new / updated manifesto is required. This critique will begin by exploring the participants (human and non-human) of the workshops before moving onto to issues of hierarchies and artistic creativity.

DIWO serves as a term that is encouragingly inclusive to people. Within an anthropocentric framework *Others* immediately invokes a mixing of other people that operates as an act of opening up (that term again!) creative practices and processes to more hands, bodies, and minds - perfectly supported by Woolf's quote at the opening of this section. The potential power of humans mixing and acting together is a realisation of what Hannah Arendt terms *natality* (2018), where new interruptions are the actions caused by new, different participants in the world which links back to discourse in Chapter 3 around the participants within the installation of *transmission+interference: digital synesthesia* (2016). '[T]he newcomer possesses the capacity of beginning something anew, that is, of acting.' (2018, p. 9) The (re-)mixing of humans in DIWO forces interactions of new initiatives, ideas, and skills that will inevitably disrupt any chains of events set in motion by previous

actions (2018). The idea of the social is fully embraced in DIWO and importantly they include both 'unwitting and active collaborators' but don't quite go far enough to shift into a more non-anthropocentric frame that would actively include the non-human. This positive move of human inclusivity in the DIWO manifesto resonates with what Erin Manning and Brian Massumi describe as 'enabling constraints' (Manning, 2015, p. 52), as whilst DIWO is clearly positioned as a radical disruption to making practices it is not meant simply as a way to entangle everyone and everything at once. It will resonate with certain practices more than others - initially it related directly to peer 2 peer, net art practices and this formed certain contextual boundaries around the calls for participation. The inclusive approach is 'about crafting an ease of entry into a complex environment itself always undergoing modulation.' (Manning, 2015, p. 52) Manning's text frequently refers to human participation in the creation of art but also manages to look beyond the human, towards the excess of the human body and the environment to understand the ecology of creativity that includes human, light, perception, sound, and smell. (2015) Going beyond the material aspects too, Manning develops the concept of an artwork's *dance of attention* (that resonates with Sennett's *arousing tools*) where the interactions between human and non-human participants becomes increasingly complex. The human involvement need not necessarily be at the level of material adjustments but also in how it attends to the work when, as Deleuze and Guattari would state, "'it stands up" [or] creates its own momentum, its own block of sensation, its own field of forces.' (2015, p. 59) This *dance of attention* could be toward every aspect of the work and every component in a critical way that links with Matt Ratto's term of *critical making* (2011) that seeks to combine the

historically split worlds of critical thinking and physical making into a world where thinking and making are enmeshed into ‘an iterative process of reconfiguration and conversation, and reflection begins.’ (Ratto, 2011) Ratto has purposefully developed this methodology through a hands-on, making process that ties into the *philosophical carpentry* coming from Bogost and the attention to material consciousness (Sennett and Ruyer) mentioned previously in this chapter. The workshops of *transmission+interference* have developed through this world of practice, critically engaging with objects and their powers in order to explore ideas within the practice. An example of this is the development of the experimental *Stick Chart* (2016) workshops (run alongside *transmission+interference*) based on Polynesian stick chart cartography by Strang, Van Uffelen, and Von Jungenfeld in order to explore mappings of waves of energy. The practice is borrowed from Polynesian sailors who would map specific bays around islands by literally feeling out with their hands the physical vibration of energy from the ocean through the hull of their boats. These maps of energy were then constructed using the materials of sticks that washed up on the shores of those bays - using what is at hand and forging material links with the information that they held once constructed. For the purposes of the *stick chart* workshops, energy flows of spaces (WiFi, heating systems, flows of people etc) were mapped out using materials in an effort not to create a fully functioning and readable map but as a critical entanglement of humans with materials that presents a suggestion of the energies within the spaces of the workshop. This is a critical thinking through of objects, realising their potential of transmitting information to tell, that resonates with Ingold’s thoughts earlier in response to Polanyi. This actively combines humans and their powers with objects

and their powers. This discourse explores the potential of ‘diverse participants [...], ideas and social ecologies’ from the manifesto but a more radical way to develop and update DIWO as an inclusive, non-anthropocentric way of thinking and making for *transmission+interference* would be through Donna Haraway’s multi-species concepts of *string figures* and *sympoiesis* (2016).

String figures continue the line from dance of attention through critical making as they are both *thinking* and *making* practices (2016). String figures could even figure within Matt Ratto’s text on critical making due to their nature of combining thinking and making through cheap, basic materials (string) and that there is no goal that focuses upon creating new machines (Ratto uses the term ‘devices’). Simply making to ask new questions rather than create specific solutions also positions this practice within a speculative design framework, and string figures are speculative activities. ‘SF’ - science fiction, speculative fiction, string figures (Haraway, 2016). The *stick chart* workshops operate just like string figures, they combined thinking and making and transmission of information and they operated in a critical making space, not aiming for the creation of a technical machine but instead a machine that the maker learns through in the making process. Just like string figures, they are performative and playful methods of story telling through human, material, and rhythm:

‘Playing games of string figures is about giving and receiving patterns, dropping threads and failing but sometimes finding something that works, something consequential and maybe even beautiful, that wasn’t there before, of relaying connections that matter, of telling stories in hand upon hand, digit upon digit,

attachment site upon attachment site, to craft conditions for finite flourishing on terra, on earth. String figures require holding still in order to receive and pass on. String figures can be played by many, on all sorts of limbs, as long as the rhythm of accepting and giving is sustained.’ (Haraway, 2016, p. 10)

String figures are actively inclusive of material and human participants that should hold still, or engage in Manning’s dance of attention. Haraway focuses specifically on a Navajo string figure game called *Ma’ii Ats’áá’ Yíłwoí* (‘Coyotes Running in Opposite Ways’) which resonates deeply with this thesis on *transmission+interference* as a story where the dust of disorder is scattered by the coyote into the path of orderly patterns ‘setting up the noninnocent world-making performances of disorder and order that shape the lives of terran critters.’ (Haraway, 2016, p. 13) Just as in string figure activities, objects within the *transmission+interference* workshop take up a new line of development from existing lines of flight - light might be reflected in a new way across a new material surface causing new sonic vibrations, someone might press the wrong button on a device causing unexpected outputs from that machine. Each of these actions, in turn, pull on the thread of the workshop and its object relations and create new lines from which the next new body to interrupt the workshop can pull on. The world of string figures also operates structurally openly that is a strength of DIWO, ‘[t]he worlds of SF are not containers; they are patterning, risky comakings, speculative fabulations.’ (ibid, 2016, p. 14) To develop this *risky comaking* environment Haraway develops a line of thought from M. Beth Dempster that contrasts systems theory approaches of *autopoiesis* to arrive at the term *sympoiesis* - ‘collectively-producing systems that do not have self-defined spatial or temporal boundaries. Information

and control and distributed among components. The systems are evolutionary and have the potential for surprising change.’ (Dempster 1998 in Haraway, 2016, p. 33)

The term *autopoiesis* is related to *self*-producing systems that (similar to the hold DIY has had over making practices) has had a dominant hold over thought about how systems develop. Haraway and Dempster claim that systems are often mistaken for being autopoietic but are, in fact, sympoietic and DIWO methods could be developed along these lines to fully embrace the world of ‘making-with’.

Sympoiesis ‘is a word for worlding-with, in company. Sympoiesis enfolds autopoiesis and generatively unfurls and extends it’ (Haraway, 2016, p. 58) allowing for more complex ecological assemblages instead of networks.

Sympoiesis is a way to extend not just autopoiesis but also both Alien Phenomenology and Onto-Cartography through its *making-with* as this is a method that actively flattens the making space ontologically, bringing in all objects and machines and their relations to exist equally within the workshop.

Transmission+interference needs this sympoietic method in order to fully achieve a space to *make-with* noise, it enables a way to open up to all ruptures and disruptions from all human and non-human participants. Questions of ownership and traditional hierarchies are thus fully disrupted through sympoietic methods that actively develop complex assemblages of inclusivity which are central to DIWO and *transmission+interference*. The sympoiesis is a multiplicity of the rhizome (the third principle of the rhizome) as it deals with worldings of vast quantities that avoids a single unity that can be governed and controlled from above. It cannot be, to use Deleuze and Guattari’s phrase, ‘overcoded’ (1987) where there are ‘supplementary

dimensions over and above its number of lines. All multiplicities are flat' (Deleuze and Guattari, 1987, p. 9). *Transmission+interference* operates without any one machine or object overcoding all others; all actions, movements, and becoming are collaborative (Bryant, 2014). From the operations of the workshop into the performance *transmission+interference* does not position one machine over another; each machine remains structurally open to the flows of rhythm and vibrational energy that wander through the performance. It is not just in the workshop making process that machines are structurally open, this line continues throughout the performance and into the next workshop and on and on, following from Deleuze's use of epigenetics and Sheldrake's morphic resonance.

DIWO suggests an enlarging of artistic freedoms - following from Yasunao Tone's thoughts about artists enlarging technologies - that is occurring from this appreciation of the *others* collaboratively involved in artistic creative thought and action. This enlarging of artistic freedoms is the result of the shift from a singular point of knowledge and skill (in DIY) to a position that actively engages in different opinions, skills, disciplines, materials - different resonant vibrations.

Transmission+interference operates with this difference (as already discussed in both Chapter 2 and 3) as a means of creative production to enlarge the creative potential that is possible across the workshop. To gather a room full of computer musicians each well versed in only programming in Supercollider is likely to result in a creative output run in Supercollider - returning to what is known best within the group as it deals with creative struggles against time. Workshops truly engaging in DIWO methods construct diverse spaces of difference and this does not only relate

to human participants. As thinkering and bricoleur practices have enlightened the workshop environment it is clear there is a creative benefit to diverse objects that are not traditionally connected. Karen Barad has developed her theory of *diffractions* (as introduced in Chapter 2) following on from Donna Haraway, to understand how difference within entanglements (of human and non-human) matter (Barad, 2007). 'Diffraction patterns record the history of interaction, interference, reinforcement, difference.' (Haraway in Barad, 2007, p. 71) The combination of these four elements that make up diffraction are the very elements that enlarge or open up the artistic freedoms to explore new potential that are central to the DIWO-ness of *transmission+interference*. From a purely sonic perspective, the practice of *making-with* noise in order to create and output noise would simply not occur if not for difference - sound requires difference or it would, as pointed out by Serres (2018), simply cancel itself out. Serres' worlds of turbulence, noise, and chaos operate as the difference that we can hear and noise is perhaps the greatest difference, the greatest unknown, noise, for Serres:

'Is a set of possible things, it may be *the* set of possible things. [...] This noise is the opening.' (1995, p. 22)

To finalise this section of the chapter, before moving onto a synthesis of the thesis, it is necessary to once again return to dust as it noisily engages with the multi-species worldings mentioned above. To practice within DIWO is to fold in dust and noise into all parts of the machine - it cannot be escaped, so DIWO should open up to it, as Jussi Parikka mentions, '[d]ust takes us - and our thinking - to different places and opens up multiple agendas.' (2015, p. 87) A DIWO manifesto for *transmission+interference* involves dust and all the possible material collectives that

exist to form it in-between objects and on surfaces. Through workshops, dust is encountered and also produced by objects in processes of hacking, bending, and making to form new collectives; it is the object that cannot be separated from creation (Negarestani, 2008). As an object, dust operates within every one of the DIWO manifesto points - in order to do anything with others is to do it with dust.

‘Dust is the master of collective insurgencies.’ (Negarestani, 2008, p. 89)

4.5 Conclusion: Workshop

Through the interactions of objects with their individuating ruptures, interruptions by the new body, breaking and making new connections, and resonating vibrations across rhythms there is formed the workshop operating with and within noise.

Within this final chapter of the thesis the worlds of objects and machines and noise are brought together on the surface of the workshop in order to explore the making processes of *transmission+interference* and how this has emerged over time. The initial discourse relates to important developments in the workshop beginning from the experience of the craftsperson and the hierarchical structures of imparting knowledge in one direction that have resulted in much more fluid approaches of a conversational (Bakhtin) nature. Due to the initial efforts (in *transmission+interference*) of building LED Transmitters without knowing how to develop them into anything more interesting it was important to explore the power of the *auctoritas* (Sennett) mode of delivery and why it is important to be aware of the hold it has over the transmission of knowledge within workshop environments. It is then possible to move beyond and break this mode of delivery down, to ontologically flatten the world of the objects, machines, noise, light, and humans. Whilst much of the discourse centres on early workshopping practices that are in common with woodworking or traditional craftsmanship, space is created for influence from the world of sound and music and the important developments taken to break down the authority of authorship and the imposing figure of the controlling composer.

Key terms are introduced that are involved in the breaking down of hierarchies in workshops and that are actively included in the practice of *transmission+interference* that involve the hand, the brain, the object, and the machines operating across complex connections. Thinkering and the bricoleur are identified as vastly important (the bricoleur is cited as an influence in the methodology of this entire practice led research) terms that connect to the messy and noisy ways of making that are involved in the production of sound and light machines. These terms engage the technical objects and machines with the human to develop a workshop practice emerging from alien phenomenology and philosophical carpentry where thinking and making are engaged with through the objects and machines. This, too, later relates to the inclusion of critical making (Ratto). The framing of the creative workshop is done so within the concept of Deleuze and Guattari's rhizome in connection with their refrain which is entangled within Bryant's geophilosophical discourse around worlds. This enables the discourse of the workshop to move away from the strict confines and boundaries of network and to thoroughly engage with assemblages - the very vital assemblages of Chapter 2. This produces a workshop environment that has removed hierarchical positions of influence and importance and has engaged in the messy potential of ruptures throughout the making experience. Influence is felt from across the arts and music and but also, importantly, from within biology in regards to the emergence of new workshops over space and time that share information. The biology of rhizomatic structures and epigenetics are of huge influence over the concepts emerging from Deleuze and Guattari and this resonates with the concepts that emerge in this chapter from Sheldrake and Haraway. These messy flows of

connections and broken connections recall the problematic OOO positioning of lists and ontography from Chapter 2. The neatness and solitariness of objects listed or presented with only neighbourly connections (exploded view ontography, Chapter 2) are not capable of handling this level of complexity of interconnectivity. Only noisy entanglements can do this (Fig. 74 and 75).





(Fig. 74. (Top image) and Fig 75. (Bottom image) transmission+interference workshop mess)

Finally the chapter tackles the concepts of DIY and DIWO and is able to find important developments within DIWO that fit with *transmission+interference*, however, this research suggests that the entanglement of objects and machines is potentially messier and that an update to this manifesto is required in order to fully engage with human and non-humans operating together sympoietically within assemblages as opposed to networks. DIWO is a great development that has broken down the powers of DIY but it sits more within peer 2 peer network practices - more can be achieved in this collective making approach by engaging in

Haraway's multispecies worldings and dust can provide many of the approaches to this collective making. Through an engagement with Barad, Dempster, and Haraway's concepts the DIWO collective making workshop can become a pluripotent machine in regards to Bryant's discourse of the term. The pluripotent machine resonates in a variety of ways and contains 'a certain vagueness, a certain floating nature' (Bryant, 2014, p.52) that characterises *transmission+interference* and is expressed very strongly within dust but also within many of the flows and motions discussed in the thesis. Throughout this chapter and indeed across the entire thesis there has been a development of wandering (a vague, floating motion) that occurs that is difficult to capture but should be a point of development of the DIWO manifesto. These points will be addressed in the final synthesis chapter of this thesis.

This chapter concludes the discourse of the thesis that the individual with overcoding power is broken down so as to reveal the hidden powers of the relations between all objects and machines and indeed between histories and futures of those objects and machines too.

'We are more than individuals; we are still the whole chain of events which led up to us, and inherit all of *its* future tasks' (Nietzsche, 2017, p.391)

Transmission+Interference: A Synthesis of Objects, Noise, and Workshops

This closing section of the thesis brings to resolution the threads of objects, machines, noise, and collective making that have been detailed in the previous chapters. The aim here is to point towards how the knowledge emerging from this practice-as-research project contributes to new knowledge in the field. The noise of *transmission+interference* in its sonic output, its processes of making, and its objects and machines works effectively in order to open up certain theories and practices that the research engages with.

The practice-as-research suggests that there are new ways of viewing information transmission that result in a new materialist / machine-oriented re-visiting of Shannon and Weaver's influential mathematical theory of communication (1948). As mentioned in Chapter 3, their theory always points to the position of noise as something that is directly interfering from the outside of objects, however, to follow the vitalism of new materialism there are flows of noise and information within the objects of communication that also contribute to the efficacy of transmission. Each of the stages of the communication theory have endo-relations, an internal resonance that is in excess of the message and they are also not simply passive receivers in a linear chain of events. The theory of communication can be disrupted through following the discourse of this thesis and, in particular, the *prehensions* coming from Whitehead where emphasis is moved away from simply that an object receives information towards *how* that object receives information as well as what it

will then do with that information. As Isabelle Stengers notes, ‘no cause, even God as a cause, has the power to define how it will cause. Nothing has the power to determine how it will matter for others.’ (2009, p. 40) A *transmission+interference* influenced diagram of communication would develop more along the lines of an assemblage of communication built around multi-directional feelings in-between objects. Developing an assemblage of communication would be inspired through the scores of a figure who has existed at the fringes of this thesis, despite being introduced as a central influence from the start - John Cage. The image of his *Fontana Mix* (1958) (Fig. 76) captures the noise of communication within *transmission+interference* and added to this is the assemblage nature of this image. It is made from layers of clear acetate, one with wandering lines, another with dots, another with a straight line, and finally a rectangular grid. These can be moved and removed, reordered and adjusted to reveal new powers from new connections between each object. Noise is not imposed from outside the assemblage, it is there on the page(s), in the dots and lines and their connections and intra-actions.

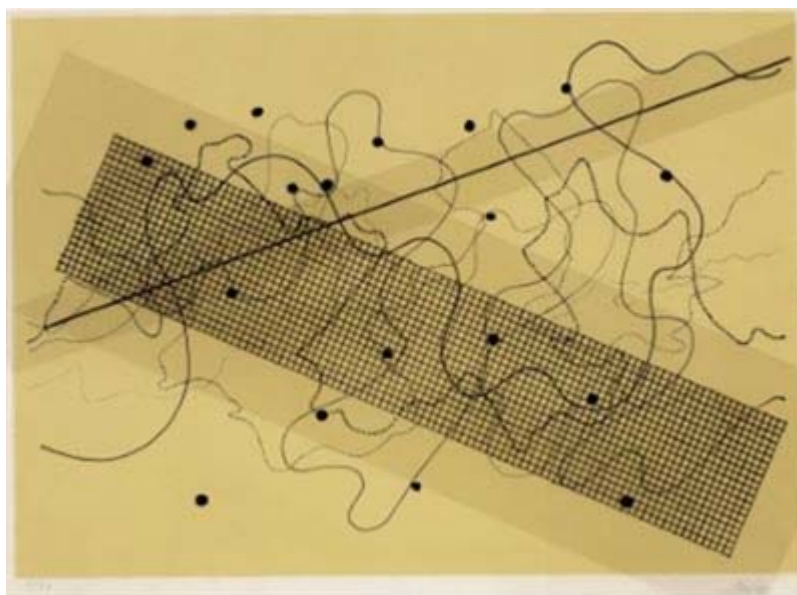

(Fig. 76. Fontana Mix, Cage, 1958)

This practice-as-research also offers a new way to explore collective making practices that can build on the DIY and DIWO models into a greater posthumanist world. In fact, following Bogost's claim that '[p]osthumanism [...] is not posthumanist enough.' (2011, p. 8) there is an encouragement from within OOO and new materialism to push for the entanglements of new worldings suggested by Haraway. A new collective making manifesto should borrow from the language of Deleuze and Guattari, Barad, Bennett, Bryant, Haraway and others mentioned in this thesis in order to directly engage in the noisy, dirty, fleshy, vibrant assemblages that are already part of the collective making experience but now are experienced within an ontologically flattened environment.

Throughout the thesis the term wandering has emerged as a significant method for working creatively with noise, sound, and technological objects and machines. Whether it is through Pierre Schaeffer's wandering and stumbling through the sound studio or the flows of noise that wander across the workshop, in-between objects and machines or the motions of those objects and machines wandering through workshops and performances there is a slowly meandering method of feeling and affecting that is influenced by the resonance of noise. It is connected to the critical making approach of Ratto where the end goal is not any specific object or machine but instead a wandering through a concept of noise. The projects *Wandering Snail* (2014), mentioned in Chapter 3, and *Noisy Embryos* (2016) by RADIX (Robinson, Rundle, and Strang) emerge here to suggest there is a hidden power in the act of wandering. The central machine of that project, the snail (*Radix balthica*), is

wandering the earth through acts of feeling the resonance of affecting fields through its body and resonant shell. It is shifting north according to the affecting nature of climate change, the nature of its wandering epigenetically shared amongst its species, not moving towards a specific location but on the move in response to the feeling of particular affects. The objects and machines of *transmission+interference* are too wandering in a similar nature. To operate with noise in

transmission+interference is to Wander-With-Others (WWO) and this requires:

1. a structural opening up to any flows, especially flows of differences in-between coming from diffraction and transduction
2. shifting black noise objects into focus - actively bringing in peripheral objects to the field of material consciousness
3. messy assemblages, not networks, that allow for breakages, new bodies / objects / machines, new lines of flight
4. co-worldings inspired by dust and non-human intra-actions
5. flattening of all hierarchies to avoid any overcoding between objects and machines

This WWO method is positioned as another machine entangled with the DIWO manifesto, not as a replacement. The importance of wandering is captured in the image of John Cage's *Fontana Mix* (1958) (Fig. 76) which is a well known score that offers chance encounters of sounds through the layered images of randomly placed dots, rectangular grid, straight line, and wandering curved lines. This score of indeterminacy is central to Cage's approach to music and sound that became well known because of the elements of chance and randomness that emerged from it.

What is most striking in the image is the wandering curved lines that seem to flow with wandering energy between dots, intersecting other lines and grids. The wandering curved lines are the noisiest objects on the score. The hidden power of wandering within Cage was masked by much discourse around him focusing on chance, randomness, and silence.

Throughout the practice of this research affective wanderings are produced primarily due to two concepts emerging from Barad's concept of *agential realism: diffractions and intra-actions* (2007). Degrees of difference exist between all of the following objects involved in the practice: objects, humans, humans and objects, workshops, machines, light patterns, sound waves, and disciplines. The practice wanders amongst the difference between these objects and machines and added to the diffractive difference is the sonic influenced difference of *transduction* - this shifts the dominance of the visual world (diffraction) to intra-act with the energies propagating from sonic waves (transduction). *Transmission+interference* is what emerges when diffraction and transduction differentially intra-act, a hidden agency of sound (intra-)acting with(in) light that is only made possible through open, noisy workshop environments that allow for the entanglement of these differences that matter (Barad, 2007).

Noisy wandering lines, Blamey's mess of copper wire (*Forage*, 2012), Howse's laser pointer crossing a surface, a wandering snail, vibrations of dust across a surface (*transmission+interference*), and the many projects detailed within this thesis are noisily wandering through their worlds, forever entangled with(in) each other.

‘All of nature in its awful vastness and incomprehensible complexity is in the end interrelated - worlds within worlds within worlds: the seen and the unseen - the physical and the immaterial are all connected - each exerting influence on the next - bound, as it were, by chains of analogy - magnetic chains. Every decision, every action mirrors, ripples, reflects and echoes throughout the whole of creation. The world is indeed bound with secret knots.’ (Worth, 1996)

This practice-led research contributes to the development of collaborative practices informed by DIWO through a methodology of wandering. This new methodology has emerged through the synthesis between the noisy making practices of *transmission+interference* and the theoretical discourse introduced in this written thesis. Through expanding upon the existing DIWO manifesto that is linked to networks with the use of assemblages and assemblage theory, the act of *wandering-with-others* is established as a more entangled world built upon the theories of Bryant’s ‘worlds’ and Deleuze and Guattari’s ‘refrain’. This research extends Bryant’s ‘worlds’ with the discourse of the ‘refrain’ with a greater understanding of the dynamic interplay between territories and the materials and machines that form those territories. This methodology is a practical outcome of both the practice and theory of this research offering a new platform for creative practitioners to engage with each other *with* materials.

Whilst the research presented here has had a strong focus on sound and sonic arts, the impact of the research has the potential to reach further across the arts and various maker practices emerging from the field of DIY. The inclusion of discourse

from writers such as Timothy Morton and Amitav Ghosh suggest a potential impact upon the thinking and acting around environmental and climate based issues. There is a resonance with New Materialism here through the understanding of the power of affect hidden within machines that is only realized through material intra-actions. As unstable climate conditions continue to disrupt across the world, the likelihood of new materialist connections occurring is increased with unknown results. The speculative wanderings within shared, open workshops offer a platform for developing new insights and discourse around this problem.

References

List of Artworks

- Barry, R. (1969). *January 5-31, 1969*. [Radio Waves]
- Blamey, P. (2012). *Forage*. [Sound and Object]
- Cage, J. (1951). *Imaginary Landscape No.4*. [Sound]
- Cage, J. (1952). *4'33"*. [Sound]
- Cage, J. (1958). *Fontana Mix*. [Sound and Text]
- Cage, J. (1960). *Cartridge music*. [Object and Sound]. New York, NY: Henmar Press (Edition Peters, no. 6703)
- Henke, R. (2016). *Fragile Territories*. [Laser Light and Sound].
- Holzer, D. (2007). *Tonewheels*. [Object, Sound, and Light]
- Howse, M. (2014). *Laser Playback Head*. [Laser and Photocell].
- Howse, M. and Miyazaki, S. (2010). *Detektors*. [Electronic Circuit].
- Howse, M. (2012). *Earth Code*. [Electronic Circuit and Earth].
- Marclay, C. (1985). *Record Without a Cover*. [Record Vinyl]
- McCall, A. (1973). *Line Describing a Cone*. [Light]
- Neuhaus, M. (1967). *Drive in Music*. [Sound]
- Paik, N. J. (1965). *Zen For Film*. [Film Projection]
- Prior, A. and Strang, D. (2014). *Hotwire~*. [Artist Collective].
- Robinson, D, Rundle, S. and Strang, D. (2014). *Wandering Snail*. [Radix balthica, Sound, Text, Light].
- Robinson, D, Rundle, S. and Strang, D. (2016). *Noisy Embryos*. [Video].
- Richards, J. (2022). *Sudophone (4th ed.)* [Object and Sound].
- Strang, D. (2014). *Light Entropy*. [Ice, Light and Sound].

Strang, D. and Van Uffelen, V. (2008). *transmission+interference*. [Light, Sound and Object].

Strang, D. And Van Uffelen, V. (2016). *transmission+interference: digital synesthesia*. [Light, Sound and Object].

Strang, D, Van Uffelen, V. And Von Jungenfeld, R. (2016). *Stick Charts*. [Object].

Tone, Y. (1997). *Solo for Wounded CD*. [Audio CD]. New York: Tzadik.

Tudor, D. (1968). *Rainforest IV*. [Sound and Object]

List of Texts

Amato, J. A. (2001). *Dust: A history of the Small & the Invisible*. University of California Press.

Arendt, H. (2018). *The Human Condition*. University of Chicago Press: Chicago and London.

Bachelard, G. (2016). *The Dialectic of Duration*. Rowman and Littlefield International: London and New York.

Banks, J. (2012). *Rorschach Audio: Art and Illusion for Sound*. Strange Attractor Press.

Barad, K. (2007). *Meeting the Universe Halfway: Quantum Physics and the entanglement of Matter and Meaning*. North Carolina: Duke University Press.

Bardini, T. (2011). *Junkware*. University of Minnesota Press: Minneapolis and London.

Barthes, R. (2000). *Camera Lucida*. Vintage Classics.

Bennett, J. (2010a). *Vibrant Matter: A Political Ecology of Things*. Durham, NC: Duke University Press.

- Bennett, J. (2010b). *A Vitalist Stopover on the Way to a New Materialism*, in Coole, D. And Frost, S. (ed.) *New Materialisms: Ontology, Agency, and Politics*. Duke University Press: Durham and London, pp. 47 - 69
- Bennett, J. (2015). *Systems and Things: On Vital Materialism*, in Grusin, R (ed.) *The Nonhuman Turn*. University of Minnesota Press, pp. 223 - 239
- Bogost, I. (2012). *Alien Phenomenology or What It's Like to be a Thing*. Minneapolis: University of Minnesota Press.
- Bowers, J. et al. (2016). *One Knob to Rule Them All: Reductionist Interfaces for Expansionist Research*. In *Proc. NIME 2016*.
- Bridle, J. (2018). *New Dark Age: Technology and the End of the Future*. Verso.
- Bryant, L. (2011). *The Democracy of Objects*. Ann Arbor: Open Humanities Press.
- Bryant, L. (2014). *Onto-Cartography: An Ontology of Machines and Media*. Edinburgh University Press.
- Cage, J. (1968). *Silence: Lectures and Writing*. Marion Boyars: London
- Capra, F. and Luisi, P. L. (2014). *The Systems View of Life: A Unifying Vision*. Cambridge University Press.
- Cascone, K. (2000). *The Aesthetics of Failure: 'Post-Digital' tendencies in contemporary computer music*. *Computer Music Journal* 24(4): 12-18.
- Catlow, R. And Garrett, M. (2019). *DIWO to DAOWO: Rehashing Proprietorial Dominance of Art Practice*, in O' Hara, S. and Bradbury, V. *Art Hack Practice: Critical Intersections of Art, Innovation and the Maker Movement*. CRC Press, UK, pp. 63 - 79.
- Collins, N. (2009). *Handmade Electronic Music: The Art of Hardware Hacking*. Routledge: New York and London.

- Combes, M. (2013). *Gilbert Simondon and the Philosophy of the Transindividual*. MIT Press
- Deleuze, G. (1993). *The Fold*. Minneapolis: University of Minnesota Press.
- Deleuze, G. (2004). *Difference and Repetition*. Continuum Impacts.
- Deleuze, G and Guattari, F. (1983). *Anti-Oedipus: Capitalism and Schizophrenia*. University of Minnesota Press: Minneapolis.
- Deleuze, G. and Guattari, F. (1987). *A Thousand Plateaus*. Continuum.
- DeLanda, M. (2011). *Philosophy and simulation*. London: Continuum.
- DeLanda, M. (2016). *Assemblage Theory*. Edinburgh University Press.
- Druckrey, T. (1999). *Ars Electronica: Facing the Future*. MIT Press.
- Eco, U. (2006). *The Poetics of the Open Work*, in Cox, C. And Warner, D. (ed.) *Audio Culture: Readings in Modern Music*. Continuum: New York and London, pp. 167 - 175
- Ghosh, A. (2016). *The Great Derangement: Climate Change and the Unthinkable*. University of Chicago Press: Chicago and London.
- Gleick, J. (2011). *The Information*. New York: Pantheon Books.
- Grosz, E. (2005). 'Bergson, Deleuze and the Becoming of Unbecoming', *Parallax*, 11(2), pp. 4 - 13.
- Grosz, E. (2008). *Chaos, Territory, Art: Deleuze and the Framing of the Earth*. Columbia University Press: New York.
- Grosz, E. (2017). *The Incorporeal: Ontology, Ethics, and the Limits of Materialism*. Columbia University Press: New York.
- Guattari, F. (1977). *La Revolution Moléculaire*, in Kogawa, T. *A Radio Manifest*, Acoustic Space Journal 7 (2008).

- Hainge, G. (2013). *Noise Matters: Towards an Ontology of Noise*. Bloomsbury.
- Haraway, D. (2016). *Staying with the Trouble: Making Kin in the Chthulucene*. Duke University Press.
- Harman, G. (2005). *Guerilla Metaphysics: Phenomenology and the Carpentry of Things*. Chicago: Open Court.
- Harman, G. (2016). *Immaterialism*. Polity.
- Harman, G. (2018). *Object-Oriented Ontology: A New Theory of Everything*. Pelican Books.
- Hayles, N. K. (2017). *Unthought: The Power of the Cognitive Unconscious*. University of Chicago Press.
- Hess, F. and Schulz, B. (2001). *Light as Air*. Stadtgalerie Saarbrücken.
- Howse, M. (2008). *The Aether and its Double*, in Šmite, R., Medosch, A. and Siliņa, D. (2008). *Spectropia*. Liepāja, Latvia: MPLab, Art Research Lab of Liepāja, p. 160.
- Ikoniadou, E. (2014). *The Rhythmic Event: Art, Media and the Sonic*. MIT Press.
- Ingold, T. (2013). *Making: Anthropology, Archaeology, Art and Architecture*. Routledge: London and New York
- Jun, Y. (2014). *The Laundromat by the Sea*. Available at: <https://yanjun.org/archives/1282> (Accessed: 14 February 2023)
- Kahn, D. (2001). *Noise, water, meat*. Cambridge, Mass.: MIT.
- Kahn, D. (2013). *Earth Sound Earth Signal*. Berkeley: University of California Press.
- Kahn, D. (2019). *Energy Field Performance: Peter Blamey*, in Kahn, D. (ed.) *Energies in the Arts*. MIT Press: Cambridge and London, pp. 397 - 421.
- Kelly, C. (2009). *Cracked Media: The Sound of Malfunction*. MIT Press.

- Kelly, C. (2021). 'Dirt(y) media: Dirt in ecological media art practices', *European Journal of Cultural Studies*, 0(0).
- Kogawa, T. (2006). *A Micro Radio Manifesto*. Available at: <http://anarchy.translocal.jp/radio/micro/index.html> (Accessed: 27 January 2023).
- LaBelle, B. (2006). *Background Noise: Perspectives on Sound Art*. New York: Continuum.
- Levi-Strauss, C. (1966). *The Savage Mind*. University of Chicago Press.
- Lucretius. (2007). *The Nature of Things*. Penguin Classics.
- Mackenzie, A. (2002). *Transductions: Bodies and Machines at Speed*. Continuum: London / New York.
- Manning, E. (2015) *Artfulness*, in Grusin, R (ed.) *The Nonhuman Turn*. University of Minnesota Press, pp. 45 - 79
- Mansoux, A. and Valk, M. (2008). *FLOSS+ART*. OpenMute.
- Marder, M. (2016) *Dust*. New York: Bloomsbury Academic.
- Massumi, B. (2002). *Parables For The Virtual: Movement, Affect, Sensation*. Duke University Press.
- Maturana, H. and Varela, F. (1992). *The tree of knowledge*. Boston: Shambhala.
- Meillassoux, Q. (2015). *After Finitude: An Essay on the Necessity of Contingency*. Bloomsbury Academic.
- Moholy-Nagy, L. (1922). *Production-Reproduction: Potentialities of the Phonograph*, in Cox, C. And Warner, D. (ed.) *Audio Culture: Readings in Modern Music*. Continuum: New York and London, pp. 331- 333
- Morton, T. (2013). *Hyperobjects: Philosophy and Ecology after the End of the World*. University of Minnesota Press.

- NASA. (1972). *Tempest: A Signal Problem*.
- Negarestani, R. (2008). *Cyclonopedia*. Melbourne: Re.press.
- Nietzsche, F. (2017). *The Will to Power*. Penguin Classics
- Parikka, J. (2012). *What is Media Archaeology*. Polity.
- Parikka, J. (2015). *A Geology of Media*. University of Minnesota Press: Minneapolis and London.
- Pickering, A. (1995). *The Mangle of Practice*. University of Chicago Press: Chicago and London
- Ratto, M. (2011). 'Critical Making: Conceptual and Material Studies in Technology and Social Life', *The Information Society*, 27, pp. 252 - 260.
- Richards, J. (2018). *Speculative Sound Circuits*. In *Proc. EVA Copenhagen 2018*.
- Sennett, R. (2008). *The Craftsman*. Penguin Books
- Sennett, R. (2012). *Together: The Rituals, Pleasures & Politics of Cooperation*. Penguin Books.
- Serres, M. (1995). *Genesis*. Ann Arbor: University of Michigan Press.
- Serres, M. (2007). *The Parasite*. University of Minnesota Press.
- Serres, M. (2018). *The Birth of Physics*. Rowman and Littlefield International: London and New York.
- Shaviri, S. (2014). *The Universe of Things: On Speculative Realism*. University of Minnesota Press. Minneapolis and London.
- Simondon, G. (2017). *On the Mode of Existence of Technical Objects*. University of Minnesota Press: Minneapolis and London.
- Spinoza, B. (1996). *Ethics*. Penguin Classics.

Stengers, I. (2009). *Thinking with Deleuze and Whitehead: A Double Test*, in Shaviro, S. (2014). *The Universe of Things: On Speculative Realism*. University of Minnesota Press. Minneapolis and London, p. 38.

Uexküll, J. V. (2010). *A Foray into the Worlds of Animals and Humans: With a Theory of Meaning*. University of Minnesota Press: Minneapolis and London.

Voegelin, S. (2010). *Listening to Noise and Silence: Towards a Philosophy of Sound Art*. Continuum: New York and London.

Weibel, P. (1999). *The Noise of the Observer*, in Druckery, T. (ed.) *Ars Electronica: Facing the Future*. MIT Press: Cambridge and London, pp. 140 - 148.

Whitehead, A. N. (1978). *Process and Reality*. New York: Macmillan.

Wilson, S. (2002). *Information Arts: Intersections of Art, Science, and Technology*. MIT Press.

Worth, V. (1996). *The World is Bound with Secret Knots from Magneticum Naturae Regnum*. Available at: <https://www.mjt.org/pages/exhibits/kircher/magnes.htm> (accessed 27 January 2023).

Bibliography

- Althusser, L. (2006). *Philosophy of the Encounter: Later Writings, 1978 - 1987*. New York: Verso.
- Bateson, G. (2000). *Steps to an Ecology of the Mind*. University of Chicago Press.
- Benjamin, W. (1999). *Illuminations*. Pimlico.
- Bergson, H., Paul, N. and Palmer, W. (1912). *Matter and memory*. London: G. Allen & Co.
- Bergson, H. and Mitchell, A. (1944). *Creative evolution*. New York: Modern library.
- Bohm, D. (1976). *Fragmentation and Wholeness*. Jerusalem: Van Leer Jerusalem Foundation.
- Clough, P. (2000). *Autoaffection*. Minneapolis: University of Minnesota Press.
- Clough, P. and Halley, J. (2007). *The affective turn*. Durham: Duke University Press.
- De Certeau, M. (1984). *The Practice of Everyday Life*. Berkeley: University of California Press.
- Deleuze, G. (1990). *The Logic of Sense*. Continuum Impacts.
- DeLanda, M. (2002). *Intensive Science and Virtual Philosophy*. London: Continuum.
- DeLanda, M. (2006). *A new philosophy of society*. London: Continuum.
- Descartes, R. (2006 / 1637). *Discourse on Method*. New York: Oxford University Press.
- Fuller, M. (2008). *Software Studies \ A Lexicon*. MIT Press.
- Fuller, M. (2007). *Media Ecologies: Materialist Energies in Art and Technoculture*. MIT Press.
- Gell, A. (1998). *Art and Agency: An Anthropological Theory*. Oxford: Clarendon

Goodman, S. (2010). *Sonic Warfare: Sound, Affect and the Ecology of Fear*. MIT Press.

Gleick, J. (1987). *Chaos*. New York, N.Y., U.S.A.: Viking.

Guattari, F. (1989). *Schizoanalytic Cartographies*. Bloomsbury.

Guattari, F. (2011). *The Machinic Unconscious*. Los Angeles, CA: Semiotext(e).

Hacking, I. (1998). *Mad Travellers: Reflections on the Reality of Transient Mental Diseases*. Cambridge, MA: Harvard University Press.

Hall, S. (1973). *Encoding and Decoding in the Television Discourse*. Birmingham: Centre for Contemporary Cultural Studies.

Harman, G. (2010). *Towards Speculative Realism: Essays and Lectures*. Zero Books.

Harman, G. (2002). *Tool-Being: Heidegger and the Metaphysics of Objects*. Chicago: Open Court.

Haraway, D. J. (1991). *Simians, Cyborgs, and Women: The Reinvention of Nature*. New York: Routledge.

Heidegger, M. (1962) *Being and Time*. Blackwell.

Howse, M. (2006). XXXXX. Berlin: XXXXX.

Ingold, T. (2011). *Being alive*. London: Routledge.

Ingold, T. (2007). *Lines*. London: Routledge.

Jensen, E. and LaBelle, B. (2007). *Radio Territories*. Errant Bodies Press.

Kittler, F. (1986). *Gramophone, Film, Typewriter*. Stanford University Press.

LaBelle, B. (2010). *Acoustic Territories / Sound Culture and Everyday Life*. New York: Continuum.

LaBelle, B. (2004). *Site Specific Sound*. Errant Bodies Press.

Langer, S. K. (1953). *Feeling and Form: A Theory of Art Developed from Philosophy in a New Key*. London: Routledge.

Latour, B. (2005). *Reassembling the social*. Oxford: Oxford University Press.

Lefebvre, H. (2004). *Rhythmanalysis: Space, Time and Everyday Life*. London: Continuum.

Lem, S. (1964). *SUMMA Technologiae*. University of Minnesota Press.

Luhmann, N. (1990). *Essay on Self-Reference*. New York: Columbia University Press.

Manning, E. and Massumi, B. (2014). *Thought in the Act: Passages in the Ecology of Experience*. University of Minnesota Press.

Martinho, C. and LaBelle, B. (2011). *Site of Sound #2: Of Architecture and the Ear*. Errant Bodies Press.

Massumi, B. (2011). *Semblance and event*. Cambridge, Mass.: MIT Press.

Mattin and Iles, A. (2009). *Noise and Capitalism*. Arteleku Audiolab.

McLuhan, M. (1994). *Understanding Media: The Extensions of Man*. Toronto: University of Toronto Press.

Merleau-Ponty, M. (1945). *Phenomenology of Perception*. Routledge.

Morton, T. (2010). *The ecological thought*. Cambridge, Mass.: Harvard University Press.

Prigogine, I. and Stengers, I. (1997). *The end of certainty*. New York: Free Press.

Prigogine, I., Stengers, I. and Prigogine, I. (1984). *Order out of chaos*. Toronto: Bantam Books.

Pynchon, T. (1973). *Gravity's rainbow*. New York: Viking Press.

Schneider, E. D. and Sagan, D. (2006). *Into the Cool*. University of Chicago Press.

Sha, X, W. (2013). *Poiesis and Enchantment in Topological Matter*. MIT Press.

- Šmite, R., Medosch, A. and Siliņa, D. (2008). *Spectropia*. Liepāja, Latvia: MPLab, Art Research Lab of Liepāja.
- Siliņa, D., Buckmaster, R. and Vēbere, L. (2012). *Techno-ecologies*. Liepāja, Latvia: MPLab, Art Research Lab of Liepāja.
- Šmite, R., Medosch, A. and Šmits, R. (2014). *Techno-ecologies 2*. Liepāja, Latvia: MPLab, Art Research Lab of Liepāja.
- Stengers, I. (2004). *A Constructivist Reading of Process and Reality*. London: Goldsmiths.
- Stiegler, B. (1998). *Technics and Time, 1: The Fault of Epimetheus*. Stanford: Stanford University Press.
- Thom, R. (1983). *Mathematical Models of Morphogenesis*. Chichester, UK: Ellis Horwood.
- Thom, R. (1989). *Structural Stability and Morphogenesis: An Outline of a General Theory of Models*. Reading, Mass: Addison-Wesley.
- Thrift, N. (2008). *Non-Representational Theory: Space | Politics | Affect*. London: Routledge.
- Varela, F. J., Thompson, E. & Rosch, E. (1991). *The Embodied Mind: Cognitive Science and Human Experience*. Cambridge, MA: MIT Press.
- Virilio, P. (1995). *The Art of the Motor*. University of Minnesota Press.
- Virilio, P. (1997). *Open Sky*. Verso.
- Voegelin, S. (2010). *Listening to Noise and Silence*. Continuum.
- Whitehead, A. N. (1920). *The Concept of Nature*. Cambridge: Cambridge University Press.
- Whitehead, A. N. (1968). *Modes of Thought*. New York: Free Press.

Appendix

Information Sheet

Project: *Territories of Noise*

Name of Researcher: *David Strang (PhD student – Plymouth University)*

Name of PhD Supervisor: *Dr. Lee Miller*

Email: *lee.miller@plymouth.ac.uk*

What is this project about?

The intention of my thesis is to discover new creative potential through investigating the topology and movement of information flow within systems of light and sound. The research project is practice as research and will involve the creation of certain devices / instruments for the purpose of performance and / or installation. The practice will explore the creative characteristics of hacking and appropriating tools through an open and shared making process (workshops) - Doing It Together (D.I.T). By encouraging noise to flow and leak across machinic territories there is an increased potential for generating unpredictable devices for sound and light performance. To then understand the potential movement of noise within these devices increases the creative control. The control here is a playful aspect, as the project will be exploring ways in which noise is used to create borders of territories, hide information and enhance the transmission of signals. The making process of the research will explore the power of the tool / object and move away from the anthropocentric view to begin to place the creativity of the components of these tools / objects as separate from that of the user / maker. The workshops are used as a method of collective or shared knowledge

production through processes of actively making and engaging with objects and materials. The aim of the workshops is to develop new tools for performance and/or installation that will be used by the researcher and the workshop participants.

Risks and benefits

The risks involved in participating in the project are very low and may include the handling of electronics and soldering equipment. The benefits of participating are developing new skills in electronics and sound and becoming part of an active network of practitioners.

Right to Withdraw

All participation is voluntary and neither refusal nor discontinued participation has any negative effects. You have the right to withdraw at any time up to 7 days after involvement in the research.

Confidentiality

All collected data will be kept anonymous and only used for the purposes identified above. Your responses will be anonymised; no names of participants will be included at any point. The data collected during the project will be stored in accordance with the following statement: “The University’s research ethics policy states that data should be securely held for a minimum of ten years after the completion of the research project.”

Debriefing

If you would like to know about the outcomes of the research then you can contact the researcher directly using the contact details above.

Planned Outputs

The results will be used for the purposes of both the written thesis and practical workshops / live performance.

Further information

If you have specific questions please contact me via the contact details listed above.

Participant Information Sheet

Title of Project: Territories of Noise

Name of Researcher: David Strang (PhD student – Plymouth University)

Name of PhD Supervisor: Dr. Lee Miller

Email: lee.miller@plymouth.ac.uk

I have received information about the Territories of Noise project and have had the opportunity to ask David Strang (Researcher) any questions leading up to my involvement. I understand that my participation in this research is voluntary and that I may withdraw at any time up to 7 days after my involvement.

I am aware that I may be handling electronics and soldering equipment with the appropriate level of safety supplied by the researcher. I understand that my involvement might include an interview and that photographs, video and sound recordings can be taken during my time involved in the research. My name will not be used to identify my comments or work in the study. The recorded material will be used as documentation for the project (providing evidence of what took place) and may be used to publicise future workshops and performances by the researcher and may be transcribed for the purposes of a written thesis.

The university's research ethics policy states that data should be securely held for a minimum of ten years after the completion of the research project. Electronic data will be stored on password-protected computers or laptops and individual files and/or discs must be encrypted. Hard copies of data must be stored in locked filing cabinets and disposed of securely when no longer required.

I agree that any work I make during the workshop may be used in future within this research project by the researcher. If I have any concerns or complaints about the way the research has been conducted I can contact the researcher directly or contact the Administrative Assistant (Research) (artsresearchethics@plymouth.ac.uk).

I understand that the data collected from my participation will be used for a PhD thesis and possibly other published studies and I consent for it to be used in that manner.

Bottom of Form