

2020

Combined Heating and Power: Control Documentation and Efficiency Measurement

Bebbington, D.

Bebbington, D. (2020) 'Combined Heating and Power: Control Documentation and Efficiency Measurement', The Plymouth Student Scientist, 13(1), p. 112-142.

<http://hdl.handle.net/10026.1/16508>

The Plymouth Student Scientist
University of Plymouth

All content in PEARL is protected by copyright law. Author manuscripts are made available in accordance with publisher policies. Please cite only the published version using the details provided on the item record or document. In the absence of an open licence (e.g. Creative Commons), permissions for further reuse of content should be sought from the publisher or author.

Combined Heating and Power: Control Documentation and Efficiency Measurement

Daniel Bebbington

Project Advisor: Dr Daniel C. Hatton School of Engineering, University of Plymouth, Drake Circus, Plymouth, UK. PL4 8AA

Abstract

The University of Plymouth has an experimental Combined Heating and Power (CHP) plant with a poorly documented bespoke space heating loop (SHL), which has led to the existence of some controls with unknown purposes. This research seeks to produce complete documentation for the CHP through experimental methods. This includes taking visual inspections, Thermocouple (TC) temperature measurements, Transit Time Ultrasonic Flow Meter (TTUF) volumetric flow measurements, and Electronic Control Unit (ECL) temperature measurements.

The overall thermal efficiency (η_{th}) measurement methodology will then be assessed as to whether or not it is a suitable protocol for compliance to EU Boiler Efficiency Directive 92/42EEC, and ISO17025: General requirements for the competence of testing and calibration laboratories. The CHP plant was successfully reverse engineered through experimentation to produce documentation of the controls in the form of a schematic. A labelling system was established creating reference between the actual CHP system, and the schematic.

The efficiency of the CHP was determined using three different judgements of what is useful space heating. This was found to have a major contribution to the result. The values of η_{th} varied from 92.3% to 57.2% for assuming all heating power produce by the CHP is useful, to assuming that heat transfer in distribution is to not useful space. A protocol was established to closer meet the EU Directive, however complete compliance would prove challenging. Some areas of priority were highlighted to adhere closer to ISO17025, with certain calibrations and the tracing of systematic errors helping to closer meet the terms of the standard.

Key Words: Combined Heating and Power, Space Heating, EU Directive 92/42/EEC, ISO17025.

Introduction

A combined heating and power (CHP) system has a generator used to meet an electrical power demand, whilst also capturing the heat rejection, (Horlock, 1987). Heat would otherwise be wasted in a typical generator, so a CHP is known as an energy conservation system, (Abusoglu and Kanoglu, 2008). The reclaimed heat can be used to feed space heating loops (SHLs), absorption cooling or provide domestic hot water (DHW) (Nguyen, Slawnwhite and Boulama, 2010). A typical CHP system can be found in SAV Systems (2019)..

Making efficient use of energy is becoming increasingly important. Renewable sources are on the rise in the UK, (Department for Business, Energy & Industrial Strategy, 2018). The government have set a target of 15% of renewable energy sources by 2020, however this would still leave 85% of total energy generation produced by either nuclear energy or fossil fuels, (Department of Energy & Climate Change, 2011).

This high dependency on fossil fuels leaves CHP systems as a possible solution for an improved use of energy (Thomas, 2008), particularly as “more than 50% of the energy that is used in the world is wasted as heat”, (Mahmoudi, Fazli and Morad, 2018). A fossil fuel to electricity efficiency of typical power plant is in the order of 36%, compared to the potential efficiency of a CHP system of 95%, (Nguyen, Doherty and Riffat, 2001). However, this comparison may not be entirely fair, as this assumes for CHPs that all the heat transfer to the surroundings throughout the distribution is to useful space.

The University of Plymouth has an experimental CHP plant for lab classes. There is a well-documented Power Unit (PU) with a natural gas fuelled Internal Combustion Engine (ICE), (EC Power, 2007). It also has a bespoke SHL, which is poorly documented. This has led to the existence of certain controls with unknown purposes. This research will seek to produce a complete documentation of the CHP plant's bespoke SHL.

It is important to document the system controls not only for safety purposes, but also to enable repeatable, and reliable running conditions. This is necessary to meet the requirements of laboratory calibration standards such as ISO 17025, (BSI Standards Publication, 2017). It also results in being able to run at an optimum efficiency to deliver cost savings and compliance with environmental legislation such as the EU Boiler Efficiency Directive 92/42/EEC (Council of the European Union, 1992).

Research Aims

- Produce an effective method for reverse engineering, and documenting, a CHP plant's controls system via experimentation.
- Increase the overall uptake in CHP plants by presenting a method of improvement to efficiency measurements.

Research Objectives

SMART (Specific, Measurable, Assignable, Realistic and Time-bound), objectives were set with an emphasis on the tasks being “realistic”, meaning that they can be completed given the resources available (Doran, 1981). These objectives outline the research, provide a useful progress tool and assist in working towards the completion of the research aims.

- Perform a visual inspection of the University of Plymouth's experimental micro CHP plant to produce a network diagram of the bespoke space heating loop.
- Reverse engineer the CHP plant through experimentation in order to complete a full schematic.
- Assess the overall thermal efficiency measurement methods of the CHP plant.
- Assess what may be required to bring the current efficiency measurement methods into a suitable protocol for a notified efficiency body under Annex III of EU Boiler Efficiency Directive 92/42/EEC.
- Assess what may be required to bring the efficiency measurement methodology into a closer compliance with ISO17025: General requirements for the competence of testing and calibration laboratories

Prioritisation of the objectives was completed with consideration of both the urgency and importance of the tasks (Claessens et al., 2010). The objectives are in this order as some require completion before others could begin. For example, the system needed to be visually inspected before a schematic could be produced, and, the overall efficiency needed to be assessed before discussing the required compliance with the EU Directive.

Literature Review

A review was completed iteratively with the aims and objectives to ensure a suitable level of literature to review and to ensure relevance to the research. It was necessary to read around the research topics to set it into context, to legitimate conclusions and to spot any gaps in the literature which have not been explore, (Blaxter, Hughes and Tight, 2013).

Combined Heating and Power

Taie et al. (2018) states that there is a current gap in the literature for “state of the art” micro CHP systems, therefore performed a study to create baseline data for a Honda ECOWILL micro CHP system with a maximum electrical power output of 1kW. Taie et al. (2018) performed a first, and second law analysis at device and component level. Whereby a first law of thermodynamics analysis uses the conservation of energy principle, and a second law of thermodynamics analysis uses the irreversibility entropy principle (Lee, 2010). It was identified that energy leaving the exhaust was negligible, suggesting efficient removal of heat, however it found that a large loss of energy was in the form of heat transfer from the generator system (Taie et al., 2018).

CHP systems were chosen as the area for study as it's expected to become a key feature in meeting future energy requirements. Areas of potential application include district heating systems and industries with a high heat demand (SATO et al., 2008). Only 6% of the UK's electricity is currently generated through the use of CHP plants, showing potential for major growth (Weber, 2010). Lund et al. (2014) describes a fourth major generation of district heating systems with biogas CHP technology being a key part.

Ultrasonic Flow Meters

Ultrasonic flow meters function on the working principle of measuring ultrasound waves, whereby ultrasound is soundwaves with frequencies above the human hearing, at approximately 20 kHz (Wilson, 2005). Types of non-invasive ultrasonic flow meters include: Transit Time Ultrasound Flowmeters (TTUF), Doppler Ultrasound Flow Meters (DUF) and Cross Correlation Ultrasonic Flowmeter (CCUF). TTUFs are considered to have higher accuracy and lower uncertainties than DUF and CCUF (Sanderson and Yeung, 2002).

Other types, such as a spool piece flow meter are considered to have less installation uncertainties than TTUF, however are more expensive to install and are generally better suited to longer term use (Mahadeva, Baker and Woodhouse, 2009). It is argued that along with the installation effects, the turbulence of the flow can also have an effect on the accuracies of ultrasonic flow meters (Carlander and Delsing, 2000). A TTUF was used in the experiments as it was available and suitable for the application as described in the Controls Documentation section.

A TTUF works on the principle of the time difference taken for the refracted soundwaves to travel between two transducers set at a certain distance apart. This transducer separation depends upon the pipe characteristics, as described by Sanderson and Yeung, 2002. The speed of sound is relative to the bulk of the fluid travelling in the pipe. The speed of sound varies for the material or fluid it is travelling through. Therefore, pipe material and fluid must be known. An ultrasonic sound wave is sent back and forth between transducers with the time differences recorded, and, using the known geometry of the equipment, a flowrate may be obtained. Uncertainties up to 0.6% can arise due to coupling of the transducers to the pipe surface and increases in the pipe temperature (Mahadeva, Baker and Woodhouse, 2009), and a systematic error of 1% can occur due to every 1mm of incorrect axial spacing of the transducers.

Thermocouples

A thermocouple (TC) is a temperature measuring device which works on the thermoelectric effect (Pollock, 1971). TCs function with two unlike metal conductors in a closed circuit producing a voltage difference known as the Seebeck effect (Michalski, Strak and Piasecka, 2017). This effect is temperature dependent. The signal is read by a voltmeter which converts the signal into a temperature read out. TCs are passive, meaning they do not require any external power. They are also simple in design which allows them to withstand vibrations, and small in size which enables them to respond quickly to changes in temperature (Wilson, 2005). However accuracy is a limitation, whereby systematic errors of less than $\pm 1^\circ\text{C}$ are difficult to achieve.

There are different types of TCs with differing attributes, including: temperature range, sensitivity, oxidation resistivity, and the Curie point (Bentley, 1998). Applications of TCs include: Ovens, Gas Turbines, and Diesel Engines (Bentley, 1998). Therefore, a CHP plant is a suitable application. TCs are standardised in the UK by the British Standards Institution (BSI) as BS EN 60584-3:2008. Widely used is a type K, with a temperature range of -200°C to 1350°C . These are relatively inexpensive and provide a reading with an accuracy of $\pm 1.5^\circ\text{C}$ (Bentley, 1998). This is a suitable choice for the investigation. Figures 4 and 17 in Control Documentation section show type K TC used during the investigation

According to Keltner and Beck (1983), the errors in surface mounted TCs may arise from imperfect contact, heat loss to the air, and thermal constriction effects, (Keltner and Beck, 1983). Ideally when measuring the temperatures of a liquid flowing in the pipe, TCs should be immersed within the fluid using a thermowell (Childs, 2001). However, the TCs used in the experimentation will be surface mounted to the pipes using tape to provide a temporary and inexpensive mounting solution. Therefore the TCs will need either sufficient insulation to limit heat transfer to the surroundings or account for the error with some sort of correction formula.

ISO 17025

The full title for BS EN ISO/IEC17025:2017 is “General requirements for the competence of testing and calibration laboratories”, (BSI Standards Publication, 2017). ISO17025 is an adaptation of ISO9000 quality management criteria (Sadikoglu and Temur, 2012), and describes the general requirements of competence, impartiality and consistency of laboratories, (BSI Standards Publication, 2017).

ISO17025 has certain requirements listed under categories of General, Structure, Resource, Process and Management System.

Under section 4, a key aspect of ISO17025 is the impartiality of the lab. It is defined in section 3 as “the presence of objectivity” (BSI Standards Publication, 2017). Therefore no relationships may have an effect on the lab management, and any risk of impartiality must be minimised. In terms of resources, the lab must have the following (BSI Standards Publication, 2017):

- Facilities to not affect the validity of results i.e. limit the contamination, temperature and vibrations.
- Impartial personnel who are competent and work in accordance to the management system, which meets the requirements of ISO9001 (BSI Standards Publication, 2015). This includes retaining, and updating records of education, qualification, training and technical knowledge for each personnel.
- Access to the necessary equipment such as measuring instruments, software, standards, and reference data.

Equipment must be calibrated when the measurements may affect the accuracy of the results. This includes documentation of regular calibrations checks, (BSI Standards Publication, 2017). The lab must also be able to perform metrological traceability. This is defined as “the property of a measurement result whereby the result can be related to a reference through a documented unbroken chain of calibrations, each contributing to the measurement uncertainty”, (BSI Standards Publication, 2017).

In terms of process requirements, the lab must perform activities with appropriate methods and measurement procedures, (BSI Standards Publication, 2017). The lab must also be able to validate the results, this can be achieved in a number of ways, (BSI Standards Publication, 2017):

- Systematically assess all the factors that may influence the results.
- Evaluate the measurement uncertainty using the theoretical principles and practical experience.

- Calibrate and remove bias with reference to standards.
- Interlaboratory comparisons.

Although intended to improve laboratory practices (Sadikoglu and Temur, 2012), found that statistically ISO17025 has a negative impact on laboratory performance when accreditation is desired for marketing purposes. This can be contributed to accreditation bodies not being strict and frequent enough with auditing (Sadikoglu and Temur, 2012).

EU Boiler Efficiency Directive

A Directive is a piece of legislation from the European Union (EU), which each EU country must implement into their own laws (Fretten and Miller, 2016). The full title is, “EU Council Directive 92/42/EEC of 21 May 1992 on efficiency requirements for new hot-water boilers fired with liquid or gaseous fuels” (Council of the European Union, 1992). In Article 2, a boiler is defined as “the combined boiler body-burner unit, designed to transmit to water the heat released from burning”. Article 1 defines that the Directive specifically applies to a boiler with a rated output (P_n) of 4kW or more up to 400kW (Council of the European Union, 1992).

In Article 2, the definition of the rated output (kW) is given as “the maximum calorific output laid down and guaranteed by the manufacturer as being deliverable during continuous operation while complying with the useful efficiency indicated by the manufacturer” (Council of the European Union, 1992). Where, useful efficiency (%) is defined as “the ratio between the heat output transmitted to the boiler water and the product of the net calorific value at constant fuel pressure and the consumption expressed as a quantity of fuel per unit time” (Council of the European Union, 1992).

The Directive details that boilers must adhere to a minimum useful efficiency (%) at the rated and part load output, at the average boiler-water temperature of 70°C and 50°C respectively. The average boiler temperature is defined as “the average of water temperatures at the entry and exit of the boiler” (Council of the European Union, 1992).

The use of a log function to calculate the required efficiency has complications. It is not clear what the log base is. This is important as it has an impact on the final numerical result. Secondly it is not overly obvious what the units ought to be when used in this formula, as $\log(\text{kW})$ is meaningless. The reader has to make the assumption that the rated power should be used with the unit in kW.

The boilers which obtain the mentioned useful efficiencies are awarded an energy performance label as per Article 6 “★”, and for each 3% above the requirement additional “★” are awarded as per Annex 2, (Council of the European Union, 1992). Furthermore, Article 6 states that any appliance on the market which has obtained the Directive’s requirement must be marked with “CE” in a visible and legible manner as per Annex 1 (Council of the European Union, 1992)

A notified body must attest that the boiler meets the requirements of the Directive. However, the notified bodies are often themselves manufacturers of boilers and space heating systems (Ec.europa.eu, 2019). The request requirements include the following from Annex 3 (Council of the European Union, 1992):

- Detail design drawings of the components and circuits.

- Any material to aid the understanding of operation.
- The solutions to meet the efficiency requirements.
- Calculations and examinations carried out and test reports.

Discussion

Problem Analysis

The University of Plymouth's experimental CHP plant is an XRGI 13G system produced by EC Power. The PU consists of a 2 Litre (L) natural gas ICE connected to an induction generator, (Wildi, 2000), see Figure 1. It produces a maximum electrical output (W_{elec}) of 13kW, and maximum thermal power output (W_{heat}) of 29kW (EC Power, 2007).

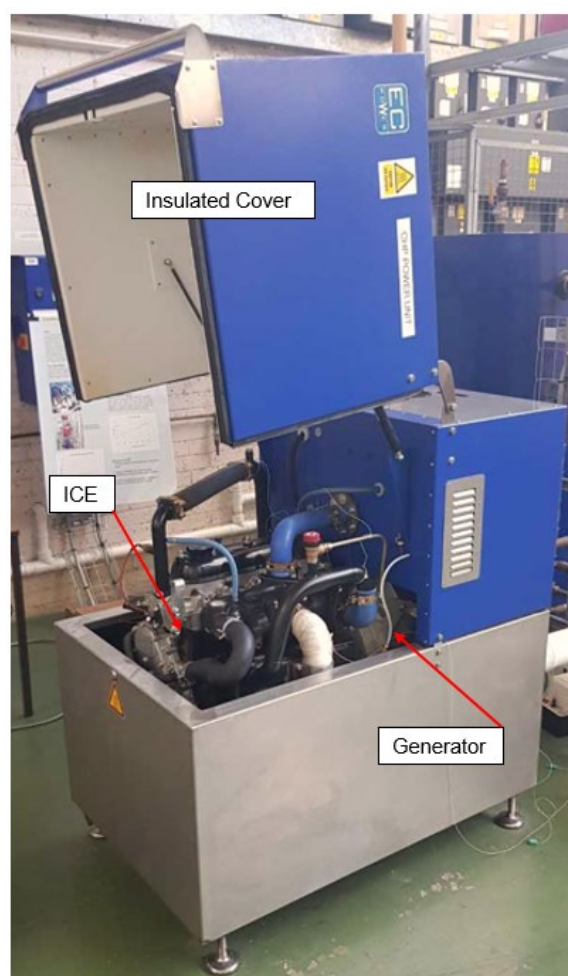

Figure 1: PU Diagram, (EC Power, 2007).

The PU coolant loop circulates through the generator heat exchanger (H/X), ICE exhaust H/X and the ICE. The coolant supply and return from the PU is fed to an external Heat Distribution unit, see Figure 2. This regulates the ICE temperature, whilst feeding the recovered heat to a SHL.



Figure 2: Heat Distribution Unit and Buffer Vessel

The Heat Distribution Unit is also connected in parallel to a 475L thermal Buffer Vessel (BV), see Figure 2. The BV absorbs fluctuations in SHL consumption, adding and removing heat as required (EC Power, 2007).

The performance data from EC Power states a total efficiency (η_{th}) up to 95% with a W_{elec} of more than 10kW (EC Power, 2007). However this η_{th} value should be taken with caution as it is possibly bias given that this value has come from the unit manufacturer.

The CHP plant has a lack of documentation on its bespoke SHL with no current instructions on its use, how to optimise its running or how accurate its η_{th} rating is.

Investigation and Methodology

To reverse engineer the CHP plant the task was split into two phases. Firstly to perform a visual inspection to produce a network diagram. Secondly, perform experimentation in order to develop a schematic. Then an understanding of the controls could be developed, and a discussion on the overall efficiency of the CHP plant could be developed. The methodology can then be assessed with respect to closer meeting the requirements of EU Directive 92/42/EEC and ISO17025.

Visual Inspection

The visual inspection located and recorded all components of the CHP system in a logical sequence. It was identified that the CHP plant had two circulation loops: one providing cooling to the PU, and a secondary SHL. Inspection began on the PU hot supply pipe. This was possible to identify from existing documentation. For consistency and removal of errors, any pipe junction was followed noting down each component as far as possible before returning to the main pipe.

A hand sketch was developed for the PU supply. The pipe was followed as far as a small unit located in the Heat Distribution unit which had three other connecting pipes. This was assumed to be the heat exchanger, and, at this stage the inspection continued to the PU return pipe. This began similarly from the PU and followed the path as far as possible. In similar fashion, the bespoke SHL was followed. The starting point was the H/X, at the supply to the SHL.

Schematic Development

The hand drawn sketches taken from the initial visual inspections were combined electronically. Initially this was attempted on Solidworks, however this proved to be too time consuming as all symbols would have to be drawn from scratch. Solidworks Electrical was chosen instead to develop the CHP schematic. Particularly useful on Solidworks Electrical, is a built in symbols library, and the ability to distinguish between hot and cold pipes using a colour code. "Hotter" pipes were given the colour red, and "colder" pipes the colour blue to represent the supply and return pipes respectively. Additionally, a light green line was used to indicate an electrical cable.

A logical labelling system was created for the components in order to cross reference between the schematic and the actual system. For instance, the first valve encountered on the PU loop supply was given V1. A prefix was given to each type of component in the system, given in the nomenclature, with numbering in ascending order in the same direction as the visual inspection. Labels were added to the components in clear locations for ease of back referencing.

Flow arrows were added to the schematic in locations where the known direction is fairly certain, however some instances of pipe lengths were left with uncertainty, which would require further investigation work.

Schematic Validation

A validation study was required to determine the accuracy of the initial schematic assumptions. Firstly, temperatures were taken at several locations around the system under the existing stable running conditions. Measurements would be taken using thermocouples and the temperature gauges to make comparisons between sections of pipes.

Secondly, flowrates would be taken at various locations around the bespoke SHL to confirm flow directions and to investigate where the pipe flow directions are

unknown. The flowmeter used will be a TTUF as it offers better accuracy and lower uncertainty than other types available such as a DUF or a CCUF and is relatively inexpensive when compared to spool piece flow meters. The TTUF will be located to minimise the effects of turbulence in the flow where possible, with adherence to the manufacturer's recommendations (Endress+Hauser GmbH, 2005). The two ECLs (Electronic Control Units) would be explored to identify: where the temperature measurements are being made, and, to what affect controlling the actuators has on the system. This was achieved by systematically altering one setting at a time and observing changes. The finished schematic is included as Figure 15 in the Results section.

Safety Inspection

In action of the health and safety risk assessment, a safety inspection was carried out prior to experimentation. Firstly, it was discovered that the two 9kW electrical fan heaters used to provide a load for the CHP were not Portable Appliance Tested (PAT) tested. Secondly, a minor gas leak was discovered using a detector which indicated a concentration of gas to air ratio by volume of over 4×10^{-5} . This led to actions to get all the applicable units PAT tested in the laboratory and to fix the gas leak on the PU gas supply.

Results

Controls Documentation

It was confirmed that the PU supply and return pipes were correct as observations found T1 as greater than T3, see Network Diagram in Figure 3. The SHL supply and return pipes were confirmed as the TC at V7, on the supply pipe, was greater than the TC at V10, on the return pipe. See TC locations in Figure 4. This validated the two loops for the relative supply and return pipes.

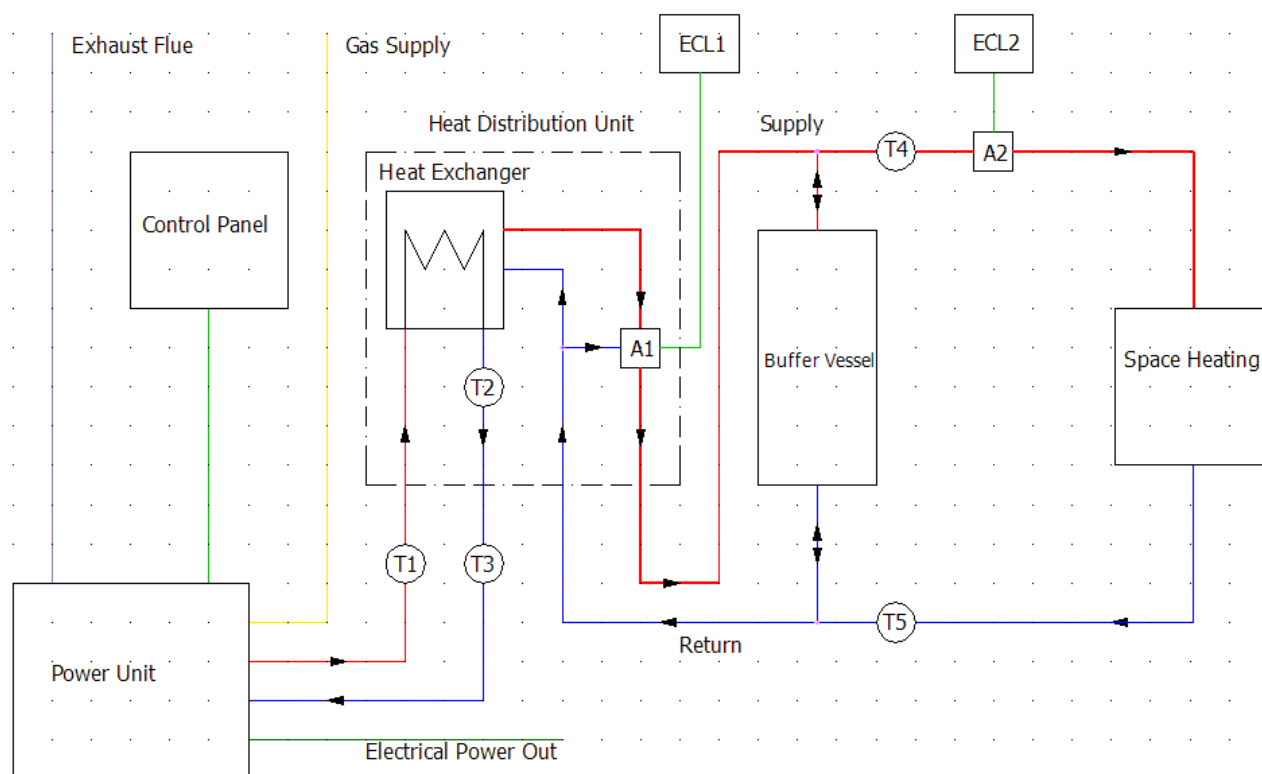

Figure 3: Network Diagram

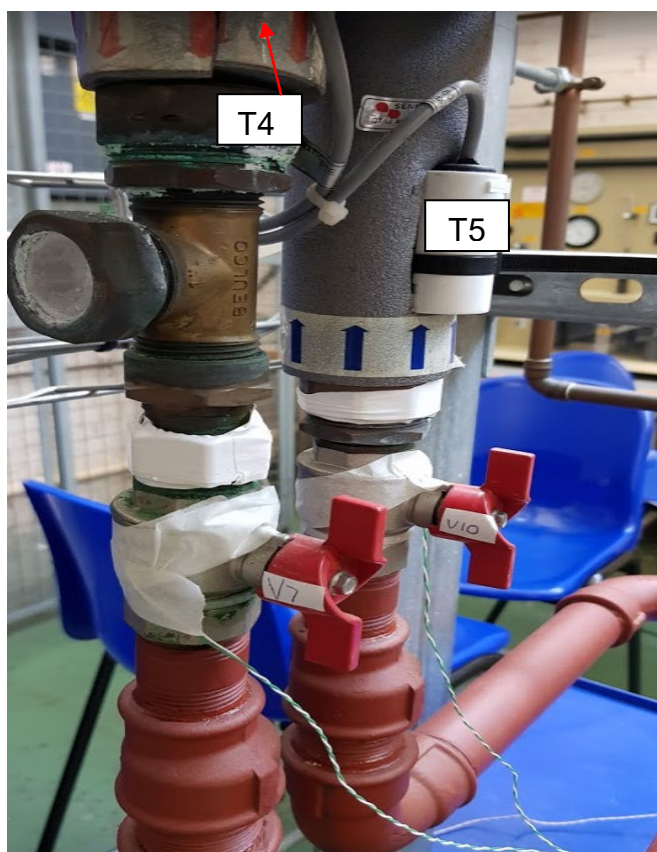

Figure 4: TCs at V7 and V10, and T4 and T5 Locations

It was found that there was a correlation between temperature readings of ECL2 and the TCs at V7 and V10, see Figures 6 and 7. This indicates that ECL2 provides the readings of the surface temperature sensors T4 and T5. TC at V7 was on average 1.5°C higher than T4, and TC at V10 was 0.8°C higher than T5. The systematic error may be due to the calibration of the electronic sensors or possibly due to imperfect contact of the thermocouple fixing to the outer pipe surface.

The ECL1 temperature readings were taken and was observed to display similar temperature readings as the temperature gauge T3, see Figure 5, therefore indicating ECL1 is connected to the surface temperature sensor at T2. T3 was on average 0.3°C less than T2. This could be due to systematic error due to T2 being a surface temperature sensor and T3 being a thermometer gauge. T2 appears to fluctuate rapidly with changing temperature whereas T3, the gauge, is much more stable and is less responsive to the fluctuations.

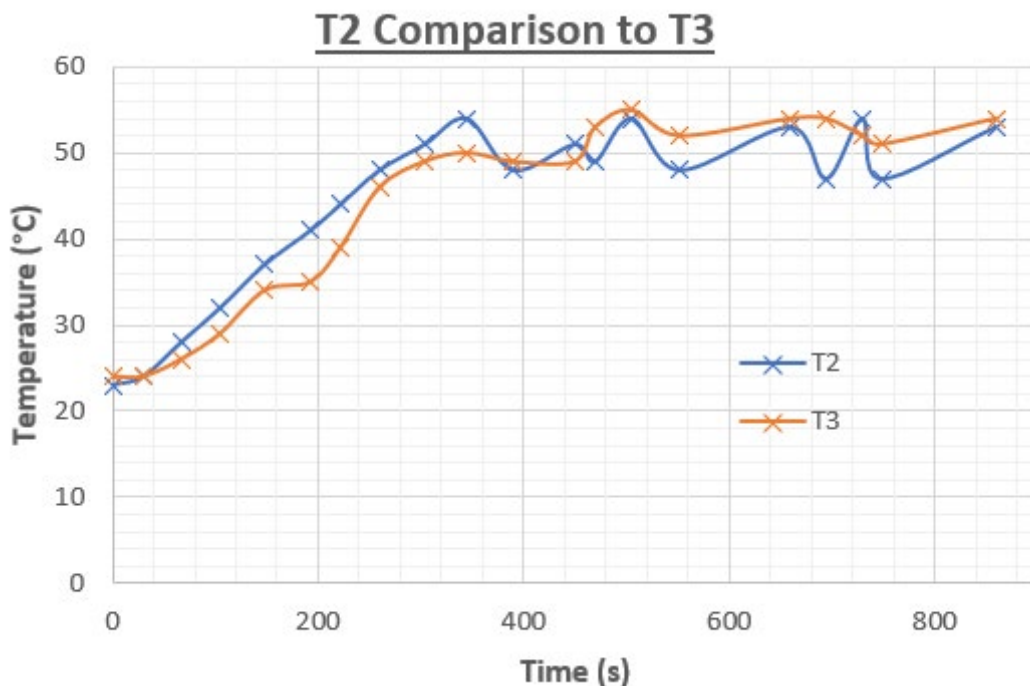

Figure 5: T2 vs.T3

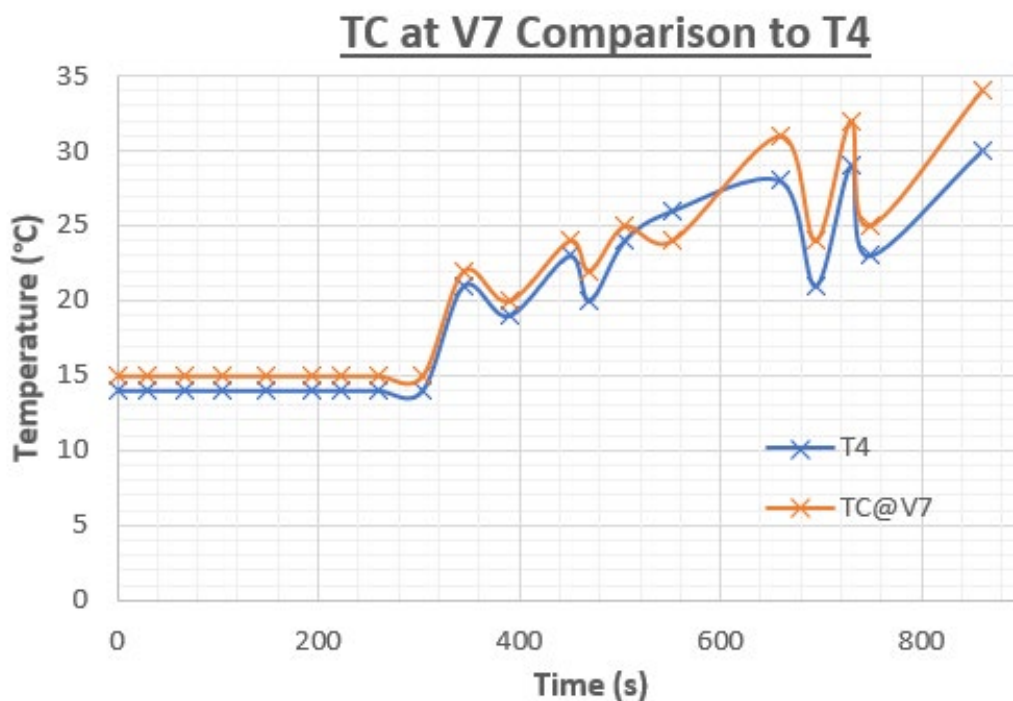

Figure 6: TC@V7 vs. T4

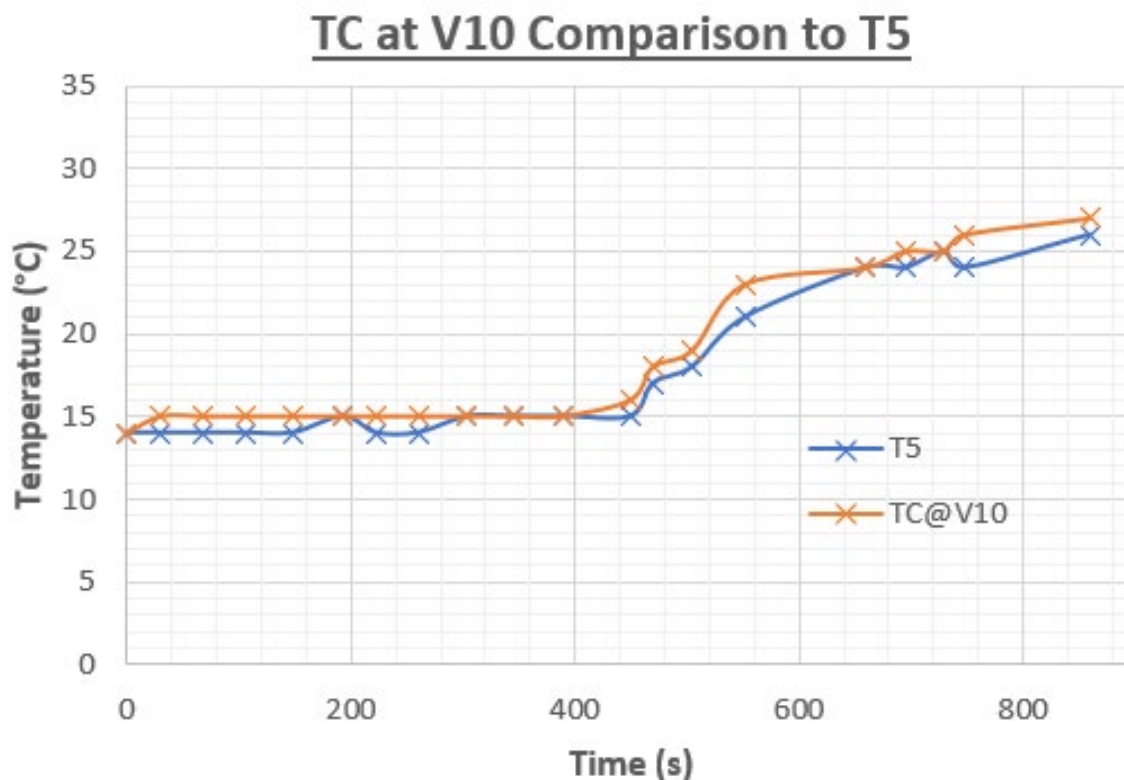

Figure 7: TC@V10 vs.T5

To investigate what ECL1 does in response to its T2 reading, the desired temperature setting was adjusted. This was currently set as 60°C. Temperatures for T2, T4 and T5 were recorded over the course of changing the setting on ECL1 from 60°C to 50°C, see Figure 8.

A1 was observed to fluctuate back and forth which maintained T2 around 60°C. When the ECL1 setting was changed to 50°C, T2 dropped and settled around 50°C, indicating ECL1 controls A1 to achieve the desired temperature at T2. In other words ECL1 regulates the PU return to the desired temperature.

T4 fluctuated as it responded to A1 opening and closing. This showed A1 recirculates the SHL when closed and allowed flow through the heat exchanger when open. T4 was observed to suddenly rise after the ECL1 setting was changed.

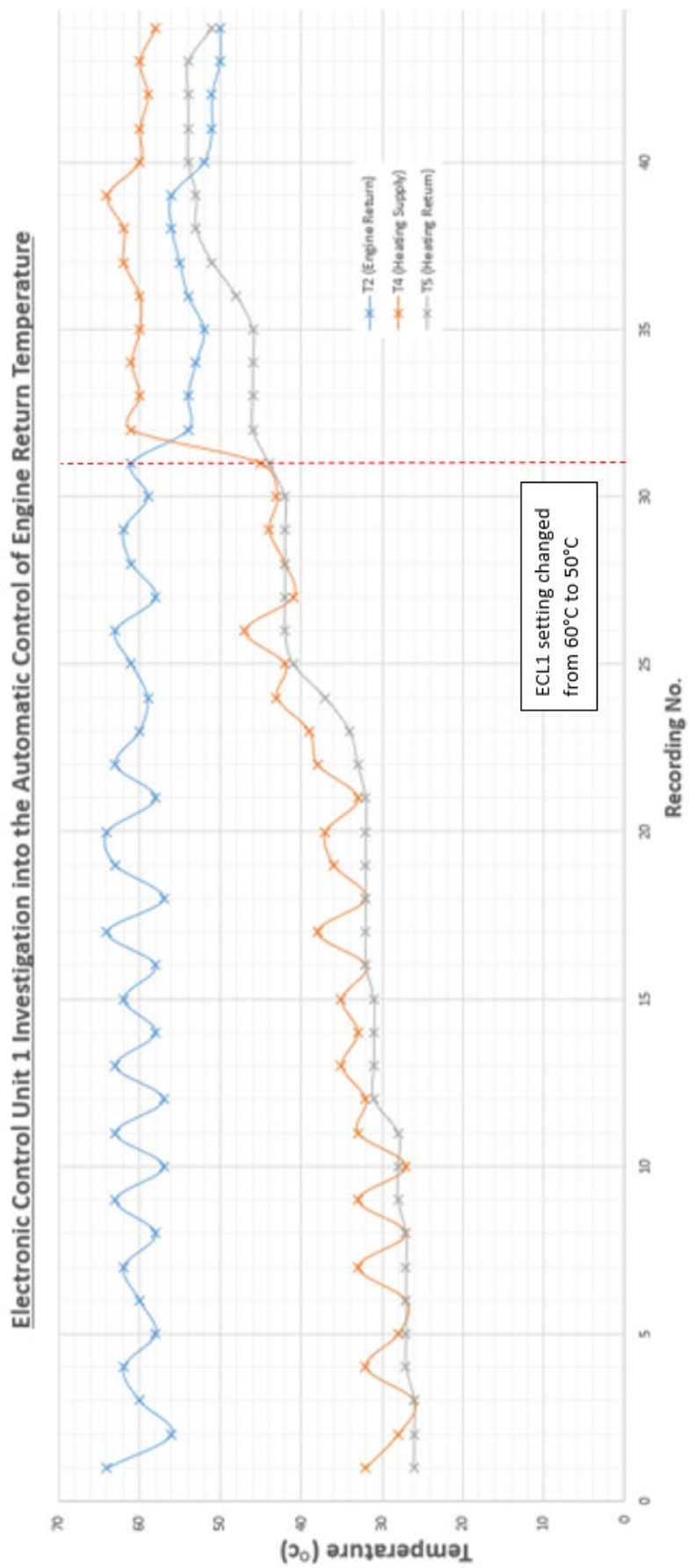

Figure 8: ECL1 Investigation

To investigate this, TCs were attached to the top and bottom of the BV at V5 and V14 respectively, in similar fashion to Figure 4. T2 was set to 50°C using ECL1. The findings from this can be found in Figure 10. A similar pattern was observed again for T2, T4 and T5 as per Figure 8. The TC readings at V14 remained about the same as T5 until 3150 seconds, then it suddenly drops off. The TC at V5 at this point then rises close to the reading of T4. This indicated a sudden change in the temperatures going to and from the BV, however the direction of flow was unknown.

Therefore, a TTUF was then fixed to a suitable pipe section connected to the bottom of the BV, as per Figure 9. The flowrates of this section of pipe were then recorded in Figure 11.

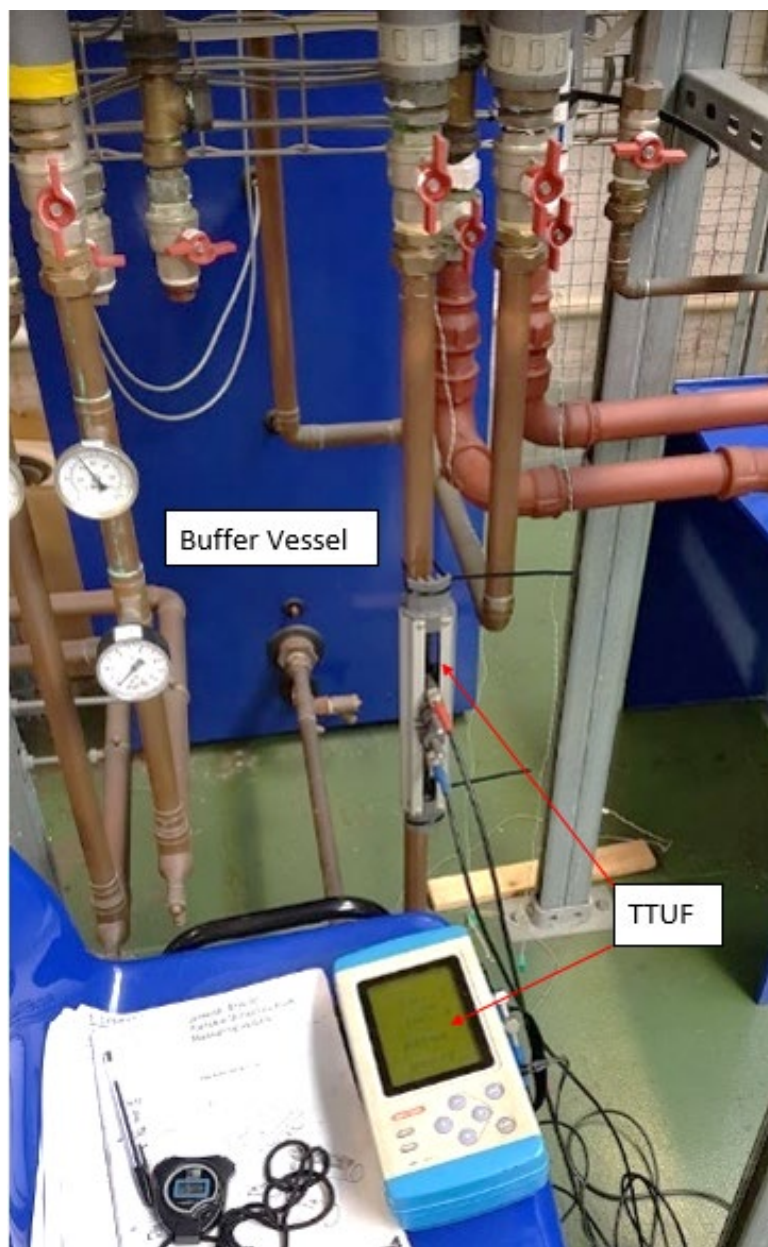

Figure 9: TTUF at BV bottom pipe

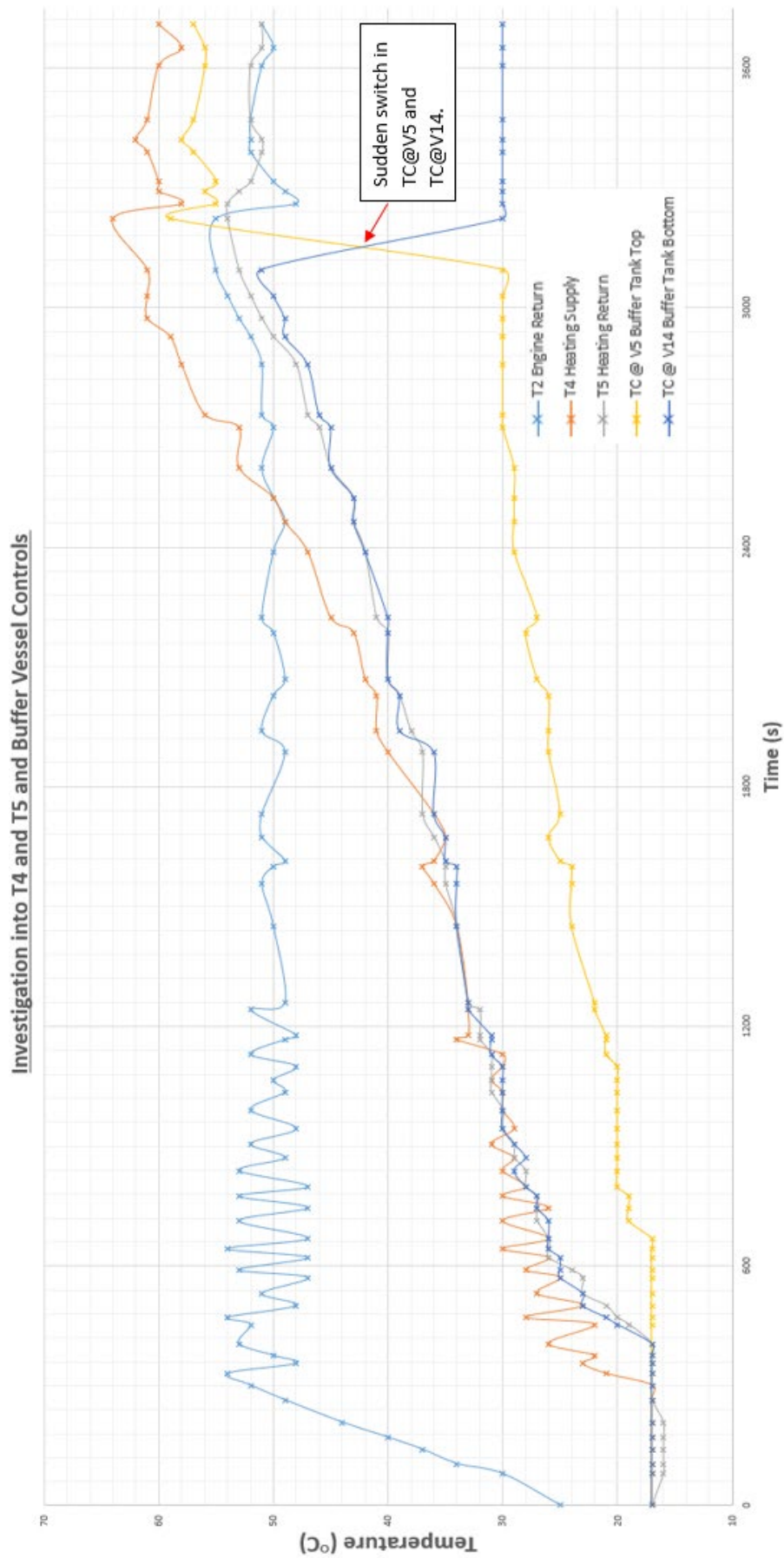

Figure 10: BV Investigation

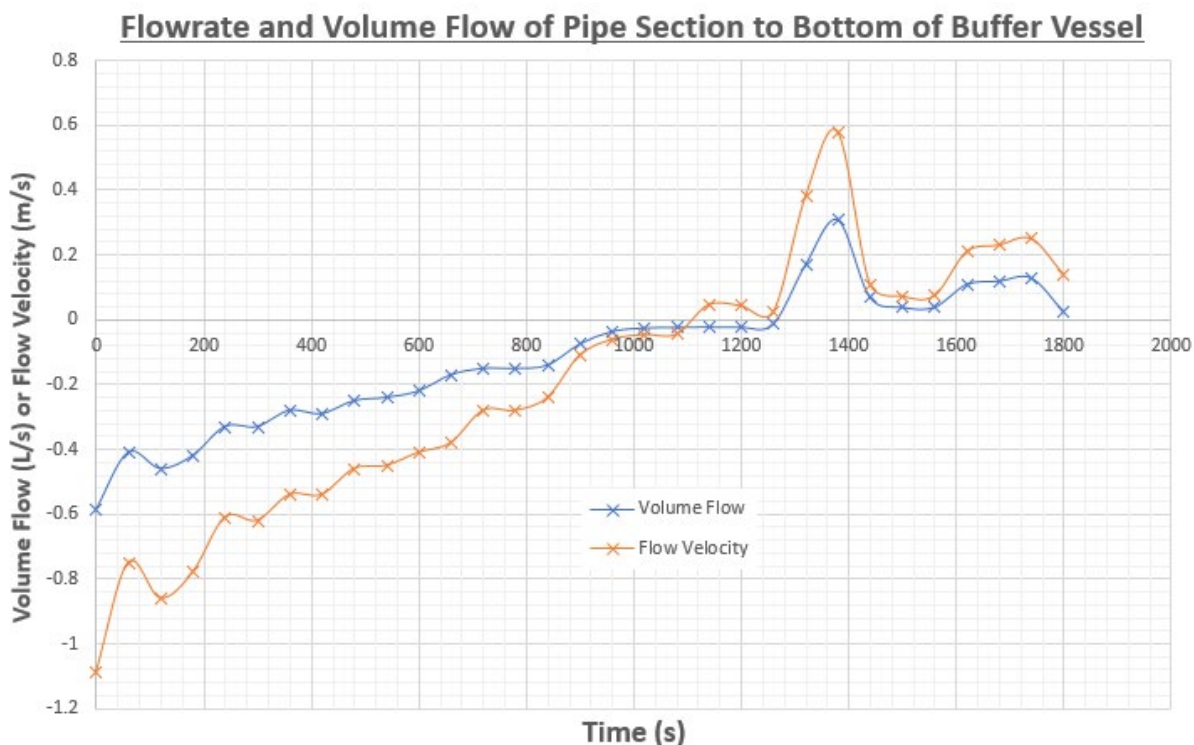

Figure 11: TTUF on Pipe Section to BV

The flowrates read negatively initially in Figure 11, because flow was in the opposite direction to the mounting of the TTUF. For convention, the red wire was connected downstream and the blue wire was connected to the upstream, as per Figure 12.



Figure 12: Connections on the TTUF

Therefore with reference to Figures 9, 11 and 12, it was known that the flow was into the bottom of the BV when the values were negative. After about 1100 seconds on Figure 11 it can be seen the flow velocity becomes positive indicating that the flow

direction had changed. This explains the sudden rise in T4 in Figure 7 and the sudden switch of TC@V5 and TC@V14 in Figure 9.

To validate the readings, the TTUF was fixed to the overhead SHL supply pipe, Figure 13, with sufficient pipe length, as per Figure 10, to minimise flow disturbances.



Figure 13: TTUF Location in SHL

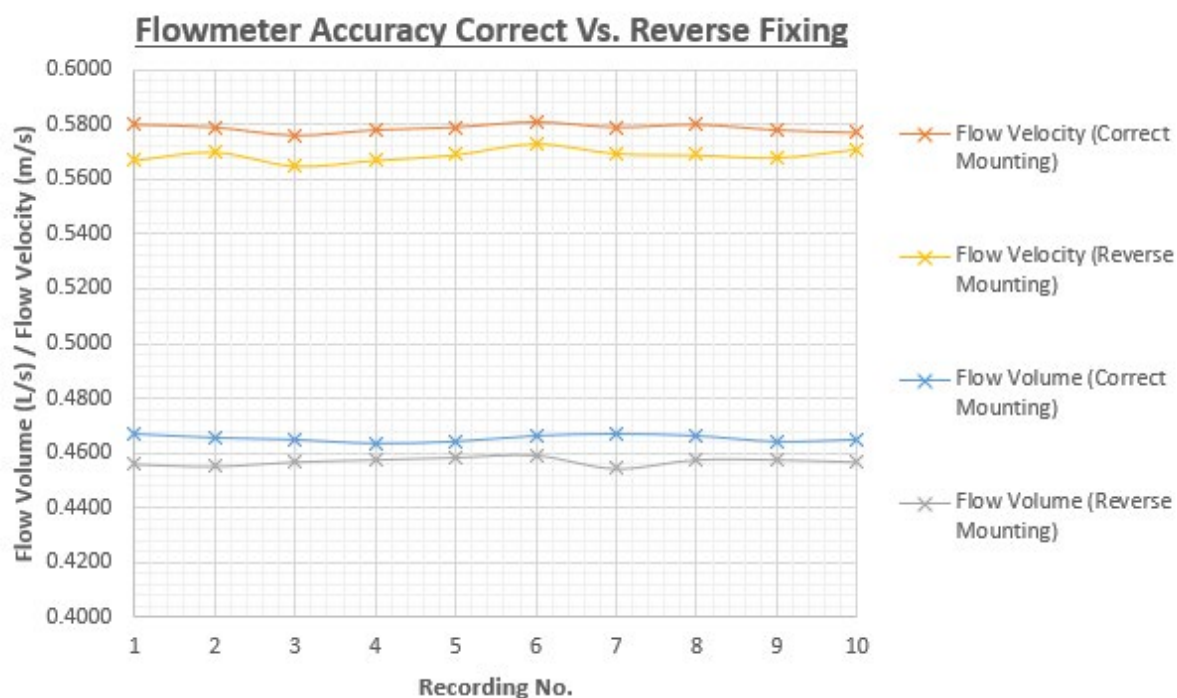

Figure 14: TTUF Systematic Error

Figure 14 shows mounting the flowmeter the reversely produces a systematic error. For flow velocity and flow volume, values were 0.01m/s and 0.008 L/s lower respectively. This would need to be taken into account to correct any negative values. The values of systematic error are not significant enough to counter the conclusion from Figure 11.

The resulting schematic was produced from the outcome of the investigations, in Figure 15. A final study was then undertaken to understand the controlling function of ECL2 and A2. Data was taken of temperatures around the system, see Figure 16, which now could be fully explained by the controls of the system.

In Figure 16, T2 is set to 50°C on ECL1, the same as Figure 10. Around 2800 seconds T4 exceeds 60°C, which is the desired Domestic Hot Water (DHW) temperature set on ECL2. ECL2 partially closes A2 causing the excess heat flow to enter the top of the BV.

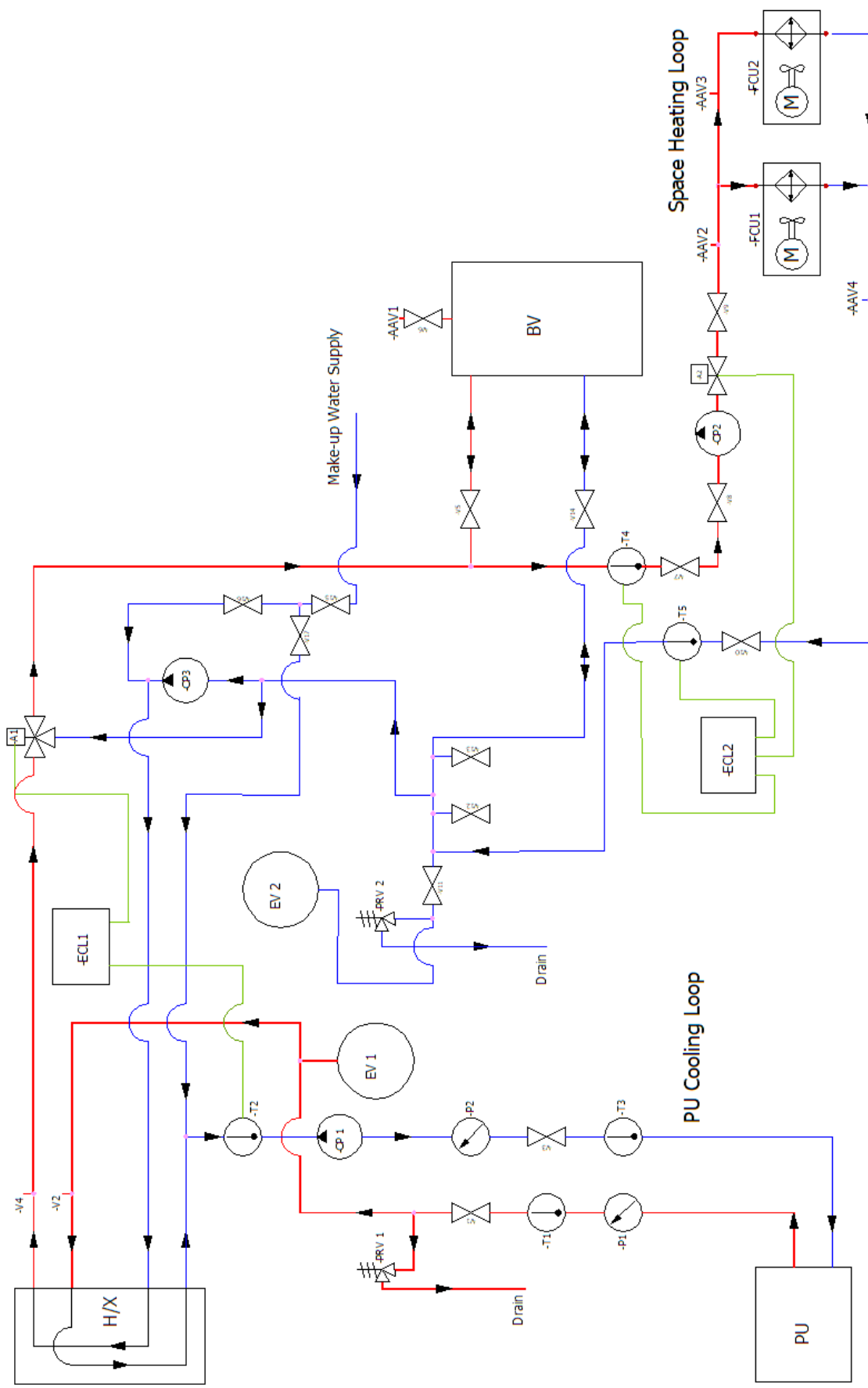

Figure 15: CHP Schematic

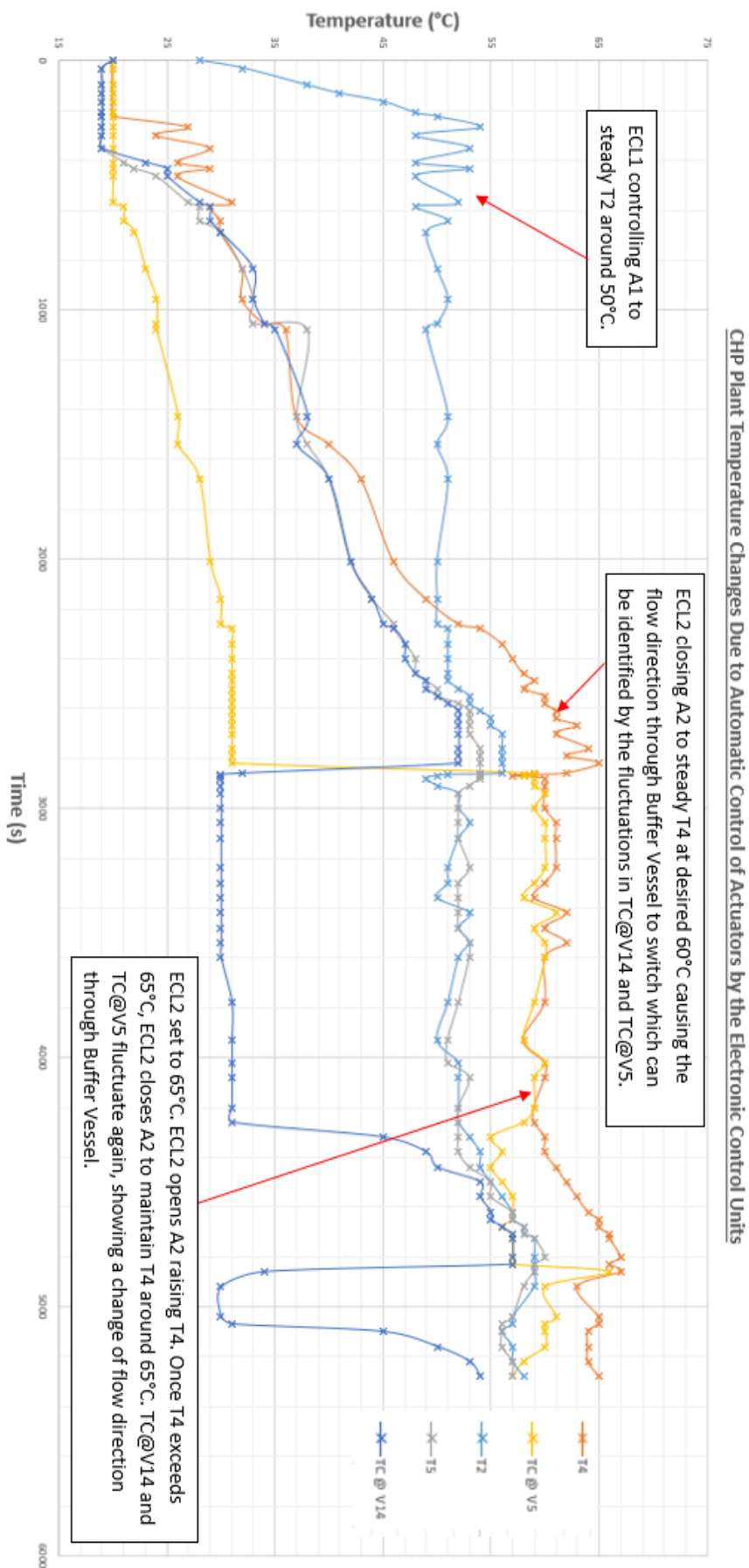

Figure 16: ECL2 Investigation

At about 4000 seconds ECL2 was changed to 65 °C, in order to validate how ECL2 operates A2. It appears that ECL2 opens A2 which reversed the flow through the BV. Once T4 exceeded 65°C, A2 closed partially causing the flow through the BV to switch. T4 then settled around 65°C as set on ECL2.

T2 was raised to around 55°C, despite ECL1 keeping A1 wide open as it was set at 50°C. This was because T4 was at 65°C, which made T5 higher than 50°C. This indicates that when $T5 > ECL1$ setting, T2 is dictated by T5. This suggests for ECL1 to regulate T2 at the set temperature, ECL2 setting must be no more than about 10°C greater than ECL1.

Efficiency Measurements

The efficiency measurement method of the CHP plant could now be assessed. Three assumptions of “useful heating” will be explored. Testing was at full W_{elec} and at part W_{elec} . These conditions were chosen to align with the EU Directive, see Figure 5.

For each condition, the volumetric gas consumption and running time was recorded. W_{elec} and W_{heat} (PU), as displayed on the main control unit, were noted down. T1, T2 were recorded to produce the average PU temperature, and T4 and T5 to gather a temperature difference across the SHL.

Temperatures were taken at the far end of the SHL near the FCUs using thermocouples as per Figure 17. These temperatures of the supply and return pipes were labelled TS and TR respectively. A computer logger was used to record the TC values, along with T4 and T5 values taken from the ECL2 display, as displayed in Figure 18.



Figure 17: TS and TR Locations

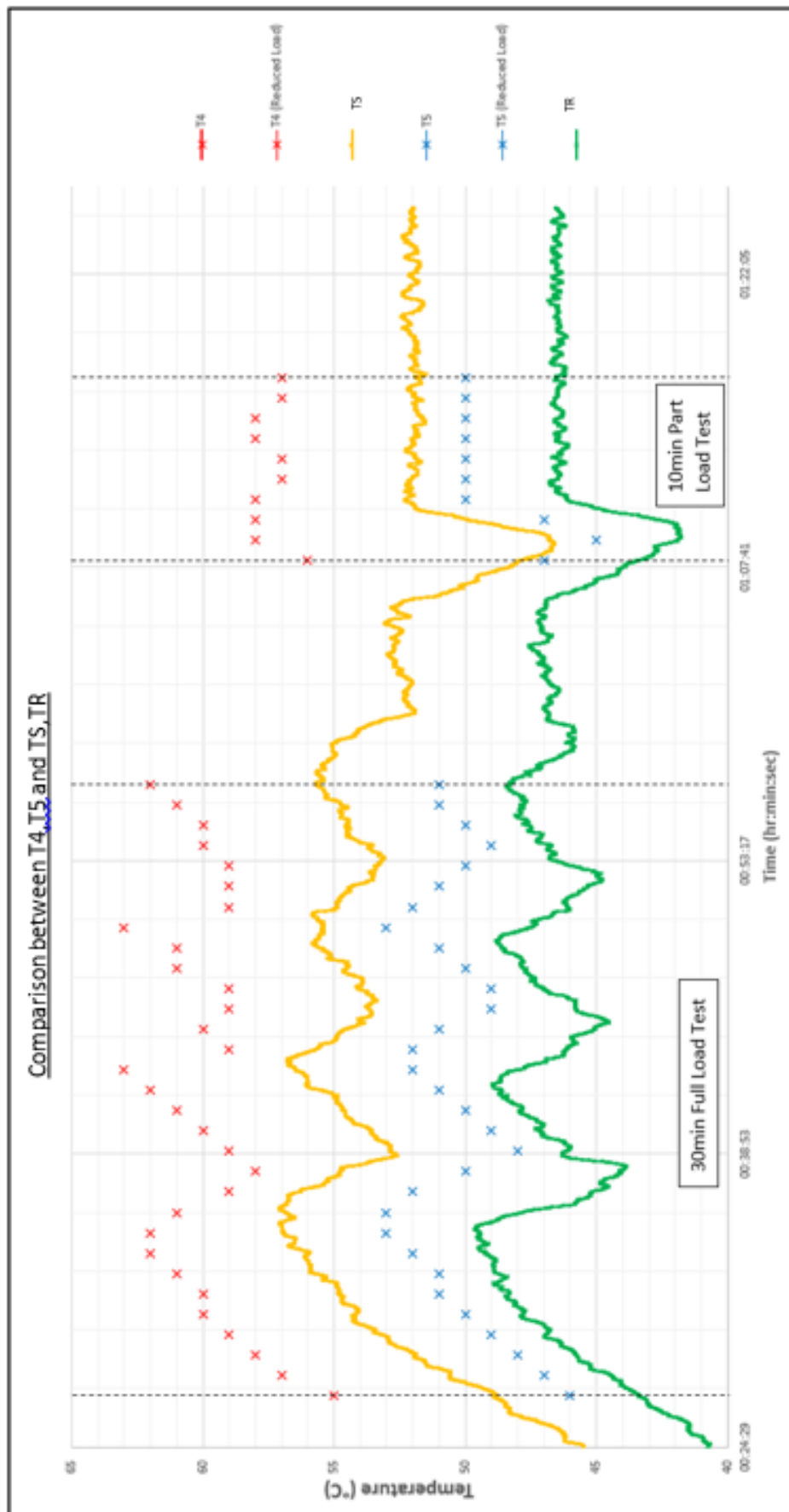

Figure 18: T4, T5 vs. TS, TR

From Figure 18, TS was on average 5.9°C less than T4 showing heat transfer to the surrounding space during distribution, whether or not this heat transfer is “useful”, will be discussed. TR was on average 3°C less than T5. This implies a heating increase from TR to T5 in the Heat Distributer. 3°C is above the systematic error that can be associated with TCs which is about ±1°C, so either there must be some heat gain, perhaps from the SHL supply pipe which is routed close to the return pipe, or it is due to imperfect contact between the TC and the pipe surface. Lack of insulation to the TCs may also be a contributing factor.

Thermal efficiency may be defined as:

$$\eta_{th} = \frac{W_{out}}{q_{in}} \quad (1), \text{ (Horlock, 1987)}$$

Where: η_{th} = Overall Thermal Efficiency (%), q_{in} = Rate of Gas Energy Consumption (kW), W_{out} = Useful Output Energy (kW)

For CHP plants, the useful output energy is a combination of the electrical energy generated, and the useful space heating energy:

$$\eta_{th} = \frac{W_{Elec} + W_{Heat}}{q_{in}} \quad (2), \text{ (Horlock, 1987)}$$

Where: W_{Elec} = Electrical Power Output (kW), W_{Heat} = Useful Space Heating Power (kW)

W_{elec} was recorded directly from the main control panel, and adjusted via two 9kW electrical fan heaters.

The q_{in} results is summarised in Figure 19, using:

$$q_{in} = Q \times C_v \times \rho_{gas} \quad (3), \text{ (Horlock, 1987)}$$

Where: Q = Rate of Gas Consumption (m³/s), C_v = Calorific Value of Natural Gas (MJ/kg) (Engineeringtoolbox.com, 2019), ρ_{gas} = Natural Gas Density (kg/m³) (Engineeringtoolbox.com, 2019).

Systematic error which may be present from the minor gas leak identified during the safety inspection was assumed to be negligible in the final efficiency results.

<i>Full Load Measurements</i>			Gas Used in 30 mins	
Gas before	1457.2 m ³		2.118 m ³	
Gas after	1459.3 m ³		0.001177 m ³ /s	
			47.2 q _{in} /kW	
<i>Half Load Measurements</i>			Gas Used in 30 mins	
Gas before	1459.6 m ³		1.285 m ³	
Gas after	1460.9 m ³		0.000714 m ³ /s	
			28.6 q _{in} /kW	

Figure 19: Rate of Gas Energy Consumption

Three assumptions of “useful heating” were calculated:

- $W_{heat} (PU)$, all heating power produced by the PU is useful.
- $W_{heat} (\Delta T_{4,5})$, the excess heating power to the BV is not useful.
- $W_{heat} (\Delta T_{S,R})$, heat transfer during distribution is not useful space heating.

$W_{heat} (\Delta T_{4,5})$ and $W_{heat} (\Delta T_{S,R})$ can be calculated as:

$$W_{Heat} = C_p \times \Delta T \times \rho_{water} \times Q \quad (4), \text{ (Horlock, 1987)}$$

Where: Q=Volumetric Flow (m³/s), Cp=Specific Heat Capacity of Water (kJ/(kgK)), ρ_{water} =Water Density (kg/m³), ΔT =Temperature Difference (°C)

Full results are recorded in Appendix 1, with a summary in Figure 20.

W_{Elec} (kW)	η_{elec} %	Vol. Flow (L/s)	$\Delta T_{1,2}$ (°C)	$\Delta T_{4,5}$ (°C)	$\Delta T_{S,R}$ (°C)	$W_{heat} PU$ (kW)	$W_{heat} (\Delta T_{4,5})$ (kW)	$W_{heat} (\Delta T_{S,R})$ (kW)	$W_{heat} Efficiency$ %	$W_{heat} Efficiency$ %	$W_{heat} Efficiency$ %	η_{th} % (PU)	η_{th} % ($\Delta T_{4,5}$)	η_{th} % ($\Delta T_{S,R}$)
13.3	28.1	0.459	62.0	9.6	7.5	30.3	18.5	13.7	64.2	39.2	29.1	92.3	67.3	57.2
5.7	19.8	0.537	56.3	8.5	5.5	19.9	18.8	12.2	69.6	65.5	42.6	89.5	85.3	62.4

Figure 20 Summary of Efficiency Measurement

$W_{heat} (PU)$ produced a $\eta_{th} (PU)$ of 92.3% for W_{elec} at 13.3kW and 89.5% for W_{elec} at 5.6kW. This agrees with Figure 6. $\eta_{th} (PU)$ is likely EC Power’s chosen method for convenience and due to uncertainties in the end users bespoke SHL systems.

Using $W_{heat} (\Delta T_{4, 5})$ produced a $\eta_{th} (\Delta T_{4, 5})$ of 67.3% and 85.3% for W_{elec} at 13.3kW and 5.7kW respectively.

The difference between η_{th} (PU) and η_{th} ($\Delta T4, 5$) at W_{elec} 5.7kW is only 4.1%. This might be because all W_{heat} produced is being sent across the SHL.

At W_{elec} 13.3kW, there is a significant 25.9% difference between η_{th} (PU) and η_{th} ($\Delta T4, 5$), see Figure 20. In Appendix A, it can be seen in the full data multiple points where values of T4 are greater than 60°C and Q is reduced, indicating that excess W_{heat} is diverted to the BV by ECL2. So at points in the testing, using W_{heat} ($\Delta T4, 5$) is only measuring a part of the total W_{heat} produced by the PU, and hence an observed reduction in η_{th} . There was a large variation in η_{th} ($\Delta T4, 5$), as displayed by the range bars in Figure 21, which is due to the BV.

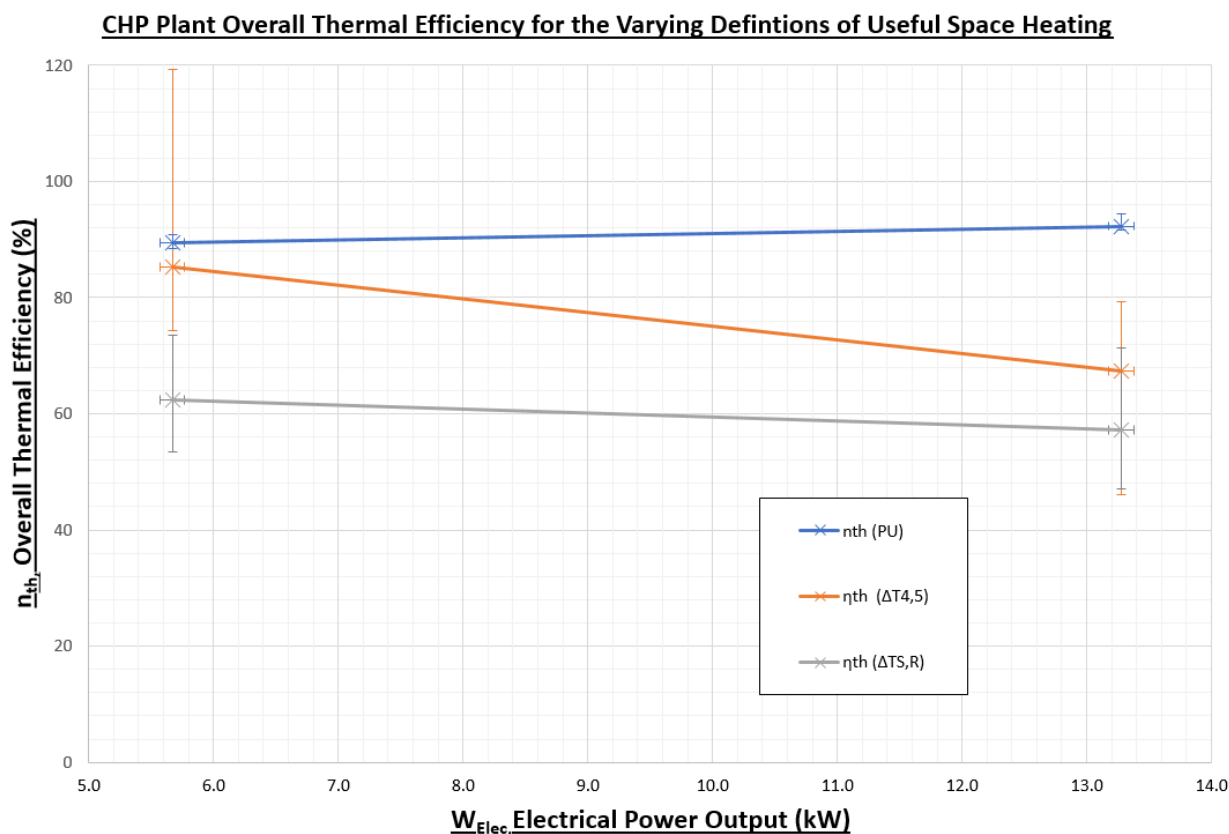

Figure 21 – η_{th} of CHP Plant

W_{heat} ($\Delta TS,R$) produced an even lower η_{th} ($\Delta T4,5$), for both W_{elec} at 13.3kW and 5.7kW at 57.2% and 62.4% respectively. This is due to heat transfer to space during the distribution which is assumed not useful.

Conclusions

Visual inspection proved to be effective as it enabled quick sketches to be made. Producing the schematic on Solidworks Electrical required new learnings, including: comprehending the software interface and familiarity with the available schematic tools. The symbol library package adhered to ISO 1219-1:2012: Graphical symbols and circuit diagrams, (International Organization for Standardization, 2012). The PU, H/X, BV, and EVs were displayed as geometric shapes, it was decided to deviate from the IEC standard for clarity.

The following assumptions can be made when assessing η_{th} :

- If all the heating power produced by the PU is regarded as heat transfer to useful space then η_{th} can be as high as >90%.
- If the W_{heat} stored by the BV is considered not useful, η_{th} can vary depending on W_{elec} . If the PU is generating more heat than is required by the space heating, then surplus is sent to the BV which reduces η_{th} .
- If heat transfer is not to a useful space during distribution in the SHL, η_{th} can be more toward $\approx 60\%$ depending on the employed insulation and the length of distribution in unrequired space.

The chosen method of assessing η_{th} depends on the necessity of the measurement.

To closer meet the EU Directive requirements the PU could be considered to act as a boiler with an average boiler temperature ($\Delta T_1, T_2$). η_{th} (PU) was measured at rated power (P_n) and at $0.6P_n$. Where P_n could be considered to be the maximum W_{heat} (PU) of 30.3kW which occurs at a maximum W_{elec} of 13kW. Partial P_n could therefore be adjusted by controlling W_{elec} .

η_{th} (PU) at 62°C ($\Delta T_1, T_2$) at P_n :

$$92.3 \geq 87 + 2\log(30.3)$$

η_{th} (PU) at 56°C ($\Delta T_1, T_2$) at $0.6P_n$:

$$89.5 \geq 86 + 2\log(19.9)$$

This suggests an energy performance label of “★★”, per Figure 4. However this method deviates from the EU Directive in that η_{th} (PU) at P_n was not taken at exactly 70°C ($\Delta T_1, T_2$), and the $0.6P_n$ test was not taken at the required $0.3P_n$. The deviations were due to difficulties in setting W_{elec} low enough to meet $0.3P_n$, as the CHP plant has a minimum W_{heat} of 4kW.

For the η_{th} measurement methodology to closer comply with ISO17025:

- TTUF systematic error can be found using different mounting positions. This was found to be approximately 0.008L/s.
- TC analogue box and computer logger can be mutually calibrated by switching points of measurement and comparing results.
- The ECL surface temperature sensors could be calibrated against TC readings in the same locations. This was found to be $\approx 0.3^\circ\text{C}$.

The CHP plant could successfully be reverse engineered through experimentation to create a full system schematic. An assessment of the overall efficiency measurement method was made, including discussion on the judgement that is required when determining what is “useful space heating” in CHP systems.

A protocol was discussed on how it may be possible to bring the CHP plant into closer compliance with the EU Boiler Efficiency Directive. Areas of priority to closer comply with ISO17025 were identified, with certain calibrations and the tracing of some systematic errors helping to closer meet the terms of the standard. Although it is recognised that entire compliance to both is currently unfeasible. In future, there may be opportunities to overcome any issues.

Overall the research objectives were successfully met, with good progress made towards meeting the research aims criteria.

Recommendations

Further work into the ECL settings could be attempted. For research scope, the vast majority of the ECL settings were unchanged. It may be possible to tune these parameters to enhance the bespoke SHL by making better use of the Buffer Vessel making the CHP system run at higher efficiencies for greater periods of time.

Acknowledgements

I would like to give thanks to Dan Hatton for his help and guidance throughout the research, to Rick Preston for allowing me use of the Brunel Laboratory, and to the Marine Building Technicians for allowing me use of the Ultrasonic Flow equipment.

References

- Abusoglu, A. and Kanoglu, M. (2008). First and second law analysis of diesel engine powered cogeneration systems. *Energy Conversion and Management*, 49(8), pp.2026-2031.
- Bentley, R. (1998). *Handbook of Temperature Measurement Vol. 3: Theory and Practice of Thermoelectricity and Thermometry*. Singapore: Springer.
- Blaxter, L., Hughes, C. and Tight, M. (2013). *How to research*. Berkshire: McGraw-Hill - Open University Press.
- Blunt, A. and Pychyl, T. (2000). Task aversiveness and procrastination: a multi-dimensional approach to task aversiveness across stages of personal researchs. *Personality and Individual Differences*, 28(1), pp.153-167.
- BSI Standards Publication (2015). *BS EN ISO 9001:2015 Quality management systems Requirements*. London, England: BSI.
- BSI Standards Publication (2017). *BS EN ISO/IEC 17025:2017 General requirements for the competence of testing and calibration laboratories*. London, England: BSI.
- Carlander, C. and Delsing, J. (2000). Installation effects on an ultrasonic flow meter with implications for self-diagnostics. *Flow Measurement and Instrumentation*, 11(2), pp.109-122.
- Childs, P. (2001). *Practical temperature measurement*. Oxford: Butterworth-Heinemann.
- Council of the European Union (1992). *COUNCIL DIRECTIVE 92/42/EEC of 21 May 1992 on efficiency requirements for new hot-water boilers fired with liquid or gaseous fuels*. Official Journal of the European Communities.
- Dentice d'Accadia, M., Sasso, M., Sibilio, S. and Vanoli, L. (2003). Micro-combined heat and power in residential and light commercial applications. *Applied Thermal Engineering*, 23(10), pp.1247-1259.
- Department for Business, Energy & Industrial Strategy (2018). *Aggregated energy balances showing proportion of renewables in supply and demand Special feature – Energy balances proportion of renewables*. [ebook] 27 September 2018. Available

at:

[https://assets.publishing.service.gov.uk/government/uploads/system/uploads/attachment_data/file/743652/Aggregated Energy Balances showing proportion of renewables.pdf](https://assets.publishing.service.gov.uk/government/uploads/system/uploads/attachment_data/file/743652/Aggregated_Energy_Balances_showing_proportion_of_renewables.pdf) [Accessed 29 Nov. 2018].

Department of Energy & Climate Change. (2011). UK Renewable Energy Roadmap. [online] Available at:

https://assets.publishing.service.gov.uk/government/uploads/system/uploads/attachment_data/file/48128/2167-uk-renewable-energy-roadmap.pdf [Accessed 20 Nov. 2018].

Doran, G. (1981). There's a S.M.A.R.T. way to write management's goals and objectives. *Management Review*, 70(11), pp.35-36.

EC Power (2007). Installation Guide: XGRI13G Combined Heat and Power System. EC Power UK Ltd.

EC Power (2007). Service Manual: XRGI13G NGAS Energy Solution. EC Power UK Ltd.

EC Power (2007). User Manual: XRGI13G NGAS Energy Solution. EC Power UK Ltd.

Ec.europa.eu. (2019). EUROPA - European Commission - Growth - Regulatory policy - NANDO. [online] Available at: http://ec.europa.eu/growth/tools-databases/nando/index.cfm?fuseaction=directive.notifiedbody&dir_id=11 [Accessed 4 May 2019].

Ecpower.eu. (2018). Home - EC POWER - EN. [online] Available at: <https://www.ecpower.eu/en/> [Accessed 22 Oct. 2018].

Endress + Hauser GmbH (2005). Portable Ultrasonic Flow Measuring System Prosonic Flow 92 Temporary volume flow measurement of liquids with "Clamp On" sensors Technical Information TI 060D/06/en 50102085. [ebook] Weil am Rhien Germany: Endress + Houser. Available at: <http://www.merteh.lv/eh/pdf/TI060DEN.PDF> [Accessed 17 Apr. 2019].

Engineeringtoolbox.com. (2019). Fuels - Higher and Lower Calorific Values. [online] Available at: https://www.engineeringtoolbox.com/fuels-higher-calorific-values-d_169.html [Accessed 8 May 2019].

European Union. (2018). Regulations, Directives and other acts - European Union - European Commission. [online] Available at: https://europa.eu/european-union/eu-law/legal-acts_en [Accessed 27 Nov. 2018].

Fretten, C. and Miller, V. (2016). *The European Union: a guide to terminology, procedures and sources*. Number 03689: House of Commons Library.

GASTEC at CRE Ltd (2009). Final Report: In-situ monitoring of efficiencies of condensing boilers and use of secondary heating. [online] Cheltenham, England: Energy Saving Trust. Available at: [https://assets.publishing.service.gov.uk/government/uploads/system/uploads/attachment_data/file/180950/In-situ monitoring of condensing boilers final report.pdf](https://assets.publishing.service.gov.uk/government/uploads/system/uploads/attachment_data/file/180950/In-situ_monitoring_of_condensing_boilers_final_report.pdf) [Accessed 3 Dec. 2018].

- Gvozdenac, D., Urošević, B., Menke, C., Urošević, D. and Bangviwat, A. (2017). High efficiency cogeneration: CHP and non-CHP energy. *Energy*, 135, pp.269-278.
- Hans, E., Herroelen, W., Leus, R. and Wullink, G. (2007). A hierarchical approach to multi-research planning under uncertainty. *Omega*, 35(5), pp.563-577.
- Horlock, J. (1987). *Cogeneration: Combined Heat and Power Thermodynamics and Economics*. Oxford: Pergamon Press.
- Hse.gov.uk. (2018). Design Codes - Pipework. [online] Available at: <http://www.hse.gov.uk/comah/sragtech/techmeaspipework.htm> [Accessed 23 Oct. 2018].
- Hunt, T. and Vaughan, N. (1996). *The hydraulic handbook*. Oxford: Elsevier Advanced Technology.
- International Organization for Standardization (2012). ISO 1219-1:2012 Fluid power systems and components -- Graphical symbols and circuit diagrams -- Part 1: Graphical symbols for conventional use and data-processing applications. [online] ISO. Available at: <https://www.iso.org/standard/60184.html> [Accessed 7 May 2019].
- Keltner, N. and Beck, J. (1983). Surface Temperature Measurement Errors. *Journal of Heat Transfer*, 105(2), p.312.
- Lee, T. (2010). Second-Law Analysis to Improve the Energy Efficiency of Screw Liquid Chillers. *Entropy*, 12(3), pp.375-389.
- Lund, H., Werner, S., Wiltshire, R., Svendsen, S., Thorsen, J., Hvelplund, F. and Mathiesen, B. (2014). 4th Generation District Heating (4GDH): Integrating smart thermal grids into future sustainable energy systems. *Energy*, 68, pp.1-11.
- Mahadeva, D., Baker, R. and Woodhouse, J. (2009). Further Studies of the Accuracy of Clamp-on Transit-Time Ultrasonic Flowmeters for Liquids. *IEEE Transactions on Instrumentation and Measurement*, 58(5), pp.1602-1609.
- Mahmoudi, A., Fazli, M. and Morad, M. (2018). A recent review of waste heat recovery by Organic Rankine Cycle. *Applied Thermal Engineering*, 143, pp.660-675.
- Michalski, D., Strąk, K. and Piasecka, M. (2017). Comparison of two surface temperature measurement using thermocouples and infrared camera. *EPJ Web of Conferences*, 143, p.02075.
- Nguyen, T., Slawnwhite, J. and Boulama, K. (2010). Power generation from residual industrial heat. *Energy Conversion and Management*, 51(11), pp.2220-2229.
- Nguyen, V., Doherty, P. and Riffat, S. (2001). Development of a prototype low-temperature Rankine cycle electricity generation system. *Applied Thermal Engineering*, 21(2), pp.169-181.
- Pollock, D. (1971). *The Theory and properties of thermocouple elements*. Philadelphia, Pa: American Society for Testing and Materials.
- Sadikoglu, E. and Temur, T. (2012). *The Relationship between ISO 17025 Quality Management System Accreditation and Laboratory Performance, Quality Management and Practices*, Dr. Kim-Soon Ng (Ed.), ISBN: 978-953-51-0550-3. Rijeka: InTech Europe.

Sanderson, M. and Yeung, H. (2002). Guidelines for the use of ultrasonic non-invasive metering techniques. *Flow Measurement and Instrumentation*, 13(4), pp.125-142.

SATO, K., OHIWA, N., ISHIKAWA, A., SHIMOJIMA, H., NISHIYAMA, A. and MORIYA, Y. (2008). Development of Small-Scale CHP Plant with a Wood Powder-Fuelled Stirling Engine. *Journal of Power and Energy Systems*, 2(5), pp.1221-1231.

SAV Systems. (2019). LoadTracker Combined Heat and Power (CHP) | SAV Systems. [online] Available at: <https://www.sav-systems.com/product-groups/combined-heat-and-power/> [Accessed 24 Apr. 2019].

Smith, M., Few, P. and Twidell, J. (1995). Technical and operational performance of a small-scale combined heat-and-power (CHP) plant. *Energy*, 20(12), pp.1205-1214.

Taie, Z., West, B., Szybist, J., Edwards, D., Thomas, J., Huff, S., Vishwanathan, G. and Hagen, C. (2018). Detailed thermodynamic investigation of an ICE-driven, natural gas-fuelled, 1 kW micro-CHP generator. *Energy Conversion and Management*, 166, pp.663-673.

Thomas, B. (2008). Benchmark testing of Micro-CHP units. *Applied Thermal Engineering*, 28(16), pp.2049-2054.

WEBER, K. (2010). Transforming Large Socio-technical Systems towards Sustainability: On the Role of Users and Future Visions for the Uptake of City Logistics and Combined Heat and Power Generation. *Innovation: The European Journal of Social Science Research*, 16(2), pp.155-175.

Wildi, T. (2000). *Electrical machines, drives, and power systems*. Upper Saddle River, N.J.: Prentice Hall.

Wilson, J. (2005). *Sensor technology handbook*. Amsterdam: Elsevier.

Appendices are available as ‘supplementary files’ (please see download area)