

2019-08-19

Wave diffraction from multiple truncated cylinders of arbitrary cross sections

Zheng, Siming

<http://hdl.handle.net/10026.1/14892>

10.1016/j.apm.2019.08.006

Applied Mathematical Modelling

Elsevier BV

All content in PEARL is protected by copyright law. Author manuscripts are made available in accordance with publisher policies. Please cite only the published version using the details provided on the item record or document. In the absence of an open licence (e.g. Creative Commons), permissions for further reuse of content should be sought from the publisher or author.

Title:

Wave diffraction from multiple truncated cylinders of arbitrary cross sections

Author names and affiliations:

Siming Zheng^{a,b}, Yongliang Zhang^b, Jiabin Liu^c, Gregorio Iglesias^{d,a}

a School of Engineering, University of Plymouth, Drake Circus, Plymouth PL4 8AA, UK

b State Key Laboratory of Hydrosience and Engineering, Tsinghua University, Beijing 100084, China

c Key Lab of Structures Dynamic Behavior and Control of the Ministry of Education, Harbin Institute of Technology, Harbin, 150090, China

d MaREI, Environmental Research Institute & School of Engineering, University College Cork, Ireland

E-mail address:

Siming Zheng^{a,b} siming.zheng@plymouth.ac.uk/zhengsm@tsinghua.edu.cn

Yongliang Zhang^b yongliangzhang@tsinghua.edu.cn

Jiabin Liu^c jliu448@aucklanduni.ac.nz

Gregorio Iglesias^{d,a} gregorio.iglesias@ucc.ie

Corresponding author: Gregorio Iglesias

E-mail address: gregorio.iglesias@ucc.ie

Received 28 January 2019, Revised 30 July 2019, Accepted 12 August 2019, Available online 19 August 2019.

DOI: 10.1016/j.apm.2019.08.006

Wave diffraction from multiple truncated cylinders of arbitrary cross sections

Abstract: Many marine structures are supported by piles or caissons which, from a mathematical point of view, can be assimilated to an array of truncated cylinders of arbitrary cross sections. The focus of this paper is such an array subjected to harmonic waves of small steepness. We develop an analytic method based on linear potential flow theory to solve the diffraction problem and evaluate the excitation forces and moments acting on each cylinder. The water domain is divided into the interior regions below each cylinder and an exterior region extending to infinity in the horizontal plane. A series of eigen-functions are applied to express the velocity potential in each region. The Fourier series method combined with the eigen-function expansion matching method is used to satisfy the wetted surface body conditions and continuity conditions between adjacent regions. The analytic model is validated by comparing its results with numerical modelling results and published data. It is then applied to two truncated cylinders with caisson cross sections, and results are given for the excitation forces and moments on each cylinder for different values of incident wave direction and spacing between the cylinders, and for different configurations.

Keywords: Wave diffraction; Wave excitation force; Wave-structure interaction; Truncated cylinders; Potential flow; Analytical model

1. Introduction

There are many offshore structures that are composed of an array of cylinders, e.g., marine drilling platforms, floating airports, bridge pylons, offshore wind farms and wave farms [1]. For this reason the study of wave diffraction by multiple cylinders has sparked tremendous interest from engineers and researchers. When the cylinders in the array are far away from one another, the hydrodynamic interaction between them may be expected to be negligible; in such circumstances, the wave forces acting on each cylinder in the array are similar to those acting on an isolated cylinder.

Wave diffraction by a single cylinder with circular cross section has been widely investigated. As early as 1971, Garrett [2] expanded an incident plane wave using Bessel functions and conducted an analytic study on the scattering of waves by a circular dock, in which a series of eigen-functions were applied to express the velocity potential and calculate wave forces. Black, Mei and Bray [3] applied Haskind's theorem to evaluate the wave forces acting on a fixed vertical truncated circular cylinder, which can be either partially immersed in the free surface or resting on the seabed with its height completely submerged, with only far-field properties. The vertical wave force acting on the floating truncated cylinder was seen to approach the additional hydrostatic force when the wave number tended to zero due to the free surface elevation, whereas the vertical force acting on the bottom-mounted cylinder became negligible as the wave number tended to zero, for the cylinder had a vanishing water plane area. Wave diffraction from a circular cylinder in other situations, e.g., located over a cylindrical barrier, floating in water of infinite depth, located in front of a vertical wall, horizontal and submerged, were extensively investigated [4-15] and brief reviews of the diffraction problems can also be found in our previous work [11, 12, 16].

In addition to the case of a cylinder of circular cross section, wave diffraction from a cylinder of elliptic cross section has also attracted some attention. The exact analytic solution of wave diffraction by a bottom-mounted, surface-piercing elliptic cylinder was first presented by Chen

1 and Mei [17]. In their study, the governing Laplace equation was expressed in elliptic cylindrical
2 coordinates; therefore, the fluid velocity potential was written in terms of infinite series of
3 Mathieu functions. This complete solution was considered too complex and costly for engineering
4 applications[18]. To reduce the time required by the complete solution, Williams [18] presented
5 two approximate solutions for the diffraction problem and the calculation of the wave excitation
6 forces and moments on the surface-piercing elliptic cylinder. For a stationary cylinder of elliptic
7 shape, partially immersed, the hydrodynamic loading was analytically investigated by Chen and
8 Mei [19] based on linearized shallow water wave theory and adopting a depth-averaged velocity
9 potential, i.e., the velocity potentials in each region of the fluid domain were bidimensional,
10 without consideration of the vertical coordinate in the matching procedure (2DH). The
11 shallow-water theory was also employed by Williams [20] to study diffraction from a stationary
12 elliptic breakwater either partially immersed or totally submerged and resting on the sea-bed. Later,
13 these problems were re-investigated without the shallow-water restriction [21]; therefore, in
14 addition to the angular coordinates, the vertical coordinate was retained in the analysis. The
15 theoretical solution of the interaction of linearized waves with a submerged horizontal disk of
16 elliptic cross section can be found in Zhang and Williams [22].

17 As regards cylinders with other cross-sections, a cosine-type cross-section was investigated
18 by Mansour, Williams and Wang [23], who presented a leading order analytic solution for a
19 uniform, bottom-mounted, surface-piercing cylinder based on a perturbation theory, in terms of
20 the amplitude of the perturbation from a circular cross-section. Their analytic results were found to
21 be in good agreement with numerical results only for small values of the perturbation amplitude.
22 More recently, the linear wave diffraction by a vertical, uniform, surface piercing cylinder with an
23 arbitrary smooth cross-section was analytically solved by Liu, Guo and Li [24], Liu, Guo, Fang, Li,
24 Hu and Liu [25]. The Fourier series method combined with the Galerkin method were used to
25 satisfy the wetted surface body conditions and continuity conditions between adjacent subdomains.
26 Alternatively, Dişibüyük, Korobkin and Yilmaz [26] solved wave diffraction from a uniform
27 vertical cylinder of arbitrary cross section by using an asymptotic approach, in which a fifth-order
28 asymptotic expansion of the velocity potential was substituted in the boundary condition. The
29 agreement between their theoretical predictions of the hydrodynamic forces and wave run-up and
30 those from Liu, Guo and Li [24] was shown to be fairly good.

31 For the majority of offshore structures that can be assimilated to an array of cylinders of
32 arbitrary cross-sections, in practice, the spacing between the cylinders is typically not large
33 enough for hydrodynamic interactions to be ignored; it follows that the wave excitation forces and
34 moments acting on each cylinder are strongly affected by the waves diffracted from the others
35 [27].

36 To analyse the hydrodynamic interaction occurring between multiple circular cylinders,
37 Kagemoto and Yue [28], Alliney [29] developed an interaction theory, which can be used to
38 predict wave exciting forces given only the diffraction characteristics of individual members. This
39 theory was also extended by Yilmaz and Incecik [30], Yilmaz [31] and Siddorn and Eatock Taylor
40 [32] to solve the problems of wave diffraction and radiation from an array of truncated vertical
41 circular cylinders. Linton and Evans [33] applied a direct method to wave diffraction problem of
42 multiple circular uniform cylinders and obtained new formulae for the wave excitation forces and
43 free-surface elevation close to a particular cylinder. Recently, Zheng and Zhang [34] presented a
44 theoretical study on a hybrid wave energy converter, in which an analytic model was proposed to

1 solve the problems of wave diffraction and radiation from a hollow cylinder and a surrounding
 2 array of solid cylinders. Analytic solutions of the hydrodynamic problems from a hybrid wave
 3 farm consisting of an array of truncated cylinders with and without moonpools were derived as
 4 well [35]. Other studies regarding wave diffraction of circular cylinders can be found in the review
 5 presented by Eatock Taylor [36].

6 With regard to an array of elliptic uniform cylinders, Chatjigeorgiou and Mavrakos [37]
 7 presented a semi-analytic model for the hydrodynamic diffraction. In their model, the Mathieu
 8 function addition theorem was adopted and properly extended so that it can be expressed in terms
 9 of the even and odd periodic and radial Mathieu functions. Later, Chatjigeorgiou [38] provided an
 10 analytic solution of hydrodynamic interactions between elliptic and circular uniform cylinders, in
 11 which the circular cylinders were considered as different geometries rather than special cases of
 12 elliptic cylinders with zero elliptic eccentricity. The theoretical model is more comprehensive,
 13 requiring the implementation of both Mathieu and Bessel functions; in exchange, this approach
 14 allows for efficient and accurate computations. Chatjigeorgiou [39] extended the research work by
 15 Chatjigeorgiou and Mavrakos [37] to multiple elliptic truncated cylinders. Chen and Lee [40]
 16 solved wave scattering from an array of four identical elliptical cylinders in a semi-analytical
 17 manner. Both physical (near-trapped mode) and mathematical (fictitious frequency) resonances
 18 were observed in their study. More recently, Zheng, Zhang, Liu and Iglesias [41] presented a
 19 semi-analytic model to solve the problem of wave radiation from cylinders with arbitrary cross
 20 sections oscillating independently in the absence of an incident wave.

21 To the authors' best knowledge, there has been no analytic research work reported on wave
 22 scattering from an array of cylinders with arbitrary cross sections – a relevant problem in Ocean
 23 Engineering, and the subject of this paper. More specifically, we focus on wave diffraction from
 24 multiple stationary truncated cylinders partially immersed in the free surface, and propose an
 25 analytic model based on linear potential flow theory to solve the diffraction problem and evaluate
 26 the excitation forces and moments acting on each cylinder.

27 2. Mathematical model

28 The problem geometry is illustrated in Fig. 1. An array of N ($N \geq 2$) vertical cylinders with
 29 arbitrary cross sections are partially immersed in water of finite depth h . The draft of cylinder n
 30 ($n=1,2,\dots,N$) is denoted as d_n . To describe the problem clearly, as shown in Fig. 1a, a Cartesian
 31 coordinate system $Oxyz$ is defined with the plane of Oxy coinciding with the still water level
 32 (SWL) and the Oz pointing upwards. The multiple cylinders are subjected to a train of regular
 33 gravity waves of amplitude A and angular frequency ω incoming at angle β to the positive
 34 x -direction. The amplitude A is assumed to be small compared to the wavelength; in other words,
 35 wave steepness is assumed to be small. Apart from the $Oxyz$ system, N cylindrical coordinates are
 36 employed with the origins set inside the cross section of each cylinder at SWL. The cylindrical
 37 coordinate corresponding to cylinder n is denoted as $O_n r_n \theta_n z_n$ with the origin O_n , located at $(x_n, y_n, 0)$
 38 in the $Oxyz$ system. A point (x_n, y_n, z_n) in the $Oxyz$ system is used as the reference point to calculate
 39 the wave excitation moments acting on cylinder n . The fluid is divided into $N+1$ regions (Fig. 1b):
 40 the first N regions are the interior regions below each cylinder; Region $N+1$ denotes the exterior
 41 region, extending to infinity in the horizontal plane.

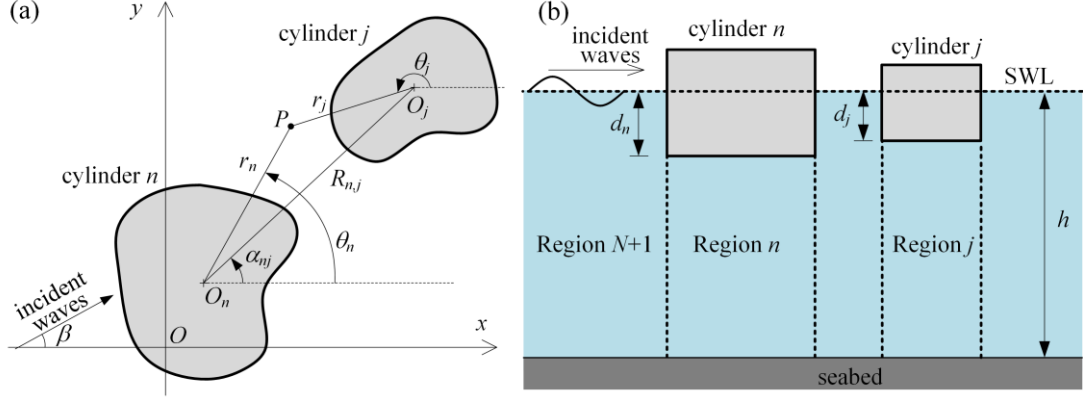

Fig. 1. Definition sketch: (a) plan view; (b) side view

The shape of the cross section of cylinder n can be described in its own cylindrical coordinate system $O_n r_n \theta_n z$ as $r_n = R_n(\theta_n)$, which represents the radius of any point at the edge of cross section at θ_n . In order to describe the unit normal vector at the side surface of cylinder n , S_n function is introduced as:

$$S_n(r_n, \theta_n) = r_n - R_n(\theta_n), \quad (1)$$

in which $S_n=0$ represents the cross section of cylinder n as well, and the unit normal vector pointing into the water at the side surface in the $O_n r_n \theta_n z$ system and the $Oxyz$ system can be written as Eqs. (2a) and (2b), respectively[16, 24, 41]:

$$\vec{n} = \frac{1}{\sqrt{1 + \left(\frac{1}{r_n} \frac{\partial S_n}{\partial \theta_n}\right)^2}} \left(\vec{e}_{r,n} + \frac{1}{r_n} \frac{\partial S_n}{\partial \theta_n} \vec{e}_{\theta,n} + 0\vec{e}_z \right), \quad (2a)$$

$$\vec{n} = \frac{1}{\sqrt{1 + \left(\frac{1}{r_n} \frac{\partial S_n}{\partial \theta_n}\right)^2}} \left(\left(\cos \theta_n - \frac{1}{r_n} \frac{\partial S_n}{\partial \theta_n} \sin \theta_n \right) \vec{i} + \left(\sin \theta_n + \frac{1}{r_n} \frac{\partial S_n}{\partial \theta_n} \cos \theta_n \right) \vec{j} + 0\vec{k} \right),$$

(2b)

where $(\vec{e}_{r,n}, \vec{e}_{\theta,n}, \vec{e}_z)$ are the unit basis vectors in the $O_n r_n \theta_n z$ system, and $(\vec{i}, \vec{j}, \vec{k})$ are the unit basis vectors in the $Oxyz$ system.

Assuming the fluid to be incompressible and inviscid, the irrotational fluid motion excited by regular waves with small amplitude might be described by using linear flow potential theory and the velocity potential can be written as $\varphi(x,y,z,t) = \text{Re}[\Phi(x,y,z)e^{-i\omega t}]$, where t is the time, i is the imaginary unit, Φ is a complex spatial velocity potential. It follows that both φ and Φ satisfy the Laplace equation everywhere in the fluid domain.

In the frame of the linear flow theory, the spatial velocity potential Φ can be separated into contributions from the incident wave field and the diffracted field as:

$$\Phi = \Phi_I + \Phi_D, \quad (3)$$

where Φ_I and Φ_D represent the incident wave spatial potential and the diffracted one, respectively. Both of them satisfy the Laplace equation.

Generally, the velocity spatial potential for the undisturbed incident waves is well known and

1 Φ_1 in the $O_n r_n \theta_n z$ system can be written as [34, 35]:

$$2 \quad \Phi_1 = -\frac{igA \cosh[k_0(z+h)]}{\omega \cosh(k_0 h)} e^{ik_0(x_n \cos \beta + y_n \sin \beta)} \sum_{m=-\infty}^{\infty} i^m e^{-im\beta} J_m(k_0 r_n) e^{im\theta_n}, \quad (4)$$

3 where k_0 is the wave number satisfying the dispersion relation $\omega^2 = gk_0 \tanh(k_0 h)$, in which g is the
4 gravity acceleration; J_m is the Bessel function of order m .

5 The boundary conditions for Φ_D can be written as follows:

6 1) The linear free surface condition:

$$7 \quad \frac{\partial \Phi_D}{\partial z} - \frac{\omega^2}{g} \Phi_D = 0, \quad z = 0 \quad \text{and} \quad r_n \geq R_n \quad (5)$$

8 2) The non-penetrating condition on the seabed:

$$9 \quad \frac{\partial \Phi_D}{\partial z} = 0, \quad z = -h \quad (6)$$

10 3) The surface condition at the wetted surface of each cylinder:

$$11 \quad \frac{\partial \Phi_D}{\partial z} = -\frac{\partial \Phi_1}{\partial z}, \quad z = -d_n \quad \text{and} \quad 0 \leq r_n \leq R_n \quad (7)$$

$$12 \quad \frac{\partial \Phi_D}{\partial n} = -\frac{\partial \Phi_1}{\partial n}, \quad -d_n \leq z \leq 0 \quad \text{and} \quad r_n = R_n \quad (8)$$

13 4) The radiation condition at infinity:

$$14 \quad \sqrt{k_0 r_n} \left(\frac{\partial \Phi_D}{\partial r_n} - ik_0 \Phi_D \right) = 0, \quad r_n \rightarrow \infty \quad (9)$$

15 3 Solution to diffracted potentials

16 The diffracted spatial potential in Region n is denoted as $\Phi_{D,n}$. The method of separation of
17 variables is applied in each region in order to obtain expressions for the unknown diffracted
18 potentials.

19 3.1 Diffracted spatial potentials in different regions

20 1) Region n ($n=1, 2, \dots, N$)

21 The diffracted spatial potential in Region n can be written in the $O_n r_n \theta_n z$ system as

$$22 \quad \Phi_{D,n}(r_n, \theta_n, z) = \Phi_{D,n,p} + \sum_{m=-\infty}^{\infty} \left[A_{m,0}^{D,n} (r_n)^{|m|} + \sum_{l=1}^{\infty} A_{m,l}^{D,n} I_m(\beta_{n,l} r_n) \cos[\beta_{n,l}(z+h)] \right] e^{im\theta_n}, \quad (10)$$

23 where $A_{m,l}^{D,n}$ are unknown coefficients to be solved in Section 3.2; I_m is the modified Bessel
24 function of first kind and order m ; $\beta_{n,l}$ is the eigenvalue which is given by

$$25 \quad \beta_{n,l} = \frac{l\pi}{h-d_n}, \quad l=0, 1, 2, 3, \dots, \quad (11)$$

26 $\Phi_{D,n,p}$ is a particular solution, $\Phi_{D,n,p} = -\Phi_1$.

1 2) Region $N+1$

2 In Region $N+1$, i.e., the exterior domain, the diffracted spatial potential can be decomposed
3 into the contributions from the waves diffracted from the N cylinders:

$$4 \quad \Phi_{D,N+1} = \sum_{n=1}^N \Phi_n^{D,e}, \quad (12)$$

5 in which $\Phi_n^{D,e}$ represents the diffracted potential corresponding to the waves travelling outwards
6 from cylinder n and can be written in terms of eigen-function expansion in the $O_n r_n \theta_n z$ system as:

$$7 \quad \Phi_n^{D,e}(r_n, \theta_n, z) = \sum_{m=-\infty}^{\infty} \left[B_{m,0}^{D,n} H_m(k_0 r_n) \frac{Z_0(z)}{Z_0(0)} + \sum_{l=1}^{\infty} B_{m,l}^{D,n} K_m(k_l r_n) \frac{Z_l(z)}{Z_l(0)} \right] e^{im\theta_n} \quad (13)$$

8 where

$$9 \quad Z_0(z) = N_0^{-1/2} \cosh[k_0(z+h)]; \quad Z_l(z) = N_l^{-1/2} \cos[k_l(z+h)]; \quad (14)$$

$$10 \quad N_0 = \frac{1}{2} \left[1 + \frac{\sinh(2k_0 h)}{2k_0 h} \right]; \quad N_l = \frac{1}{2} \left[1 + \frac{\sin(2k_l h)}{2k_l h} \right]; \quad (15)$$

11 $B_{m,l}^{D,n}$ are the unknown coefficients to be solved in Section 3.2; H_m is the Hankel function of
12 first kind of order m ; K_m is the modified Bessel function of second kind of order m ; k_l is the
13 eigenvalue which is given by

$$14 \quad \omega^2 = -k_l g \tan(k_l h), \quad l=1,2,3, \dots \quad (16)$$

15 With the employment of Graf's addition theorem for Bessel functions [11, 12, 28, 32, 34, 42],
16 $\Phi_j^{D,e}$ can be expressed in different cylindrical coordinate systems, and when $r_n \leq R_{jn}$, Eq. (12) can
17 be rewritten in the $O_n r_n \theta_n z$ system as:

$$18 \quad \begin{aligned} \Phi_{D,N+1}(r_n, \theta_n, z) = & \sum_{m=-\infty}^{\infty} \left[B_{m,0}^{D,n} H_m(k_0 r_n) \frac{Z_0(z)}{Z_0(0)} + \sum_{l=1}^{\infty} B_{m,l}^{D,n} K_m(k_l r_n) \frac{Z_l(z)}{Z_l(0)} \right] e^{im\theta_n} \\ & + \sum_{\substack{j=1 \\ j \neq n}}^N \sum_{m=-\infty}^{\infty} \left\{ B_{m,0}^{D,j} \frac{Z_0(z)}{Z_0(0)} \sum_{m'=-\infty}^{\infty} (-1)^{m'} H_{m-m'}(k_0 R_{jn}) J_{m'}(k_0 r_n) e^{i(m\alpha_{jn}-m'\alpha_{nj})} e^{im'\theta_n} \right. \\ & \left. + \sum_{l=1}^{\infty} B_{m,l}^{D,j} \frac{Z_l(z)}{Z_l(0)} \sum_{m'=-\infty}^{\infty} K_{m-m'}(k_l R_{jn}) I_{m'}(k_l r_n) e^{i(m\alpha_{jn}-m'\alpha_{nj})} e^{im'\theta_n} \right\} \end{aligned} \quad (17)$$

19 3.2 Method of computation for unknown coefficients

20 The unknown coefficients in Eqs. (10), (13) and (17) can be determined by using the
21 conditions of continuity of pressure and mass flux at $r_n=R_n$ ($n=1,2,\dots,N$):

22 1) Continuity of pressure at the boundary $S_n=0$:

$$23 \quad \Phi_{D,N+1} \Big|_{S_n=0} = \Phi_{D,n} \Big|_{S_n=0}, \quad -h < z < -d_n. \quad (18)$$

24 2) Continuity of mass flux at the boundary $S_n=0$:

$$1 \quad \left. \frac{\partial \Phi_{D,N+1}(r_n, \theta_n, z)}{\partial n} \right|_{S_n=0} = \begin{cases} \left. -\frac{\partial \Phi_1(r_n, \theta_n, z)}{\partial n} \right|_{S_n=0}, & -d_n < z < 0 \\ \left. \frac{\partial \Phi_{D,n}(r_n, \theta_n, z)}{\partial n} \right|_{S_n=0}, & -h < z < -d_n \end{cases}, \quad (19a)$$

2 which, with the employment of Eq. (2a), can be further expressed in the frame of the local
3 cylindrical coordinate system $O_n r_n \theta_n z$ as

$$4 \quad \left(r_n^2 \frac{\partial \Phi_{D,N+1}}{\partial r_n} + \frac{\partial S_n}{\partial \theta_n} \frac{\partial \Phi_{D,N+1}}{\partial \theta_n} \right) \Big|_{S_n=0} = \begin{cases} -\left(r_n^2 \frac{\partial \Phi_1}{\partial r_n} + \frac{\partial S_n}{\partial \theta_n} \frac{\partial \Phi_1}{\partial \theta_n} \right) \Big|_{S_n=0}, & -d_n < z < 0 \\ \left(r_n^2 \frac{\partial \Phi_{D,n}}{\partial r_n} + \frac{\partial S_n}{\partial \theta_n} \frac{\partial \Phi_{D,n}}{\partial \theta_n} \right) \Big|_{S_n=0}, & -h < z < -d_n \end{cases}. \quad (19b)$$

5 After inserting the expressions of the wave diffracted spatial potential as given in Eqs. (10)
6 and (17) into Eqs. (18) and (19b), the terms with r_n and $\partial S_n / \partial \theta_n$ at $S_n=0$ are both found to be
7 dependent on θ_n , and can be expanded into a Fourier series as follows [41]:

$$8 \quad J_m(k_0 r_n) \Big|_{S_n=0} = \sum_{q=-\infty}^{\infty} f_{m,0,q}^{J,n} e^{iq\theta_n}; \quad \left(r_n^2 k_0 J'_m(k_0 r_n) + im J_m(k_0 r_n) \frac{\partial S_n}{\partial \theta_n} \right) \Big|_{S_n=0} = \sum_{q=-\infty}^{\infty} f_{m,0,q}^{J',n} e^{iq\theta_n} \quad (20a)$$

$$9 \quad H_m(k_0 r_n) \Big|_{S_n=0} = \sum_{q=-\infty}^{\infty} f_{m,0,q}^{H,n} e^{iq\theta_n}; \quad \left(r_n^2 k_0 H'_m(k_0 r_n) + im H_m(k_0 r_n) \frac{\partial S_n}{\partial \theta_n} \right) \Big|_{S_n=0} = \sum_{q=-\infty}^{\infty} f_{m,0,q}^{H',n} e^{iq\theta_n} \quad (20b)$$

$$10 \quad K_m(k_l r_n) \Big|_{S_n=0} = \sum_{q=-\infty}^{\infty} f_{m,l,q}^{K,n} e^{iq\theta_n}; \quad \left(r_n^2 k_l K'_m(k_l r_n) + im K_m(k_l r_n) \frac{\partial S_n}{\partial \theta_n} \right) \Big|_{S_n=0} = \sum_{q=-\infty}^{\infty} f_{m,l,q}^{K',n} e^{iq\theta_n} \quad (20c)$$

$$11 \quad I_m(k_l r_n) \Big|_{S_n=0} = \sum_{q=-\infty}^{\infty} f_{m,l,q}^{I,n} e^{iq\theta_n}; \quad \left(r_n^2 k_l I'_m(k_l r_n) + im I_m(k_l r_n) \frac{\partial S_n}{\partial \theta_n} \right) \Big|_{S_n=0} = \sum_{q=-\infty}^{\infty} f_{m,l,q}^{I',n} e^{iq\theta_n} \quad (20d)$$

$$12 \quad I_m(\beta_{n,l} r_n) \Big|_{S_n=0} = \sum_{q=-\infty}^{\infty} \tilde{f}_{m,l,q}^{I,n} e^{iq\theta_n}; \quad \left(r_n^2 \beta_{n,l} I'_m(\beta_{n,l} r_n) + im I_m(\beta_{n,l} r_n) \frac{\partial S_n}{\partial \theta_n} \right) \Big|_{S_n=0} = \sum_{q=-\infty}^{\infty} \tilde{f}_{m,l,q}^{I',n} e^{iq\theta_n} \quad (20e)$$

$$13 \quad (r_n)^{|m|} \Big|_{S_n=0} = \sum_{q=-\infty}^{\infty} f_{m,0,q}^{R,n} e^{iq\theta_n}; \quad \left(|m|(r_n)^{|m|+1} + im (r_n)^{|m|} \frac{\partial S_n}{\partial \theta_n} \right) \Big|_{S_n=0} = \sum_{q=-\infty}^{\infty} \tilde{f}_{m,0,q}^{R,n} e^{iq\theta_n} \quad (20f)$$

14 for $n=1 \dots N$, where the Fourier coefficients on the right-hand side of Eqs. (20a)~(20f), represented
15 by $\mathfrak{R}_{n,q}$ for convenience, can be obtained from

$$16 \quad \mathfrak{R}_{n,q} = \frac{1}{2\pi} \int_{-\pi}^{\pi} \Psi_{n,q}(\theta_n) e^{-iq\theta_n} d\theta_n, \quad (21)$$

17 in which $\Psi_{n,q}$ denotes the θ_n dependent items as given at the left side of Eqs. (20a)~(20f).

18 The orthogonal properties of the functions $\cos n\theta$, $\sin n\theta$, and $Z_\nu(z)$ can also be used by
19 multiplying Eqs. (18) and (19) with $e^{-i\tau\theta_n} \cos[\beta_{n,\zeta}(z+h)] / (h-d_n)$ and $e^{-i\tau\theta_n} Z_\zeta / h$,

1 respectively, on both sides and integrating with respect to θ and z , as follows:

$$2 \quad \int_{-\pi}^{\pi} \left[\int_{-h}^{-d_n} \Phi_{D,N+1}(r_n, \theta_n, z) \Big|_{S_n=0} \frac{\cos[\beta_{n,\zeta}(z+h)]}{h-d_n} dz \right] e^{-i\tau\theta_n} d\theta_n, \quad (22)$$

$$= \int_{-\pi}^{\pi} \left[\int_{-h}^{-d_n} \Phi_{D,n}(r_n, \theta_n, z) \Big|_{S_n=0} \frac{\cos[\beta_{n,\zeta}(z+h)]}{h-d_n} dz \right] e^{-i\tau\theta_n} d\theta_n,$$

$$3 \quad \int_{-\pi}^{\pi} \left[\int_{-h}^0 \frac{\partial \Phi_{D,N+1}(r_n, \theta_n, z)}{\partial n} \Big|_{S_n=0} \frac{Z_{\zeta}(z)}{h} dz \right] e^{-i\tau\theta_n} d\theta_n, \quad (23)$$

$$= \int_{-\pi}^{\pi} \left[\int_{-h}^{-d_n} \frac{\partial \Phi_{D,n}(r_n, \theta_n, z)}{\partial n} \Big|_{S_n=0} \frac{Z_{\zeta}(z)}{h} dz - \int_{-d_n}^0 \frac{\partial \Phi_1(r_n, \theta_n, z)}{\partial n} \Big|_{S_n=0} \frac{Z_{\zeta}(z)}{h} dz \right] e^{-i\tau\theta_n} d\theta_n,$$

4 in which τ is an integer which varies from minus infinity to plus infinity, and ζ is an integer
5 varying from zero to plus infinity.

6 Substituting the expressions for the wave diffracted spatial potential in Eqs. (10) and (17),
7 inserting the Fourier coefficients in Eqs. (20a)~(20f) into Eqs. (22) and (23), and making some
8 rearrangements, we have

$$9 \quad - \sum_{m=-\infty}^{\infty} A_{m,\tau,\zeta}^{1,n} A_{m,\zeta}^{D,n} + \sum_{m=-\infty}^{\infty} \sum_{l=0}^{\infty} B_{m,l}^{D,n} L_{l,\zeta}^{(n)} A_{m,\tau,l}^{2,n} + \sum_{\substack{j=1 \\ j \neq n}}^N \sum_{m=-\infty}^{\infty} \sum_{l=0}^{\infty} B_{m,l}^{D,j} L_{l,\zeta}^{(n)} T_{m,\tau,l}^{n,j}, \quad (24)$$

$$= \frac{igA}{\omega} L_{0,\zeta}^{(n)} e^{ik_0(x_n \cos \beta + y_n \sin \beta)} \sum_{m=-\infty}^{\infty} i^m e^{-im\beta} f_{m,0,\tau-m}^{J,n}$$

$$10 \quad - \frac{h-d_n}{h} Z_{\zeta}(0) \sum_{m=-\infty}^{\infty} \sum_{l=0}^{\infty} A_{m,l}^{D,n} L_{\zeta,l}^{(n)} A_{m,\tau,l}^{3,n} + \sum_{m=-\infty}^{\infty} B_{m,\zeta}^{D,n} A_{m,\tau,\zeta}^{4,n} + \sum_{\substack{j=1 \\ j \neq n}}^N \sum_{m=-\infty}^{\infty} B_{m,\zeta}^{D,j} T_{m,\tau,\zeta}^{n,j}, \quad (25)$$

$$= \frac{igA}{\omega} \frac{\delta_{0,\zeta}}{Z_0(0)} e^{ik_0(x_n \cos \beta + y_n \sin \beta)} \sum_{m=-\infty}^{\infty} i^m e^{-im\beta} f_{m,0,\tau-m}^{J',n}$$

11 where

$$12 \quad A_{m,\tau,\zeta}^{1,n} = \begin{cases} f_{m,\zeta,\tau-m}^{R,n}, & \zeta = 0 \\ \frac{1}{2} \tilde{f}_{m,\zeta,\tau-m}^{I,n}, & \zeta = 1, 2, 3, \dots \end{cases} \quad A_{m,\tau,l}^{2,n} = \begin{cases} f_{m,0,\tau-m}^{H,n}, & l = 0 \\ f_{m,l,\tau-m}^{K,n}, & l = 1, 2, 3, \dots \end{cases}, \quad (26)$$

$$13 \quad L_{l,\zeta}^{(n)} = \frac{1}{h-d_n} \int_{-h}^{-d_n} \frac{Z_l(z) \cos[\beta_{n,\zeta}(z+h)]}{Z_l(0)} dz$$

$$= \begin{cases} \frac{(-1)^{\zeta} (h-d_n) k_0 \sinh[k_0(h-d_n)]}{[(h-d_n)^2 k_0^2 + \zeta^2 \pi^2] \cosh(k_0 h)} & l = 0; \zeta = 0, 1, 2, \dots \\ \frac{(-1)^{\zeta} (h-d_n) k_l \sin[k_l(h-d_n)]}{[(h-d_n)^2 k_l^2 - \zeta^2 \pi^2] \cos(k_l h)} & l = 1, 2, 3, \dots; \zeta = 0, 1, 2, \dots \end{cases}, \quad (27)$$

$$T_{m,\tau,l}^{n,j} = \begin{cases} \sum_{m'=-\infty}^{\infty} (-1)^{m'} H_{m-m'}(k_0 R_{jn}) f_{m',0,\tau-m'}^{J,n} e^{i(m\alpha_{jn}-m'\alpha_{nj})}, & l=0 \\ \sum_{m'=-\infty}^{\infty} K_{m-m'}(k_l R_{jn}) f_{m',l,\tau-m'}^{I,n} e^{i(m\alpha_{jn}-m'\alpha_{nj})}, & l=1,2,3,\dots \end{cases}, \quad (28)$$

$$A_{m,\tau,l}^{3,n} = \begin{cases} \tilde{f}_{m,0,\tau-m}^{R,n}, & l=0 \\ \tilde{f}_{m,l,\tau-m}^{I',n}, & l=1,2,3,\dots \end{cases} \quad A_{m,\tau,\zeta}^{4,n} = \begin{cases} \frac{f_{m,0,\tau-m}^{H',n}}{Z_0(0)}, & \zeta=0 \\ \frac{f_{m,\zeta,\tau-m}^{K',n}}{Z_\zeta(0)}, & \zeta=1,2,3,\dots \end{cases}. \quad (29)$$

$$T_{m,\tau,l}^{In,j} = \begin{cases} \frac{1}{Z_0(0)} \sum_{m'=-\infty}^{\infty} (-1)^{m'} H_{m-m'}(k_0 R_{jn}) f_{m',0,\tau-m'}^{J',n} e^{i(m\alpha_{jn}-m'\alpha_{nj})}, & l=0 \\ \frac{1}{Z_l(0)} \sum_{m'=-\infty}^{\infty} K_{m-m'}(k_l R_{jn}) f_{m',l,\tau-m'}^{I',n} e^{i(m\alpha_{jn}-m'\alpha_{nj})}, & l=1,2,3,\dots \end{cases}, \quad (30)$$

We truncate $(2M+1)$ terms ($m=-M, \dots, 0, \dots, M$) and $(L+1)$ terms ($l=0, 1, \dots, L$) in Eqs. (10), (13), (24) and (25) and take $(\tau=-M, \dots, 0, \dots, M)$ and $(\zeta=0, 1, \dots, L)$ in Eqs. (24) and (25) as well, thus a $2N(2M+1)(L+1)$ -order complex linear equation matrix is obtained, which can be used to calculate the same number of unknown coefficients $A_{m,l}^{D,n}$ and $B_{m,l}^{D,n}$. In the following analytic computations, $M=15$ and $L=8$ are taken so as to obtain accurate results.

4 Wave excitation forces and moments

The hydrodynamic pressure in the flow domain is given by the linearized Bernoulli equation, $p=-\rho\partial\text{Re}[(\Phi_1+\Phi_D)e^{-i\omega t}]/\partial t=\rho\text{Re}[i\omega(\Phi_1+\Phi_D)e^{-i\omega t}]$, where ρ represents the water density. Therefore, the generalized excitation force on cylinder n in Mode j ($j=1\sim 6$ represent surge, sway, heave, roll, pitch and yaw, respectively) can be calculated from $\text{Re}\left[F_{e,n}^{(j)}e^{-i\omega t}\right]$, where

$$F_{e,n}^{(j)} = -i\omega\rho\int_{S_n} (\Phi_1 + \Phi_D) n_j ds, \quad (31)$$

in which S_n is the wetted surface of cylinder n ; $n_1=n_x, n_2=n_y, n_3=n_z, n_4=-(z-z_n)n_y+(y-y_n)n_z, n_5=(z-z_n)n_x-(x-x_n)n_z, n_6=-(y-y_n)n_x+(x-x_n)n_y, \vec{n} = n_x\vec{i} + n_y\vec{j} + n_z\vec{k}$ is the unit normal vector directed into the fluid domain at the cylinder surface, as given in Eq. (2b).

The analytic expressions for the diffracted potentials of the whole computational domain are obtained in Section 3, so the wave excitation forces and moments can be calculated directly from Eq. (31).

5 Model validation

Multiple caissons arise in many offshore projects, such as floating bridges [43] and mobile offshore bases [1]. In this section, the case of two caissons (Fig. 2) is used for validating the analytic model of wave diffraction from multiple truncated cylinders of arbitrary cross sections. Located in water with a depth of $h=20$ m, the two caissons have the same dimensions and a draft $d_n=5$ m. They are deployed in parallel at a distance from each other $e=20$ m, and are subjected to regular waves propagating at an angle $\beta=\pi/6$.

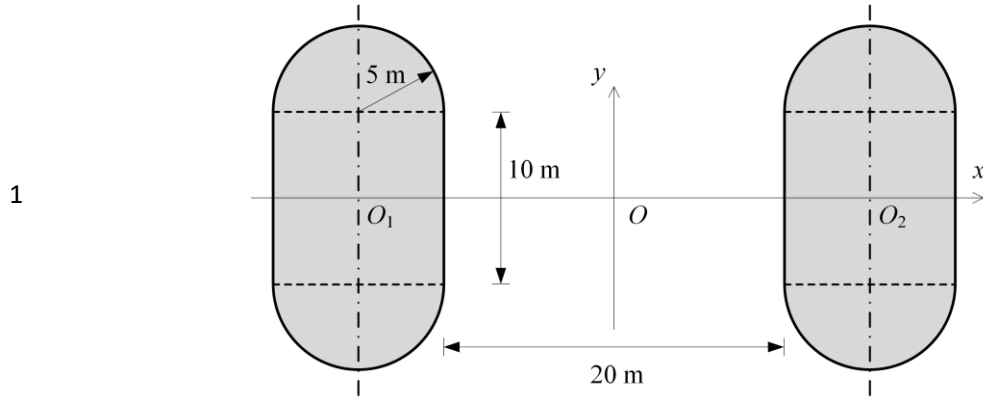

Fig. 2. Top view of the two caissons, case study used for validation.

4 After solving wave diffraction problem from these caissons, the wave excitation forces and
5 moments obtained are then normalized as follows:

6

$$\bar{F}_{e,n}^{(j)} = \frac{|F_{e,n}^{(j)}|}{\rho g A h^q}, \quad q = \begin{cases} 2, & j = 1, 2, 3 \\ 3, & j = 4, 5, 6 \end{cases}, \quad (32a)$$

7

$$\varphi_{e,n}^{(j)} = \arg F_{e,n}^{(j)}. \quad (32b)$$

8 Hereinafter, k_0 is denoted as k for simplicity, and the nondimensional wave frequency kh is used.

9 Figures 3 and 4 present a comparison of the present analytic results of wave excitation
10 forces/moments acting on the two caissons (see Fig.2) for different wave frequencies ($0 < kh < 5.0$)
11 with the numerical results from BEM-based software, ANSYS-AQWA [44]. Figs. 3a and 3b show
12 the wave excitation forces acting on Caisson 1 in terms of dimensionless amplitude and phase
13 angle, respectively. The wave excitation forces acting on Caisson 2 are plotted in Figs. 3c and 3d.
14 Similarly, the excitation moments loading on Caissons 1 and 2 are illustrated in Figs. 4a~4b and
15 Figs. 4c~4d, respectively.

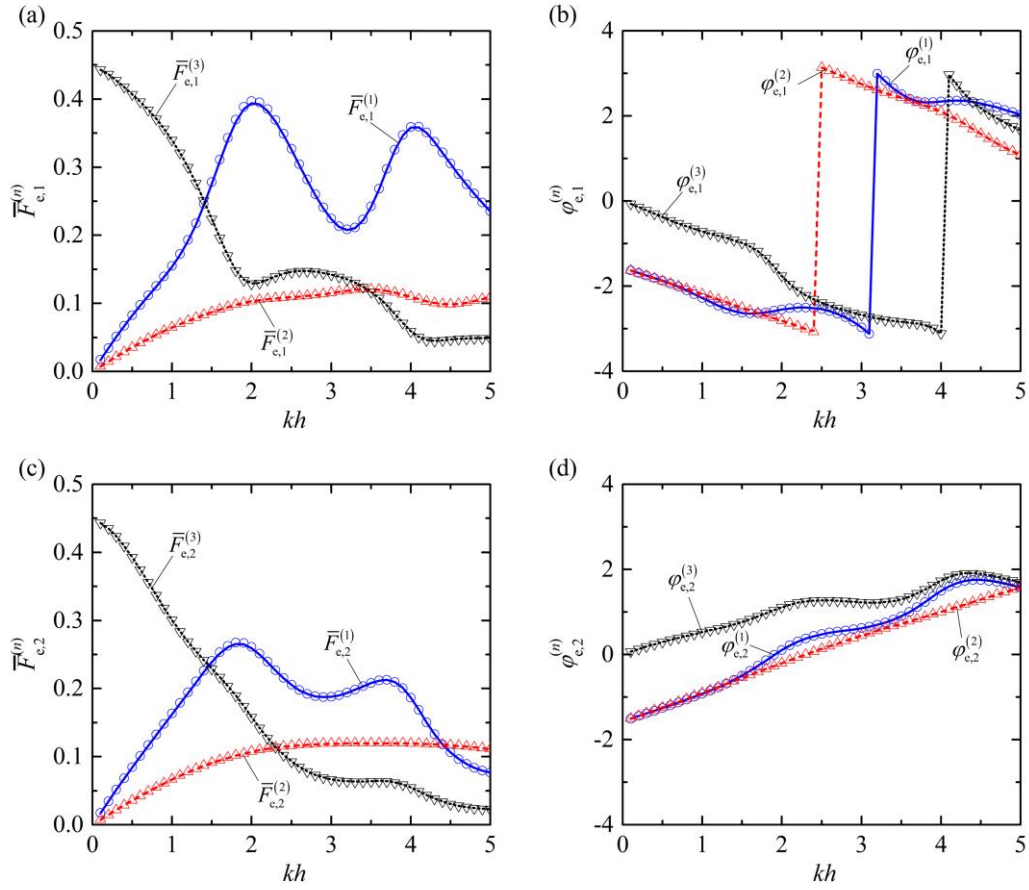

1

2 Fig. 3. Comparison of the present analytic results of wave excitation forces acting on the two
 3 caissons with the numerical results based on BEM for $\beta=\pi/6$ and $e/h=1.0$: (a) $\bar{F}_{e,1}^{(n)}$, $n=1,2,3$; (b)
 4 $\phi_{e,1}^{(n)}$, $n=1,2,3$; (c) $\bar{F}_{e,2}^{(n)}$, $n=1,2,3$; (d) $\phi_{e,1}^{(n)}$, $n=1,2,3$. [Lines: analytic results;
 5 symbols: numerical
 6 results].

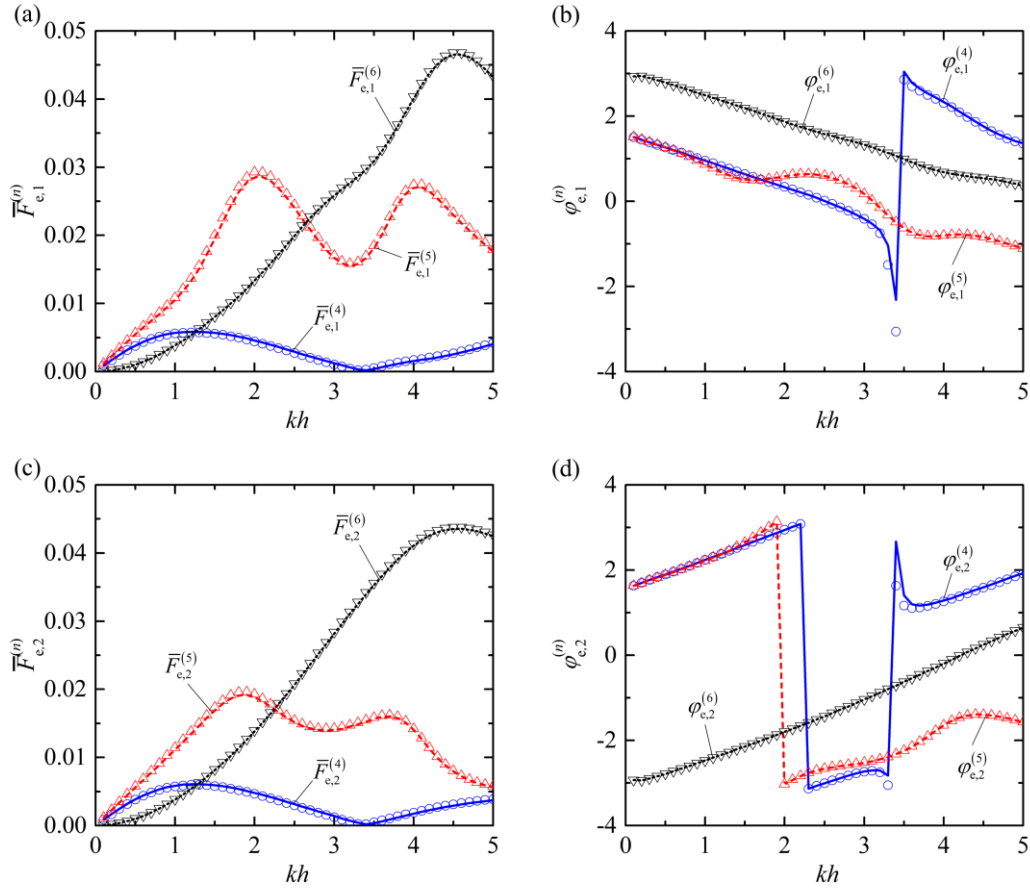

1
2
3
4
5
6

Fig. 4. Comparison of the present analytic results of wave excitation moments acting on the two caissons with the numerical results based on BEM for $\beta=\pi/6$ and $e/h=1.0$: (a) $\bar{F}_{e,1}^{(n)}$, $n=4,5,6$; (b) $\varphi_{e,1}^{(n)}$, $n=4,5,6$; (c) $\bar{F}_{e,2}^{(n)}$, $n=4,5,6$; (d) $\varphi_{e,2}^{(n)}$, $n=4,5,6$. [Lines: analytic results; symbols: numerical results].

7 It is shown that the analytic results of the excitation forces and moments acting on each
8 caisson in all modes, i.e., surge, sway, heave, roll, pitch and yaw, fully agree with the numerical
9 results in terms of both dimensionless amplitude and phase angle. This excellent agreement
10 validates the present analytic model.

11 In addition to the two caissons with a quasi-elliptical cross section, a square array of four
12 identical elliptical cylinders studied analytically by Chen and Lee [40] is selected to validate the
13 present analytic model. All cylinders are fixed on the seabed mounted upward to the free surface. The
14 half lengths of the major and the minor axes of each elliptical cylinder are h and $0.5h$, respectively.
15 The incident wave direction is $\beta=0$. In the present computation, $d_n=0.98h$ ($n=1, 2, 3, 4$) was
16 adopted to represent that the cylinders were bottom-mounted. As shown in Fig. 5, the present
17 results of the surge wave excitation forces are in excellent agreement with those in [40].

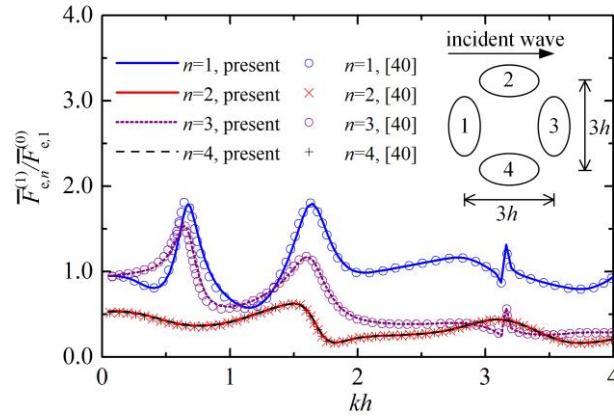

1
2 Fig. 5. Comparison of the present analytic results of the surge wave excitation forces acting
3 on each cylinder of an array of four identical elliptical cylinders with the published data [40] for
4 $\beta=0$. [$\bar{F}_{e,1}^{(0)}$ denotes the surge wave excitation force acting on the cylinder-1 when it is in
5 isolation]

6 Results and discussion

7 In this section, the validated analytic model is applied to investigate the role of the incident
8 wave direction, spacing between caissons and configuration angle in the hydrodynamic forces and
9 moments acting on the two caissons depicted in Fig. 2.

10 6.1 Effect of incident wave angle

11 The two caissons suffering from incoming regular waves with five different incident wave
12 angles, i.e., $\beta=0, \pi/6, \pi/4, \pi/3$ and $\pi/2$, are tested. Figure 6 shows the variations of the excitation
13 forces acting on each caisson in surge, sway and heave modes with kh for different values of β and
14 $e/h=1.0$. Similarly, the results of the excitation moments in roll, pitch and yaw modes are
15 presented in Fig. 7.

16 Since both caissons have the same dimensions and are arranged in parallel symmetrically, the
17 results of the excitation forces and moments acting on them in any mode should be the same in
18 terms of amplitude when $\beta=\pi/2$. This is borne out by the results in Figs. 6 and 7.

19 For $\beta=\pi/2$, the surge excitation force, pitch and yaw excitation moments acting on the
20 isolated individual caisson vanish. By contrast, when two caissons are deployed in proximity (Fig.
21 2), the surge excitation force, and the pitch and yaw excitation moments acting on each caisson
22 may be non-zero due to the hydrodynamic interaction between the caissons. Note that for $kh=3.6$
23 and $\beta=\pi/4$, $\bar{F}_{e,1}^{(1)}$ and $\bar{F}_{e,2}^{(1)}$ are 0.056 and 0.282, respectively, implying that, under certain
24 circumstances, the wave excitation forces acting on the leeward caisson can be larger than those
25 acting on the windward caisson.

26 When incident waves propagate along the x -axis, i.e., $\beta=0$, due to the symmetrical property
27 of the two caissons about the plane of $y=0$, $\bar{F}_{e,n}^{(2)}$, $\bar{F}_{e,n}^{(4)}$ and $\bar{F}_{e,n}^{(6)}$ all vanish (Figs. 6c, 6d, 7a ,
28 7b, 7e and 7f). For $kh<3.5$, the larger the β , the larger the $\bar{F}_{e,1}^{(2)}$ and $\bar{F}_{e,2}^{(2)}$. This also applies to
29 the effect of β on $\bar{F}_{e,1}^{(4)}$ and $\bar{F}_{e,2}^{(4)}$ for $kh<3.5$.

30 β might play opposite roles on $\bar{F}_{e,1}^{(3)}$ for different wave frequencies. For $kh<1.0$, a larger β
31 results in a smaller $\bar{F}_{e,1}^{(3)}$. Whereas for $1.5<kh<1.8$, a larger $\bar{F}_{e,1}^{(3)}$ is obtained for a larger β . For
32 $2.0<kh<5.0$, at least one peak of $\bar{F}_{e,1}^{(3)}$ - kh occurs for any β studied, except $\beta=\pi/2$. The kh

1 corresponding to the peaks is rather dependent on β . As a comparison, although peaks also appear
 2 for $\bar{F}_{e,2}^{(3)}-kh$ at $2.0 < kh < 5.0$, the kh values where peaks occur are rather independent of β .

3 When the caissons are subjected to oblique waves, i.e., $\beta=\pi/6, \pi/4$ and $\pi/3$, $\bar{F}_{e,1}^{(4)}$ and $\bar{F}_{e,2}^{(4)}$
 4 are found to vanish for certain wave conditions (Figs.7a and 7b). Such circumstances are welcome
 5 from the standpoint of offshore structures' stability. It may be inferred that the larger the β , the
 6 larger the kh where $\bar{F}_{e,1}^{(4)}$ and $\bar{F}_{e,2}^{(4)}$ vanish.

7 The effect of β on pitch moments is found to be similar to that on surge forces (Figs.7c and
 8 7d). This may be partially due to the position of the rotational reference point, which is located at
 9 SWL, implying that the arm of the surge force is generally larger than the arm of the heave force;
 10 therefore, the pitch moment is dominated by the part of the surge force acting on the side walls.

11 Although $\bar{F}_{e,1}^{(6)}$ ($\bar{F}_{e,2}^{(6)}$) is excited for $\beta=\pi/2$ due to hydrodynamic interaction between the
 12 caissons, its value is rather small (Figs.7e and 7f). $\bar{F}_{e,1}^{(6)}$ ($\bar{F}_{e,2}^{(6)}$) are mainly excited in oblique
 13 incoming waves. For $kh < 3.8$, $\bar{F}_{e,1}^{(6)}$ and $\bar{F}_{e,2}^{(6)}$ for $\beta=\pi/4$ are both larger than the other cases with
 14 different value of β .

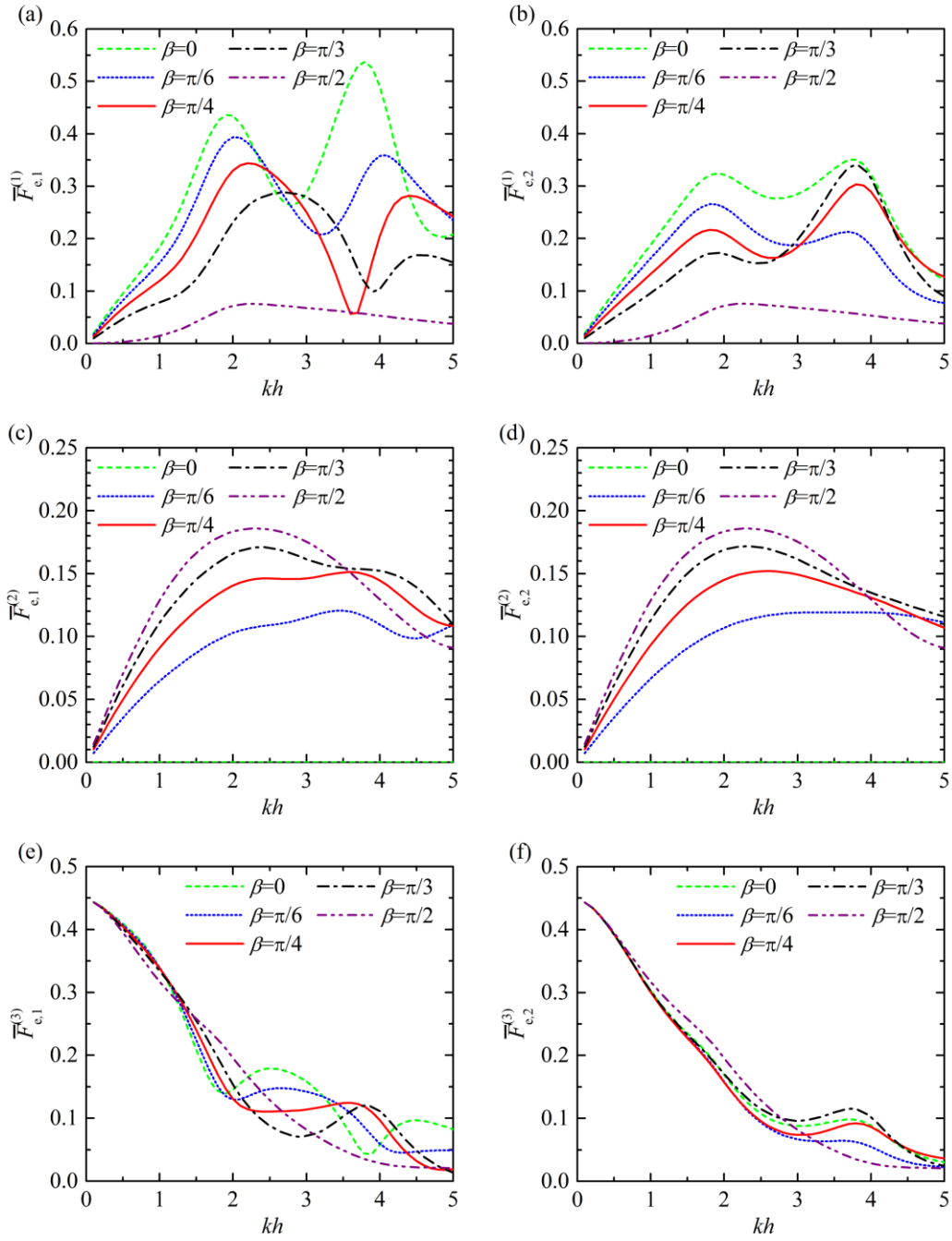

1
2
3
4
5

Fig. 6. Normalised wave excitation forces acting on the two caissons vs. kh for five incident wave angles: $\beta=0, \pi/6, \pi/4, \pi/3$ and $\pi/2$ with $e/h=1.0$: (a) $\bar{F}_{e,1}^{(1)}$; (b) $\bar{F}_{e,2}^{(1)}$; (c) $\bar{F}_{e,1}^{(2)}$; (d) $\bar{F}_{e,2}^{(2)}$; (e) $\bar{F}_{e,1}^{(3)}$; (f) $\bar{F}_{e,2}^{(3)}$.

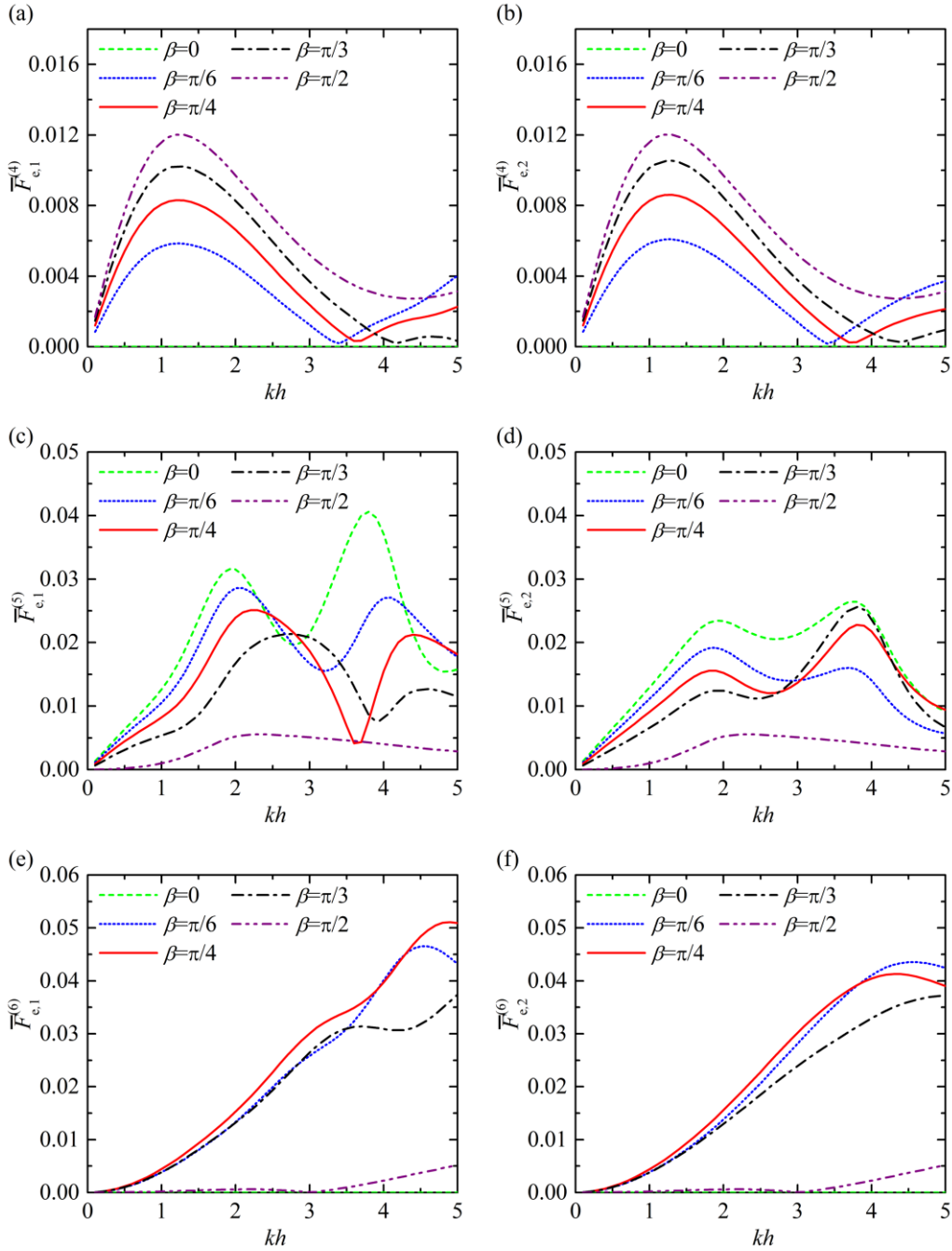

1

2

Fig. 7. Normalised wave excitation moments acting on the two caissons vs kh for five incident
 wave angles $\beta=0, \pi/6, \pi/4, \pi/3$ and $\pi/2$ with $e/h=1.0$: (a) $\bar{F}_{e,1}^{(4)}$; (b) $\bar{F}_{e,2}^{(4)}$; (c) $\bar{F}_{e,1}^{(5)}$; (d) $\bar{F}_{e,2}^{(5)}$; (e)
 $\bar{F}_{e,1}^{(6)}$; (f) $\bar{F}_{e,2}^{(6)}$.

4

5 6.2 Effect of spacing between caissons

6

To study the influence of the spacing between the caissons, e , we consider the same two
 caissons deployed with four different spacings, i.e., $e/h=0.5, 1.0, 1.5$ and 2.0 , suffering from
 incoming waves with $\beta=\pi/6$ are studied. In addition, as a comparison, wave diffraction from an
 individual caisson isolated in open sea is also analytically solved by using the method of [25]. The
 isolated caisson case is equivalent to the two-caisson case with an extremely large spacing
 between them, i.e., $e/h=\infty$, that the hydrodynamic interaction is vanishing. For such case,
 $\bar{F}_{e,1}^{(i)} = \bar{F}_{e,2}^{(i)}$, $i=1,2,\dots,6$.

12

1 Figures 8 and 9 illustrate the results of excitation forces and moments acting on the caissons,
 2 respectively. As shown in Fig. 8a, when the two caissons are placed far away from each other, i.e.,
 3 the isolated caisson case, the $\bar{F}_{e,1}^{(1)}$ ($\bar{F}_{e,2}^{(1)}$)- kh is a one peak curve. While when they are arranged
 4 close to each other, e.g., $e/h=0.5\sim 2.0$, affected by the reflected waves from Caisson 2, frequency
 5 response of the surge excitation force acting on Caisson 1, i.e., $\bar{F}_{e,1}^{(1)}$, is found to oscillate around
 6 the $\bar{F}_{e,1}^{(1)}$ - kh curve of isolated caisson case. It means that for different wave conditions, $\bar{F}_{e,1}^{(1)}$ can
 7 be either strengthened or weakened by the hydrodynamic interaction between the caissons. As e/h
 8 turns larger, strengthening and weakening effects of the hydrodynamic interaction on $\bar{F}_{e,1}^{(1)}$ can
 9 switch for a smaller change of kh . Different from $\bar{F}_{e,1}^{(1)}$, thanks to the sheltering effect of Caisson
 10 1, $\bar{F}_{e,2}^{(1)}$ is found weakened by hydrodynamic interaction for most wave conditions within $kh <$
 11 5.0 (Fig. 8b). For $3.0 < kh < 5.0$, $\bar{F}_{e,2}^{(1)}$ with $e/h=0.5$ is obviously smaller than the other cases.

12 As kh increases from 0 to 2.5, $\bar{F}_{e,1}^{(2)}$ increases from 0 to 0.11 and there is nearly no influence of
 13 e on $\bar{F}_{e,1}^{(2)}$ for these wave frequencies (Fig. 8c). As kh keeps increasing from 2.5 toward 5.0,
 14 $\bar{F}_{e,1}^{(2)}$ for the isolated caisson case stays at a flat level of $\bar{F}_{e,1}^{(2)}=1.1$. Whereas for the two caissons
 15 close to each other, fluctuations of the $\bar{F}_{e,1}^{(2)}$ - kh curve around that of the isolated caisson case are
 16 observed. The smaller the e/h , the stronger fluctuations occur. These fluctuations are not found for
 17 the sway excitation force acting on Caisson 2 (Fig. 8b). It should be noted that for $kh < 4.0$,
 18 although Caisson 2 is located at the lee side of Caisson 1, $\bar{F}_{e,2}^{(2)}$ is strengthened by the
 19 hydrodynamic interaction. The smaller the e/h , the larger $\bar{F}_{e,1}^{(2)}$ is obtained.

20 Similar to the effect of e on $\bar{F}_{e,1}^{(1)}$, the $\bar{F}_{e,1}^{(3)}$ - kh curves representing two-caisson cases are also
 21 observed to oscillate around the curve of isolated caisson case (Fig.8e). As e/h turns larger,
 22 strengthening and weakening effects of the hydrodynamic interaction on $\bar{F}_{e,1}^{(3)}$ switch more
 23 frequently for the same range of kh . It should be noted that generally the hydrodynamic interaction
 24 has opposite effects on $\bar{F}_{e,1}^{(1)}$ and $\bar{F}_{e,1}^{(3)}$, e.g., for the case with $e/h=1.5$ at $kh=3.0$, $\bar{F}_{e,1}^{(1)}$ is
 25 strengthened whereas $\bar{F}_{e,1}^{(3)}$ is weakened. The heave excitation force acting on Caisson 2, i.e.,
 26 $\bar{F}_{e,2}^{(3)}$ (Fig. 8f) is affected by e in a similar way as $\bar{F}_{e,2}^{(1)}$ is influenced (Fig. 8b).

27 Both $\bar{F}_{e,1}^{(4)}$ and $\bar{F}_{e,2}^{(4)}$ vanish around $kh=3.4$, regardless of the value of e/h (Figs.9a and 9b).
 28 For $kh < 3.4$, $\bar{F}_{e,1}^{(4)}$ is not affected by e , neither. Influence of e on $\bar{F}_{e,1}^{(4)}$ mainly happens at $4.0 <$
 29 $kh < 5.0$, where $\bar{F}_{e,1}^{(4)}$ in the case with $e/h=0.5$ is larger than those for the other cases. The results
 30 as given in Fig.9b show that $\bar{F}_{e,2}^{(4)}$ is approximately not influenced by e unless e is rather small,
 31 e.g., $e/h=0.5$, for which a slightly larger $\bar{F}_{e,2}^{(4)}$ is obtained for $kh < 3.4$, whereas an obvious
 32 smaller $\bar{F}_{e,2}^{(4)}$ is obtained for $kh > 3.5$.

33 Effect of e on $\bar{F}_{e,1}^{(5)}$ and $\bar{F}_{e,2}^{(5)}$ (Figs.9c and 9d) is rather similar to that on $\bar{F}_{e,1}^{(1)}$ and $\bar{F}_{e,2}^{(1)}$
 34 (Figs. 8a and 8b). Hence the description is not repeated here. The yaw moments acting on each
 35 caisson, especially those on Caisson 1, are found sensitive to e for $kh > 2.5$ (Figs.9e and 9f).
 36

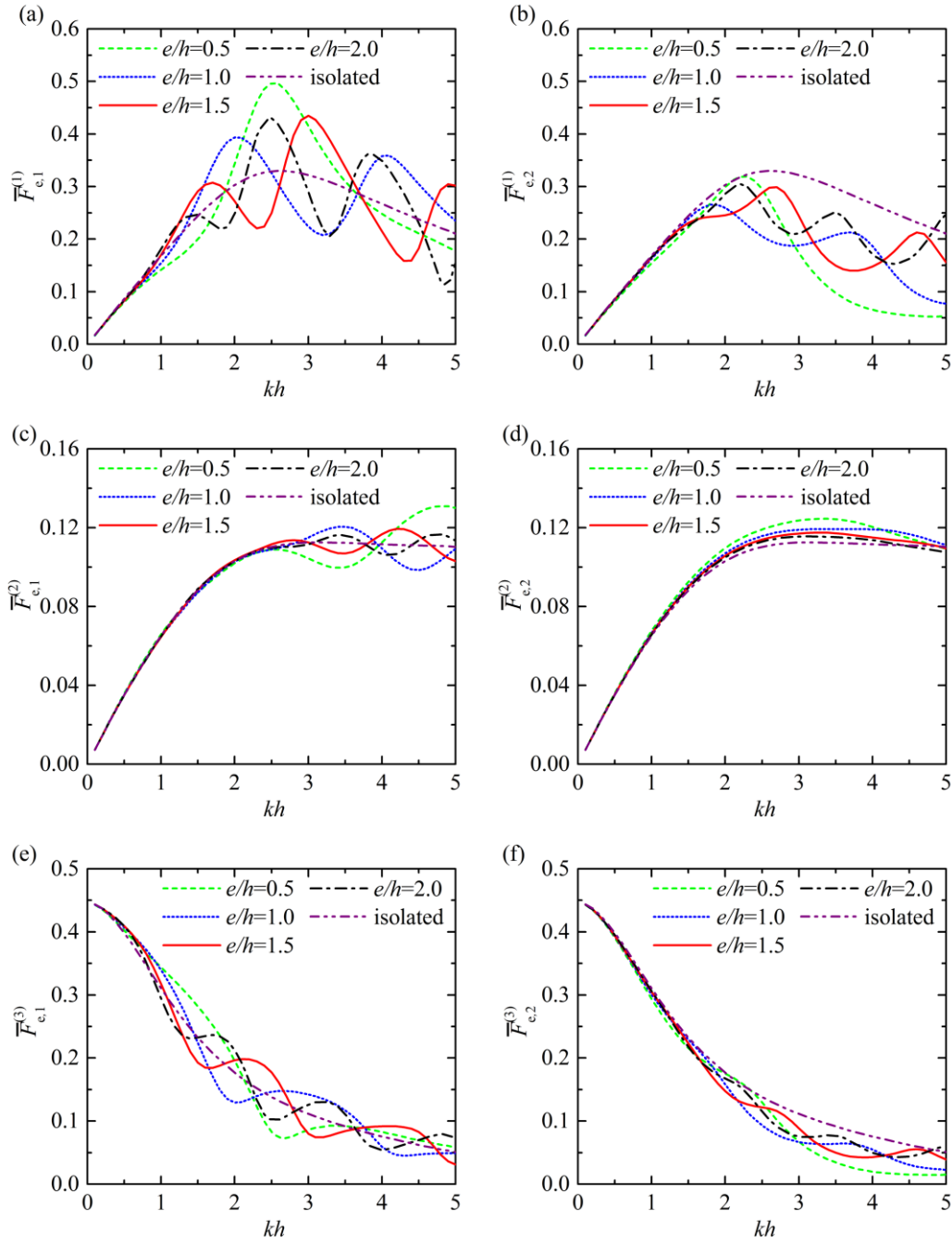

1
2
3
4
5

Fig. 8. Normalised wave excitation forces acting on the two caissons vs kh for four spacing $e/h=0.5, 1.0, 1.5$ and 2.0 , together with the isolated case with $\beta=\pi/6$: (a) $\bar{F}_{e,1}^{(1)}$; (b) $\bar{F}_{e,2}^{(1)}$; (c) $\bar{F}_{e,1}^{(2)}$; (d) $\bar{F}_{e,2}^{(2)}$; (e) $\bar{F}_{e,1}^{(3)}$; (f) $\bar{F}_{e,2}^{(3)}$.

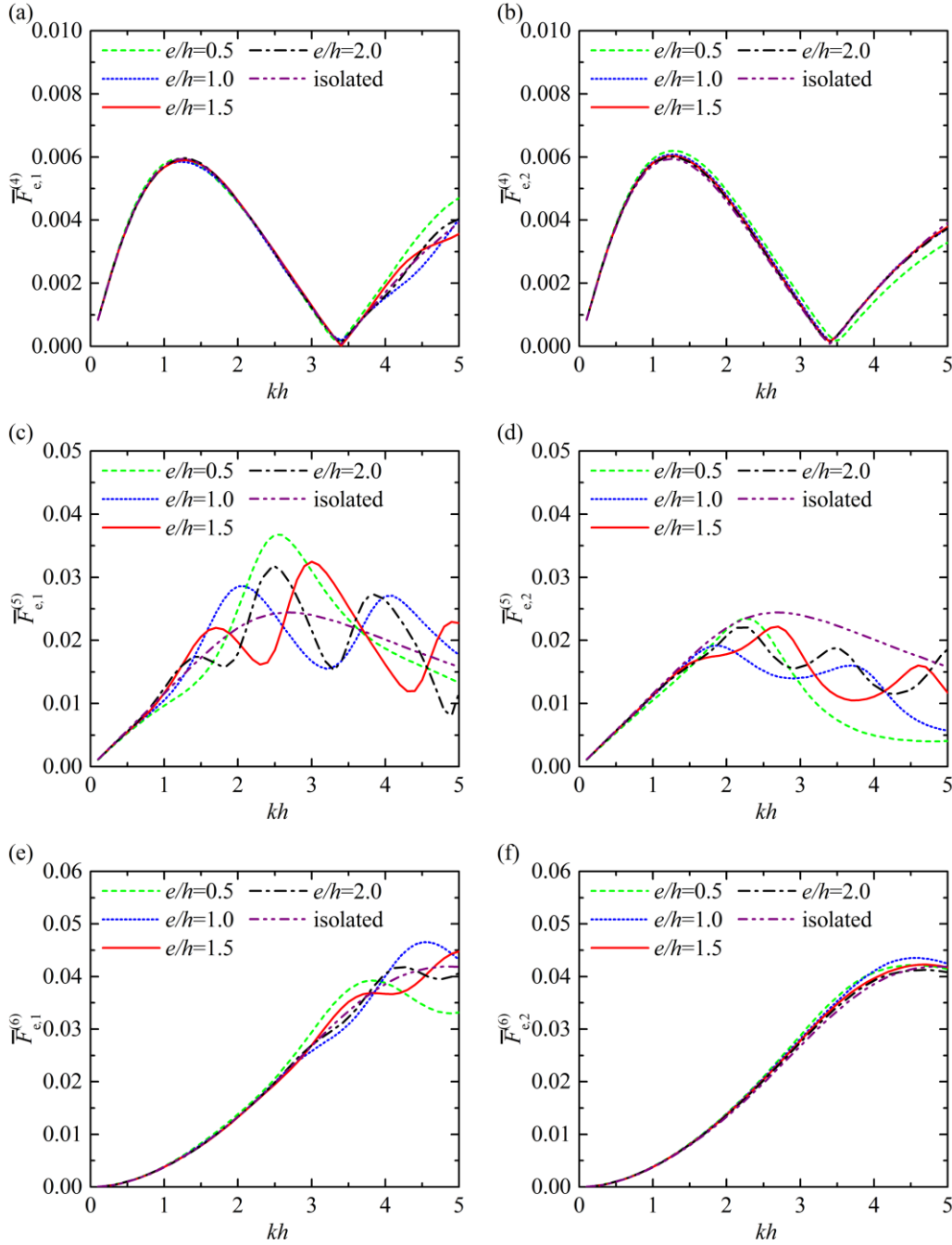

Fig. 9. Normalised wave excitation moments acting on the two caissons vs. kh for four spacings, $e/h=0.5, 1.0, 1.5$ and 2.0 , together with the isolated case with $\beta=\pi/6$: (a) $\bar{F}_{e,1}^{(4)}$; (b) $\bar{F}_{e,2}^{(4)}$; (c) $\bar{F}_{e,1}^{(5)}$; (d) $\bar{F}_{e,2}^{(5)}$; (e) $\bar{F}_{e,1}^{(6)}$; (f) $\bar{F}_{e,2}^{(6)}$.

6.3 Effect of layout

In practice, different configurations of the caissons, e.g., side by side and staggered, will be encountered during the transport and installation process. In this subsection, the layout with the two caissons in parallel at the same distance from their centers is considered. As shown in Fig. 10, the only variable parameter in the different configurations is the angle of the line connecting the caisson centers with the x -axis, which is defined as the configuration angle α .

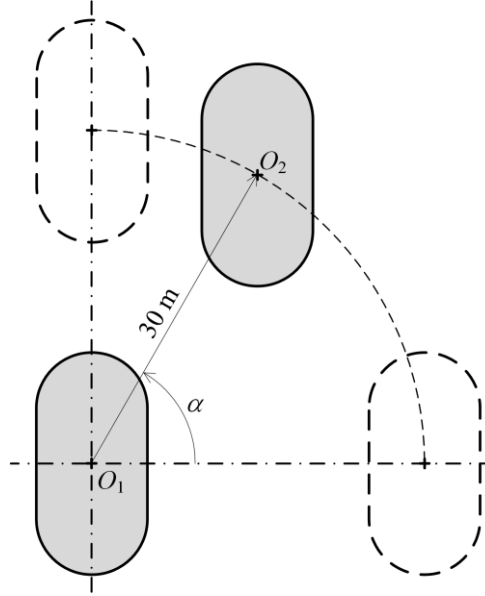

Fig. 10. Definition of the configuration angle α .

The two caissons with $\alpha = 0, \pi/6, \pi/4, \pi/3$ and $\pi/2$ subjected to incident waves with $\beta = \pi/6$ are analytically studied. Figures 11 and 12 present the comparison of the results of wave excitation forces and moments, respectively.

As α increases from 0 to $\pi/2$, the $\bar{F}_{e,1}^{(1)}$ - kh curve changes from double-peaked curve into single-peaked one (Fig.11a). With the increase of α , $\bar{F}_{e,1}^{(1)}$ at $kh = 2.0$ and 4.1 turn smaller and smaller, whereas $\bar{F}_{e,1}^{(1)}$ at $kh = 3$ gets larger and larger, revealing that opposite effects of α on $\bar{F}_{e,1}^{(1)}$ might happen for different wave conditions. While for all the wave conditions examined, except few wave frequencies around $kh = 4.0$, a larger α generally results in a larger $\bar{F}_{e,2}^{(1)}$ (Fig.11b).

In the five cases with α increasing from 0 to $\pi/2$, the value of $\bar{F}_{e,1}^{(2)}$ could change a lot for some specified wave conditions (Fig.11c). Take $kh = 2.6$ as an example, $\bar{F}_{e,1}^{(2)}$ for $\alpha = \pi/4$ is only 0.082, whereas for $\alpha = \pi/2$, $\bar{F}_{e,1}^{(2)}$ reaches 0.154, which is approximately two times as large as that when $\alpha = \pi/4$. Similar significant difference of $\bar{F}_{e,2}^{(2)}$ induced by variation of α can be observed for most wave conditions within $2.0 < kh < 5.0$ (Fig.11d). Among the five cases with different values of α , the cases with $\alpha = \pi/2$ and $\pi/3$ give the maximum and minimum values of $\bar{F}_{e,2}^{(2)}$, respectively, for most wave conditions. For kh ranging from 3.0 to 5.0, the maximum value of $\bar{F}_{e,2}^{(2)}$ is always two times as large as that of the minimum approximately.

For $1.2 < kh < 2.1$, $\bar{F}_{e,1}^{(3)}$ with $\alpha = \pi/2$ is the largest among the result in the five cases (Fig.11e). While for $2.4 < kh < 3.5$, on the contrary, $\bar{F}_{e,1}^{(3)}$ with $\alpha = \pi/2$ turns to be the smallest one. As a comparison, $\bar{F}_{e,2}^{(3)}$ is maximized and minimized when $\alpha = \pi/2$ and $\alpha = 0$, respectively, for any wave conditions at $1.9 < kh < 5.0$ (Fig.11f).

For $1.0 < kh < 1.7$, $\bar{F}_{e,1}^{(4)}$ with $\alpha = \pi/2$ is much smaller than any of the other four cases, whereas for $kh > 2.2$, $\bar{F}_{e,1}^{(4)}$ of such case turns to be the largest one (Fig.12a). Whatever the value of α is, a minimum value of $\bar{F}_{e,1}^{(4)}$ occurs around $kh = 3.3$. While the kh corresponding to the minimum value of $\bar{F}_{e,2}^{(4)}$ is a bit more sensitive to the variation of α , e.g., the kh corresponding to the minimum of $\bar{F}_{e,2}^{(4)}$ for $\alpha = \pi/3$ and $\pi/2$ are 3.0 and 3.6, respectively. For kh ranging from 1.3 to 3.1, $\bar{F}_{e,2}^{(4)}$ for the cases with $\alpha = \pi/3$ and $\pi/2$ are always the smallest and largest ones, respectively, among the five cases.

The frequency response curves of $\bar{F}_{e,1}^{(5)}$ and $\bar{F}_{e,2}^{(5)}$ for different α (Figs. 12c and 12d) are

1 found to be similar to those of $\bar{F}_{e,1}^{(1)}$ and $\bar{F}_{e,2}^{(1)}$ in Figs. 11a and 11b. The discussion of the effect
 2 of α on $\bar{F}_{e,1}^{(1)}$ and $\bar{F}_{e,2}^{(1)}$ can be applied to $\bar{F}_{e,1}^{(5)}$ and $\bar{F}_{e,2}^{(5)}$ as well.

3 Figures 12e and 12f illustrate the results of $\bar{F}_{e,1}^{(6)}$ and $\bar{F}_{e,2}^{(6)}$. For $kh > 2.5$, compared with the
 4 other four cases, $\bar{F}_{e,2}^{(6)}$ with $\alpha=0$ is much larger and deserves more attention for stability.

5

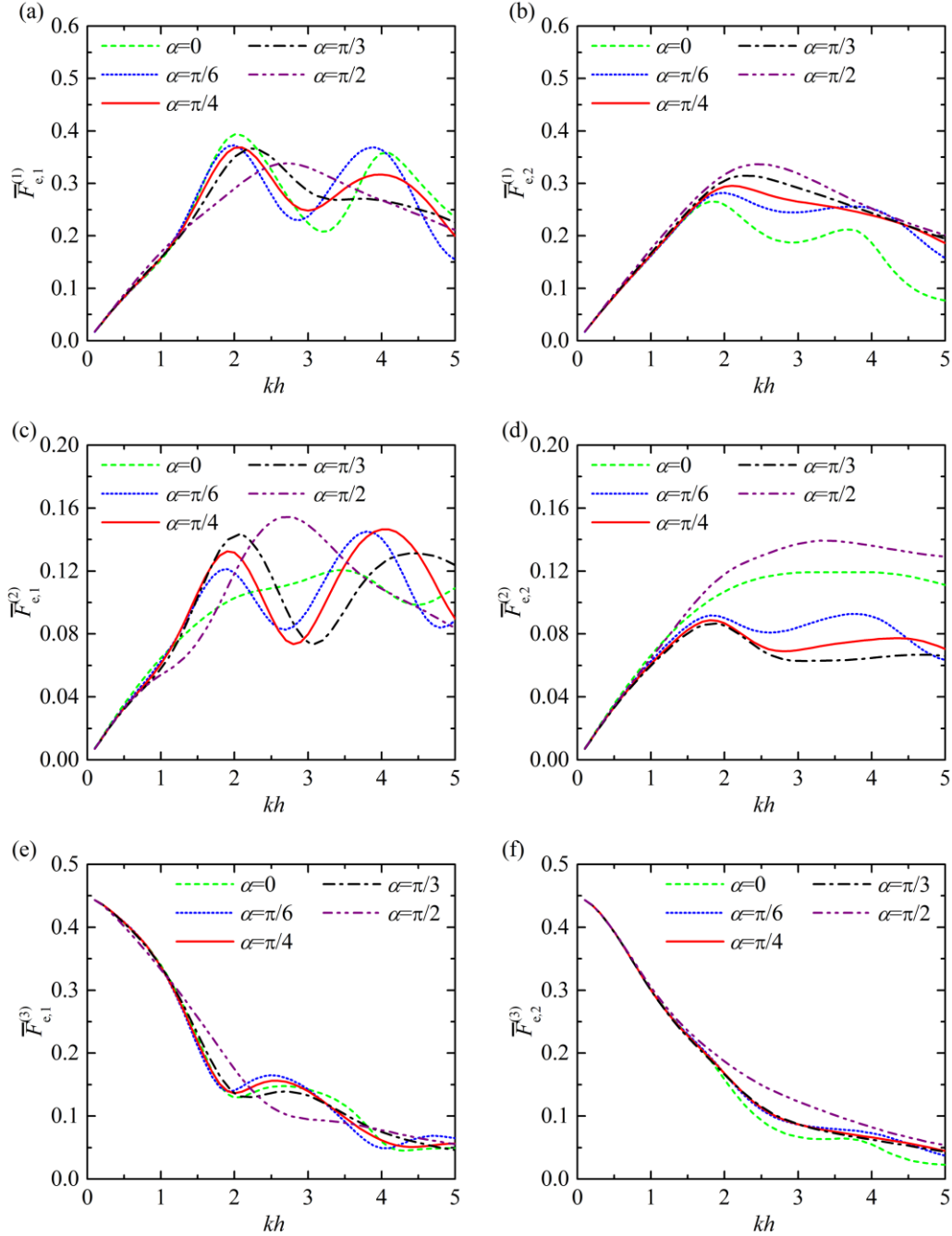

6

7 Fig. 11. Normalised wave excitation forces acting on the two caissons vs kh for different
 8 configuration angle $\alpha = 0, \pi/6, \pi/4, \pi/3$ and $\pi/2$ with $\beta = \pi/6$: (a) $\bar{F}_{e,1}^{(1)}$; (b) $\bar{F}_{e,2}^{(1)}$; (c) $\bar{F}_{e,1}^{(2)}$; (d)
 9 $\bar{F}_{e,2}^{(2)}$; (e) $\bar{F}_{e,1}^{(3)}$; (f) $\bar{F}_{e,2}^{(3)}$.

10

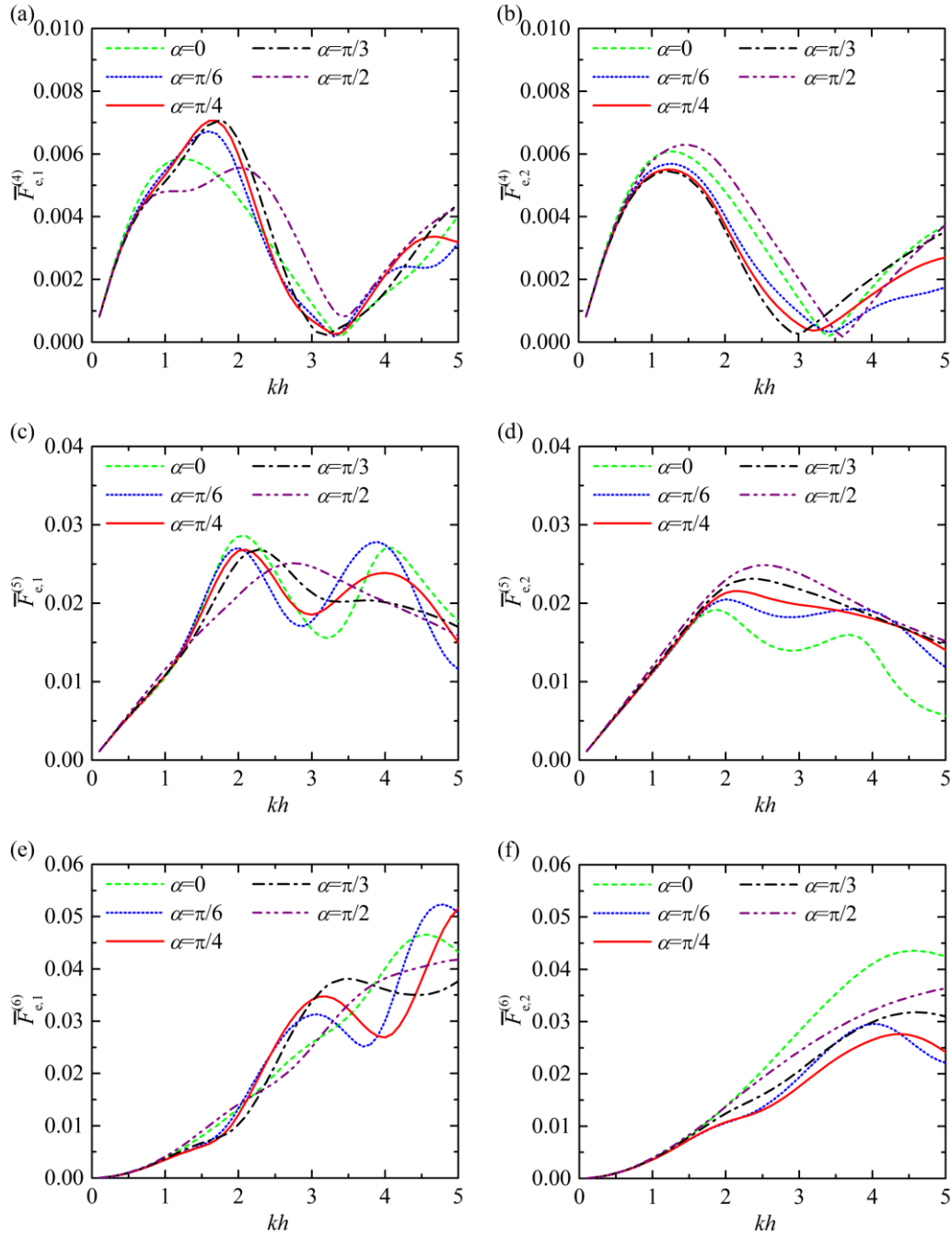

1

2

Fig. 12. Normalised wave excitation moments acting on the two caissons vs kh for different configuration angle $\alpha=0, \pi/6, \pi/4, \pi/3$ and $\pi/2$ with $\beta=\pi/6$: (a) $\bar{F}_{e,1}^{(4)}$; (b) $\bar{F}_{e,2}^{(4)}$; (c) $\bar{F}_{e,1}^{(5)}$; (d) $\bar{F}_{e,2}^{(5)}$; (e) $\bar{F}_{e,1}^{(6)}$; (f) $\bar{F}_{e,2}^{(6)}$.

4

5 6.4 Effect of the shape of cross section

6

7 To examine the effect of the shape of the cross section of the cylinders, we consider two
 8 identical caissons with a similar deployment to Fig. 2, and with the same horizontal distance
 9 between the centroids of 30 m, but with different cross sections. More specifically, four cross
 10 sections are examined (Fig. 13a; only one caisson is plotted), in which κ and κ' represent the ratios
 11 of the lengths of the two straight edge sections relative to the corner radius, R_0 (Fig. 13b). All
 these cross sections have the same area. Note κ' is set to zero unless otherwise specified. As κ

1 increases from 0, the cross section evolves from circular into quasi-elliptical with its major axis in
 2 parallel with the y -axis. The larger the κ , the slenderer the shape. The exact size of the cross
 3 section for the case $\kappa=2$ can be found in Fig. 2. For $\kappa=\kappa'=2$, the cross section turns into a square
 4 with circular corners. The caisson draft of all these four cases $d_n=5$ m, water depth $h=20$ m, and
 5 incident wave direction $\beta=\pi/6$.

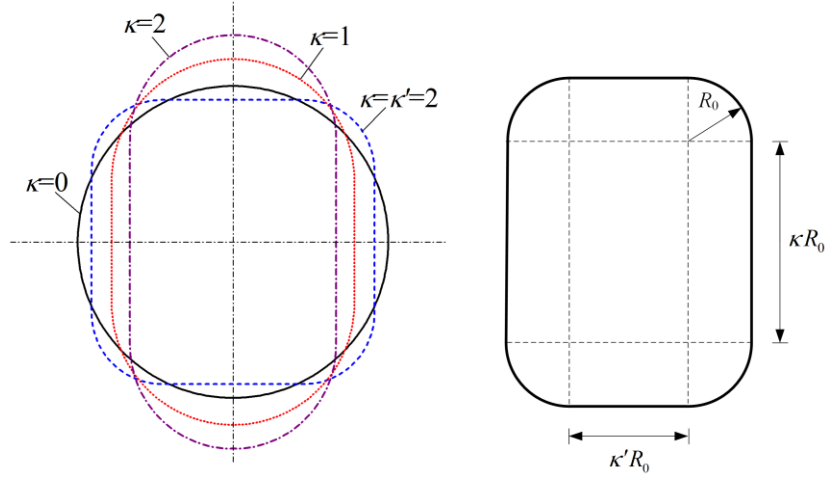

6

7 Fig. 13. (left) Schematic of the four shapes of cross section; (right) Definition of κ and κ' .

8

9 Figure 14 shows the variation with kh of the excitation forces acting on each caisson in surge,
 10 sway and heave modes for different shapes of cross section. Results of the excitation moments
 11 acting on each caisson in roll, pitch and yaw modes are given in Fig. 15.

12 Since the caissons in the case $\kappa=2$ are the slenderest among the four cases, the wave
 13 excitation forces/moments acting on each caisson in this case in surge, pitch and yaw modes are
 14 the largest among the case studies for the majority of the wave frequencies tested, and the wave
 15 excitation forces in the sway mode are the smallest. Similar curves representing the surge and
 16 heave wave excitation forces, together with the pitch excitation moment acting on each caisson for
 17 cases $\kappa=0$ and $\kappa=\kappa'=2$ are observed (Figs. 14a, 14b, 14e, 14f, 15c and 15d). Although the length of
 18 the caissons in the case $\kappa=\kappa'=2$ along the x -axis is smaller than the case $\kappa=0$, $\bar{F}_{e,1}^{(2)}$ and $\bar{F}_{e,2}^{(2)}$ for
 19 case $\kappa=\kappa'=2$ are the largest for all the wave frequencies tested (Figs. 14 c and 14d). In long waves,
 20 e.g., $kh < 2.0$, the wave excitation forces acting on each caisson in heave mode are nearly
 21 independent of the shape of the cross sections with the same area (Figs. 14e and 14f). For
 22 $2.0 < kh < 3.8$ a larger $\bar{F}_{e,1}^{(3)}$ can be obtained for the case with a larger κ and $\kappa'=0$.

23 As shown in Figs. 15a and 15b, $\bar{F}_{e,1}^{(4)}$ and $\bar{F}_{e,2}^{(4)}$ for cases $\kappa=1$ and 2 vanish for certain wave
 24 conditions. As a comparison, $\bar{F}_{e,1}^{(4)}$ and $\bar{F}_{e,2}^{(4)}$ for cases $\kappa=0$ and $\kappa=\kappa'=2$ never vanish for the
 25 entire range of wave frequencies tested. Moreover, $\bar{F}_{e,1}^{(4)}$ and $\bar{F}_{e,2}^{(4)}$ for case $\kappa=\kappa'=2$ are larger
 26 compared to case $\kappa=0$ for the whole range of computed wave conditions. As expected, the yaw
 27 excitation moments vanish for circular caissons, i.e., case $\kappa=0$ (Fig. 15e and 15f).

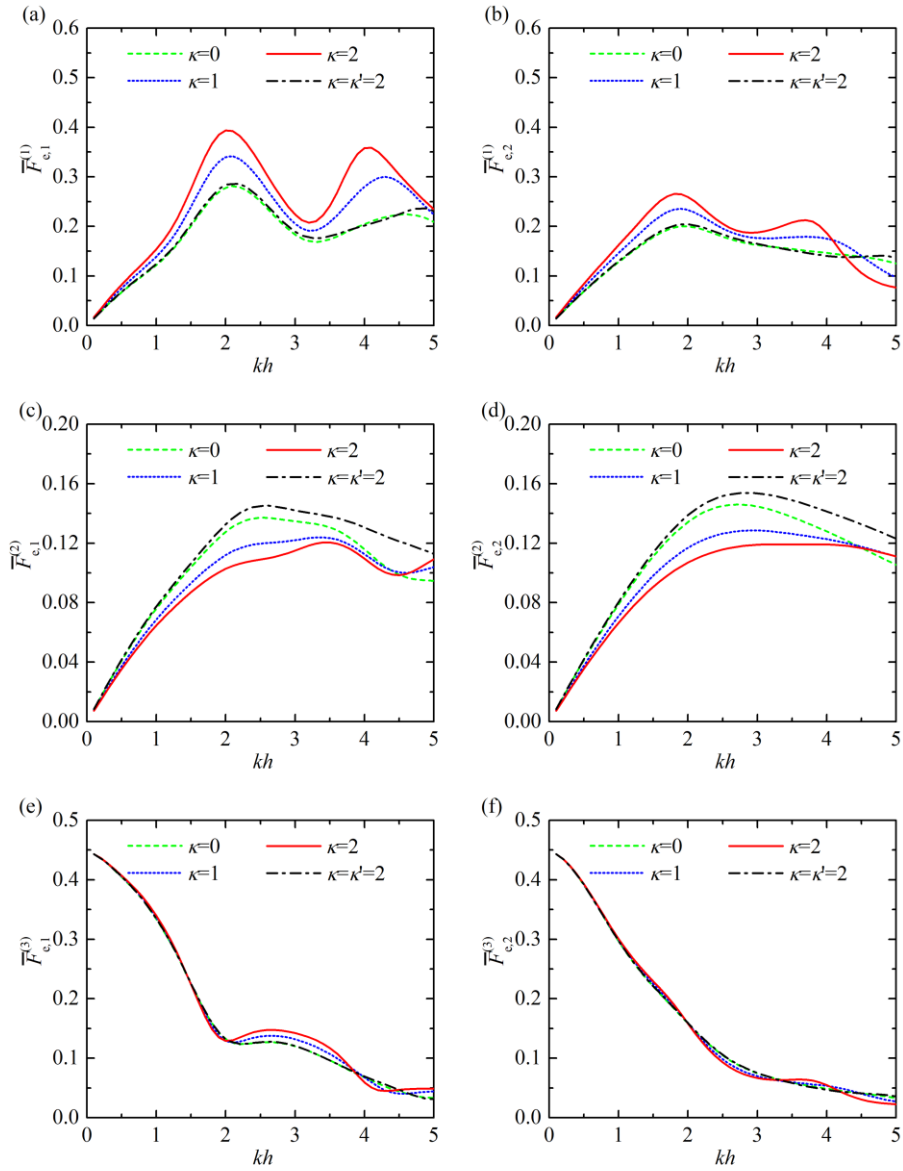

1

2

Fig. 14. Normalised wave excitation forces acting on the two caissons vs. kh for four shapes of

3

cross section: (a) $\bar{F}_{e,1}^{(1)}$; (b) $\bar{F}_{e,2}^{(1)}$; (c) $\bar{F}_{e,1}^{(2)}$; (d) $\bar{F}_{e,2}^{(2)}$; (e) $\bar{F}_{e,1}^{(3)}$; (f) $\bar{F}_{e,2}^{(3)}$.

4

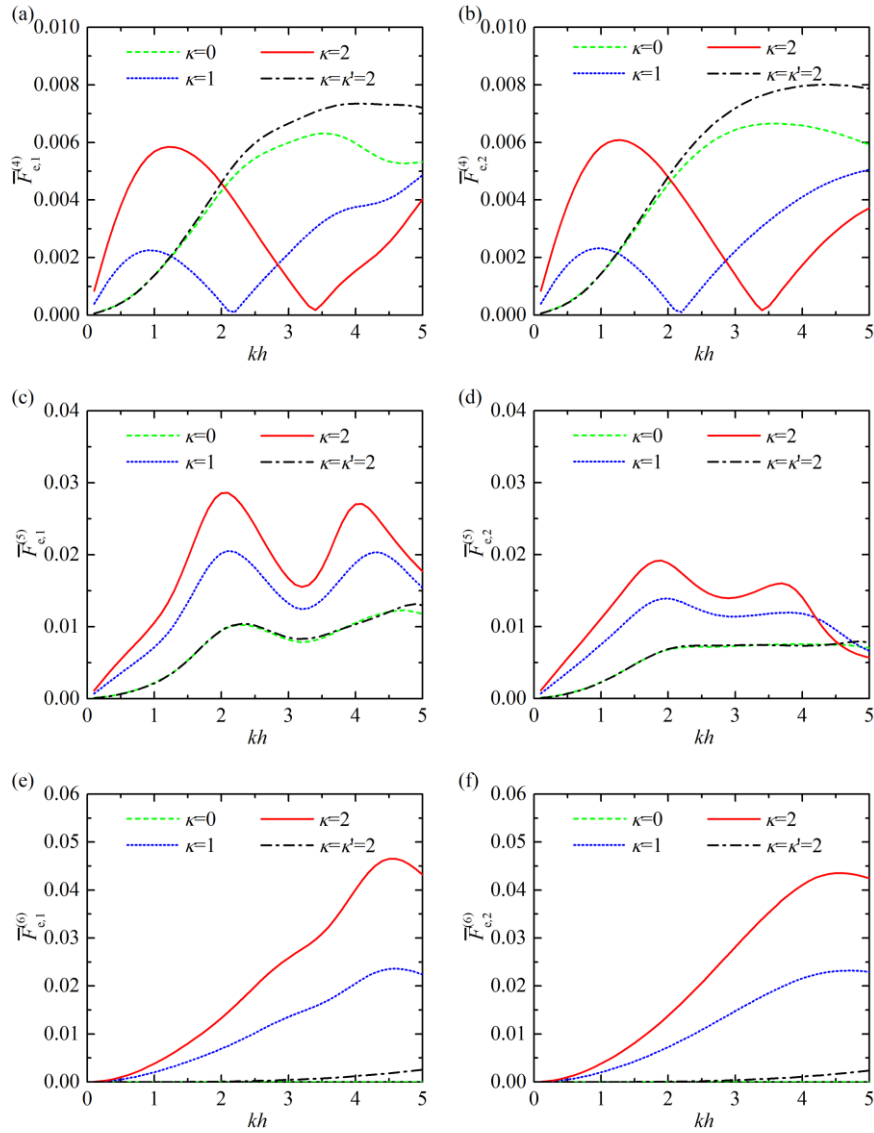

1

2 Fig. 15. Normalised wave excitation forces acting on the two caissons vs. kh for four shapes of
 3 cross section: (a) $\bar{F}_{e,1}^{(4)}$; (b) $\bar{F}_{e,2}^{(4)}$; (c) $\bar{F}_{e,1}^{(5)}$; (d) $\bar{F}_{e,2}^{(5)}$; (e) $\bar{F}_{e,1}^{(6)}$; (f) $\bar{F}_{e,2}^{(6)}$.

4 7 Conclusions

5 In this paper we developed an analytic model for the problem of wave diffraction from
 6 multiple truncated cylinders with arbitrary cross sections. Assuming the cylinders are subjected to
 7 regular waves of small steepness, linear potential flow theory is applied in the analytic model. The
 8 whole water domain is divided into interior regions below each cylinder and an exterior region
 9 representing the rest of the water domain. On this basis, the diffracted spatial velocity potential in
 10 these regions can be written as series of eigen-functions. The Fourier series method combined
 11 with the eigen-function expansion matching method are then used to satisfy the wetted surface
 12 body conditions and continuity conditions between adjacent regions, and to determine the
 13 unknown coefficients of the expressions of the diffracted spatial potential. Excellent agreement is
 14 found between the analytic results of wave excitations forces and moments and the numerical
 15 results obtained from a BEM-based code and the published data as well, which validates the
 16 analytic model. The model is then applied to study wave diffraction from two caissons and to

1 explore the effect of the incident wave angle, spacing between two caissons and configuration
 2 angle on the wave excitation forces and moments. Wave diffraction from the two identical
 3 caissons with some other shapes of cross section are also examined. The following conclusions
 4 may be drawn.

5 For two parallel caissons with the same dimensions located in a row, when incident waves
 6 propagate along the channel between them, i.e., $\beta = \pi/2$, the surge excitation force, pitch and yaw
 7 excitation moments acting on each caisson are triggered by the hydrodynamic interaction between
 8 the caissons. For different wave frequencies, changing the incident wave angle might play
 9 opposite roles, i.e., strengthening and weakening roles, on $\bar{F}_{e,1}^{(3)}$. For $kh < 3.8$, the yaw excitation
 10 moments on both caissons for $\beta = \pi/4$ are larger than in the other cases (with different values of β).

11 Frequency responses of the surge, sway and heave excitation forces and also the pitch and
 12 yaw moments acting on Caisson 1 are found to oscillate around the $\bar{F}_{e,1}^{(i)} - kh$ curve of isolated
 13 caisson case. This can be explained by the strengthening and weakening effects of the
 14 hydrodynamic interaction. As the spacing between the caissons increases, strengthening and
 15 weakening effects alternate at smaller intervals of kh .

16 As α increases from 0 to $\pi/2$ with $\beta = \pi/6$, the $\bar{F}_{e,1}^{(1)} - kh$ and $\bar{F}_{e,1}^{(5)} - kh$ curves change from
 17 double-peaked curves into single-peaked ones. With the increase of α , opposite effects of α on
 18 $\bar{F}_{e,1}^{(1)}$ and $\bar{F}_{e,1}^{(5)}$ might happen for different wave conditions. For most wave conditions, the cases
 19 with $\alpha = \pi/2$ and $\pi/3$ give the maximum and minimum values of $\bar{F}_{e,2}^{(2)}$ among the cases with five
 20 different value of α , respectively. The maximum value of $\bar{F}_{e,2}^{(2)}$ can be twice as large as that of
 21 the minimum for $kh > 3.0$. Whatever the value of α is, a minimum value of $\bar{F}_{e,1}^{(4)}$ occurs around
 22 $kh = 3.3$. For kh ranging from 1.3 to 3.1, $\bar{F}_{e,2}^{(4)}$ is always the minimum and maximum for $\alpha = \pi/3$
 23 and $\pi/2$, respectively, among the five cases. For short waves, e.g., $kh > 2.5$, $\bar{F}_{e,2}^{(6)}$ with $\alpha = 0$ is
 24 much larger than in the other four cases, and it deserves more attention for stability.

25 The wave excitation forces/moments acting on each caisson in case $\kappa = 2$ in surge, pitch and
 26 yaw modes are the largest among the case studies for the majority of the wave frequencies tested,
 27 and the wave excitation forces in the sway mode are the smallest. $\bar{F}_{e,1}^{(2)}$ and $\bar{F}_{e,2}^{(2)}$ for case
 28 $\kappa = \kappa' = 2$ are the largest for the entire range of wave frequencies tested.

29 The research presented in this paper focused on wave diffraction from multiple stationary
 30 truncated cylinders. The analytic model established in this paper, together with that developed by
 31 Zheng, Zhang, Liu and Iglesias [41] for solving the problem of wave radiation from cylinders
 32 oscillating independently in the absence of an incident wave, can be used to calculate the
 33 hydrodynamic response of an array of truncated cylinders of arbitrary cross sections freely
 34 floating in water waves.

35 Acknowledgments

36 This research was supported by China Postdoctoral Science Foundation (Grant no. 2016M601041,
 37 2017T100085), National Natural Science Foundation of China (51679124, 51879144) and
 38 Intelligent Community Energy (ICE), INTERREG V FCE, European Commission (Contract no.
 39 5025).

40

References

- [1] M. Lamas-Pardo, G. Iglesias, L. Carral, A review of very large floating structures (VLFS) for coastal and offshore uses, *Ocean Eng*, 109 (2015) 677-690.
- [2] C.J.R. Garrett, Wave forces on a circular dock, *Journal of Fluid Mechanics*, 46 (1971) 129-139.
- [3] J.L. Black, C.C. Mei, M.C.G. Bray, Radiation and Scattering of Water Waves by Rigid Bodies, *Journal of Fluid Mechanics*, 46 (1971) 151-&.
- [4] X. Yu, A.T. Chwang, Analysis of wave scattering by submerged circular disk, *J Eng Mech-Asce*, 119 (1993) 1804-1817.
- [5] B. Teng, D.Z. Ning, Wave diffraction from a uniform cylinder in front of a vertical wall, *The Ocean Engineering*, 21 (2003) 48-52.
- [6] X. Yu, B. Zhang, An extended analytic solution for combined refraction and diffraction of long waves over circular shoals, *Ocean Eng*, 30 (2003) 1253-1267.
- [7] B. Wu, Y. Zheng, Y. You, X. Sun, Y. Chen, On scattering and radiation problem for a cylinder over a cylindrical barrier in water of finite depth, *Engineering Science*, 6 (2004) 48-55.
- [8] X.J. Niu, X.P. Yu, An analytic solution for combined wave diffraction and refraction around a vertical cylinder with idealized scour pit, *Coast Eng*, 67 (2012) 80-87.
- [9] W. Finnegan, M. Meere, J. Goggins, The wave excitation forces on a truncated vertical cylinder in water of infinite depth, *J Fluid Struct*, 40 (2013) 201-213.
- [10] D.Z. Ning, X.L. Zhao, B. Teng, L. Johanning, Wave diffraction from a truncated cylinder with an upper porous sidewall and an inner column, *Ocean Eng*, 130 (2017) 471-481.
- [11] S. Zheng, Y. Zhang, Wave diffraction from a truncated cylinder in front of a vertical wall, *Ocean Eng*, 104 (2015) 329-343.
- [12] S. Zheng, Y. Zhang, Wave radiation from a truncated cylinder in front of a vertical wall, *Ocean Eng*, 111 (2016) 602-614.
- [13] F. Arena, Note on a paper by Ogilvie: the interaction between waves and a submerged horizontal cylinder, *Journal of Fluid Mechanics*, 394 (1999) 355-356.
- [14] F. Arena, Interaction between long-crested random waves and a submerged horizontal cylinder, *Physics of Fluids*, 18 (2006).
- [15] D. Pavone, F. Arena, Forces of random wave groups on vertical cylinders, 25th International Conference on Offshore Mechanics and Arctic Engineering Hamburg, Germany, 2006, pp. 249-253.
- [16] H. Yu, S. Zheng, Y. Zhang, G. Iglesias, Wave radiation from a truncated cylinder of arbitrary cross section, *Ocean Eng*, 173 (2019) 519-530.
- [17] H.S. Chen, C.C. Mei, Scattering and radiation of gravity waves by an elliptical cylinder, Department of Civil Engineering, MIT, 1971.
- [18] A.N. Williams, Wave-forces on an elliptic cylinder, *Journal of Waterway, Port, Coastal, and Ocean Engineering*, 111 (1985) 433-449.
- [19] H.S. Chen, C.C. Mei, Wave forces on a stationary platform of elliptical shape, *Journal of Ship Research*, 17 (1973) 61-71.
- [20] A.N. Williams, Wave Diffraction by Elliptical Breakwaters in Shallow-Water, *Ocean Eng*, 12 (1985) 25-43.
- [21] A.N. Williams, M.K. Darwiche, Three-dimensional wave scattering by elliptical breakwaters, *Ocean Eng*, 15 (1988) 103-118.
- [22] S. Zhang, A.N. Williams, Wave scattering by submerged elliptical disk, *Journal of Waterway, Port,*

- Coastal, and Ocean Engineering, 122 (1996) 38-45.
- [23] A.M. Mansour, A.N. Williams, K.H. Wang, The diffraction of linear waves by a uniform vertical cylinder with cosine-type radial perturbations, *Ocean Eng*, 29 (2002) 239-259.
- [24] J. Liu, A. Guo, H. Li, Analytical solution for the linear wave diffraction by a uniform vertical cylinder with an arbitrary smooth cross-section, *Ocean Eng*, 126 (2016) 163-175.
- [25] J. Liu, A. Guo, Q. Fang, H. Li, H. Hu, P. Liu, Investigation of linear wave action around a truncated cylinder with non-circular cross section, *Journal of Marine Science and Technology*, 23 (2018) 866-876.
- [26] N.B. Dişibüyük, A.A. Korobkin, O. Yilmaz, Linear wave interaction with a vertical cylinder of arbitrary cross section: An asymptotic approach, *Journal of Waterway, Port, Coastal, and Ocean Engineering*, 143 (2017).
- [27] S. Zhu, G. Moule, An efficient numerical calculation of wave loads on an array of vertical cylinders, *Applied Mathematical Modelling*, 20 (1996) 26-33.
- [28] H. Kagemoto, D.K.P. Yue, Interactions among multiple three-dimensional bodies in water waves: an exact algebraic method, *Journal of Fluid Mechanics*, 166 (1986) 189-209.
- [29] S. Alliney, Water waves diffraction around cylindrical obstacles, *Applied Mathematical Modelling*, 5 (1981) 237-240.
- [30] O. Yilmaz, A. Incecik, Analytical solutions of the diffraction problem of a group of truncated vertical cylinders, *Ocean Eng*, 25 (1998) 385-394.
- [31] O. Yilmaz, Hydrodynamic interactions of waves with group of truncated vertical cylinders, *Journal of Waterway, Port, Coastal, and Ocean Engineering*, 124 (1998) 272-279.
- [32] P. Siddorn, R. Eatock Taylor, Diffraction and independent radiation by an array of floating cylinders, *Ocean Eng*, 35 (2008) 1289-1303.
- [33] C.M. Linton, D.V. Evans, The interaction of waves with arrays of vertical circular cylinders, *Journal of Fluid Mechanics*, 215 (1990) 549-569.
- [34] S. Zheng, Y. Zhang, Theoretical modelling of a new hybrid wave energy converter in regular waves, *Renew Energ*, 128A (2018) 125-141.
- [35] S. Zheng, Y. Zhang, G. Iglesias, Wave-structure interaction in hybrid wave farms, *J Fluid Struct*, 83 (2018) 386-412.
- [36] R. Eatock Taylor, On modelling the diffraction of water waves, *Ship Technology Research*, 54 (2007) 54-80.
- [37] I.K. Chatjigeorgiou, S.A. Mavrakos, An analytical approach for the solution of the hydrodynamic diffraction by arrays of elliptical cylinders, *Applied Ocean Research*, 32 (2010) 242-251.
- [38] I.K. Chatjigeorgiou, Three dimensional wave scattering by arrays of elliptical and circular cylinders, *Ocean Eng*, 38 (2011) 1480-1494.
- [39] I.K. Chatjigeorgiou, The hydrodynamics of arrays of truncated elliptical cylinders, *European Journal of Mechanics B/Fluids*, 37 (2013) 153-164.
- [40] J.T. Chen, J.W. Lee, A semi-analytical method for near-trapped mode and fictitious frequencies of multiple scattering by an array of elliptical cylinders in water waves, *Physics of Fluids*, 25 (2013) 097103.
- [41] S. Zheng, Y. Zhang, Y. Liu, G. Iglesias, Wave radiation from multiple cylinders of arbitrary cross sections, *Ocean Eng*, 184 (2019) 11-22.
- [42] M. Abramowitz, I.A. Stegun, *Handbook of mathematical functions*, Government Printing Office, Washington, D.C., 1964.
- [43] M.E. Eidem, Overview of floating bridge projects in Norway, *Proceedings of the ASME 2017*

36th International Conference on Ocean, Offshore and Arctic Engineering Trondheim, Norway, 2017.

[44] ANSYS-AQWA, Release. Vol. 14., ANSYS-Inc. Pennsylvania, USA, 2011.