

2018-12-01

A constrained A* approach towards optimal path planning for an unmanned surface vehicle in a maritime environment containing dynamic obstacles and ocean currents

Singh, Y

<http://hdl.handle.net/10026.1/12372>

10.1016/j.oceaneng.2018.09.016

Ocean Engineering

Elsevier

All content in PEARL is protected by copyright law. Author manuscripts are made available in accordance with publisher policies. Please cite only the published version using the details provided on the item record or document. In the absence of an open licence (e.g. Creative Commons), permissions for further reuse of content should be sought from the publisher or author.

The following is the author-generated post-print of an article that appeared as

Y. Singh, S. Sharma, R. Sutton, D.[C.] Hatton, and A. Khan. A constrained A* approach towards optimal path planning for an unmanned surface vehicle in a maritime environment containing dynamic obstacles and ocean currents. *Ocean. Eng.*, 2018.

doi:[10.1016/j.oceaneng.2018.09.016](https://doi.org/10.1016/j.oceaneng.2018.09.016).

The article is copyright © 2018 Elsevier Ltd.. As permitted by the standard Elsevier copyright transfer agreement (the version for authors complying with the UK HEFCE Open Access policy), this copy is distributed (from 15th November 2019 onwards) under the [Creative Commons CC BY-NC-ND licence](https://creativecommons.org/licenses/by-nc-nd/4.0/).

A constrained A* approach towards optimal path planning for an unmanned surface vehicle in a maritime environment containing dynamic obstacles and ocean currents

Yogang Singh^{a,*}, Sanjay Sharma^a, Robert Sutton^a, Daniel Hatton^a, Asiya Khan^a

^a*Autonomous Marine Systems (AMS) Research Group, University of Plymouth, Plymouth, PL4 8AA, United Kingdom*

Abstract

Efficient path planning is a critical issue for the navigation of modern unmanned surface vehicles (USVs) characterized by a complex operating environment having dynamic obstacles with a spatially variable ocean current. The current work explores an A* approach with an USV enclosed by a circular boundary as a safety distance constraint on generation of optimal waypoints to resolve the problem of motion planning for an USV moving in a maritime environment. Unlike existing work on USV navigation using graph based methods, this study extends the implementation of the proposed A* approach in an environment cluttered with static and moving obstacles and different current intensities. The study also examines the effect of headwind and tailwind currents moving in clockwise and anti clockwise direction respectively of different intensities on optimal waypoints in a partially dynamic environment. The performance of the proposed approach is verified in simulations for different environmental conditions. The effectiveness of the proposed approach is measured using two parameters, namely, path length and computational time as considered in other research works. The results show that the proposed approach is effective for global path planning of USVs.

Keywords: A star, Marine environment, Ocean currents, Path planning, Unmanned surface vehicle

1. Introduction

Recent advances in electronic navigation and intelligent robots have become an imperative aid to navigate marine vehicles effectively for applications ranging from reconnaissance in hostile areas to operations in dangerous weather conditions (Loe, 2008). Although the technology of unmanned surface vehicles(USVs) dates back to World War II, major research

*Corresponding author at : School of Engineering, University of Plymouth, PL4 8AA, Plymouth, United Kingdom

Email address: yogang.singh@plymouth.ac.uk (Yogang Singh)

towards development of USVs technology and improving their autonomy started after the successful implementation of USVs in the 1990-1991 Gulf war (Campbell and Naeem, 2012).

Path planning is an important layer in the mission management system of an USV voyage. In accordance with the current level of autonomy, USVs needs an effective and safe path planning approach in a cluttered operating environment. A substantial amount of research has been conducted in the area of path planning of unmanned surface vehicles. Path planning for USVs can be classified into two categories, namely, reactive approaches (Khatib, 1986, Borenstein and Koren, 1991, Mohanty and Parhi, 2013, Fiorini and Shiller, 1998) where vehicles makes decision *en route* and deliberative approaches where vehicles follows a predetermined path (Hart et al., 1968, Holland, 1992, Kennedy, 2011). Several computational approaches comprising of evolutionary methods such as Genetic Algorithm (GAs) or Particle Swarm Optimisation (PSO) (Zeng et al., 2015, Aghababa, 2012), graph search techniques (Garau et al., 2005, Singh et al., 2017a), artificial potential field (APF) (Warren, 1990, Singh et al., 2017b) and fast marching (FM) (Liu et al., 2017, Petres et al., 2007) have been applied in path planning of marine vehicles.

Ocean environmental effects and moving obstacles play the most significant role in path planning of USVs and very few literatures have covered their effect on path planning in the last decade (Tam et al., 2009, Statheros et al., 2008).Neglecting environmental effects in path planning not only leads to significant wastage of energy in USVs while navigating in strong currents but could also elevate the potential danger of impact with the obstacles (moving or static) in an ocean environment. In order to save energy, avoid the collision and to increase the endurance of USVs enabled with limited computational resources, it is important to plan the USVs voyage in advance before the mission commences by considering environmental effects and dynamic obstacles in path planning of USVs. Traditionally, grid search techniques have been found most efficient in generating path in fastest computation time compared to other reactive approaches adopted in path planning of robots (Mohanty and Parhi, 2013).

The paper is organized as follows : In the current section, the literature pertaining to path planning of USV has been described with major contributions of the current study being explained. In section 2, a detailed overview of the methodology adopted in the current study is presented. In the subsequent section, simulation studies conducted in various environmental scenarios are reported and the proposed approach is benchmarked. The conclusions of the current study are reported in the final section.

1.1. Related work

Many studies have been conducted on the subject of grid based path planning in the area of marine vehicles from different perspectives of collision avoidance, heading constraint, environmental disturbances and energy consumption. By reviewing the literature on the subject of optimal path planning in marine vehicles, most of these studies have been in the area of autonomous underwater vehicles (AUVs) (Alvarez et al., 2004, Garau et al., 2005, Kruger et al., 2007, Zeng et al., 2016, Soullignac, 2011, Kumar et al., 2005)and very fewer studies have been in the area of path planning of USVs. AUVs cannot operate in all environmental conditions due to limited speed and onboard capabilities against USVs

which are more suited for operation in areas of high military, shipping or fishing activity, due to acoustic interference, collision risk, and net entanglement. AUVs are also less well suited to tidally dominated shallow-water settings that have high levels of anthropogenic infrastructure and activity. This leads to requirement of development of dedicated path planning approaches for USVs against path planning approaches adopted for AUVs.

The grid based path planning was first proposed in form of the Dijkstra algorithm (Dijkstra, 1959) which was later extended to the A* algorithm by introducing an heuristic cost (Hart et al., 1972) to speed up the search process by pruning the search space. Generally in grid based path planning, the objective is to find the shortest path by avoiding static obstacles (Stentz, 1994). This approach was first introduced into USV path planning, where an improved three layered architecture towards USV path planning in a harbour was proposed by combining a reactive and A* approach (Casalino et al., 2009). In another work, a A* approach was extended by combining a grid based path planner with a locally bounded optimal planner towards USV path planning in uncertain sea environment (Svec et al., 2011). The International Maritime Organization (IMO) ((IMO, 1988, 1995, 2007)) has suggested certain regulations for navigation in a marine environment for collision avoidance commonly known as International Regulations for Preventing Collisions at Sea(COLREGs). A COLREGs based A* approach was proposed for way point navigation of an USV complying with Rule 14 of COLREGs in an environment cluttered with static and moving obstacles (Naeem et al., 2012). A modified A* approach, Finite Angle A*(FAA*) towards obtaining shorter path length than classic A* approach has been adopted in a study conducted on USV path planning in an environment comprising static obstacles with a constraint of keeping safe distance from obstacles (Yang et al., 2012).

Currently a substantial amount of research in mobile robotics towards modifying the conventional A* algorithm to improve its performance as per the mission and kinematic requirement of the robot i.e. A* with Post Smoothing (Rabin, 2000), Field D* (David and Anthony, 2005), Theta* (Nash et al., 2007) and D* Lite (Koenig and Likhachev, 2002) has been conducted. Owing to technical similarities between mobile robots and USVs, some of the improved approaches have been extended in path planning of USVs. USVs are generally constrained by yaw rate and heading angle in real time manoeuvring. A modified A* algorithm, Theta*, for search in 3D Euclidean space at all orientation was implemented for USV path planning complying with heading angle of USV and compared with conventional grid based 3D path planners (Kim et al., 2012). In a further work, the Theta* algorithm was improved in terms of computational time and path length against conventional 3D path planners for USV path planning in form of ARC-Theta* algorithm (Kim et al., 2014), which considers angular rate (yaw rate) of USV in path planning. Another improvement in the A* algorithm for USV path planning was proposed by a modifying heuristic for ocean environment with surface currents constrained to heading angle and diverse water depth (Lee et al., 2015). Another novel work in area of optimal path planning of USVs has been conducted recently by using FM² algorithm, an optimal approach to FM method by considering environmental disturbances (Garrido and Moreno, 2016).

1.2. Problem definition and major contribution

In the present context of autonomy required in the marine environment, autonomous navigation of USVs in a practical marine environment needs to be cognizable of three important issues, namely, safety, reliability of the mission and likelihood of the success (Statheros et al., 2008, LaValle, 2006). Central to the path planning algorithms, two approaches are widely adopted namely, a waypoint approach and a trajectory based approach. Way point approach is associated with non parameterized straight line paths generated from connection of waypoints while trajectory based approach is associated with time parameterized path to convert the waypoint paths into dynamic trajectories (Şerban, 2016). The present study adopts a way-point approach over trajectory based approach for a USV named, *Springer*, shown in Fig.1, navigating in a practical marine environment due to its easier implementation in practical scenarios (Fossen, 1995). The specifications of *Springer*, available at Plymouth University, are tabulated in Table 1. USVs operate in an environment where ocean environmental effects and moving ships have a significant effect on the way-point selection for an USV voyage based on mission requirement. These mission requirements can be classified in small-scale and large-scale operations. Small-scale operations include bathymetric surveys, pollution monitoring and data assimilation in a cluttered environment where the generation of safer way-points have the highest priority in the path planning while large-scale operations include trans-oceanic voyage and cooperative surveying where the shortest distance is required for high endurance. Hence there is a challenge to conserve energy as well as consider safety of USVs in USV path planning for USVs designed with heterogeneous mission requirements in mind.



Figure 1: The *Springer* USV

Ocean environmental effects can be bifurcated into three streams, as the additive and multiplicative disturbances on vehicle hull, namely, wind, waves and ocean currents (Fossen,

Parameters	Values
Length (m)	4.2
Width (m)	2.3
Displacement (tonnes)	0.6
Maximum speed (m/s)	4

Table 1: Specifications of *Springer*

1995). Wind load is generally ignored in path planning since USVs have a high draft compared to an air projection area and operations are generally restricted in an environment with wind speed less than 10 m/s (Lee et al., 2015). In order to simulate the motion of USVs, it is generally assumed that wave loads account for fluctuating pressure distribution below the water surface and water surface remains unaffected (Fossen, 1995). Hence wave loads become more significant in dynamic positioning than path planning. Wind generated currents have the highest significance on path planning and way-point generation. Since the Earth is rotating, the Coriolis force turns major currents to the right in the northern hemisphere while opposite in southern hemisphere (Fossen, 1995) as viewed from above. Consequently, another major challenge is to understand the steady non uniform headwind and tailwind (Knight, 2008, Belcher, 2007) currents effect on way-point generation and optimality in grid-based path planners. This challenge becomes more complex when uncertain obstacles in form of moving obstacles appear in the operational domain of an USV.

The work of (Kim et al., 2014) has showed that conventional A* outperforms other heuristic variants of A* in terms of computational time and Euclidean distance in a maritime environment. Henceforth, leading to requirement of developing a computationally effective version of A* by adopting the conventional A* approach. In order to address aforementioned challenges and issues pertaining to the autonomy of USVs, the current study adopts an A* approach with an USV enclosed by a circular boundary as a safety distance constraint on generation of optimal waypoints. . This resolves the problem of optimal path planning for an USV moving in a practical maritime environment, leading to generation of safer way-points with conservation of energy. Fig.2 describes a comparison of the path generated by conventional grid-based method against the path generated by conventional grid-based method considering safety distance and surface ocean currents. To the best of the authors knowledge, such an approach has not been adopted and studied towards USV path planning in a cluttered environment having static and moving obstacles in addition to surface currents. USVs are mostly equipped with limited computational resources in addition to limited endurance. This paper assess the effectiveness of the proposed approach in terms of computational time to generate path and path length in simulation studies conducted in various environmental scenarios.

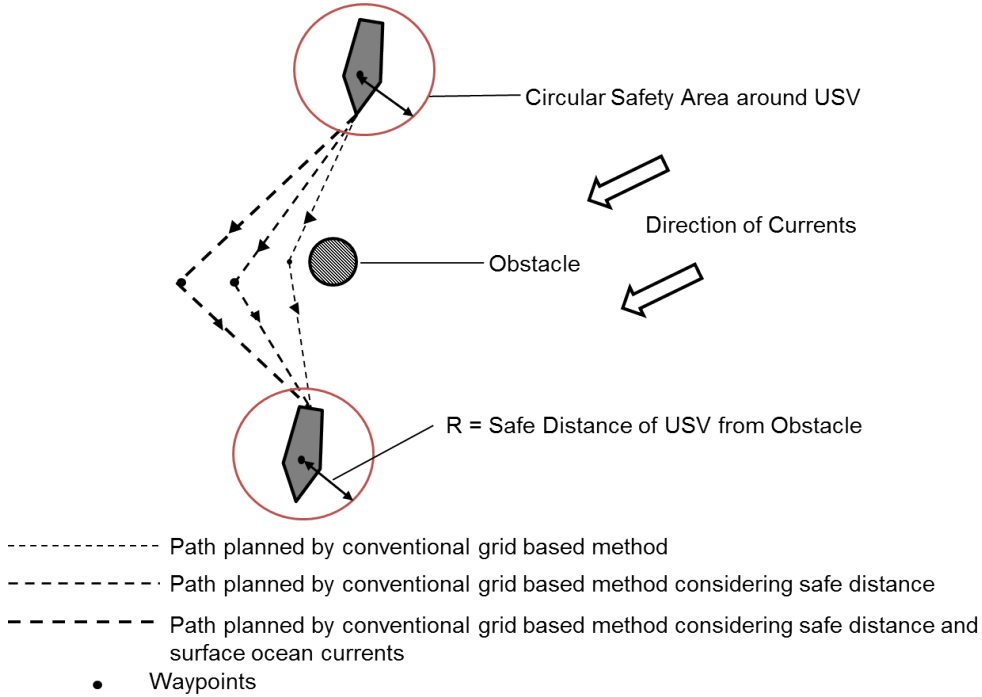

Figure 2: A schematic showing the path generated by a conventional grid based path planner compared against the path generated by a grid based path planner by considering safety distance and sea surface currents (clockwise). In case of anti clockwise currents, the sea surface currents push the USV towards the obstacle and the proposed algorithm makes sure that a safety distance is maintained to ensure no collision

2. Methodology Overview

2.1. Environmental mapping

The abstraction of path planning for USVs is shown in Fig.3. In order to implement path planning algorithms, mapping the environment becomes the initial step. Environmental mapping converts world space into Configuration space (Cspace) which helps in quick implementation of algorithms and manageable storage in computers (Mooney et al., 2010). The Cspace for USVs are dynamic in nature with high spatial and temporal variability. This paper adopts a popular mapping technique, namely, regular occupancy grid due to its effective resolution in grid based path planners (Mooney et al., 2010). Portsmouth harbour is among the busiest harbours in United Kingdom and is a perfect area for understanding path planning of USVs. In this study, binary images of satellite images of Portsmouth harbour taken from *Google Maps* have been utilized as gridded maps for the proposed A* approach as shown in Fig.4. The Cspace for the planar USV is considered as R^2 , representing the planar positions of the USV where an USV is treated as a pixel point on the map. The map of the environment is the converted binary image where free space is considered as 1 (white) while obstacle is considered as 0 (black). The 800×800 binary image has a resolution of 3.6 m per pixel length.

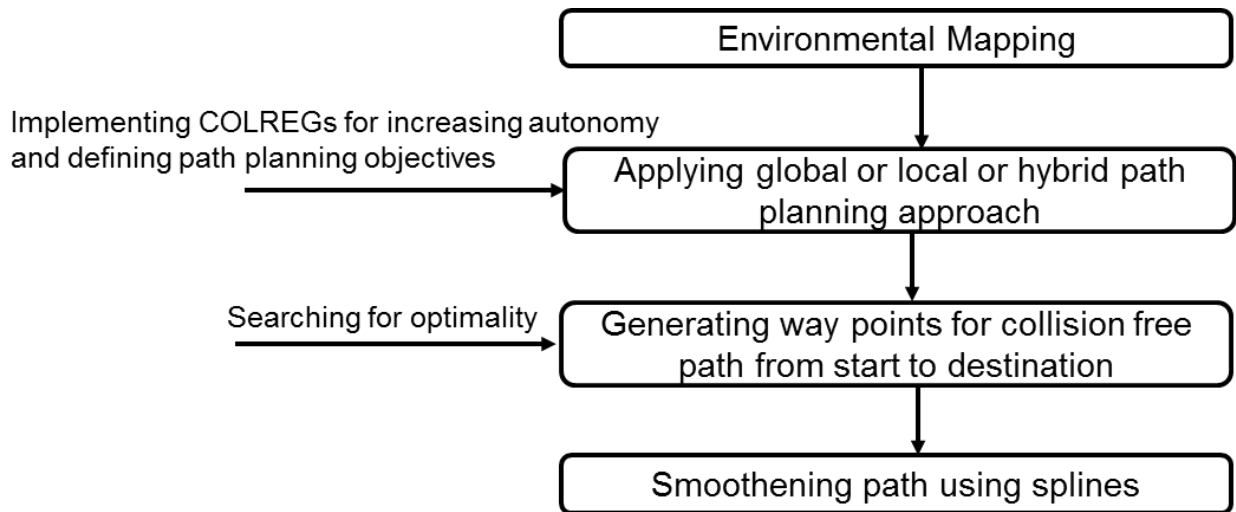

Figure 3: Path planning abstraction for USVs (Singh et al., 2016)

2.2. A* Algorithm

The choice of approach is the next step in path planning of USVs. In the present study, the A* approach with safety distance constraints has been adopted. Adoption of certain path planning approaches in an USV is mission dependent. Since the current study considers an USV, *Springer*, developed with primary purpose of monitoring sea pollution, generation of safer way points with conservation of optimality for higher endurance becomes the highest priority. Although several approaches have been adopted in the literature (Sec. 1.1), no approach has been able to compute path with a better computational time than the conventional A* approach in simulation studies.

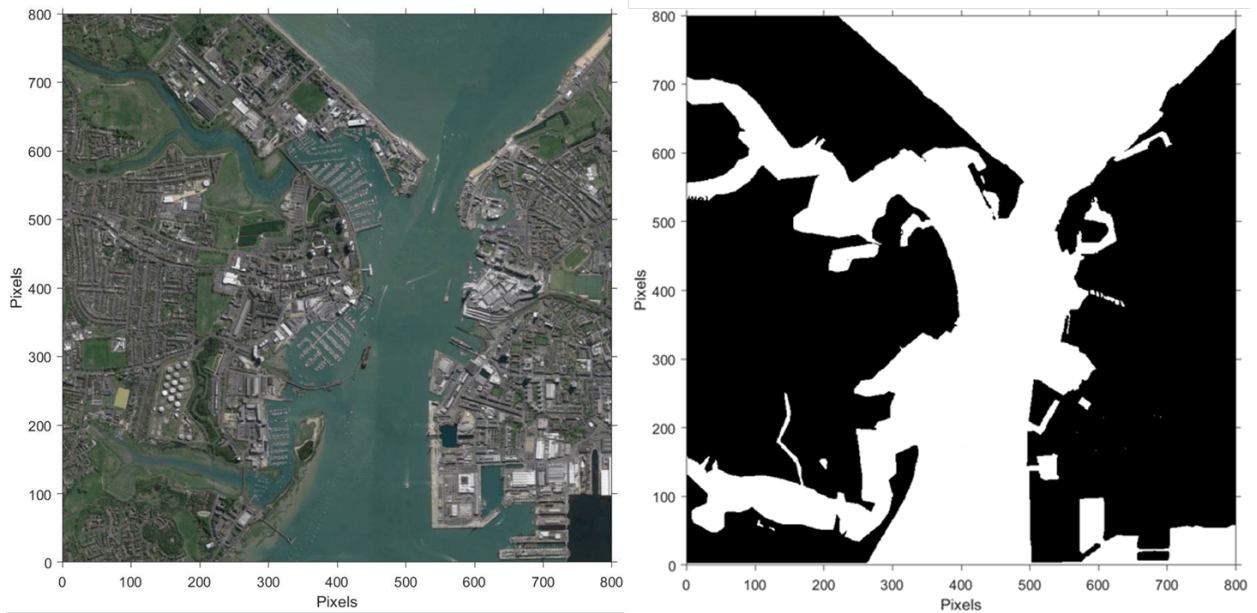

Figure 4: Satellite image of Portsmouth Harbour and its corresponding binary image (Source: *Google Maps*)

The A* algorithm on a gridded map is restricted either to 4-connectivity or 8-connectivity, as shown in Fig.5, based on resolution required, where each cell in Cspace is evaluated by the value:

$$f(n) = h(n) + g(n) \quad (1)$$

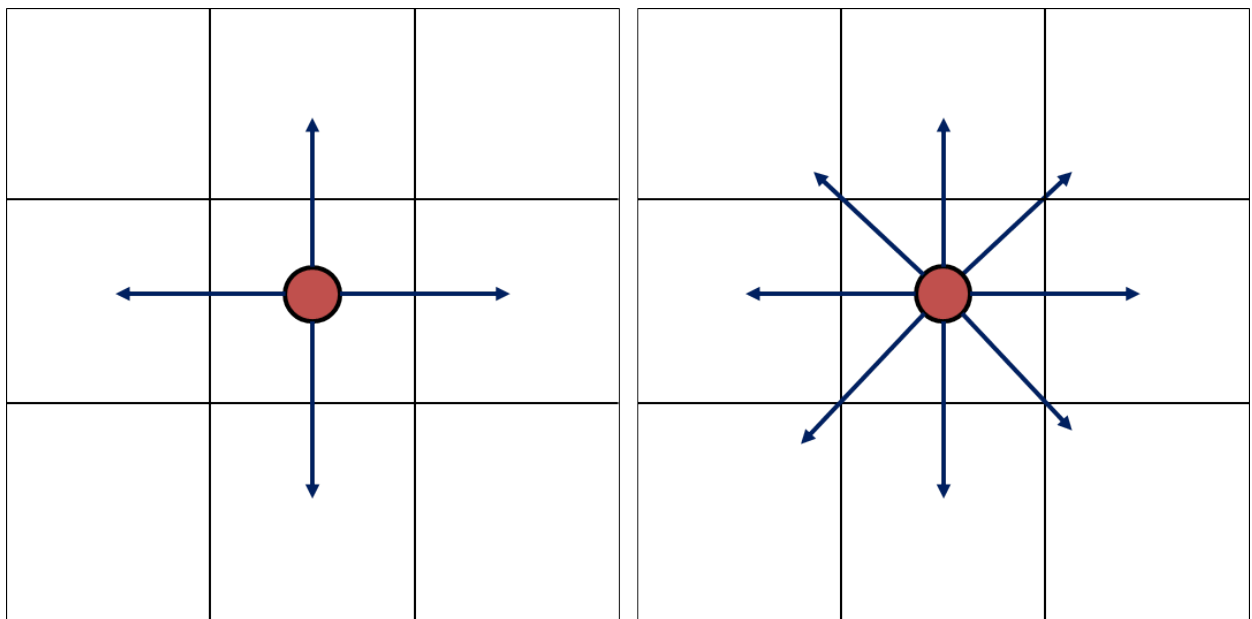

Figure 5: Schematic of 4-connectivity and 8-connectivity in Cspace

where, $h(n)$ is the heuristic distance of the cell to the goal state and $g(n)$ is the length of the path from initial state to goal state through selected sequence of cells. Each adjacent cell of actually reached cell is evaluated by value of $f(n)$ and the one with lowest value of $f(n)$ is chosen as the next one in sequence. This advantage of modifying distance in A* gives wide range of modifications which can be applied in the algorithm in form of energy consumption and safety distance (Duchoň et al., 2014). The present study considers the safety distance constraint to study the path planning of USVs.

2.3. Assumptions

The complexity of USV path planning is massive and a number of simplifications have been recommended to reduce the intricacies of the problem (Azariadis and Aspragathos, 2005). Here, the following assumptions have been made:

1. The map (study area) is considered to be in a confined sea environment near to Portsmouth harbor. Henceforth, temporal and spatial variability in the chosen study area in terms of environmental effects and moving vessels is considered quasi-static for the period of the USV voyage.
2. Kalman filter and other sensor measurements are used on a USV to determine the obstacle position over time. The current study assumes that position and velocity of the moving obstacle in Cspace is known from a Kalman filter.
3. The given moving obstacles are modelled as ellipse on the grid map by combining two grid points, where each grid point comprises of a semi ellipse, since it is a standard practice in a marine environment to consider moving obstacles in an elliptical domain as per the recommendations of the IMO (Tam et al., 2009). Overlapping of elliptical shape with grid cell boundary is neglected.
4. The USV is modelled as a particle under the assumption that an effective, robust controller quickly establishes the commanded velocity.
5. The USVs are generally having a combination of deliberative and reactive systems on board for planning path in a marine environment. The deliberative systems help in determining global waypoints while reactive systems are responsible for collision avoidance when dynamic obstacles come in the USV safety domain described in Fig. 2. It is assumed that such reactive collision avoidance takes over in off-nominal conditions, such as a case where a previously undetected obstacle appears or global path planner fails to generate a path.

An schematic of the path planning system adopted in the current study is shown in Fig. 8. Information of sea surface current, moving obstacles and topography of the study area is used to define the map in the form of a graph and the proposed approach is used to generate safer waypoints for an optimal path.

2.4. Challenges of incorporating COLREGs in path planning algorithms

The COLREGs serves as a handbook for selecting avoidance manoeuvres. It is a requirement suggested by IMO for all vessels moving in oceans to ensure operational safety.

Recently, several efforts have been made to integrate COLREGs in path planning algorithms for USVs (Svec et al., 2013, Kuwata et al., 2014). However, these studies work safely in a scenario with very few complexities with an assumption that each vessel in the operational domain has the same amount of information about the current COLREGs situation and reacts in same way. This hypothesis does not hold true in real time where each sailor interprets COLREGs based on speed, size and heading of the other vessel (Shah, 2016). In addition to that, various external factors such as limited field of view, ocean currents and seamanship in case of breaching the COLREGs make it non-trivial to incorporate COLREGs rules into path planning framework used in complex scenarios.

The present state of the approaches in COLREGs are local in nature and the present study assumes that reactive planner on the USV work satisfactorily in close encounter scenarios. Hence, the proposed approach in the present study do not consider incorporating COLREGs in path planning of USV and makes an effort to plan path in a computationally efficient manner so that local planners have enough time to respond to dynamically changing situations.

2.5. Incorporating Guidance and Control System with Path Planning Algorithm

The general architecture of an USV operation in a maritime environment has basically three subsystems, namely, control and path planning, obstacle detection and avoidance (ODA) and communication and monitoring as shown in Fig.6

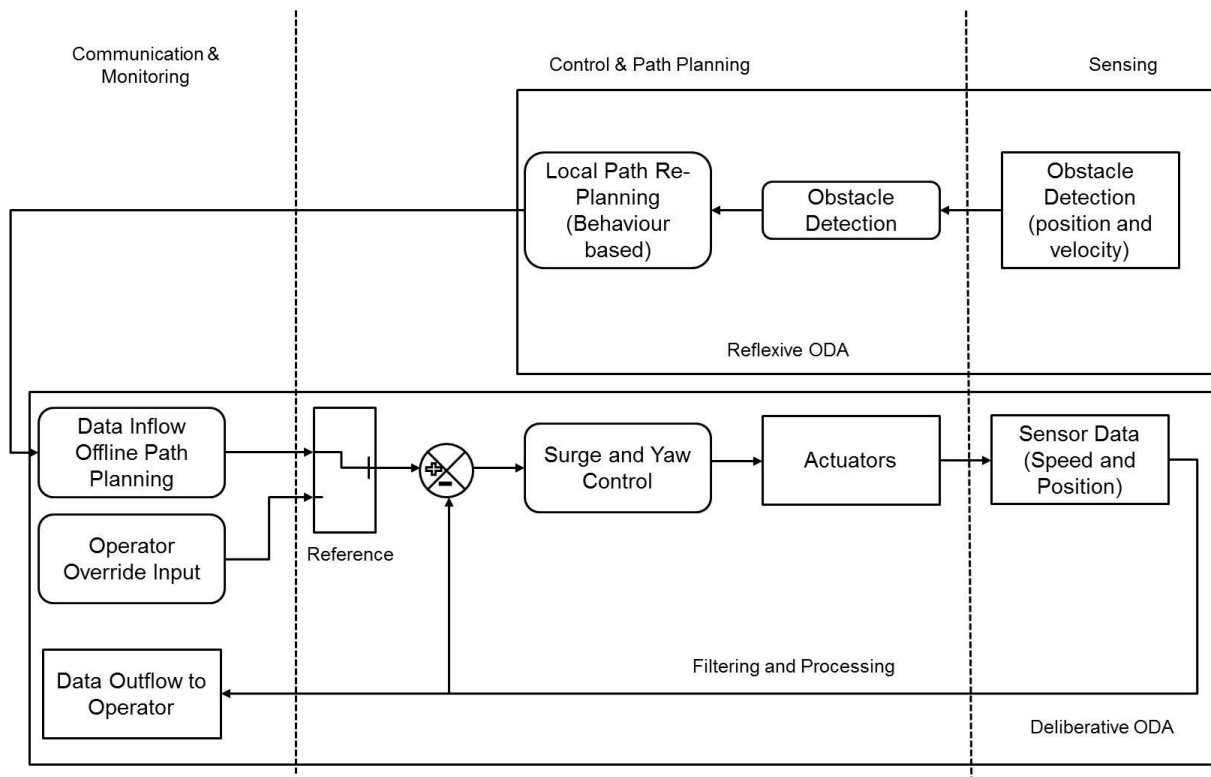

Figure 6: General architecture of USV operation in a maritime environment (Campbell and Naeem, 2012)

Path planning is an important subsystem of this architecture responsible for generating waypoints within a desired environment. The current study proposes an computationally effective and safer approach for generation of optimal waypoints for USV navigation in the desired environment. In order to plan and execute a mission in real-time, it is hereby important to interface the guidance and control subsystems with navigation methods and provide quick feedback to the guidance and control subsystems for effective decision making and higher autonomy.

Conventional waypoint guidance subsystems are designed by reducing surge, sway and yaw (3 DOF) to surge and heading (2 DOF) (Healey et al., 1992). Guidance is responsible to achieve motion control objectives in the physical environment in which the vehicle moves (Bibuli et al., 2009). The easiest way is to use a classical autopilot system, so that commanded yaw angle generated from a line-of-sight (LOS) guidance algorithm can be controlled (assuming sufficient bandwidth) and cross track error is minimized. The Fig.7 shows a way-point tracking control system implemented with a standard proportional integral derivative (PID) autopilot in series with a LOS algorithm.

The waypoints expressed in the current study are in terms of pixels which need to be converted to absolute location on earth by combining the latitude, longitude and elevation of the earth for real world navigation. The work of Massey (2006) shows that if the vehicle approaches waypoint with slight offset, it causes huge heading error ranging from 1-2 degrees to 80+ degrees primarily due to GPS heading, coordinate transformation and well as steady state error in the controller. A simple and robust approach to correct this problem involves defining a circle of specified radius around waypoint or the USV. The current study has adopted the approach of having a circle around USV with the USV being treated as a particle to solve this heading and path error. As soon as waypoint comes within that circle of USV, it is assumed that waypoint is safely achieved.

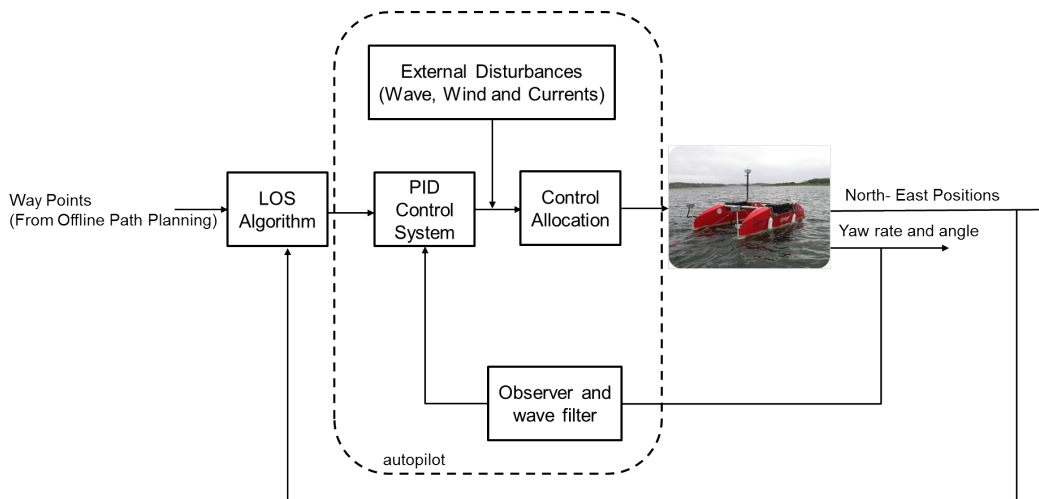

Figure 7: PID autopilot with a LOS projection algorithm for way-point tracking (Modified from Fossen et al. (2003))

In terms of autopilot and control system development, a detailed review of studies con-

ducted on USVs has been discussed by Roberts (2008). Many control techniques like H_∞ (Lefeber et al., 2003), linear quadratic Gaussian (LQG) (Sharma et al., 2012), model predictive control (MPC) (Annamalai et al., 2015) have been proposed recently, together with development of an adaptive control system (Sharma et al., 2014) towards making the controller effective for a range of USV speeds and operating sea conditions.

2.6. Collision avoidance in close encounter situation

The general architecture for a USV operation in a maritime environment described in Fig.6 shows that high level planners send waypoints to low level decision makers i.e. local control systems and obstacle avoidance subsystems to execute the waypoint following task. When a time variant moving obstacle enters the working domain of the operating USV, it is expected that high level planners quickly regenerates new set of way points based on the current information of the environment. Many other factors like relative velocity of the USV and the obstacle, the sensing horizon etc also plays an important role in such regeneration process. In such transition, it is hereby required to have a quick response time from the high level planners which is one of the main objectives of the current study.

In real-time operations, collision avoidance is the most important objective. Since the current study considers inland UK water for operation of USVs, it is imperative to follow the local guidelines towards the development of a path planner and collision avoidance with moving obstacles. To enable the safe and secure operation of autonomous surface ships within the existing IMO requirement, a code of practice has been prepared by the UK Maritime Autonomous Systems Working Group (MASRWG) and published by Maritime UK through the Society of Maritime Industries (UK, 2017). Under this code of practice, all autonomous ships working within the UK waters have 6 levels of autonomy as developed by the European Defence Agency as follows (UK, 2017):

1. Human on Board
2. Operated
3. Directed
4. Delegated
5. Monitored
6. Autonomous

The current state of operation of USVs is either at level 3 or level 4 of the autonomy, where there is always a human-in- the loop towards monitoring the operation of USVs. In a case where an unknown obstacle of uncertain trajectory and nature enters into the domain of the USV and collision cannot be avoided, a few emergency actions like abort and stop are employed in response to fault conditions.

3. Simulation Results

The proposed approach is simulated using C++ and OpenCV. All simulations are performed on a PC with *Microsoft* Windows 7 as OS with Intel i5 2.70 GHz quad core CPU

and 16 GB RAM. The simulations were repeated for 500 times, especially in terms of computational time, to account for variable computational power in OS Windows. The average time from all repetitions was calculated for proper verification of the proposed approach.

3.1. Comparing A* approach with and without safety distance

The proposed study deals with inclusion of a safety distance criteria in the A* approach towards USV path planning. In order to benchmark the safety distance approach and to decide upon an optimum value of safety distance, four arbitrary values, 10, 20, 30 and 40 pixels are taken as safety distance on a grid map (as shown in Fig. 2) and compared against an A* approach without safety distance in terms of computational time. The start and goal states used in the path planning system are depicted on the binary map as shown in Fig. 9.

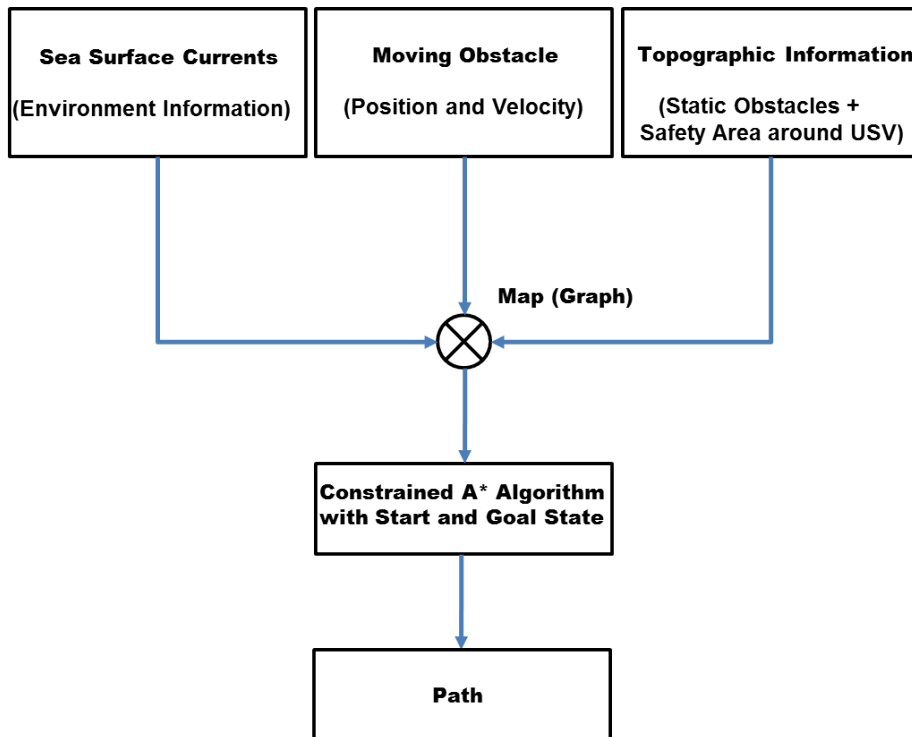

Figure 8: Schematic of the proposed path planning system

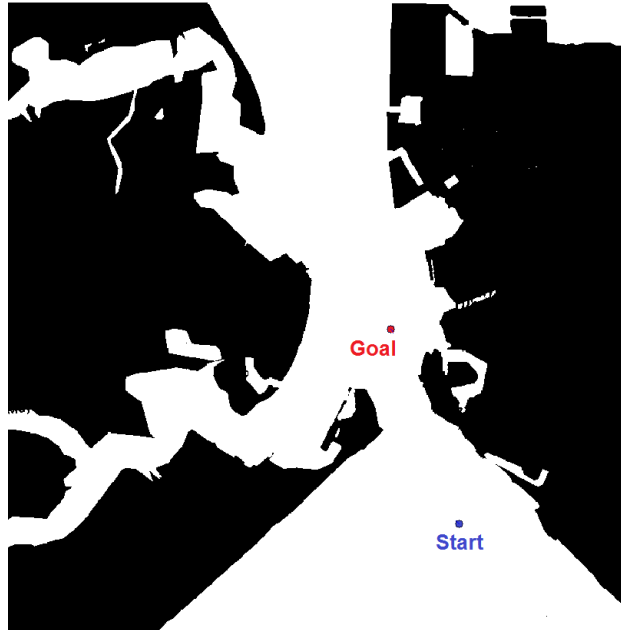

Figure 9: Binary Map with Start and Goal States

Fig.10 shows the comparison of A* approach with and without safety distance constraint in terms of computational time. The results show that on a R^2 grid map, a larger safety distance constraint produces computationally efficient path in a A* approach against paths produced without such constraint. This is due to the fact that search process explores lesser number of nodes with safety distance than without safety distance by pruning the search domain.

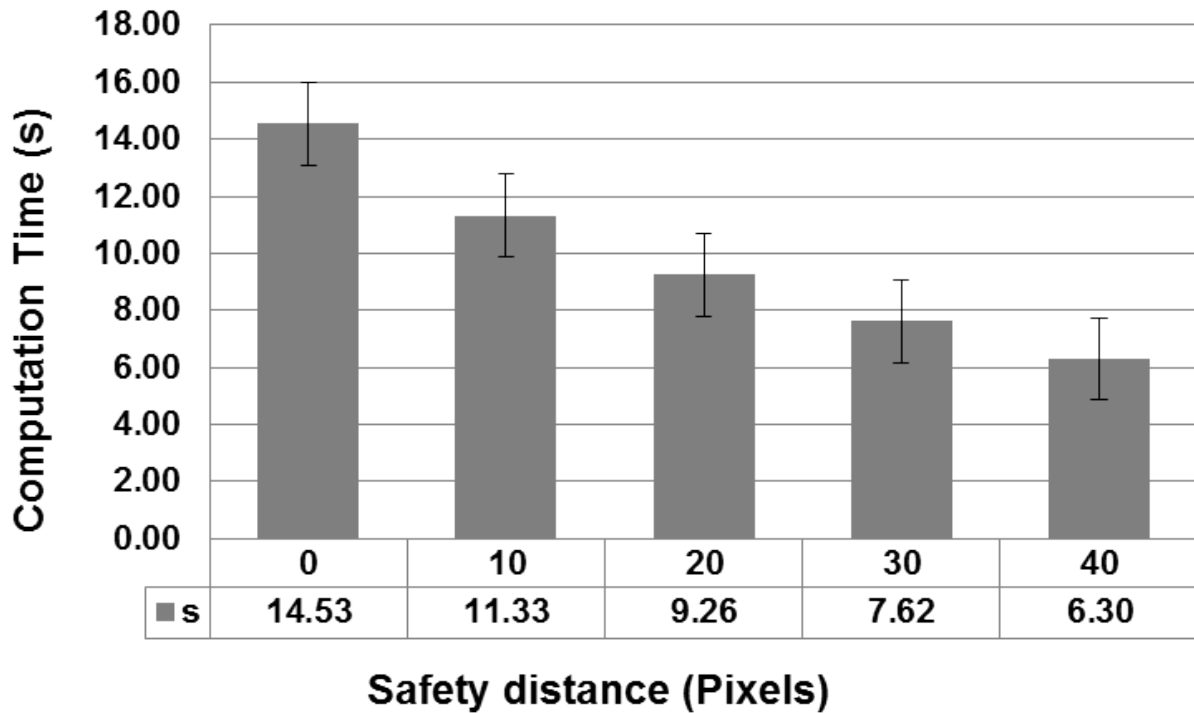

Figure 10: Compared computational time of A* approach with and without safety distance constraint. The interval on each bar denotes the standard deviation of the computational time

In terms of path length, simulations shows that the A* approach with and without safety distance constraint produces path of equal length i.e. 1.043 km although a difference in resultant path can be seen in Fig.11. This difference in resultant paths is less visible in smaller safety distance values while a more noticeable difference is observed in paths produced with larger safety distance. This leads to the fact that optimality remains conserved in path planning with decrease in computational effort in the proposed approach unlike ones adopted in literature towards path planning of USVs where an increase in computational cost has been observed with increase in path length for proposed approaches.

Since the current study considers a narrow channel of Portsmouth harbour for path planning of USV, henceforth, it becomes necessary to choose a safety distance where a proper trade off between computational time and safety distance from an obstacle can be maintained. Therefore, a 20 pixel safety distance (72 m on real map) has been chosen for the present study. This value also provides enough time for local reactive techniques for collision avoidance in case where one or more moving obstacles are detected in the operational domain of the USV.

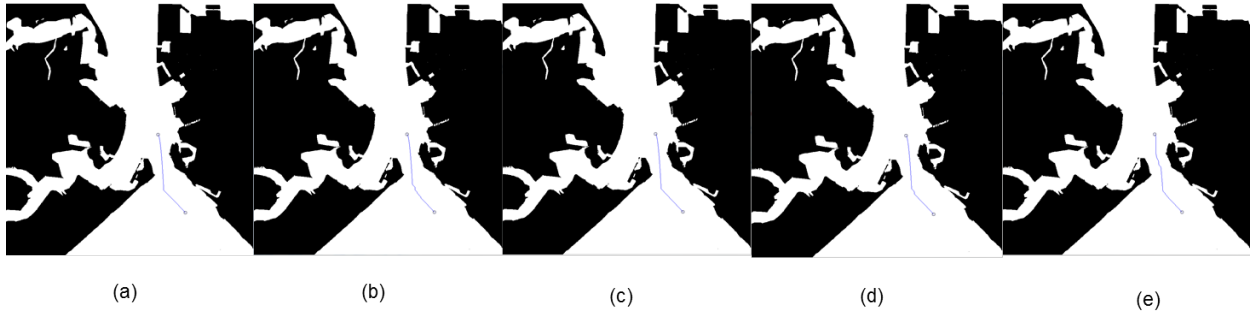

Figure 11: Resultant path with safety distance of (a) 0 (b) 10 (c) 20 (d) 30 (e) 40 pixels

3.2. Constrained A^* approach under static and partially dynamic environment

In order to understand the effectiveness of the proposed approach, simulations are conducted in binary maps of Portsmouth harbour comprising of static obstacles as well as moving obstacles. Such an environment which consists of moving and stationary obstacles is termed as a partially dynamic environment. The effectiveness is defined in terms of path length and computational time obtained in simulations. In simulations, a stationary map with one and two moving obstacles for a constrained channel having start and goal points as defined in Fig.12 in Portsmouth harbour has been considered. A binary map of the simulation area with single and two moving obstacles is shown in Fig.13.

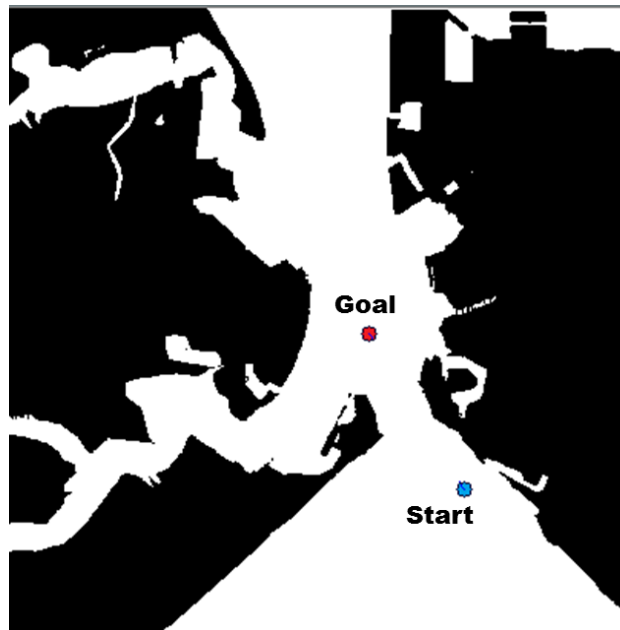

Figure 12: Binary map with start and goal states for simulating A^* approach under static and partially dynamic environment



Figure 13: Binary map of the simulation area (Portsmouth harbour) showing velocity and direction of moving obstacles. In this study, 20 pixels has been chosen as the safety distance around an USV.

Modelling of dynamic obstacles on a map for maritime path planning is defined in terms of the velocity of the moving obstacle in maritime environment. Liu and Bucknall (2015) has suggested a circular shape for slow moving obstacles and elliptical shapes for fast moving obstacles. Therefore, an elliptical shape as shown in Fig.14 has been adopted in the current study.

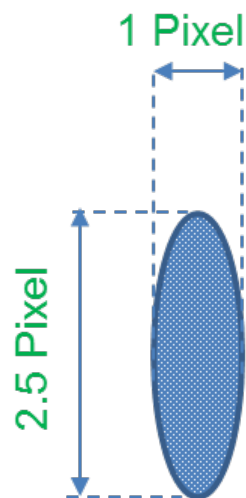

Figure 14: Dimension of the elliptical domain representing the encapsulation of a moving obstacle in a static one in the binary map. The dimensions of ellipse are chosen in accordance with the dimensions of high speed craft having operational velocity range from 6 to 9 knots

The results presented in Fig.15 shows path generated by the proposed approach in different scenarios of single moving obstacle. The scenarios presented in the figure shows a single moving obstacle moving in a straight line at a velocity of 6 knots, based upon its start point shown in Fig.13 and considers each instantaneous dynamic situation as static (based on the conventional method adopted in deliberative path planning by Borenstein and Koren (1991)). Path length and computational time are computed for each start time of the mission and results are shown in Fig.16 and Fig.17. It is found that as the moving obstacle approaches the safety domain of the USV, an increase in path distance is observed.

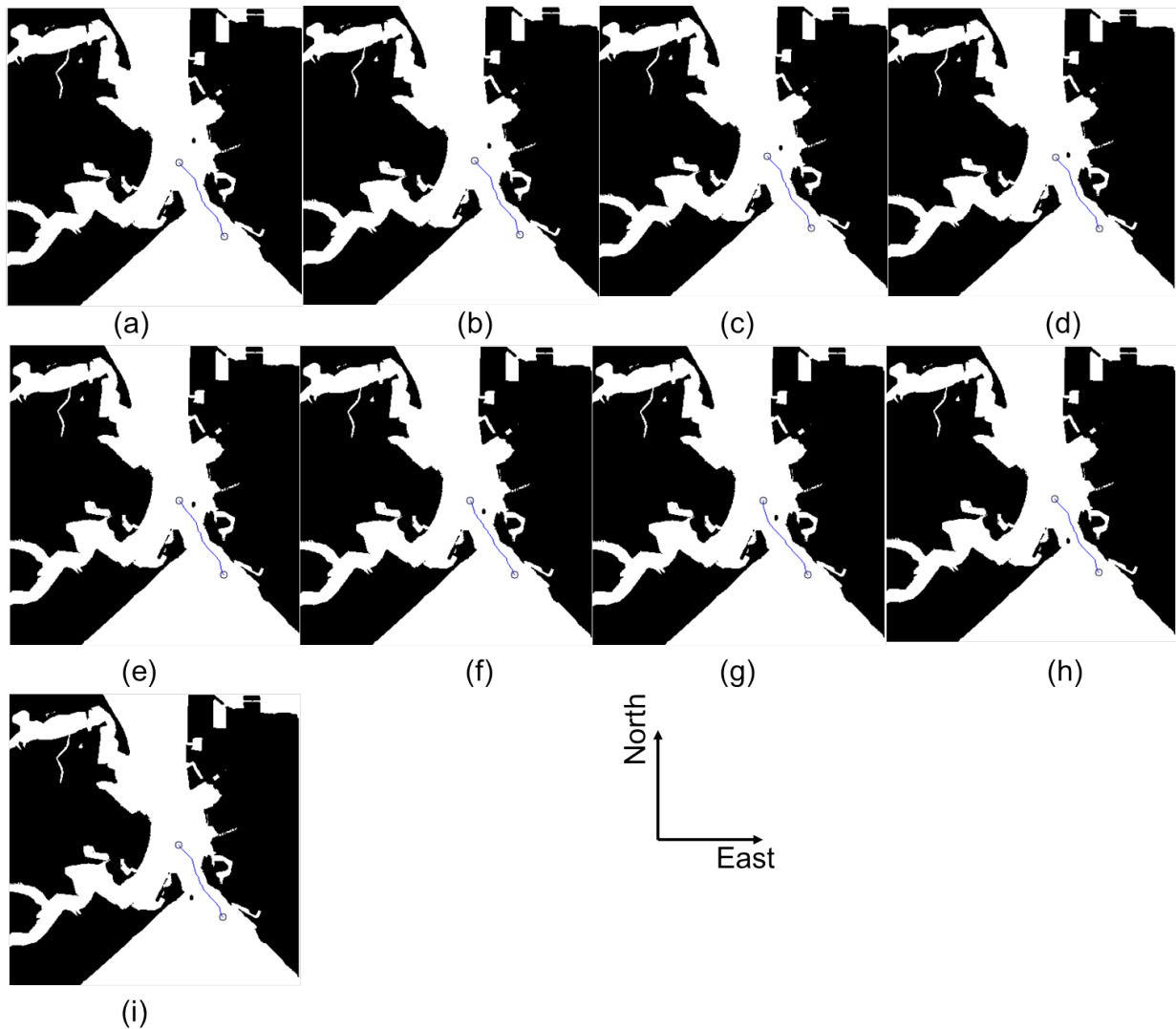

Figure 15: Comparison of paths obtained with different start time (a) 0 (b) 10 (c) 20 (d) 30 (e) 40 (f) 50 (g) 60 (h) 100 (i) 120 seconds. Position of the single moving obstacle is plotted at each start time on the binary map, based on the velocity and direction mentioned in Fig.13

This is owing to the fact that vehicle moves further east, as shown in Fig.15(h), to

maintain the constraint of keeping a safety distance of 20 pixels. In addition to that a decrease in computational effort is observed with increase in path length once the moving obstacle is detected within the safety domain of USV. This is because the search space in the gridded map gets pruned in the proposed approach which leads to generation of longer path length with decrease in computational time. The computational time again increases once the moving obstacle escapes out of the safety domain of the USV.

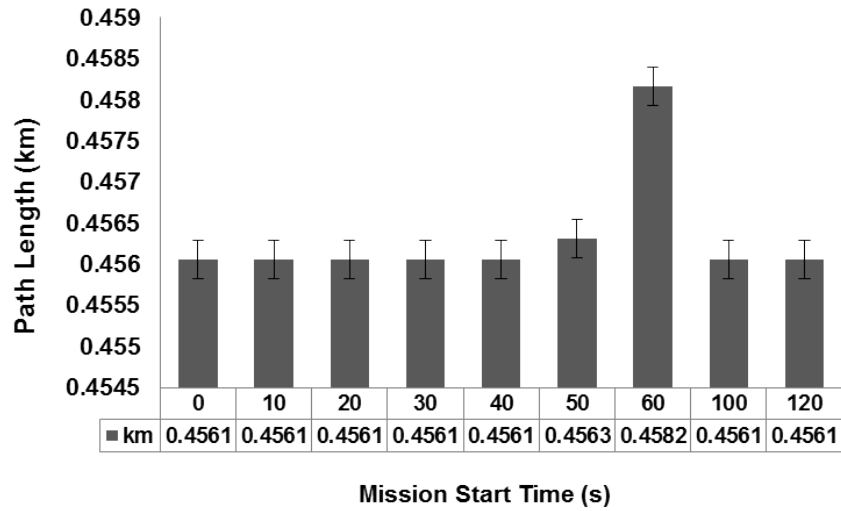

Figure 16: Comparison of path length obtained with different start time (a) 0 (b) 10 (c) 20 (d) 30 (e) 40 (f) 50 (g) 60 (h) 100 (i) 120 seconds. A safety distance constraint of 20 pixel is maintained for all scenarios in the figure. The interval on each bar denotes the standard deviation of the path length

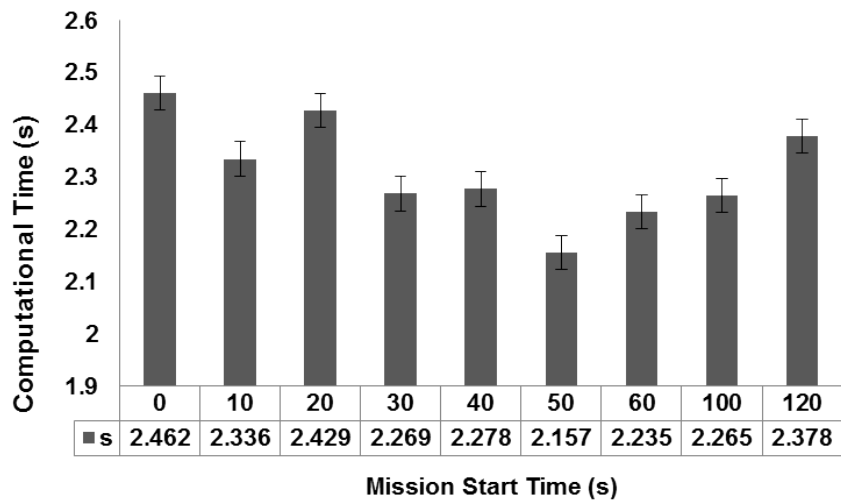

Figure 17: Comparison of computational time obtained with different start time (a) 0 (b) 10 (c) 20 (d) 30 (e) 40 (f) 50 (g) 60 (h) 100 (i) 120 seconds. The interval on each bar denotes the standard deviation of the computational time

In order to make the environment more complex and more cluttered, a scenario with two moving obstacles is considered for understanding the effectiveness of the proposed approach as shown in Fig.13(right side). The results shown in Fig.18 shows path generated by proposed approach in different scenarios of an maritime environment with two moving obstacles. The scenarios presented in the figure shows both moving obstacles are moving in a straight line at a velocity of 6 knots, based upon their start points shown in Fig.13.

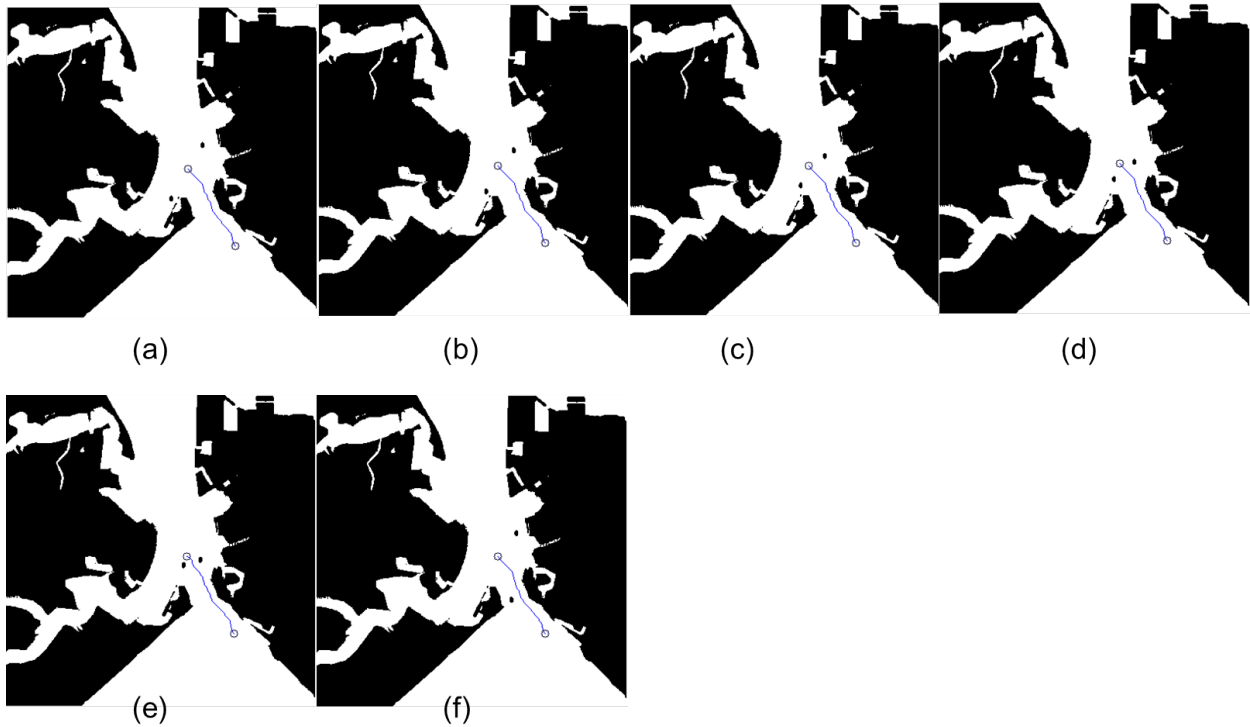

Figure 18: Comparison of paths obtained with different start time (a) 0 (b) 10 (c) 20 (d) 30 (e) 40 (f) 100 seconds. A safety distance constraint of 20 pixel is maintained for all scenarios in the figure. Position of both moving obstacles is plotted at each start time on the binary map, based on the velocity and direction mentioned in Fig.13.

In this case also the same pattern as found with the single moving obstacle scenario is observed. The comparison of path length and computational time is shown in Fig.19 and Fig.20 respectively. The path length increases once the moving obstacles approaches the safety domain of the USV in order to maintain the safety distance constraint. This fact is reflected in the resultant paths obtained in different scenarios where a change in resultant path is obtained when moving obstacle approaches USV. With increase in path length, a decrease in computational time is observed. The computational time retains the increased value once the moving obstacles escape out of the safety domain of the USV.

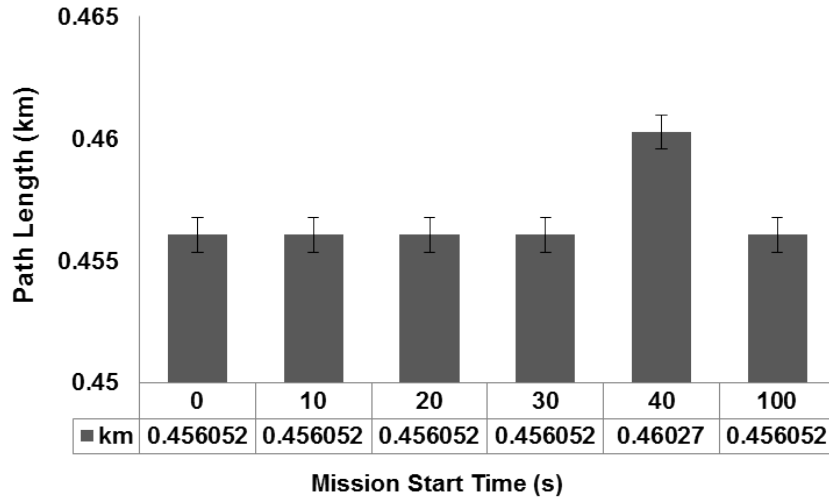

Figure 19: Comparison of path length obtained with different start time 0, 10, 20, 30, 40 and 100 seconds. The interval on each bar denotes the standard deviation of the path length

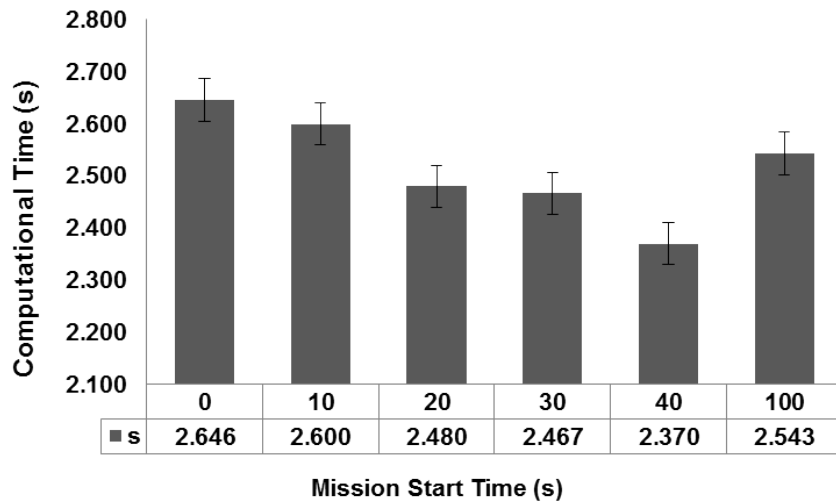

Figure 20: Comparison of computational time obtained with different start time of 0, 10, 20, 30, 40 and 100 seconds. The interval on each bar denotes the standard deviation of the computational time

3.3. Constrained A^* approach with environmental disturbances

Ocean currents generated in the upper layer of the ocean environment by atmospheric wind system are referred as sea surface currents (Fossen, 1995). In the current study, the effect of steady non uniform headwind and tailwind currents on USV navigation has been studied for the proposed approach. In general, ocean currents are provided in a NetCDF data format by various meteorological agencies around the world. Such data obtained from satellites have a resolution of 2 km (Bonnett and Campbell, 2002) while the range of most navigation devices is less than 5 nmi which makes such data low in precision and not suitable

for USV path planning. Hence, the synthetic vector field of moderate and strong intensity is created within the map to verify the effect of current on optimal path planning. Real ocean currents are multi-directional and irregular, spatially and temporally. In the present study, current effect on USV path planning is simplified as a constant disturbance by assuming the current to be unchanged over a period of time (Antonelli et al., 2008). Two current scenarios, a moderate current intensity of 1.5 m/s and a strong current intensity of 2.5 m/s is considered for the present study. These values are chosen on observation of high speed currents of 2 to 3 m/s in coastal regions (Fossen, 1995).

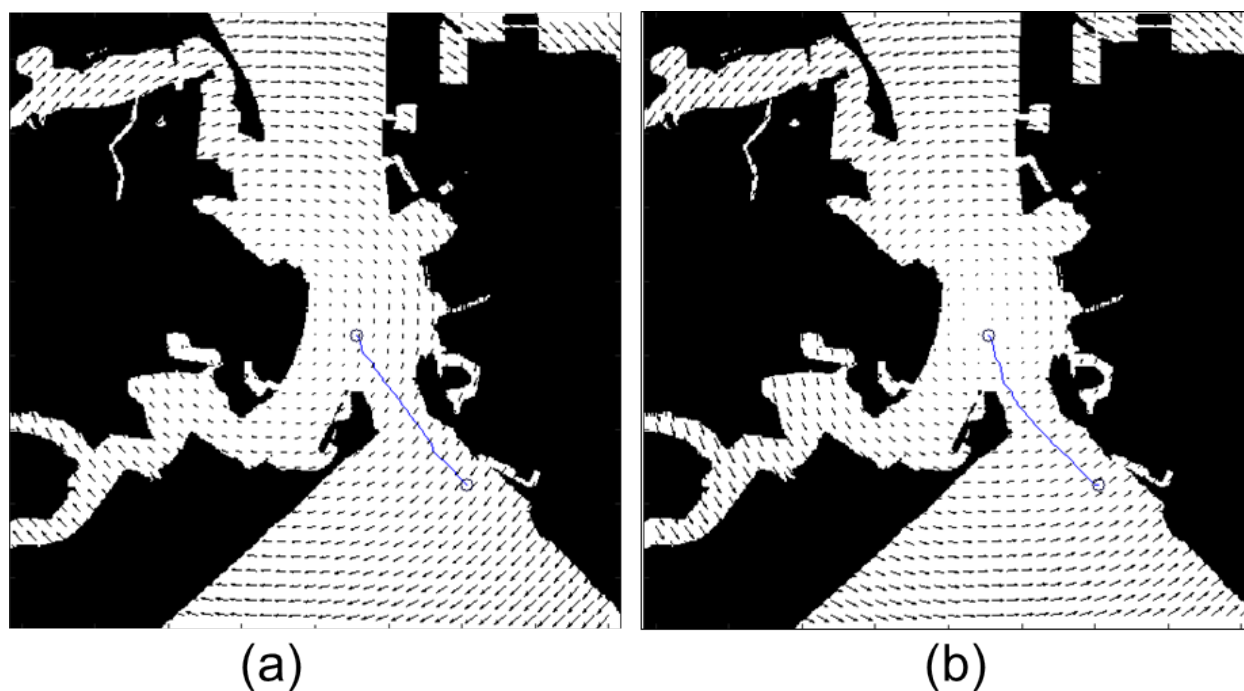

Figure 21: Comparison of paths obtained for currents moving with intensity of 1.4 m/s in (a) anti-clockwise and (b) clockwise direction. The start and goal states are same as shown in Fig.12. The safety distance constraint of 20 pixels is maintained for both scenarios.

In order to understand the steady non uniform headwind and tailwind effects of current on path planning, clockwise and anti-clockwise directions of chosen intensity values are taken in the present study. Fig.21 shows the path obtained by the proposed approach with currents moving in anti-clockwise and clockwise direction with intensity of 1.4 m/s. Path length and computational time are compared for both scenarios shown in Fig.21 and results are presented in Fig.22 and Fig.23 respectively. The results shows that when the USV operates in steady non uniform tailwind currents, it has to cover a larger distance in current while a smaller distance is observed in steady non uniform headwind currents. This is due to the fact that presence of steady non uniform tailwind currents in the USV voyage creates larger forces in the sway motion, directing the USV to move closer to the shore line (as seen in Fig.21(a)), which leads to generation of a path with a longer curvature. The current

approach has been able to demonstrate a decrease in computational effort to find path when higher distance voyages are observed under influence of sea surface currents.

Along the same line, currents of 2.5 m/s are considered to understand the path planning pattern of USV under influence of strong ocean currents. Fig.24 shows the path obtained by the proposed approach with currents moving in anti-clockwise and clockwise direction with intensity of 2.5 m/s. Path length and computational time are compared for both scenarios shown in Fig.24 and results are shown in Fig.25 and Fig.26 respectively. In this case also, a similar pattern as found with 1.4 m/s has been observed. In terms of current intensities of different magnitude moving in same direction (from a comparison of path length values for AC currents in Fig.22 and Fig.24), it has been found that currents of higher magnitude are more favourable in minimizing energy usage for USV voyage with a no substantial increase in computational effort. This leads to the fact that proposed approach can assist USV in utilizing the ocean environment intelligently to minimize energy usage by integrating current information with path planner.

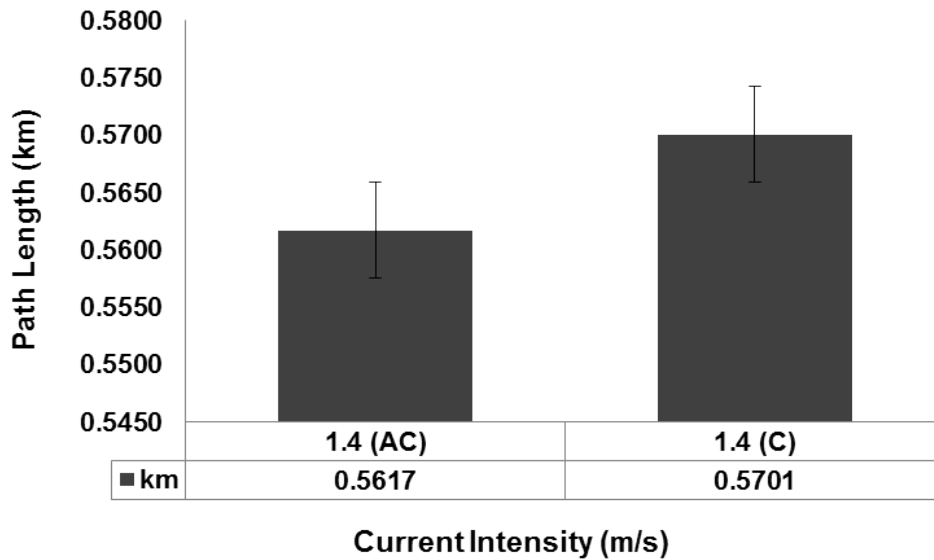

Figure 22: Comparison of path length obtained for currents moving with intensity of 1.4 m/s in anticlockwise (AC) and clockwise (C) directions. The interval on each bar denotes the standard deviation of the path length.

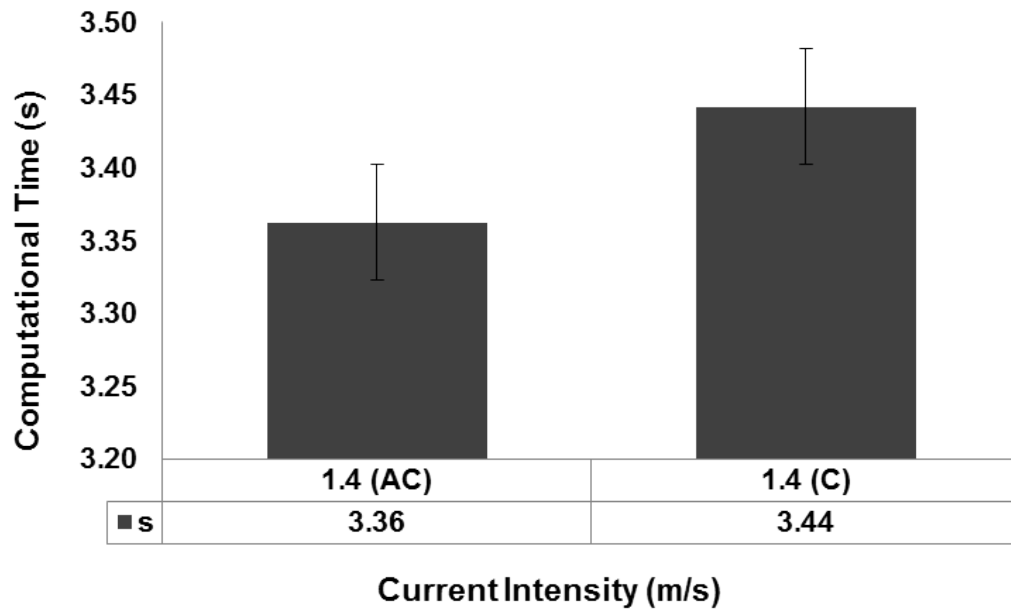

Figure 23: Comparison of computational time to determine path obtained for currents moving with intensity of 1.4 m/s in anticlockwise (AC) and clockwise (C) directions. The interval on each bar denotes the standard deviation of the computational time.

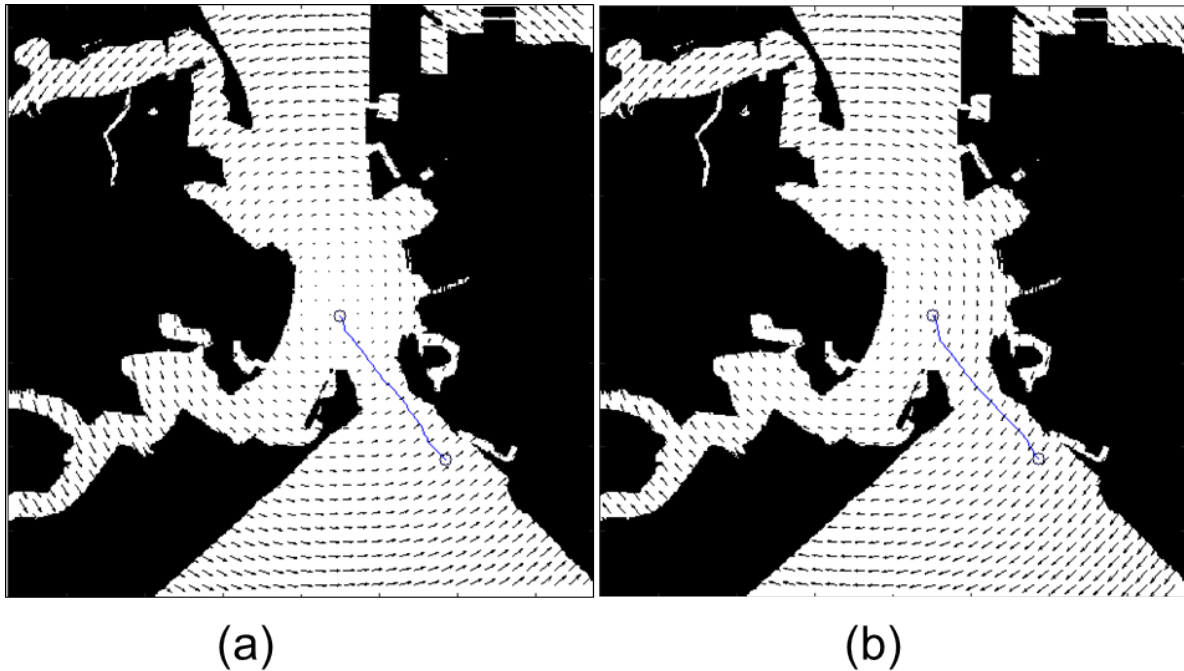

Figure 24: Comparison of paths obtained for currents moving with intensity of 2.5 m/s in (a) anti-clockwise and (b) clockwise direction. The start and goal states are same as shown in Fig.12. The safety distance constraint of 20 pixels is maintained for both scenarios.

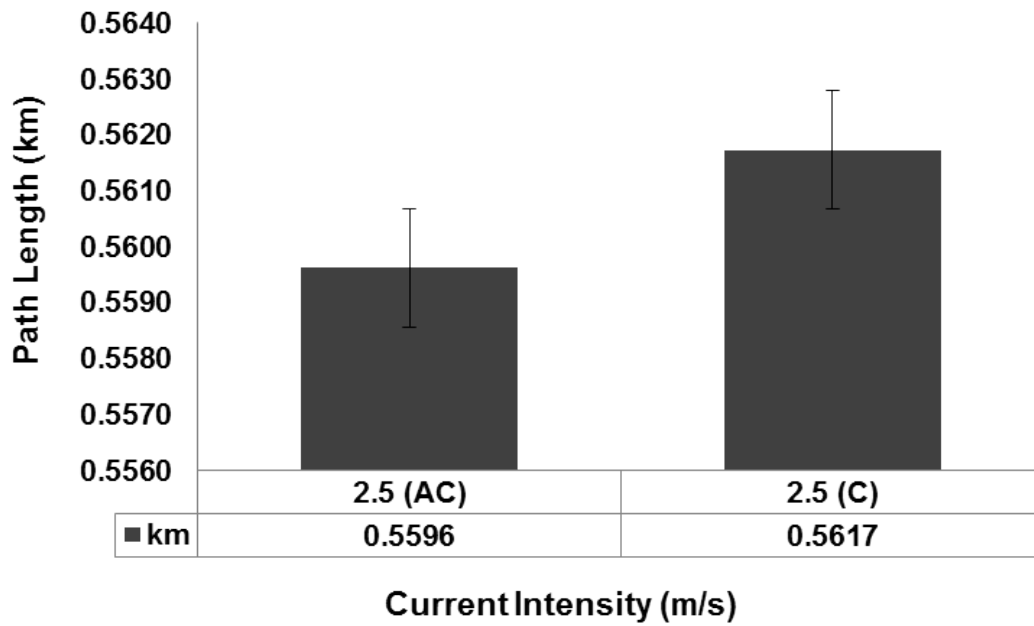

Figure 25: Comparison of path length obtained for currents moving with intensity of 2.5 m/s in anticlockwise (AC) and clockwise (C) directions. The interval on each bar denotes the standard deviation of the path length.

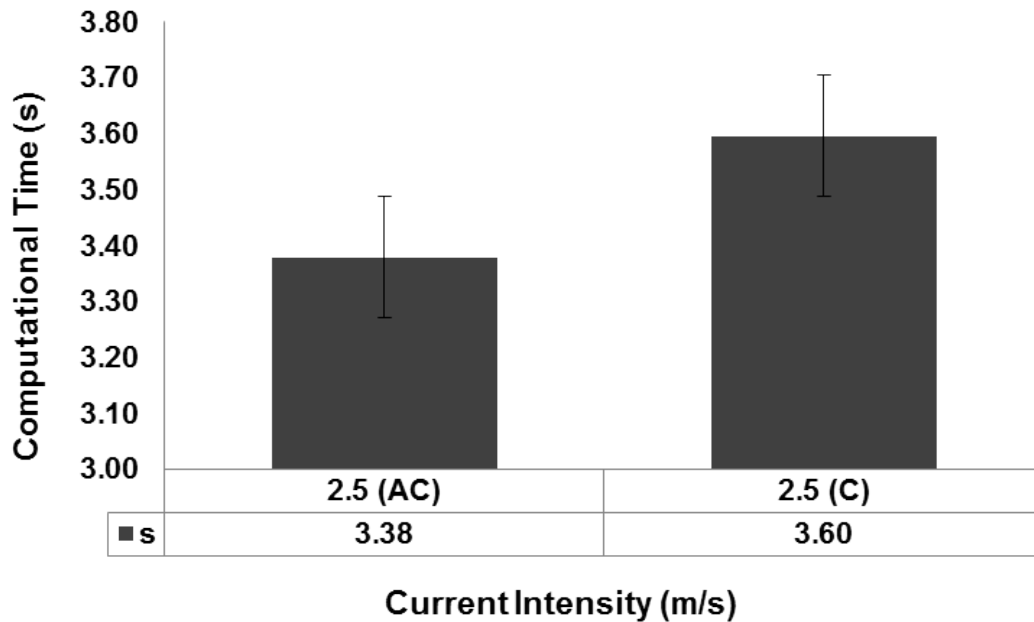

Figure 26: Comparison of computational time to determine path obtained for currents moving with intensity of 2.5 m/s in anticlockwise (AC) and clockwise (C) directions. The interval on each bar denotes the standard deviation of the computational time.

3.4. Constrained A^* approach with single moving obstacle and environmental disturbance

In order to create a more complete picture of the operational environment near to Portsmouth harbour and to analyse the effectiveness of the proposed approach in cluttered environment, a single moving obstacle is introduced in the map in presence of sea surface currents of moderate intensity as discussed in Sec.3.3. Since the complexity of the environment has increased, a more flexible safety distance constraint of 15 pixel has been adopted for this study in order to keep a proper trade off between optimal way points and environmental complexity. Fig.28 shows the generated paths for different start time in the environment comprising of static obstacle, sea surface currents of 1.4 m/s moving in anti-clockwise direction and moving obstacle (where each dynamic position is considered static). Comparison of path length and computational time for all scenarios presented in Fig.28 are shown in Fig.27 and Fig.29 respectively.

From the results obtained, one can observe that as the obstacle approaches the safety domain of the USV, there is a increase in path length observed with a decrease in computational effort for cases (as found with mission start time of 30 seconds and 60 seconds), where, an increased path length is observed. In addition to that, most cases have been able to generate path within a reasonable computational time. These results show that the proposed algorithm can generate safer way points for the USV voyage for long and short duration missions in a cluttered complex environment.

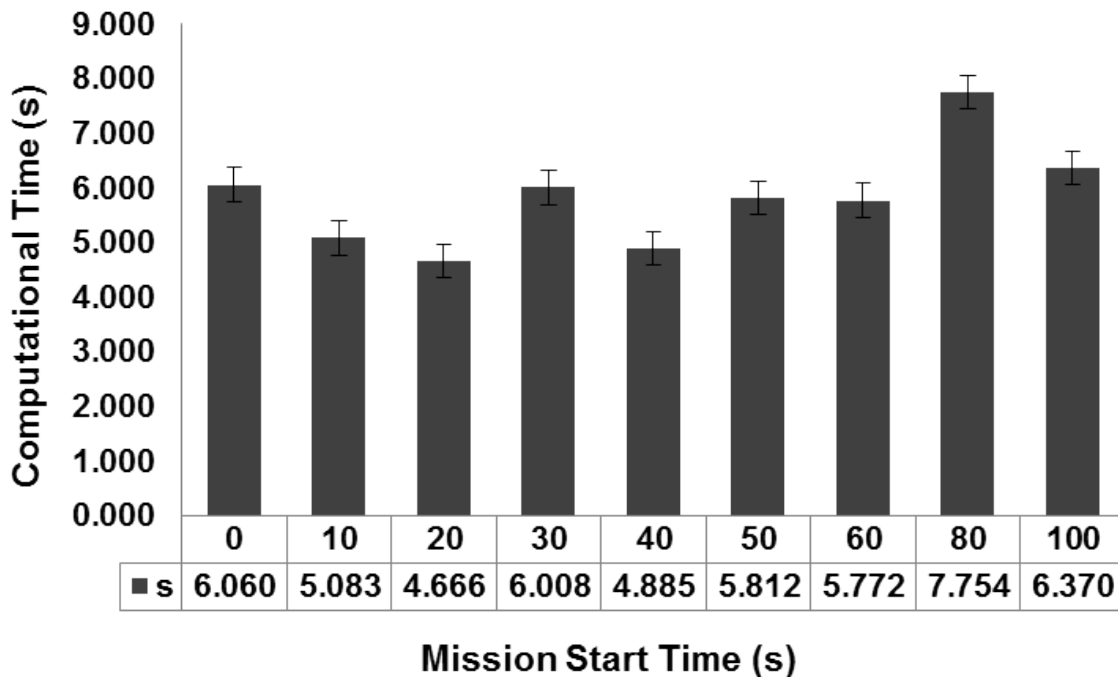

Figure 27: Comparison of computational time obtained for scenario with sea surface currents of 1.4 m/s moving in anti-clockwise direction having a moving obstacle for different start time of 0, 10, 20, 30, 40, 50, 60, 80 and 100 seconds. The interval on each bar denotes the standard deviation of the computational time.

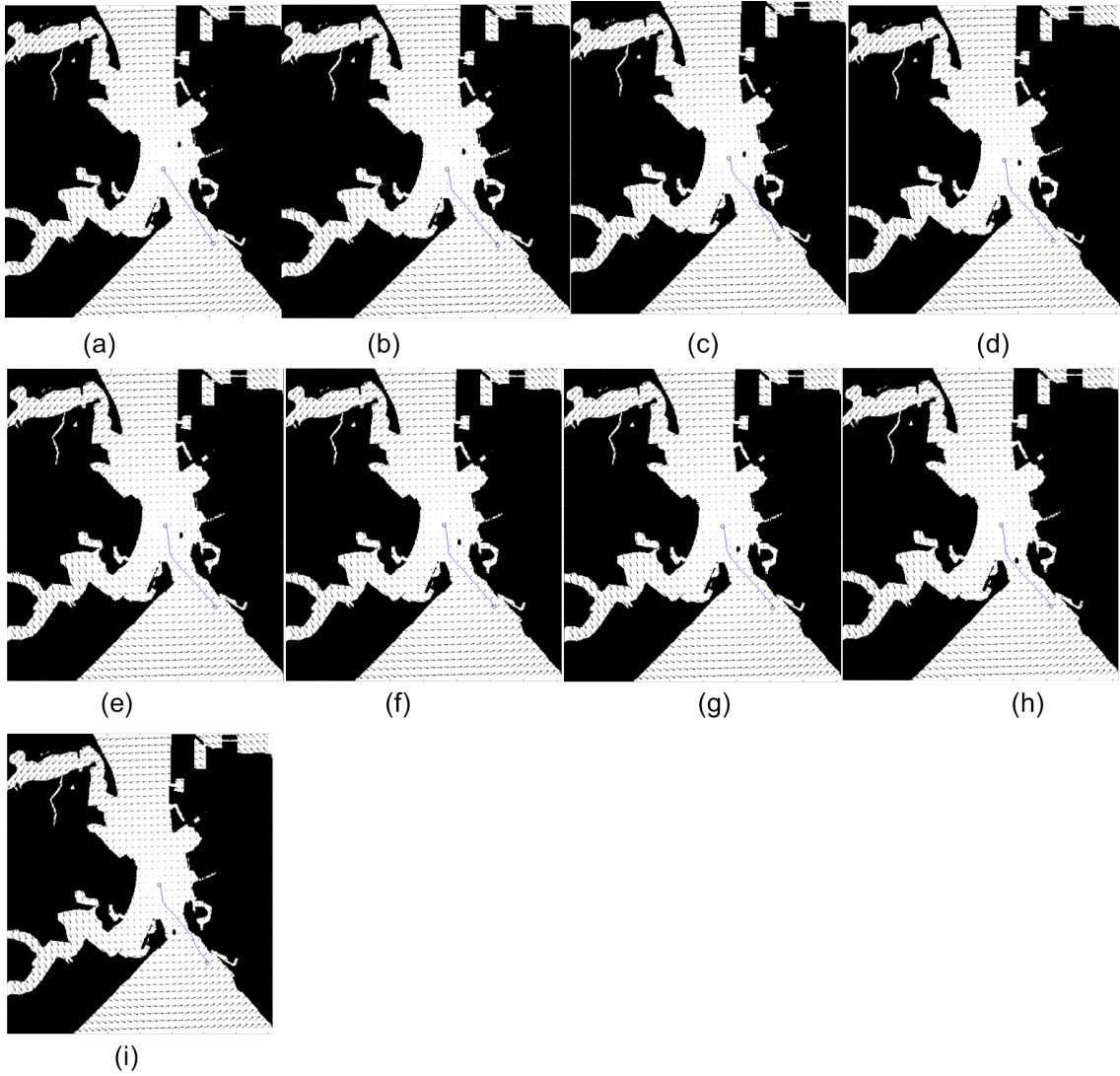

Figure 28: Comparison of paths obtained for scenario with sea surface currents of 1.4 m/s moving in anti-clockwise direction having a moving obstacle for different start time of (a) 0 (b) 10 (c) 20 (d) 30 (e) 40 (f) 50 (g) 60 (h) 80 (i) 100 seconds. The start and goal states are same as shown in Fig.12. The safety distance constraint of 15 pixels is maintained for all scenarios.

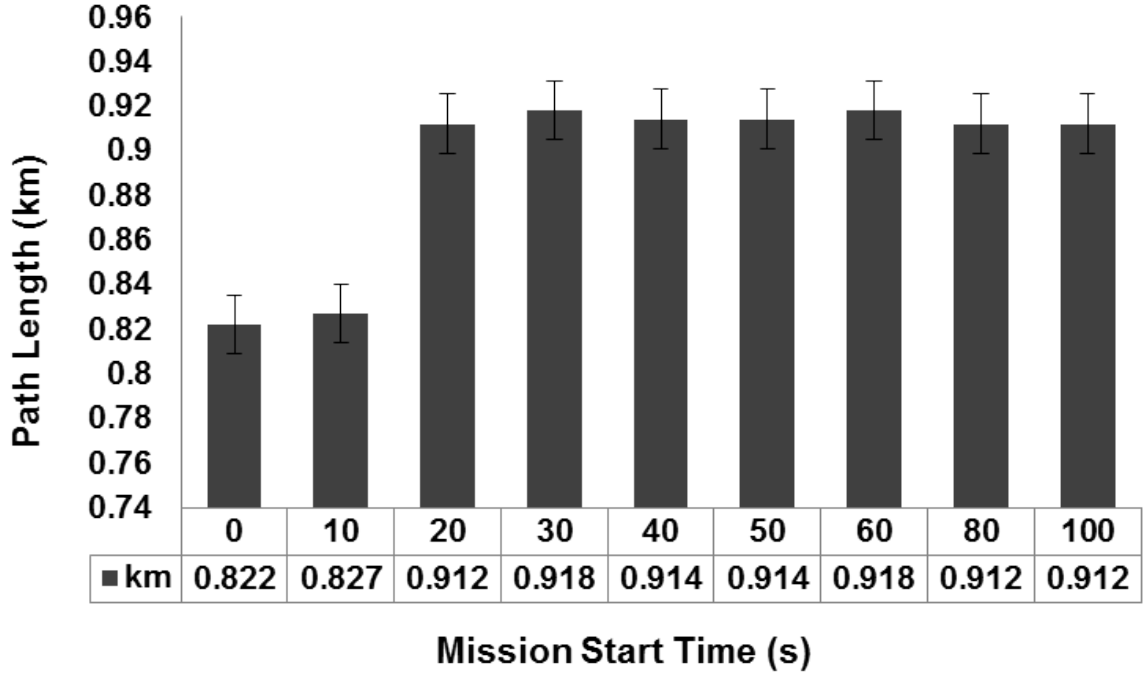

Figure 29: Comparison of path length obtained for scenario with sea surface currents of 1.4 m/s moving in anti-clockwise direction having a moving obstacle for different start time of 0, 10, 20, 30, 40, 50, 60, 80 and 100 seconds. The interval on each bar denotes the standard deviation of the path length.

4. Conclusions

In this paper, a constrained A* approach for optimal path planning of USVs in a confined maritime environment is proposed. The objective of generating safer way points by keeping a safe distance from the obstacle was evaluated in simulations, conducted in various environments comprising of static obstacle, moving obstacle and sea surface currents of different intensities. The upstream and effects of sea surface currents was evaluated and effect of sea surface currents with moving obstacle was also analysed. The simulation results shows that the present approach generates safer way points for USV voyage in a computationally efficient manner against the conventional A* approach with no loss of optimality. The approach is found to be robust, computationally efficient and can be extended for real time path planning of USVs in confined water. In conclusion it is considered, such an optimal approach is suitable for global path planning of USVs. In future work, it is planned to extend the work in development of a path follower approach working in conjugation with proposed approach for a reactive path planning in scenarios involving close encounters. Another extension of the present work lies in considering heading angle constraint for USV, in such cases, where, path length is more important than computational time. This converts the problem from a R^2 to a $SE(2)$ path planning approach.

Most leading companies in USV operations are looking for the integration of COLREGs with optimal path planners to abide the working guidelines of the IMO. A challenging

extension of the current work lies in fact of finding a heuristic cost function which can take into account rules of the COLREGs without compromising the optimality and computational effort required to find a feasible trajectory.

5. Acknowledgements

The authors would like to thank Commonwealth Scholarship Commission (CSC), United Kingdom for funding the doctoral studies at University of Plymouth.

References

- Aghababa, M.
2012. 3D path planning for underwater vehicles using five evolutionary optimization algorithms avoiding static and energetic obstacles. *Applied Ocean Research*, 38:48–62.
- Alvarez, A., A. Caiti, and R. Onken
2004. Evolutionary path planning for autonomous underwater vehicles in a variable ocean. *IEEE Journal of Oceanic Engineering*, 29(2):418–429.
- Annamalai, K., R. Sutton, C. Yang, P. Culverhouse, S. Sharma, et al.
2015. Robust adaptive control of an uninhabited surface vehicle. *Journal of Intelligent & Robotic Systems*, 78(2):319.
- Antonelli, G., T. Fossen, and D. Yoerger
2008. Underwater robotics. In *Springer handbook of robotics*, Pp. 987–1008. Springer.
- Azariadis, P. and N. Aspragathos
2005. Obstacle representation by bump-surfaces for optimal motion-planning. *Robotics and Autonomous Systems*, 51(2-3):129–150.
- Belcher, D.
2007. Education in flight: A teachers guide to the mathematics of flight.
- Bibuli, M., G. Bruzzone, M. Caccia, and L. Lapiere
2009. Path-following algorithms and experiments for an unmanned surface vehicle. *Journal of Field Robotics*, 26(8):669–688.
- Bonnett, R. and J. Campbell
2002. *Introduction to remote sensing*, 3rd Edition. CRC Press.
- Borenstein, J. and Y. Koren
1991. The vector field histogram-fast obstacle avoidance for mobile robots. *IEEE transactions on robotics and automation*, 7(3):278–288.
- Campbell, S. and G. Naeem, Wand Irwin
2012. A review on improving the autonomy of unmanned surface vehicles through intelligent collision avoidance manoeuvres. *Annual Reviews in Control*, 36(2):267–283.
- Casalino, G., A. Turetta, and E. Simetti
2009. A three-layered architecture for real time path planning and obstacle avoidance for surveillance USVs operating in harbour fields. In *Oceans 2009-Europe*, Pp. 1–8. IEEE.
- David, F. and S. Anthony
2005. The field d* algorithm for improved path planning and replanning in uniform and non-uniform cost environments. Technical Report CMU-RI-TR-05-19, Pittsburgh, PA.
- Dijkstra, E.
1959. *Communication with an Automatic Computer*. PhD thesis, University of Amsterdam.
- Duchoň, F., A. Babinec, M. Kajan, P. Beňo, M. Florek, T. Fico, and L. Jurišica
2014. Path planning with modified a star algorithm for a mobile robot. *Procedia Engineering*, 96:59–69.
- Fiorini, P. and Z. Shiller
1998. Motion planning in dynamic environments using velocity obstacles. *The International Journal of Robotics Research*, 17(7):760–772.

- Fossen, T.
1995. *Guidance and Control of Ocean Vehicles*. New York, NY: Wiley.
- Fossen, T. I., M. Breivik, and R. Skjetne
2003. Line-of-sight path following of underactuated marine craft. *IFAC Proceedings Volumes*, 36(21):211–216.
- Garau, B., A. Alvarez, and G. Oliver
2005. Path planning of autonomous underwater vehicles in current fields with complex spatial variability: an A* approach. In *Robotics and Automation, 2005. ICRA 2005. Proceedings of the 2005 IEEE International Conference on*, Pp. 194–198. IEEE.
- Garrido, S. and L. Moreno
2016. Cálculo de trayectorias para vehículos autónomos marinos (USV) utilizando el método fast marching square sometido a campo vectorial. In *XXXVII JORNADAS DE AUTOMATICA, Madrid*.
- Hart, P., N. Nilsson, and B. Raphael
1968. A formal basis for the heuristic determination of minimum cost paths. *IEEE Transactions on Systems, Science, and Cybernetics*, SSC-4(2):100–107.
- Hart, P., N. Nilsson, and B. Raphael
1972. Formal basis for the heuristic determination of minimum cost paths”. *SIGART Bull.*, December 1972(37):28–29.
- Healey, A. J., D. Marco, et al.
1992. Slow speed flight control of autonomous underwater vehicles: Experimental results with nps auv ii. In *The Second International Offshore and Polar Engineering Conference*. International Society of Offshore and Polar Engineers.
- Holland, J.
1992. Genetic algorithms. *Scientific american*, 267(1):66–73.
- IMO
1988. Code on intact stability for all types of ships. *A.749 (18), amended by resolution MSC.75l*, 69.
- IMO
1995. Guidance to the master for avoiding dangerous situations in following and quartering seas. *MSC/Circ.707*.
- IMO
2007. Revised guidance to the master for avoiding dangerous situations in adverse weather and sea conditions. *MSC/Circ.1228*.
- Kennedy, J.
2011. Particle swarm optimization. In *Encyclopedia of machine learning*, Pp. 760–766. Springer.
- Khatib, O.
1986. Real-time obstacle avoidance for manipulators and mobile robots. *Int. J. Rob. Res.*, 5(1):90–98.
- Kim, H., D. Kim, J. Shin, H. Kim, and H. Myung
2014. Angular rate-constrained path planning algorithm for unmanned surface vehicles. *Ocean Engineering*, 84(Supplement C):37 – 44.
- Kim, H., T. Lee, H. Chung, N. Son, and H. Myung
2012. Any-angle path planning with limit-cycle circle set for marine surface vehicle. In *Robotics and Automation (ICRA), 2012 IEEE International Conference on*, Pp. 2275–2280. IEEE.
- Knight, R.
2008. The bicyclist’s paradox. *The Physics Teacher*, 46(5):275–279.
- Koenig, S. and M. Likhachev
2002. D* lite. *AAAI/IAAI*, 15.
- Kruger, D., R. Stolkin, A. Blum, and J. Briganti
2007. Optimal AUV path planning for extended missions in complex, fast-flowing estuarine environments. In *Robotics and Automation, 2007 IEEE International Conference on*, Pp. 4265–4270. IEEE.
- Kumar, R. P., A. Dasgupta, and C. Kumar
2005. Real-time optimal motion planning for autonomous underwater vehicles. *Ocean engineering*,

- 32(11):1431–1447.
- Kuwata, Y., M. Wolf, D. Zarzhitsky, and T. Huntsberger
 2014. Safe maritime autonomous navigation with colregs, using velocity obstacles. *IEEE Journal of Oceanic Engineering*, 39(1):110–119.
- LaValle, S.
 2006. *Planning algorithms*. Cambridge university press.
- Lee, T., H. Kim, H. Chung, Y. Bang, and H. Myung
 2015. Energy efficient path planning for a marine surface vehicle considering heading angle. *Ocean Engineering*, 107:118–131.
- Lefeber, E., K. Y. Pettersen, and H. Nijmeijer
 2003. Tracking control of an underactuated ship. *IEEE transactions on control systems technology*, 11(1):52–61.
- Liu, Y. and R. Bucknall
 2015. Path planning algorithm for unmanned surface vehicle formations in a practical maritime environment. *Ocean Engineering*, 97:126–144.
- Liu, Y., W. Liu, R. Song, and R. Bucknall
 2017. Predictive navigation of unmanned surface vehicles in a dynamic maritime environment when using the fast marching method. *International Journal of Adaptive Control and Signal Processing*, 31(4):464–488.
- Loe, G.
 2008. Collision avoidance for unmanned surface vehicles.
- Massey, J. P.
 2006. *Control and waypoint navigation of an autonomous ground vehicle*. PhD thesis, Texas A&M University.
- Mohanty, P. and D. Parhi
 2013. Controlling the motion of an autonomous mobile robot using various techniques: a review. *Journal of Advance Mechanical Engineering*, 1(1):24–39.
- Mooney, P., P. Corcoran, and A. Winstanley
 2010. Towards quality metrics for openstreetmap. In *Proceedings of the 18th SIGSPATIAL international conference on advances in geographic information systems*, Pp. 514–517. ACM.
- Naeem, W., G. Irwin, and A. Yang
 2012. Colregs-based collision avoidance strategies for unmanned surface vehicles. *Mechatronics*, 22(6):669 – 678.
- Nash, A., K. Daniel, S. Koenig, and A. Felner
 2007. Theta^{*}: Any-angle path planning on grids. In *AAAI*, Pp. 1177–1183.
- Petres, C., Y. Pailhas, P. Patron, Y. Petillot, J. Evans, and D. Lane
 2007. Path planning for autonomous underwater vehicles. *IEEE Transactions on Robotics*, 23(2):331–341.
- Rabin, S.
 2000. A* speed optimizations. *Game Programming Gems*, 1:272–287.
- Roberts, G.
 2008. Trends in marine control systems. *Annual reviews in control*, 32(2):263–269.
- Șerban, A.
 2016. Time optimal trajectory generation from polyline with velocity, acceleration and spatial deviation constraints. In *IOP Conference Series: Materials Science and Engineering*, volume 147, P. 012104. IOP Publishing.
- Shah, B.
 2016. *Planning for Autonomous Operation of Unmanned Surface Vehicles*. PhD thesis, University of Maryland, College Park.
- Sharma, S., W. Naeem, and R. Sutton
 2012. An autopilot based on a local control network design for an unmanned surface vehicle. *The Journal of Navigation*, 65(2):281–301.

- Sharma, S. K., R. Sutton, A. Motwani, and A. Annamalai
 2014. Non-linear control algorithms for an unmanned surface vehicle. *Proceedings of the Institution of mechanical engineers, Part M: Journal of Engineering for the Maritime Environment*, 228(2):146–155.
- Singh, Y., S. Sharma, D. Hatton, and R. Sutton
 2016. Optimal path planning of unmanned surface vehicles. *Indian Journal of Geo-Marine Science*, In Press.
- Singh, Y., S. Sharma, R. Sutton, and D. Hatton
 2017a. Optimal path planning of an unmanned surface vehicle in a real-time marine environment using dijkstra algorithm. In *Marine Navigation and Safety of Sea Transportation*, P. 399402. CRC Press.
- Singh, Y., S. Sharma, R. Sutton, and D. Hatton
 2017b. Path planning of an autonomous surface vehicle based on artificial potential fields in a real time marine environment. In *Computer Applications and Information Technology in the Maritime Industries. COMPIT 2017. Proceedings of the 16th International Conference on*, Pp. 48–54. Cardiff.
- Soullignac, M.
 2011. Feasible and optimal path planning in strong current fields. *IEEE Transactions on Robotics*, 27(1):89–98.
- Statheros, T., G. Howells, and K. Maier
 2008. Autonomous ship collision avoidance navigation concepts, technologies and techniques. *The Journal of Navigation*, 61(1):129–142.
- Stentz, A.
 1994. Optimal and efficient path planning for partially-known environments. In *Robotics and Automation, 1994. Proceedings., 1994 IEEE International Conference on*, Pp. 3310–3317. IEEE.
- Svec, P., M. Schwartz, A. Thakur, and S. Gupta
 2011. Trajectory planning with look-ahead for unmanned sea surface vehicles to handle environmental disturbances. In *2011 IEEE/RSJ International Conference on Intelligent Robots and Systems*, Pp. 1154–1159.
- Svec, P., B. Shah, I. Bertaska, J. Alvarez, A. Sinisterra, K. Von Ellenrieder, M. Dhanak, and S. Gupta
 2013. Dynamics-aware target following for an autonomous surface vehicle operating under colregs in civilian traffic. In *Intelligent Robots and Systems (IROS), 2013 IEEE/RSJ International Conference on*, Pp. 3871–3878. IEEE.
- Tam, C., R. Bucknall, and A. Greig
 2009. Review of collision avoidance and path planning methods for ships in close range encounters. *The Journal of Navigation*, 62(3):455–476.
- UK, M.
 2017. The maritime autonomous surface ships code of practice.
- Warren, C.
 1990. A technique for autonomous underwater vehicle route planning. *IEEE Journal of Oceanic Engineering*, 15(3):199–204.
- Yang, J., C. Tseng, and C. Fan
 2012. Collision-free path planning for unmanned surface vehicle by using advanced A* algorithm. In *26th Asian-Pacific Technical Exchange and Advisory Meeting on Marine Structure*, Pp. 251–256.
- Zeng, Z., K. Sammut, A. Lammas, F. He, and Y. Tang
 2015. Efficient path re-planning for AUVs operating in spatiotemporal currents. *Journal of Intelligent & Robotic Systems*, 79(1):135.
- Zeng, Z., K. Sammut, L. Lian, F. He, A. Lammas, and Y. Tang
 2016. A comparison of optimization techniques for AUV path planning in environments with ocean currents. *Robot. Auton. Syst.*, 82(C):61–72.