

2017

A QoE-driven Vertical Handover Management Framework for Multimedia Services over Wireless Networks

Liu, Li

<http://hdl.handle.net/10026.1/10042>

<http://dx.doi.org/10.24382/708>

University of Plymouth

All content in PEARL is protected by copyright law. Author manuscripts are made available in accordance with publisher policies. Please cite only the published version using the details provided on the item record or document. In the absence of an open licence (e.g. Creative Commons), permissions for further reuse of content should be sought from the publisher or author.

PLYMOUTH UNIVERSITY

**A QoE-driven Vertical Handover
Management Framework for Multimedia
Services over Wireless Networks**

By

Li Liu

Ph.D.

September 2017

Copyright©2017 Li Liu

This copy of the thesis has been supplied on condition that anyone who consults it is understood to recognise that its copyright rests with its author and that no quotation from the thesis and no information derived from it may be published without the author's prior consent.



**A QoE-driven Vertical Handover
Management Framework for Multimedia
Services over Wireless Networks**

by

Li Liu

A thesis submitted to Plymouth University in partial fulfilment for the degree of

DOCTOR OF PHILOSOPHY

School of Computing, Electronics and Mathematics

Faculty of Science and Engineering

September 2017

A QoE-driven Vertical Handover Management Framework for Multimedia Services over Wireless Networks

Li Liu

Abstract

With advances in wireless technology and mobile devices, the number of mobile users using multimedia services has increased significantly in recent years. Mobile devices can be connected and roam on heterogeneous wireless networks. The IEEE 802.21 group has designed a Media Independent Handover (MIH) standard to ensure seamless Vertical Handover (VHO) in heterogeneous networks. However, the standard currently depends on features of the network (e.g. the type of network and available bandwidth) to achieve seamless VHO. This approach is limited, as it does not consider how a Quality of Experience (QoE) can be provided and maintained for customers when delivering multimedia services in heterogeneous wireless networks.

The aim of the project is to develop a novel QoE-driven VHO management framework for providing and maintaining an appropriate level of QoE of multimedia services as the mobile user's actual requirements in heterogeneous wireless networks. A QoE-driven VHO algorithm is more efficient for maintaining this acceptable QoE of multimedia services than traditional network-based or QoS-based VHO algorithms.

There are three main contributions during this project. Firstly, A thorough evaluation of the performance of voice and video services via Skype was carried out in terms of the QoE metric (i.e. MOS). This work identified the impact of video content and packet loss on the

QoE metric for voice and video communication services over wireless networks. Secondly, a QoE-driven VHO algorithm was developed to provide and maintain an acceptable QoE of mobile video services for mobile users. Compared to a traditional network-based VHO algorithm, this algorithm can provide better QoE and maintain acceptable QoE. Lastly, the User-centric QoE-driven (UCQoE) VHO framework to provide satisfactory QoE of multimedia services according to the mobile user's requirements. The framework allows users to set their own preferences (e.g. quality-guarantee or cost-free) and carry out VHO operations accordingly. The evaluation showed that the proposed framework can provide a better QoE for delivered video services than QoS-based and network-based VHO algorithms. Furthermore, the proposed framework can be used to avoid unnecessary cost of mobile data when the option of cost-free is preferred by the user.

During this project, three international conference papers had been published and a journal paper has been submitted to IEEE Transactions on Mobile Computing. The main contribution-UCQoE VHO management framework can be developed to maintain QoE of all mobile services in the future.

Acknowledgements

This long journey throughout my PhD has been a fantastic and unforgettable part of my life. Much help and support has enabled this journey to come to an end. First, I would like to express my appreciation to my supervisor Dr. Lingfen Sun for her patience; her professional guidance; her inspiration; her motivation throughout this project; and the tremendous amount of time and effort she spent to ensure the high quality of my sections and this thesis. Moreover, I am especially appreciative of her support and encouragement during the period in which I was upset and the confidence she gave me to bravely press on through and continue the journey until the end. Additionally, I would also like to thank my second supervisor Prof. Emmanuel Ifeakor for his professional guidance, constructive criticism, time, and effort in supporting my research during this journey.

I would also like to thank my colleagues Dr. Is-Haka Mkwawa and Dr. Emmanuel Jammeh for their help, support and constructive discussions throughout this project. They gave me many professional suggestions on how to implement the experiments and simulations, and were a brilliant inspiration for the design of my work.

I would also like to thank my parents, Zhongping Liu and Meili Jiang, for their unmeasurable love and support; as well as my wife, Huilan Chen, and our children for their endless love, support and encouragement. Without them, I could not have been able to complete this PhD project successfully.

Declaration

At no time during the registration for the degree of Doctor of Philosophy has the author been registered for any other University award without prior agreement of Graduate Sub-Committee.

Work submitted for this research degree at Plymouth University has not formed part of any other degree, either at Plymouth University or at another establishment.

Publications:

The original work presented in this thesis has been published in the following International Conferences:

- **L Liu**, L Sun, E Ifeachor and I Mkwawa. “*Congestion Control Algorithm and Performance Analysis of Voice and Video Call over Skype*”. Collaborative European Research Conference (CERC), 17th and 18th October 2013, Cork, Ireland.
- **L Liu**, L Sun, and E Ifeachor. “*A QoE-driven Vertical Handover Algorithm based on media independent handover framework.*” Wireless and Mobile Computing, Networking and Communications (WiMob), 2015 IEEE 11th International Conference on. IEEE, 19th to 21st October 2015, Abu Dhabi, UAE.
- **L Liu**, L Sun, and E Ifeachor. “*User-centric QoE-driven Vertical Handover Framework in Heterogeneous Wireless Networks.*” Wireless and Mobile Computing, Networking and Communications (WiMob), 2016 IEEE 12th International Conference on. IEEE, 17th to 19th October 2016, New York, USA.

A journal paper “User-centric QoE-driven Vertical Handover Framework for Video Services in Heterogeneous Networks” to be submitted to IEEE Transactions on Mobile Computing.

Word-count of main body of thesis: 41631 words

Signed:

Li Liu

Date: 27th September 2017

Table of Contents

Abstract.....	I
Acknowledgements.....	III
Declaration.....	IV
Table of Contents.....	VI
List of Figures.....	X
List of Tables.....	XIV
List of Abbreviations and Glossary.....	XV
Chapter 1: Introduction.....	1
1.1. Motivations of Study.....	2
1.2. Research Questions.....	5
1.3. Project Aims and Objectives.....	7
1.4. Contributions of this Thesis.....	8
1.5. Outline of the Thesis.....	9
Chapter 2: Literature Review on Mobility Management.....	12
2.1. Introduction.....	12
2.2. Mobility Management Protocols.....	13
2.2.1. Mobile IPv4 (MIPv4).....	15
2.2.2. Mobile IPv6 (MIPv6).....	17
2.2.3. Fast Mobile IPv6 (FMIPv6).....	19
2.2.4. Hierarchy Mobile IPv6 (HMIPv6).....	21

2.2.5.	Proxy Mobile IPv6 (PMIPv6).....	22
2.2.6.	Comparison of IP Mobility Management Protocols	26
2.3.	Media Independent Handover Standard.....	28
2.4.	Vertical Handover Algorithms.....	34
2.4.1.	Phases of Vertical Handover.....	34
2.4.2.	Network-centric Vertical Handover Algorithms	39
2.4.3.	User-centric Vertical Handover Algorithms	42
2.4.4.	Multi-criteria-centric Vertical Handover Algorithms.....	43
2.4.5.	QoE-driven Vertical Handover Algorithms.....	48
2.4.6.	Comparison of Vertical Handover Algorithms.....	53
2.5.	Summary	54
Chapter 3: QoE Evaluation of Voice and Video Call Services over WiFi		56
3.1.	Introduction.....	56
3.2.	Related Work	57
3.3.	Experimental Testbed Setup	58
3.4.	Performance Evaluation of Skype Voice Calls.....	60
3.4.1.	QoS Analysis of Skype Voice Calls	60
3.4.2.	QoE Analysis of Skype Voice Calls	64
3.5.	Performance Evaluation of Skype Video Calls	65
3.5.1.	QoS Analysis of Skype Video Calls	65
3.5.2.	QoE Analysis of Skype Video Calls.....	74

3.6.	Summary	75
Chapter 4: QoE-driven Vertical Handover Algorithm.....		77
4.1.	Introduction.....	77
4.2.	QoE Prediction Model	77
4.3.	QoE-driven Vertical Handover Algorithm	79
4.4.	Performance Evaluation.....	83
4.4.1.	Simulation Design and Topology	83
4.4.2.	Results Analysis.....	86
4.5.	Summary	92
Chapter 5: User-centric QoE-driven Vertical Handover Management Framework		94
5.1.	Introduction.....	94
5.2.	Basic UCQoE VHO Management Framework.....	95
5.3.	Performance Evaluation of Basic UCQoE VHO Management Framework.....	99
5.3.1.	Simulation Setup.....	99
5.3.2.	Results Analysis.....	102
5.3.3.	Summary	113
5.4.	Advanced UCQoE VHO Management Framework	114
5.5.	Performance Evaluation of Advanced UCQoE VHO Management Framework ..	123
5.5.1.	Simulation Setup.....	123
5.5.2.	Results Analysis.....	125
5.5.3.	Summary	135

5.6.	Financial Impacts	135
5.7.	Summary	138
Chapter 6: Conclusions and Future Work.....		140
6.1.	Introduction.....	140
6.2.	Contributions to Knowledge	141
6.3.	Limitations of Current Work	143
6.4.	Suggestions for Future Work.....	144
6.5.	Conclusions.....	146
References.....		148

List of Figures

Figure 1.1: Outline of thesis.....	11
Figure 2.1: The scenario of heterogeneous wireless network [10]	13
Figure 2.2: Process flow of Mobile IPv4	16
Figure 2.3: Process flow of Mobile IPv6	18
Figure 2.4: Binding establishment procedures of MIPv6	18
Figure 2.5: The Handover procedures of FMIPv6.....	20
Figure 2.6: Basic structure of Hierarchical MIPv6.....	22
Figure 2.7: Basic topology of PMIPv6	24
Figure 2.8: Signalling flow of Initial attachment and handover procedure in PMIPv6.....	25
Figure 2.9: Media Independent Handover (MIH) [33]	29
Figure 2.10: General Architecture of IEEE 802.21 [32].....	31
Figure 2.11: Example of VHO between 3G and WiFi [32].....	32
Figure 2.12: Basic structure of handover processes.....	35
Figure 2.13: Horizontal handover and vertical handover [9].....	37
Figure 2.14: Zahran et al.'s VHO Algorithm [38].....	41
Figure 2.15: Different factors in relation to QoE [81]	48
Figure 3.1: Testbed for Skype voice/video call	59

Figure 3.2: Payload sizes under different packet loss rates	61
Figure 3.3: Interarrival times under different packet loss rates	62
Figure 3.4: Throughputs under different packet loss rates	64
Figure 3.5: Payload size of Skype video calls under different packet loss rates	66
Figure 3.6: Interarrival time of Skype video call under different packet loss rates	68
Figure 3.7: Throughput of Skype video calls under different packet loss rates	69
Figure 3.8: Payload size of Skype video calls under different available bandwidth	70
Figure 3.9: Interarrival time of Skype video calls under different available bandwidth	71
Figure 3.10: Throughput of Skype video call under different available bandwidth	74
Figure 3.11: Average MOS of Skype video calls under different packet loss rates	75
Figure 4.1: Process flows of the QoE-driven VHO algorithm.....	82
Figure 4.2: Simulation Topology	84
Figure 4.3: Average PER of SM video	86
Figure 4.4: Average PER of RM video.....	88
Figure 4.5: QoE performance of SM video	89
Figure 4.6: QoE performance of RM video	90
Figure 5.1: Structure of basic UCQoE VHO management framework	95
Figure 5.2: Process flows of basic UCQoE VHO management framework.....	97
Figure 5.3: Simulation Topology	100

Figure 5.4: MOS of SM video over WiFi network with 4% packet loss.....	103
Figure 5.5: MOS of GW video over WiFi network with 4% packet loss.....	105
Figure 5.6: MOS of RM video over WiFi network with 4% packet loss	105
Figure 5.7: MOS of SM video over WiFi network with 6% packet loss.....	107
Figure 5.8: MOS of GW video over WiFi network with 6% packet loss.....	108
Figure 5.9: MOS of RM video over WiFi network with 6% packet loss	109
Figure 5.10: Overall MOS of SM video under different packet loss rate.....	110
Figure 5.11: Overall MOS of GW video under different packet loss rate.....	111
Figure 5.12: Overall MOS of RM video under different packet loss rate	112
Figure 5.13: Structure of advanced UCQoE VHO management framework	119
Figure 5.14: Process flow of QoE-driven VHO algorithms management.....	121
Figure 5.15: The topology of simulation	124
Figure 5.16: MOS of SM video over WiFi network with 4% packet loss.....	126
Figure 5.17: MOS of GW video over WiFi network with 4% packet loss.....	127
Figure 5.18: MOS of RM video over WiFi network with 4% packet loss	128
Figure 5.19: MOS of SM video over WiFi network with 6% packet loss.....	129
Figure 5.20: MOS of GW video over WiFi network with 6% packet loss.....	130
Figure 5.21: MOS of RM video over WiFi network with 6% packet loss	131
Figure 5.22: Overall MOS of SM video over WiFi network.....	132

Figure 5.23: Overall MOS of GW video over WiFi network 133

Figure 5.24: Overall MOS of RM video over WiFi network 134

Figure 5.25: Overall QoE performance and mobile proportions of mobile network connection time of SM video under diverse packet loss rates..... 136

Figure 5.26: Overall QoE performance and proportions of mobile network connection time of GW video under diverse packet loss rates 137

Figure 5.27: Overall QoE performance and proportions of mobile network connection time of RM video under diverse packet loss rates..... 138

List of Tables

Table 2.1: The characters of different radio access technologies [7, 11, 12]	14
Table 2.2: The specific addresses and prefix	23
Table 2.3: The features of network layer mobility management protocols	27
Table 2.4: Different types of collected information.....	36
Table 2.5: Features of existing QoE-driven VHO algorithms	52
Table 3.1: The average MOS of Skype voice call under different packet loss rates	65
Table 4.1: Coefficient metrics of all types of video.....	78
Table 4.2: Pseudocodes of the QoE-driven VHO algorithm	82
Table 4.3: Simulation Parameters	86
Table 4.4: Average MOS of overall SM and RM Video	92
Table 5.1: Simulation Parameters	101
Table 5.2: Parameters of mobile video service and wireless networks	125

List of Abbreviations and Glossary

3G	Third Generation
4G	Fourth Generation
AAA	Authentication, Authorization and Accounting
AHP	Analytic Hierarchy Process
AP	Access Point
BAck	Binding Acknowledgement
BCE	Binding Cache Entry
BER	Bit Error Ratio
BL	Block List
BU	Binding Update
BS	Base Station
CIR	Carrier to Interference Ratio
CN	Correspondent Node
CoA	Care-of-Address
CoT	Care-of Test
CoTI	Care-of Test Init
CPU	Central Processing Unit

FA	Foreign Agent
FBack	Fast Binding Acknowledge
FBU	Fast Binding Update
FEC	Forward Error Correction
FMIPv6	Fast Mobile Internet Protocol Version 6
FNA	Fast Neighbour Advertisement
FR	Frame Rate
GRA	Grey Relational Analysis
GRC	Grey Relational Coefficient
GSM	Global System for Mobile Communication
GW	General Walking
HA	Home Agent
HAck	Handover Acknowledge
HI	Handover Initiate
HIP	Host Identity Protocol
HoA	Home Address
HoT	Home Test
HoTI	Home Test Init
HMIPv6	Hierarchical Mobile Internet Protocol Version 6

IETF	Internet Engineering Task Force
IPv4	Internet Protocol Version 4
IPv6	Internet Protocol Version 6
LCoA	On-link Care-of Address
LMA	Local Mobility Anchor
LMAA	Local Mobility Anchor Address
LTE	Long-Term Evolution
MAD	Multiple Attribute Decision
MAG	Mobility Access Gateway
MANN	Multiple Artificial Neural Network
MAP	Mobility Anchor Point
MCT	Minimum Connecting Time
MEW	Multiplicative Exponent Weighting
MICS	Media Independent Command Service
MIES	Media Independent Event Service
MIIS	Media Independent Information Service
MIH	Media Independent Handover
MIHF	Media Independent Handover function
MIPv4	Mobile Internet Protocol Version 4

MIPv6	Mobile Internet Protocol Version 6
MN	Mobile Node
MN-Identifier	Mobile Node Identifier
MN-HNP	Mobile Node's Home Network Prefix
MN-HoA	Mobile Node's Home Address
MOS	Mean Opinion Score
MRT	Minimal Remaining Time
MT	Mobile Terminal
NAR	New Access Router
NEWT	Network Emulator for Windows Toolkit
NS	Network Simulator
NSR	Noise Signal Ratio
PAR	Previous Access Router
PBA	Proxy Binding Acknowledgement
PBU	Proxy Binding Update
PER	Packet Error Rate
Proxy-CoA	Proxy Care-of Address
PMIPv6	Proxy Mobile Internet Protocol Version 6
PrRtAdv	Proxy Router Advertisement

PoA	Point of Attachment
PoS	Point of Service
PSQA	Pseudo-Subjective Quality Assessment
QoE	Quality of Experience
QoS	Quality of Service
RA	Radio Advertisement
RCoA	Regional Care-of Address
RM	Rapid Movement
RNC	Radio Network Controller
RSS	Received Signal Strength
RtSolPr	Router Solicitation for Proxy Advertisement
SAW	Simple Additive Weighting
SAP	Service Access Point
SBR	Sender Bitrate
SIR	Signal to Interference Ratio
SIP	Session Initiation Protocol
SM	Slow Movement
SP	Service Provider
TCP	Transmission Control Protocol

TOPSIS	Technique for Order Preference by Similarity to Ideal Solution
UCQoE	User-centric QoE-driven
UMTS	Universal Mobile Telecommunication System
VHO	Vertical Handover
WiMAX	Worldwide Interoperability for Microwave Access
WLAN	Wireless Local Area Network

Chapter 1: Introduction

In recent years, with the dramatic development of wireless access technologies and mobile video services, the number of mobile users with access to a mobile video service across multiple wireless access networks has increased exponentially. People use mobile phones for services as video conferencing (e.g. Skype), video streaming (e.g. YouTube and Netflix), and social networks (e.g. Facebook and Snapchat). It is estimated that mobile video services will dominate mobile services over future Internet [1-3]. Furthermore, mobile users and service providers are concerned about Quality of Experience (QoE) for multimedia services delivered over wireless networks more than ever before. There are many different wireless networks, such as cellular mobile networks (e.g. 3G and 4G networks) and Wireless LAN (WLAN) or WiFi networks. To achieve seamless connection to the Internet anytime and anywhere, and implement vertical handover (VHO) between heterogeneous wireless networks (e.g. from WiFi to 4G) while delivering multimedia services, smooth and efficient mobility management or VHO are the key challenges. These include how to select an appropriate candidate wireless network and when to initiate a vertical handover (VHO) between heterogeneous wireless networks to satisfy mobile users' requirements on QoE of delivered multimedia services. Existing one-size-fits-all VHO approaches are not able to satisfy mobile users' requirements on QoE of video services over heterogeneous wireless networks. Due to these increasing pressures, a one-size-fits-all VHO algorithm is not enough to satisfy the requirements of mobile users on the QoE of video services over heterogeneous wireless networks, which is the dilemma this project seeks to address.

This chapter will introduce the motives behind this project that led to three fundamental research questions. Moreover, the aims, objectives and contributions of this project will be presented. This chapter is arranged as follows: Section 1.1 will introduce the motivations

behind this project. The research questions are presented in Section 1.2. Section 1.3 will present the aims and objectives of this project. After discussing the aims and objectives, Section 1.4 will summarise the main contributions of this study. Following these sections, Section 1.5 will present the overview and implications of this thesis.

1.1. Motivations of Study

Currently, there are many different forms of wireless access technologies for mobile users to choose from, such as: third generation (3G) mobile network; Universal Mobile Telecommunication System (UMTS); fourth generation (4G) mobile network; Long-Term Evolution (LTE); Worldwide Interoperability for Microwave Access (WiMAX) and Wireless Local Area Network (WLAN). Even fifth generation (5G) network is under designing and investigating. In light of these different alternatives, a heterogeneous wireless network consists of different wireless access technologies, such as WLAN, UMTS and LTE. Each wireless access technology has its advantages and disadvantages. For example, while UMTS and LTE has a larger signal coverage than that of WLAN; WLAN has a higher speed than UMTS and LTE. Furthermore, WLAN is cheaper than the UMTS and LTE networks. Because of these differences, as any single wireless access technology is unable to provide any service, anywhere and at any time; it is necessary to take advantage of all wireless access technologies for optimum service delivery. In instances where mobile devices can roam and switch between different wireless networks, this is called vertical handover (VHO) and enables the device to access any service irrespective of time and location and over any wireless network.

Recent reports showed that 48% of the total IP traffic data was wireless traffic data, which for mobile devices in 2015 included 6% of data over mobile networks and 8% of data from WiFi networks[2]. Furthermore, the data share from wireless traffic is predicted to rise to 67% for

mobile devices in 2020; in which 17% will be mobile data and 29% will be from WiFi sources. Among different mobile services, mobile video services dominated data traffic in mobile networks and represented more than half of the global mobile data traffic in 2012. Building on this trend, mobile video services are forecasted to account for 78% of mobile data by 2021[1-3]. Because of this growing data share, mobile video services have become a lifestyle norm for users who favour consuming video content at any time and location, such as live streaming and making video calls. Furthermore, more and more mobile users are concerned about the Quality of Experience (QoE) that represents the customer's experience with a given service. As a method of quantifying this, the Mean Opinion Score (MOS) is the metric most widely used to represent QoE: MOS ranges from 1 to 5, and represents QoE from bad to excellent. The QoE of mobile video services is the personal perception among users of video services consumed based on a mobile device.

As different mobile users have a different set of criteria for mobile video services, different individuals may have a different QoE with the same mobile video services and under the same network conditions. Furthermore, even the same individual may have different QoE requirements with the same mobile video services under same network conditions depending on the time at which the content is consumed. For example, when both WiFi and 4G networks are available, some people might prefer to use WiFi networks due to its free cost, whereas others might prefer to use whatever network providing the best quality without any concerns on the cost issue. A user's preferences on utilizing a wireless network might also change due to different circumstances. In addition to this variability, there are many factors which could affect the QoE of mobile video services, such as network conditions; the capacity of the mobile device; the parameters of the video; the contents in the video; the cost of data; and even the mood of the mobile user. In acknowledging these factors, QoE must affect the number of users selecting a mobile video service from a mobile service provider

(SP), and the customer's satisfaction rate for a services and further customer retention rate are also key to the success of SPs. Because of this, the importance of QoE for the provisioning for these services has been increasingly recognised by SPs. One example of this acknowledgment is where video services such as Skype request feedback on the user's QoE following every voice and video call. By implementing feedback on QoE obtained by each user is therefore able to help Skype enhance QoE for delivered services and thus achieve competitive advantage against other similar SPs. Because of this, it is necessary that mobile video services are provided and maintained with good QoE at any location and at any time over any wireless network.

When combining the influence of heterogeneous wireless networks and a mobile video service, a VHO function becomes important for providing and maintaining good QoE of mobile video services in this heterogeneous wireless network environment. The VHO function allows mobile devices to switch between different wireless networks when connecting to a mobile video server. However, the method of choosing a candidate network and deciding when to initiate the VHO operation while still maintaining a positive QoE for mobile video services, still remains an open question. In the VHO function, a VHO algorithm is responsible for selecting a target network from candidate networks and making a handover decision to initiate a VHO operation. If the VHO algorithm targets a network with poor network condition, it would make it impossible to provide and maintain a positive QoE of mobile video services for the mobile user. Furthermore, some mobile users may have requirements or preferences related to the cost of data consumption that a VHO algorithm would need to consider. When a mobile user would like to use free wireless network access without being concerning about the impact on QoE of a mobile video service, the mobile user would not happy if the VHO algorithm prioritised a wireless network that incurred a charge. Additionally, the initiation time of the VHO also affects the QoE of mobile video services. If

the VHO algorithm initiated the VHO too early or too late, the QoE of the mobile video service would be degraded as a result. Due to this factor, a VHO algorithm should be able to provide and maintain the QoE of mobile video services according to the individual expectations and preferences of the mobile user. As a mobile user may have different criteria for a positive QoE of mobile video services, the VHO framework needs to be designed such that it is able to maintain or enhance the QoE for mobile video services when delivered over heterogeneous wireless networks, but while also taking into account the user's requirements/preferences for mobile services at the same time.

1.2. Research Questions

This thesis seeks to address the following three significant research questions:

Q1) What are the relationships between the QoE of mobile video services and network/application related parameters?

This led to a significant research investigating the relationships between the QoE of mobile video services, the network impairments (e.g. packet loss) and type of video content: a fundamental investigation into the relationships between the QoE of mobile video services and network impairments was conducted. A mobile video service with the same video content is evaluated under a WiFi network at different levels of network impairment. Here, the MOS scores of the mobile video services are obtained from subjective tests. Furthermore, the impact the type of video content has on QoE is investigated using different formats of video content over a WiFi network under diverse packet loss rates. This work will be discussed in Chapter 3.

Q2) How should VHO algorithms be developed to maintain QoE of mobile video services?

Currently, most existing VHO algorithms use Quality of Service (QoS) parameters (i.e. packet loss) as the criteria for making a handover decision: this current implementation may not be able to provide and maintain the QoE of the mobile video service, as QoS is not directly linked with a user's perceived quality of the service or QoE. Moreover, unnecessary VHO also leads to additional power consumption and strain on the device's central processing unit (CPU). Because of this dilemma, this led to a fundamental investigation into how to derive a VHO algorithm with appropriate criteria that would be able to directly reflect QoE of mobile video services with different type of video content. Firstly, a VHO algorithm using the appropriate criteria could make a correct handover decision that provides and maintains QoE of mobile video services. Secondly, a VHO algorithm with appropriate criteria also could prevent VHO from being triggered unnecessarily, and therefore save power and CPU consumption. This work will be discussed in Chapter 4.

Q3) How should VHO algorithms be developed to maintain the QoE of mobile video services?

Different customers have different needs/preferences for mobile services. A one-size-fits-all approach is not suitable for modern mobile services as mobile users today may have different requirements on mobile video services at different time. Moreover, any single VHO algorithm is unable to satisfy the mobile user consistently. Further, this study raises two questions:

1. How can we acquire the mobile user's actual requirements at different times? This question was approached by classifying the criteria of the mobile users' requirements, and then creating a function to obtain the actual requirements from the mobile user.
2. How can we satisfy these differing and changing criteria of the mobile user for QoE of mobile video services? This question was addressed by finding a method of

cooperating different VHO algorithms to satisfy the requirements of the mobile users as they changed.

If the two fundamental questions are able to be solved, this means that it would be possible to satisfy mobile users with a changing set of criteria according to different times. As different customers have different requirements/preferences for mobile services, a one-size-fits-all approach is not suitable for modern mobile/telecom services. Therefore, facilitating a variety of choice for mobile users is key for SPs to maintain their competitive advantage. In response to this, this study proposes a User-centric QoE-driven VHO framework to provide a solution for answering this question. This framework will consider the following requirement levels of the mobile users: prime quality, acceptable quality and cost-free. This work will be discussed in Chapter 5.

1.3. Project Aims and Objectives

The main aims of this project are: first, to investigate the relationships between the QoE metric of mobile video, network impairments and types of video content; second, to design a QoE-driven VHO algorithm with appropriate criteria for providing and maintaining QoE of mobile video service with different types of video content, and to avoid VHO being triggered unnecessarily to the detriment of the device's performance; third, to design a user-centric QoE-driven VHO management framework which is able to acquire the actual requirements of mobile users and satisfy mobile users with different requirements at different times.

The specific objectives of this research are to:

1. Undertake a fundamental investigation to understand and identify the impact of network impairments (e.g. packet loss) and the type of the video content on the QoE of mobile video services.

2. Identify appropriate criteria for developing a VHO algorithm that is able to effectively provide and maintain QoE of mobile video services for mobile users. Furthermore, this algorithm also needs to consider video content type and avoid unnecessary VHO.
3. Develop a generic VHO management framework which can take into account users' different requirements and preferences on the consumption of mobile video services, and at the same time maintain a satisfactory QoE for delivered multimedia services.

1.4. Contributions of this Thesis

The three main contributions of the thesis are as following:

1. The performance of the Skype video service was evaluated under a WiFi network with different network impairments and with different types of video content. A detailed understanding of the relationship between the QoE of mobile video services, the network impairment and the type of video content was carried out. Because of these findings, these results could help identify a set of appropriate criteria for the VHO algorithm to use in order to provide and maintain QoE of mobile video services. (The associated publication is [4]).
2. A QoE-driven VHO algorithm was developed based on maintaining an acceptable QoE ($MOS > 3.5$) as the criterion. This algorithm could efficiently provide and maintain an acceptable QoE of mobile video services using different types of video content and under heterogeneous wireless networks. Furthermore, this algorithm could also be used to avoid unnecessary VHO and data cost for the end user. (The associated publication is [5]).
3. A user-centric QoE-driven (UCQoE) VHO management framework was designed to maintain QoE of mobile video services based on the actual requirements of the mobile user. In the UCQoE VHO management framework, the requirements are defined

based on whether mobile users prefer to maintain QoE of the mobile video services or whether they prioritise ensuring free WiFi network connectivity. Additionally, several VHO algorithms are also applied in the UCQoE VHO management framework to make the handover decision based on individual requirements of the mobile user.

(The associated publication is [6]).

1.5. Outline of the Thesis

As outlined in Fig. 1.1 below, the structure of this thesis is described as follows:

In order to understand the state-of-art of mobility management for multimedia services in heterogeneous wireless networks, Chapter 2 reviews the comprehensive background knowledge on mobility management and the vertical handover algorithms used in heterogeneous wireless networks; with Section 2.2 presenting the background of mobility management protocols within a heterogeneous wireless network, and with Section 2.3 introducing the MIH standard. Furthermore, to summarise the chapter, Section 2.4. and Section 2.5 present a comprehensive overview of the existing vertical handover algorithms.

To design a VHO algorithm to effectively maintain the QoE of multimedia services when subject to heterogeneous wireless networks, it is necessary to understand the different features of multimedia services and the influences that impact them when delivered over a wireless network. To further this understanding, Chapter 3 investigates the relationship between the network parameters, the video parameters and the resulting QoE of the mobile video service. In this chapter, Section 3.2 will introduce related research on the existing QoE recovery methods used in the Skype platform; the experiment testbed will be depicted in Section 3.3; Section 3.4 and 3.5 will present an evaluation of the performance of Skype voice calls and video calls; and Section 3.6 will summarise the chapter.

As the investigations of Chapter 2 and Chapter 3 demonstrate that it is possible to design a VHO algorithm to maintain the QoE of video services over heterogeneous wireless networks, Chapter 4 moves on to introduce a QoE-driven VHO algorithm. In this chapter, the reference-free QoE prediction model applied to the QoE-driven VHO algorithm is introduced in Section 4.2, and Section 4.3 then presents the details of the QoE-driven VHO algorithm. Following these sections, a performance evaluation of the QoE-driven VHO algorithm will be discussed in Section 4.4, followed lastly by Section 4.5 to summarise the chapter.

Furthermore, as the mobile user may have different requirements for the QoE of video services in different situations, a one-size-fits-all QoE-driven VHO algorithm is insufficient for ensuring user satisfaction at all times. In response to this, Chapter 5 proposes a user-centric QoE-driven (UCQoE) vertical handover (VHO) management framework. Moreover, the structure and performance evaluation of the basic UCQoE VHO management framework will be presented in Section 5.2 and 5.3. Moreover, the advanced UCQoE VHO management framework will be introduced in Section 5.4. Then, Section 5.5 will present the performance evaluation of the advanced UCQoE VHO management framework. Financial impacts of UCQoE VHO management framework will be discussed in Section 5.6. After covering these sections, this chapter will be concluded in Section 5.7.

Following these chapters, Chapter 6 reviews the achievements of this project, summarises the thesis and makes suggestions for future research.

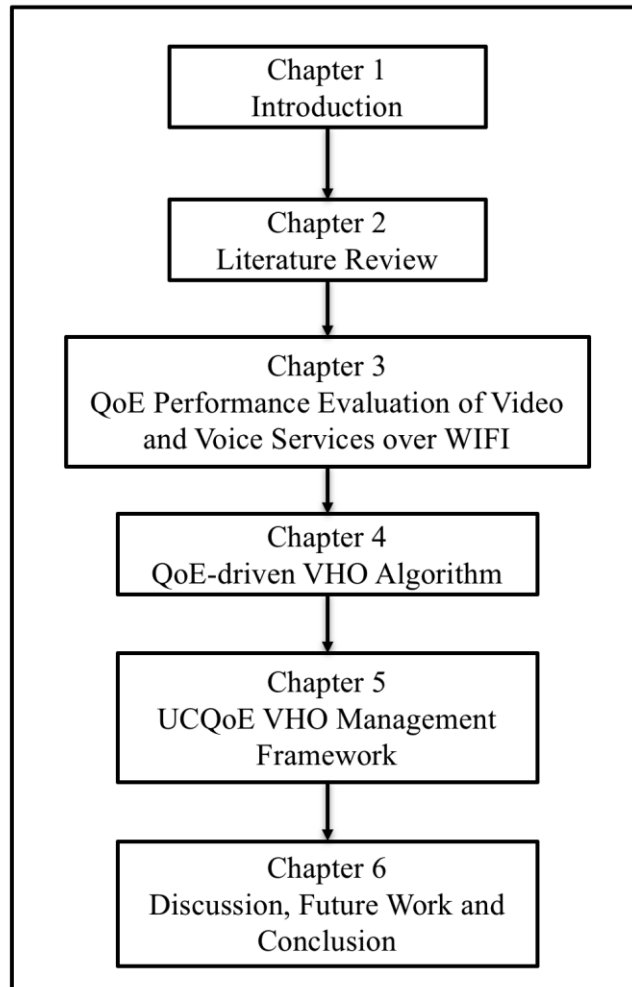

Figure 0.1: Outline of thesis

Chapter 2: Literature Review on Mobility Management

2.1. Introduction

In recent years, more and more mobile users have used mobile video services over a heterogeneous wireless network. This all-IP-based heterogeneous wireless network comprises of different network access technologies such as Wireless Local Area Network (WLAN), Worldwide Interoperability for Microwave Access (WIMAX), Global System for Mobile Communication (GSM) and Long Term Evolution (LTE) [7, 8]. Furthermore, as not any single wireless network is able to provide consistent mobile service access anywhere and at any time, it is therefore necessary for devices to take advantage of multiple different network access technologies and switch their network connection from one network access technology to another: this process of switching is called Vertical Handover (VHO). Among mobile services, mobile video services dominate the network traffic in wireless networks, but are yet more susceptible to degrading network conditions than most types of mobile services [9]. Moreover, as QoE is becoming more and more important to mobile users, how to achieve seamless VHO among different wireless networks and at same time maintain QoE for delivered mobile video services remain key challenges for mobility management in heterogeneous wireless networks.

Overall, the aim of this literature review is to present the background of mobility management and VHO in heterogeneous wireless networks. In this chapter, Section 2.2 presents the background of mobility management protocols in a heterogeneous wireless network. Following this section, Section 2.3 introduces the Media Independent Handover (MIH) standard; and Section 2.4 then presents a comprehensive review of vertical handover algorithms. Lastly, a summary of this chapter is presented in Section 2.5.

2.2. Mobility Management Protocols

In recent times, wireless networks have been made accessible everywhere and smart mobile devices are now able to connect to multiple wireless networks. Within these modern network environments, all wireless networks comprise of heterogeneous wireless networks and an example of this scenario is illustrated below in Fig. 2.1. Additionally, the concept behind the heterogeneous wireless network is that mobile users are able to use any mobile service irrespective of location and time of access.

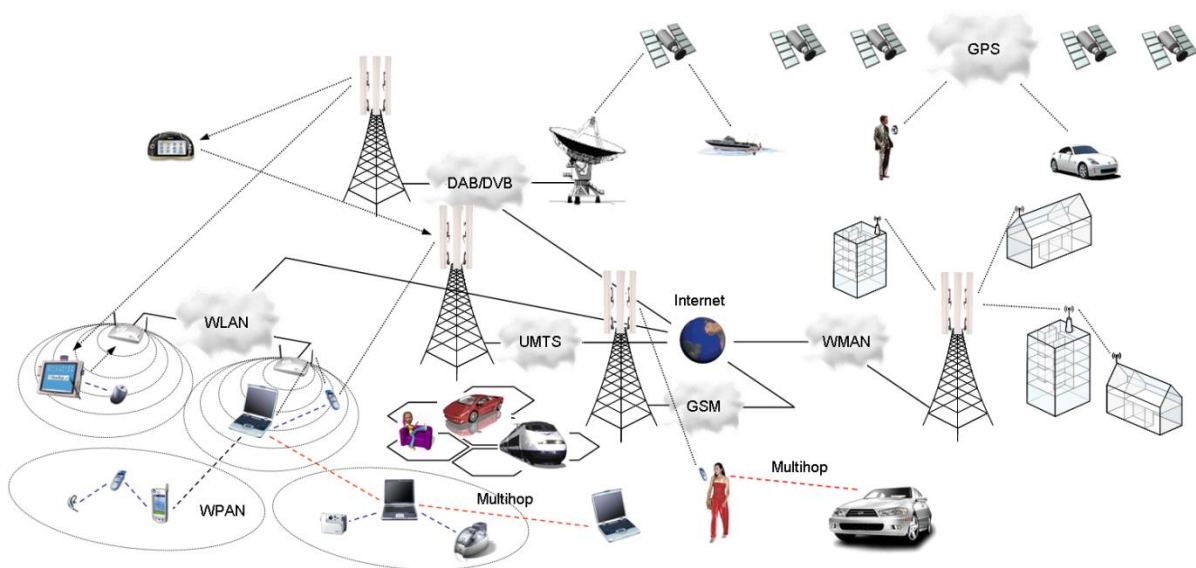

Figure 0.1: The scenario of heterogeneous wireless network [10]

Furthermore, as each different network access technology holds different characteristics, being able to fully take advantage of different network access technologies presents the potential of delivering services to mobile users at any time or location. Within a heterogeneous network, the main characteristics include the scope of signal coverage area, the data transmission rate capacity, the support of mobility/handover and the cost of implementation. Moreover, the main characteristics of existing popular network access technologies are summarised in Table 2.1 below:

Table 2.1: The characters of different radio access technologies [7, 11, 12]

Technologies	Coverage area	Maximum Downlink Rate	Mobility/Handover Support	Cost
Bluetooth	10 m – 100 m	2.1 Mbit/s	Nomadic, Handover not supported	Low
WiFi (IEEE 802.11 family)	20 m – 50 m indoors Up to 250 m outdoors	802.11b: 11 Mbit/s 802.11a/g: 54 Mbit/s 802.11n: up to 248 Mbit/s	Nomadic, Mobility with in the AP's range, Proprietary solutions: thin Aps under control of AC, 802.11r supports mobility and handover	Medium
Global System for Mobile Communication (GSM)	Up to 30 km	Up to 236.8 Kbit/s	High mobility, Handover supported	Medium
UMTS	5 km	HSPA: 14.4 Mbit/s HSPA+: 47 Mbit/s	High mobility, Handover supported	Medium
WIMAX (IEEE 802.16 family)	5 km, up to 30 km	802.16d: 9.4 Mbit/s 802.16e: 46 Mbit/s Expected up to 1 Gbit/s in 802.16m	Nomadic, Handover not supported in fixed WIMAX (IEEE 802.16d), Seamless handover in mobile WIMAX (IEEE 802.16e)	High
LTE	5 km	144 Mbit/s Expected up to 1 Gbit/s in LTE-advanced	High mobility, Handover supported	High
Satellite	World	144 kbit/s	High mobility	High

For achieving this desired outcome in a heterogeneous wireless network, mobility management is key to converging the different network access technologies. Mobility management consists of location management and handover management [13]. Location management concerns tracking the current position of mobile terminals (MTs) via location updates and paging. Handover management enables MT to maintain its connection when changing its attaching access points (APs). Furthermore, depending on the locations of the

previous attaching AP and the new AP, the mobility of the MT can be defined as micro-mobility and macro-mobility. When a MT moves between two subnets in the same domain, this movement is called micro-mobility. Conversely, when a MT moves from one domain to another domain, this movement is called macro-mobility. However, controlling and managing the data flows of the connection effectively throughout mobility procedures is the key determinant for achieving seamless handover. There are several protocols designed to transport packets over globe internet by using Internet Protocol Version 4 (IPv4) and Internet Protocol Version 6 (IPv6) such as Mobile IPv4 (MIPv4), Mobile IPv6 (MIPv6) and the variants of Mobile IPv6 [14]. Furthermore, depending on what facilitates the mobility management, these protocols could be classified as two types: host-based and network-based protocols. The traditional protocols such as Mobile IPv4 and Mobile IPv6 are host-based protocols that the MTs will use to initiate and manage the handover execution procedures. Additionally, some variants of Mobile IPv6, such as Fast Mobile IPv6 (FMIPv6) and Hierarchical Mobile IPv6 (HMIPv6), are the host-based protocols. Proxy Mobile IPv6 (PMIPv6), a new variant of Mobile IPv6, is designed to provide network-based mobility management for MT. In this section, the following the IP-based mobility management protocols will be introduced: Mobile IPv4, Mobile IPv6, FMIPv6, HMIPv6 and PMIPv6.

2.2.1. Mobile IPv4 (MIPv4)

The Mobile IPv4 is designed by Internet Engineering Task Force (IETF) to support the roaming of MT across network domains and to redirect the packets to the new location for MT [15]. There are four types of functional entities in the architecture of MIPv4: Mobile Node (MN), Home Agent (HA), Foreign Agent (FA) and Correspondent Node (CN). HA is the router in MN's home network, which maintains the information of MNs current location and channels the data to MN when the MN distant from the home network. Furthermore, FA is the router in MN's visited network that channels the data for the MN as the MN is

registered by the FA. CN represents the server which provides the services to MN. To achieve data delivery, two different types of addresses are assigned to MN by MIPv4: The Home Address (HoA) and the Care-of-Address (CoA). HoA permanently represents the MN's home network. CoA represents the MN's current visited network that will change with MN roaming from one visited network to another. In the MIPv4, when the MN roams from one network to another network, CN does not need to know the MN's mobility. CN simply sends all packets to HA, and then HA redirects the packets to the MN through the updated CoA as illustrated below in Fig. 2.2.

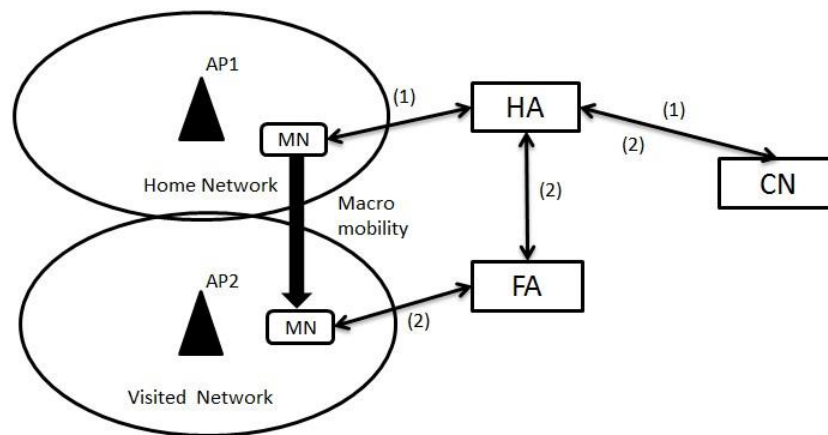

Figure 0.2: Process flow of Mobile IPv4

When MN remains in its home network, HA sends the packets from CN to MN via a pathway (1). When MN moves into the visited area, MN registers itself in the FA by exchanging messages of solicitation or advertisement. After this stage, it then obtains a CoA from FA and this CoA is then sent to HA to update the current location of the MN. Through this process, this establishes the new pathway (2) between MN and CN. In turn, the data from CN to MN will be redirected to FA by HA based on the CoA. Then, following this step, the data is then channelled to MN by FA.

However, while MIPv4 supports the mobility for MN, the triangular routing problem still presents several clear drawbacks. Firstly, the data exchanged between CN and MN is

required to be sent through HA, which significantly places an unnecessary burden on HA and results in delay of delivery. Secondly, when MN moves from an old FA to a new FA, no exchange of information occurs between the old FA and the new FA. Due to this, when MN disconnects from the old FA and connect to the new FA, the packet that has been tunnelled to the old FA is lost as a result. Thirdly, the delay of signal could become very significant and change dramatically as the distance between FA and HA increases. To address the dilemmas in MIPv4 and implement IPv6, the Mobile IPv6 is designed to facilitate a more efficient mobility management for MN.

2.2.2. Mobile IPv6 (MIPv6)

Furthermore, Mobile IPv6 is also developed by IETF, and this enables MN to achieve the global mobility in IPv6 [16]. However, when compared to MIPv4, MIPv6 contains no FA. With the absence of the FA, MIPv6 enables the MN to move outside the home network without any special support required from the local router. Furthermore, MIPv6 supports route optimisation as a fundamental part that can securely operate without pre-arranged security associations. Additionally, as MIPv6 uses an IPv6 routing header to send packets to MN when MN is outside of the home network, this could reduce the amount of resulting overhead. Below, the basic topology of MIPv6 is outlined in Fig. 2.3. When MN remains in the home network, HA is responsible for tunnelling the packets to MN based on MN's HoA through path (1). As MN moves to a visited network and obtains a new CoA, MN then sends its CoA to HA so that HA can forward the packets to MN based the CoA through path (2). Furthermore, a route optimisation operation is also applied by MIPv6 to address the triangular problem: this route optimisation operation, called binding, enables the MN to create a direct and secure route to CN through correspondent registration procedure. Using this process, all packets between MN and CN can be transported through the route without tunnelling of HA. Furthermore, in order to assess the legitimacy of MN, the return routability

procedure should be completed between MN and CN as a part of the correspondent registration procedure.

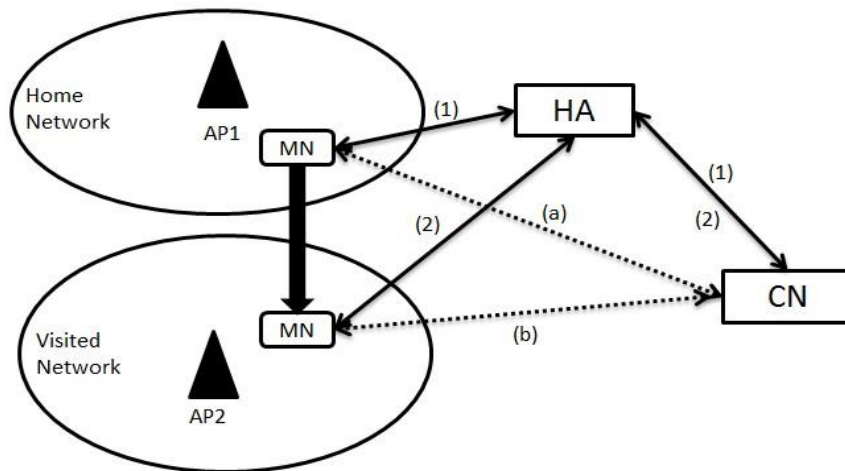

Figure 0.3: Process flow of Mobile IPv6

Moreover, between MN and CN during the return routability procedure, four messages are exchanged: The Home Test Init (HoTI), the Care-of Test Init (CoTI), the Home Test (HoT) and the Care-of Test (CoT). To illustrate this assessment, the basic procedures of binding establishment are in Fig. 2.4 below:

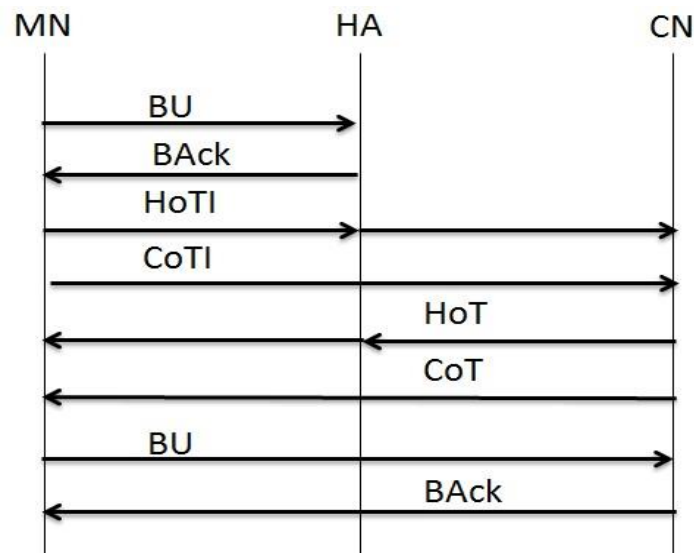

Figure 0.4: Binding establishment procedures of MIPv6

Through this procedure, the HoTI message and CoTI message are sent from CN to MN at the same time. However, the HoTI message should be sent to CN through HA, and the CoTI message should be sent to CN directly. In this case, once CN receives the HoTI and CoTI

messages, the HoT and CoT messages would be returned quickly. In turn, after the return routability procedure, MN can then send the Binding Update (BU) message to CN and wait for the Binding Acknowledgement (BAck) message from CN. Once MN receives the Back message, the binding between MN and CN is established.

However, although MIPv6 supports IPv6 mobility and can provide more dependable mobility than MIPv4, there are still some drawbacks such as high handover latency, high packet loss and signalling overheads. Furthermore, as MIPv6 treats global mobility the same as local mobility, consideration is given to the local network as MIPv6 is in global mobility. Due to these factors, MIPv6 still needs to be improved to enhance its mobility further. Moreover, some variants of MIPv6 have been proposed to improve the performance of MIPv6: these include Fast Mobile IPv6 and Hierarchy Mobile IPv6 [17].

2.2.3. Fast Mobile IPv6 (FMIPv6)

For this alternative, Fast Mobile IPv6 is a platform based on MIPv6 that aims to reduce handover latency and minimise service disruption throughout the MIPv6 handover procedure [18, 19]. With FMIPv6, MN can anticipate the handover process it is able to send a Router Solicitation for Proxy Advertisement (RtSolPr) and sends a message to inform the previous access router (PAR) of the potential handover, and then requests the new CoA used with the new access router (NAR). Furthermore, once the PAR receives the RtSolPr message, it replies with a Proxy Router Advertisement (PrRtAdv) message that includes the new CoA and information about the neighbouring AR. Furthermore, this PrRtAdv message also constitutes the trigger to initiate the handover process. MN instructs PAR to redirect its packets to NAR by sending the Fast Binding Update (FBU) message to PAR. After this, the PAR will then deliver the Handover Initiate (HI) message to NAR which aims to assess the uniqueness of the new CoA for MN, and build a temporary tunnel between PAR and NAR to forward the packets for MN. In the event that the tunnel is successfully established and that

the new CoA of MN is confirmed as unique, NAR then replies with the Handover Acknowledge (HACK) message to PAR. In turn, once PAR receives the Hack message, it then sends Fast Binding Acknowledge (FBack) messages to MN through the PAR and NAR access link as responses for the FBU message, and begins to forward the packets to NAR for MN. Subsequently, once MN receives the FBack message, it immediately initiates handover to NAR. Conversely, if MN does not receive the FBack message, it delivers a Fast Neighbour Advertisement (FNA) to NAR to confirm its attachment. Furthermore, when NAR receives the packets for MN tunnelled by PAR, the packets are buffered until the MN becomes attached to NAR, with those buffered packets then forwarded to MN. After MN handover to NAR, it also updates the binding with CN using the same procedure as with MIPv6. These basic handover procedures in FMIPv6 are shown in Fig. 2.5.

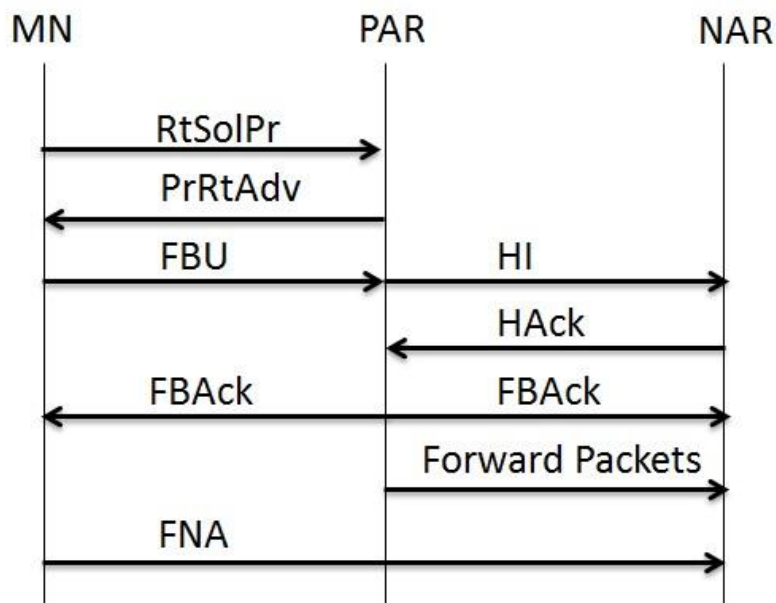

Figure 0.5: The Handover procedures of FMIPv6

Overall, to effectively reduce the delay and packet loss during the handover procedure, FMIPv6 applies a reliable handover prediction whereby PAR completes the predictive configuration for MN before MN initiates handover to NAR. However, while FMIPv6 does have the potential for improving the quality of MIPv6, there are still several limitations.

Additionally, one of the most significant factors is whether the period of time for triggering the pre-configuration for MN is appropriate [20]. Moreover, if the pre-configuration is triggered too early or too late, this results in a packet loss causing the quality of mobility to degrade dramatically.

2.2.4. Hierarchy Mobile IPv6 (HMIPv6)

As another proposition to improve local mobility, Hierarchy Mobile IPv6 (HMIPv6) is also suggested and based on the MIPv6 [21]. With HMIPv6, a new function router called Mobility Anchor Point (MAP) is designed to act as a local HA for HMIPv6-aware MNs that can receive and process the MAP options, and then send local binding updates to MAP. Furthermore, when a HMIPv6-aware MN moves into a MAP domain, it receives Router Advertisements that contain the information about the local MAP. Furthermore, Regional Care-of Address (RCoA) is automatically configured by MN, which is an address on the MAP's subnet. However, CoA, which is the address of current position in MIPv6, is mentioned as a On-link Care-of Address (LCoA) to distinguish it from RCoA. Additionally, HMIPv6-aware MN can bind its LCoA with RCoA so that MAP is able to receive all packets for HMIPv6-aware MN and then forward the packets to the MN based on its LCoA. When a HMIPv6-aware MN moves from one subnet to another within same MAP domain, the HMIPv6-aware MN only needs to register a new LCoA with MAP. Moreover, the RCoA does not need to be changed providing that the HMIPv6-aware MN remains in the MAP domain. In this case, the local mobility in one MAP domain is transparent to HA and CN, which means that HA and CN will send all packets to MAP until the MN leaves the MAP domain. Furthermore, MAP will buffer the packets until MN attaches to a new subnet in its domain. In using this process, this could significantly reduce the packet loss. To demonstrate this process, the basic structure of HMIPv6 is shown below in Fig 2.6.

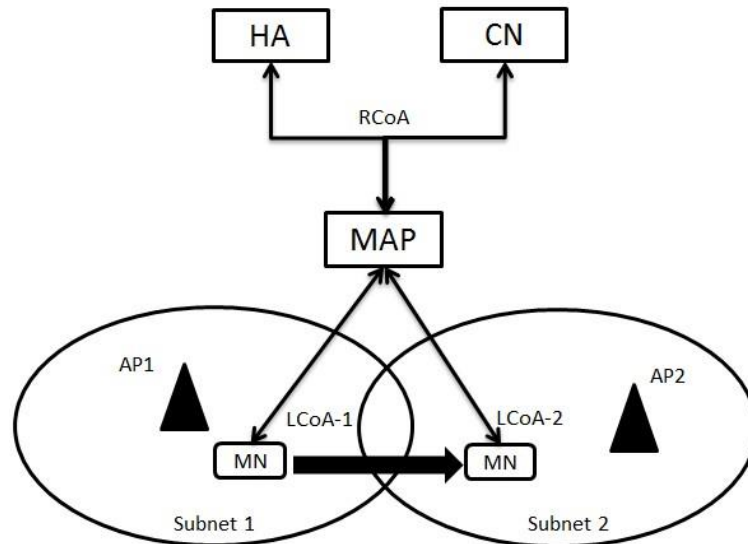

Figure 0.6: Basic structure of Hierarchical MIPv6

By using this structure, the HMIPv6 could significantly reduce the handover latency and signalling overheads in the local mobility of MIPv6 by using MAP as a local HA for MN. Nevertheless, it is better that FMIPv6 is implemented for local domain communication. In order to address this scenario, a combination of HMIPv6 and FMIPv6, called F-HMIPv6, has been proposed to enhance the performance of MIPv6 [22]. However, as FMIPv6 and HMIPv6 are host-based mobility management protocols, the complexity of MN is increased as a result. This means that the MNs not only need modifying for protocol stack, but should also be able to fulfil the required. In addition to this added complexity, some issues in MIPv6 remain in the host-based protocols: these include high handover latency, high packet loss and signalling overhead.

2.2.5. Proxy Mobile IPv6 (PMIPv6)

With this solution, Proxy Mobile IPv6 (PMIPv6) is a network-based protocol that supports the mobility for IPv4 and IPv6 without the involvement of MN [23]. Additionally, the development of PMIPv6 is based on MIPv6 and reuses the functionality of HA that uses the messages format of mobility signalling. Here, there are two new functional entities: Local Mobility Anchor (LMA) and Mobility Access Gateway (MAG). The LMA acts as the HA in

MIPv6 for MN in the Proxy Mobile IPv6 Domain (PMIPv6-Domain) such that it manages the binding state of MN, and uses the functional capabilities of HA developed in MIPv6, but with additional capabilities that are required to support PMIPv6. Furthermore, MAG is a functional access router that can manage the mobility-related signalling for attached MNs. Furthermore, MAG is also able to track the movement of the attached MN and perform the mobility management on behalf of the MNs. As listed in Table 2.2, there are some specific addresses and prefixes that PMIPv6 defines:

Table 2.2: The specific addresses and prefix

Address/Prefix	Description
LMA Address (LMAA)	LMA Address (LMAA) is configured by LMA representing the transport endpoint of the bidirectional tunnel between LMA and MAG.
Proxy Care-of Address (Proxy-CoA)	Proxy Care-of Address (Proxy-CoA) is configured by MAG referred as the endpoint of the bidirectional tunnel between LMA and MAG.
Mobile Node's Home Network Prefix (MN-HNP)	Mobile Node's Home Network Prefix (MN-HNP) is a prefix representing the link between MN and MAG.
Mobile Node's Home Address (MN-HoA)	MN-HoA is an address from MN's MN-HNP which is configured on MN's interface.

Since LMAA and Proxy-CoA represent LMA and MAG separately, as the endpoint of the bidirectional tunnel between LMA and MAG; MAG is able to send the Proxy Binding update message to LMA based on LMAA through the bidirectional tunnel. Furthermore, it should also be mentioned that HM-HNP could be assigned to the link and all HM-HNP are able to be managed as a part of the mobility session. When MN connects to MAG through multiple interfaces, each of the interfaces are assigned a unique set of HM-HNP. However, only the prefixes assigned to one interface will be managed within one mobility session. Furthermore, the mobility entities in PMIPv6 would only be aware of MN-HNP of MN, and not aware of MN-HoA of MN during the mobility session. To illustrate this relationship, the basic structure of PMIPv6 is shown below in Fig. 2.7.

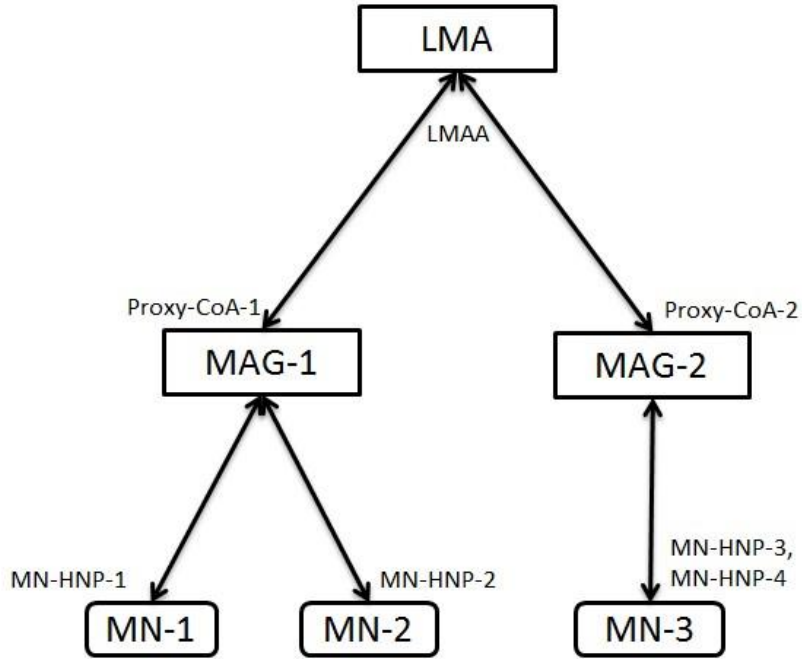

Figure 0.7: Basic topology of PMIPv6

In PMIPv6, there are two main phases: The phase of Initial Attachment and the phase of Handover Procedure [23]. The signalling flow of these two phases are illustrated in Fig. 2.8. As MN moves into a PMIPv6 domain, it delivers its Mobile Node Identifier (MN-Identifier) to MAG-1 to initiate the attachment. After this occurs, MAG-1 then sends an Authentication, Authorization and Accounting (AAA) request message to the AAA server. Accordingly, once the MN is confirmed as legitimate, the AAA server then replies with an AAA response message to MAG-1. Once MAG-1 receives the AAA response message, it sends a Proxy Binding Update (PBU) message to LMA to update the location of MN on MN's behalf. Furthermore, after LMA receives the PBU message from MAG-1, it creates a Binding Cache Entry (BCE) that binds the MN-HNP to the MAG-1 address, and then replays the Proxy Binding Acknowledgement (PBA) message to MAG-1. After this process is completed, the bidirectional tunnel is established between MAG-1 and LMA. As a result, the data exchange between MN and CN is transported through LMA and MAG-1.

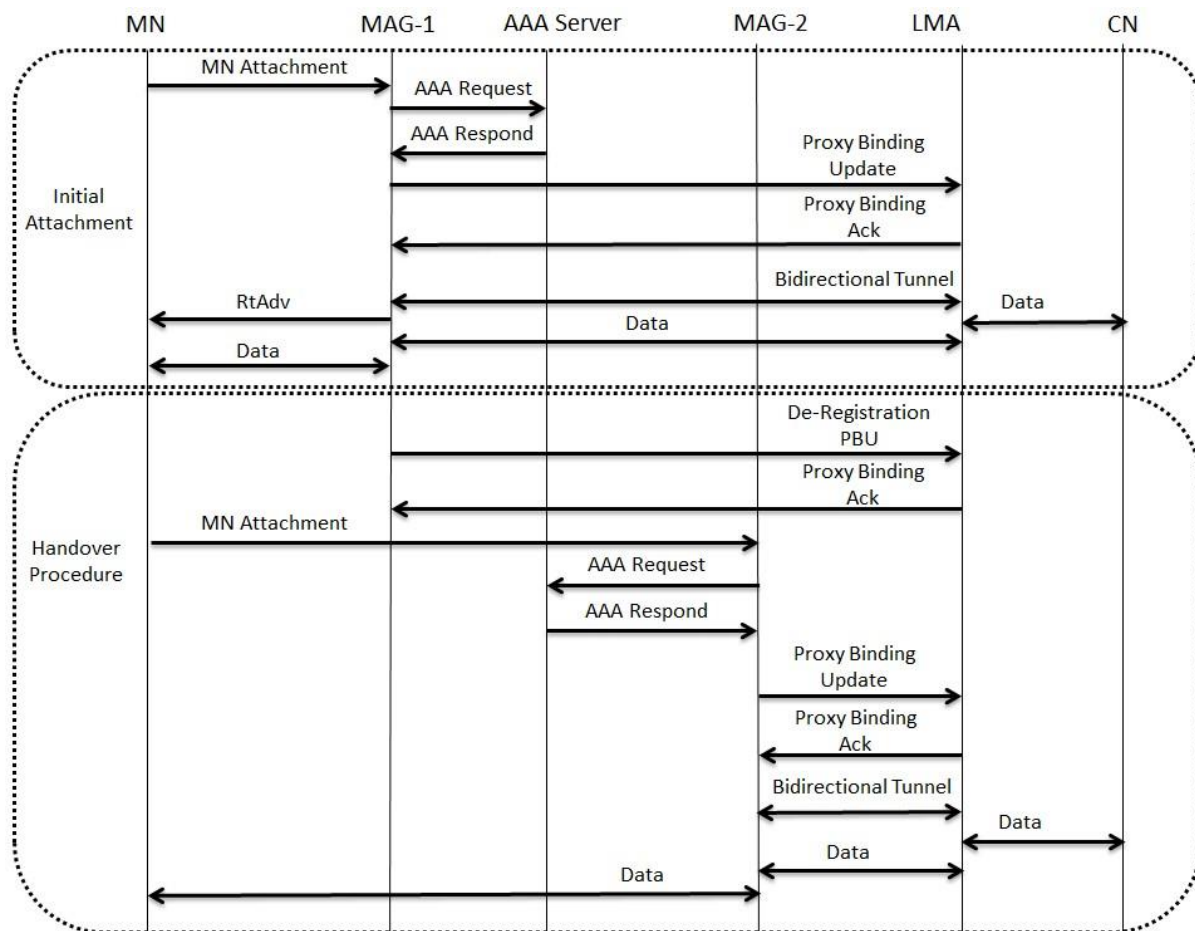

Figure 0.8: Signalling flow of Initial attachment and handover procedure in PMIPv6

Furthermore, as MAG-1 is able to track the movement of MN, when MAG-1 detects that MN is moving to MAG-2, it responds by sending a De-registration PBU message to LMA. After LMA receives the De-registration PBU message, it then replies with a PBA message to MAG-1 and waits for the amount of time it takes for the BCE for MN to be deleted. Once this has occurred, as MN attaches; MAG-2, MAG-2 then assesses the legitimacy of MN with the AAA server and register MN with its address on LMA to create a bidirectional tunnel for MN just as in the Initial attachment phase. Lastly, at the end of the handover procedure, the data between MN and CN is then transported via LMA and MAG-2.

Overall, PMIPv6 is a localized mobility protocol that applies MAG to perform mobility management for MN. Furthermore, the detection of movement is accomplished by MAG in

the link layer. Additionally, PMIPv6 supports IPv4 and IPv6 at same time. Due to these factors, PMIPv6 could reduce the handover latency and signalling overhead. However, in spite of these advantages, PMIPv6 still needs to be improved to avoid the interruption in communication that occurs at the link layer handover, and support the QoS of real-time services and multimedia applications [24, 25]. Moreover, as PMIPv6 is a localised mobility management protocol, it still needs to interact with MIPv6 to support global mobility for MNs.

2.2.6. Comparison of IP Mobility Management Protocols

In the above subsections, the basic network layer mobility management protocols have been reviewed. Overall, the above protocols could be categorised as either host-based mobility management protocols or network-based mobility management protocols. In Table 2.3 below, the features of those network layer mobility management protocols are outlined:

When compared against host-based MIPv6 protocols, the signalling update-time could be shortened and there is no high requirement for MN in PMIPv6. Furthermore, PMIPv6 is the only protocol that able to support IPv4 and IPv6 simultaneously. Furthermore, many studies have conducted experiments to the compare the performance of different network layer protocols. In one study, Lee et al compared MIPv6, FMIPv6, HMIPv6, PMIPv6 and FPMIPv6 in terms of their handover latency, handover blocking probability and the amount of packet loss [26]. As a result of this study, it was demonstrated that FMIPv6 and FPMIPv6 are more effective than other protocols for controlling handover latency, handover blocking probability and packet loss. Moreover, the author summarised the main factors impacting the handover latency, handover blocking probability and packet loss as being: the link layer information, the condition of the wireless link, the duplicate address detection latency and the topology of the network.

Table 2.3: The features of network layer mobility management protocols

Characteristics	Mobile IPv4	Mobile IPv6	Fast Mobile IPv6	Hierarchical Mobile IPv6	Proxy Mobile IPv6
Mobility Management Type	Host-based	Host-based	Host-based	Host-based	Network-based
Mobility Scope	Global	Global	Local or Global	Local	Local
Handover Movement	Support (partial)	Support (partial)	Support	Support	Support
Location Management	Support	Support	NO	Support	Support
Handover Category	Reactive	Reactive	Reactive and proactive	Reactive	Reactive
Supported IP Version	IPv4	IPv6	IPv6	IPv6	IPv4 and IPv6
Transmission Approach	Address mapping	Binding cache	Binding Cache	Binding Cache	Proxy Binding Cache
Required Entities	HA and FA	HA	HA and enhanced AR	HA and MAP	LMA and MAG
MN's Address	HoA and CoA	HoA and CoA	HoA and CoA	HoA and CoA	HNP
Binding Cache Key	HoA and CoA	HoA and CoA	HoA and CoA	HoA and CoA	MN-ID and HNP
MN Modifications	Yes	Yes	Yes	Yes	No
Multi-homing Support	No	No	No	No	Yes
Router Advertisement	Broadcast	Broadcast	Broadcast	Broadcast	Unicast
Buffer Support	No	No	Yes	Yes	Yes

Conversely, Singh and Singh compared MIPv6, FMIPv6, HMIPv6 and F-HMIPv6 in terms of handover latency and packet loss [19]. From this study, the results showed that F-HMIPv6 was better able to control the handover latency and packet loss when compared against other protocols. As a means to qualify this, Makaya and Pierre proposed a comprehensive analytical model for IPv6-based mobility management protocols, such as MIPv6, FMIPv6, HMIPv6 and F-HMIPv6: this model encompassed the factors of signalling overhead cost; the cost of packet loss, the cost of binding refresh; the total signalling cost; the required buffer

space; handover latency; and packet loss expression [27]. As another means of qualifying this effect, KiSik et al compared PMIPv6 with MIPv6 and HMIPv6 in terms of three impacts: wireless link delay; delay between MN and CN; and the delay in movement detection [28]. Here, the results showed that PMIPv6 outperformed MIPv6 and HMIPv6 in most scenarios. Overall PMIPv6, on this basis, could significantly improve the performance of MIPv6. Additionally, PMIPv6 outperformed FMIPv6 and HMIPv6 in most scenarios. However, the performance of PMIPv6 also needs to be improved and PMIPv6 should be able to cooperate with other mobility management protocols to support an increasing movement towards global mobility in the future. In the next section, a standard will be reviewed that is able to provide seamless VHO across heterogeneous wireless networks.

2.3. Media Independent Handover Standard

The Media Independent Handover (MIH) standard, which is proposed by the IEEE 802.21 group, is designed to facilitate seamless handover in a heterogeneous wireless network. The MIH standard provides a framework that allows high layers (e.g. layer 3 and above) to interact with low layers (layer 2 and below) without considering the specifics of each network type. At the core of MIH is the MIH function (MIHF), which provides three forms of services that enable seamless handover to occur: The Media Independent Event Service (MIES), Media Independent Information Service (MIIS) and Media Independent Command Service (MICS) [29-32]. Furthermore, it is also required that the upper layers register as MIH for information between the upper layers (e.g. network layer) and lower layers (e.g. link layer and physic layer) to be transported effectively. The structure of MIH is illustrated below in Fig. 2.9.

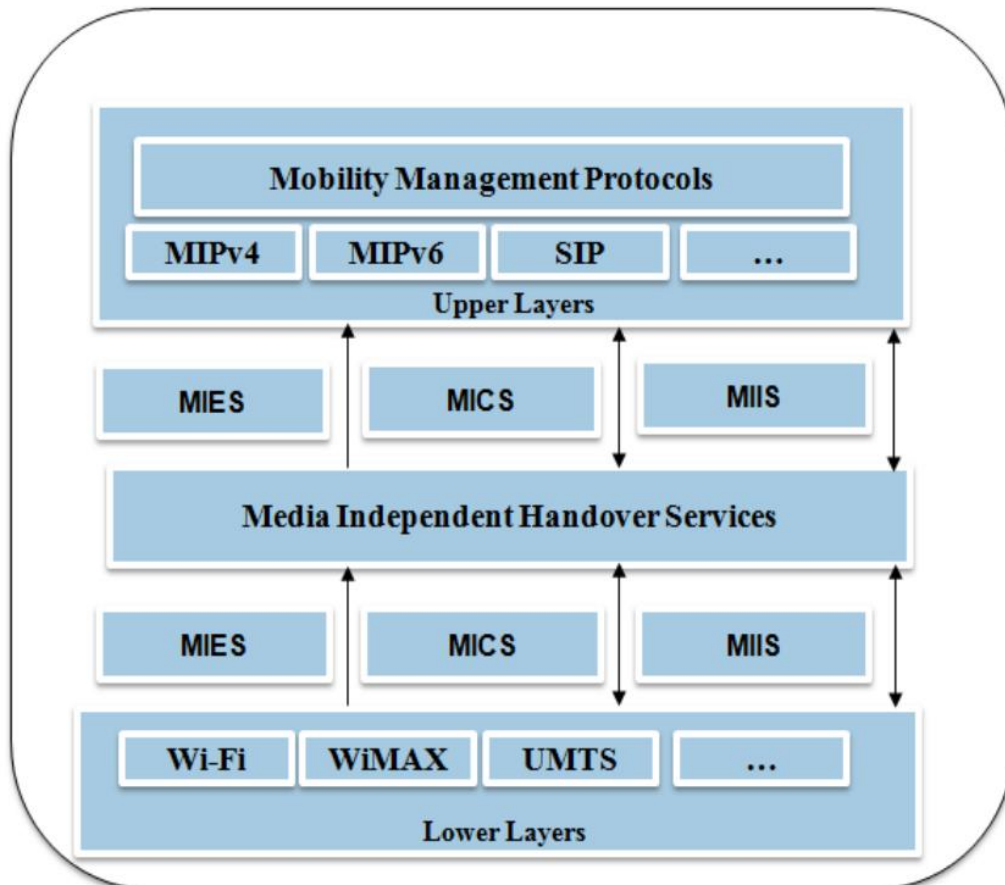

Figure 0.9: Media Independent Handover (MIH) [33]

Overall, the responsibilities of MIES, MIIS and MICS are listed below:

- **MIES**, which presents information of a significant event: these can be events of state change, predictive events and network initiated events; all initiated after detecting changes in the physical layer and link layer (e.g. link up, link down and link going down etc.).
- **MIIS**, which is responsible for gathering information about neighbouring networks (e.g. network types and capabilities): this is used by the vertical handover algorithm to make a handover decision.
- **MICS**, which provides essential commands for MIH users to control and accomplish the handover functions such as handover initiation, preparation, execution and completion.

In the IEEE 802.21, there is an important media-independent entity that has been defined, which is the media-independent service access point (SAP). SAP aims to handle the specifics of each type of network that collect information and control the link behaviour as handover occurs. Moreover, SAPs can be classified as either media-independent or media-specific: MIH_SAP, MIH_LINK_SAP and MIH_NET_SAP.

- **MIH_SAP**, which is a media-independent SAP. MIH_SAP provides an interface that allows upper layers to control and monitor different links regardless of the network type.
- **MIH_LINK_SAP**, which is a media-specific SAP. MIH_LINK_SAP provides an interface that enables MIHF to control and monitor media-specific links.
- **MIH_NET_SAP**, which is a media-dependent SAP. MIH_NET_SAP is used to provide a data transport service on the local node and exchange MIH information and messages with the remote MIHF.

In using this categorisation, the general architecture of IEEE 802.21 comprises of MIH users: MIHF, MIH_SAP, MIH_LINK_SAP and MIH_NET_SAP. These entities provide functions and services that support seamless vertical handover between different networks for mobile device users that could be used to subsequently enhance both the experience of mobile users and the capability of mobile devices. To demonstrate this, the general architecture of IEEE 802.21 is outlined below in Fig. 2.10. MN possesses two network interfaces that allow MN to connect two different networks: the 3GPP/3GPP2 and 802 group networks. Moreover, the MIHF and MIH users, and the SAPs are implemented in each device to support VHO. Here, there are two important entities defined by IEEE 802.21: Point of Attachment (PoA) and Point of Service (PoS).

- **Point of Attachment (PoA)**, which is defined as an endpoint of a Layer 2 link that includes MN as the other endpoint.

- **Point of Service (PoS)**, which is defined as a network entity that can exchange MIH messages and information using MN.

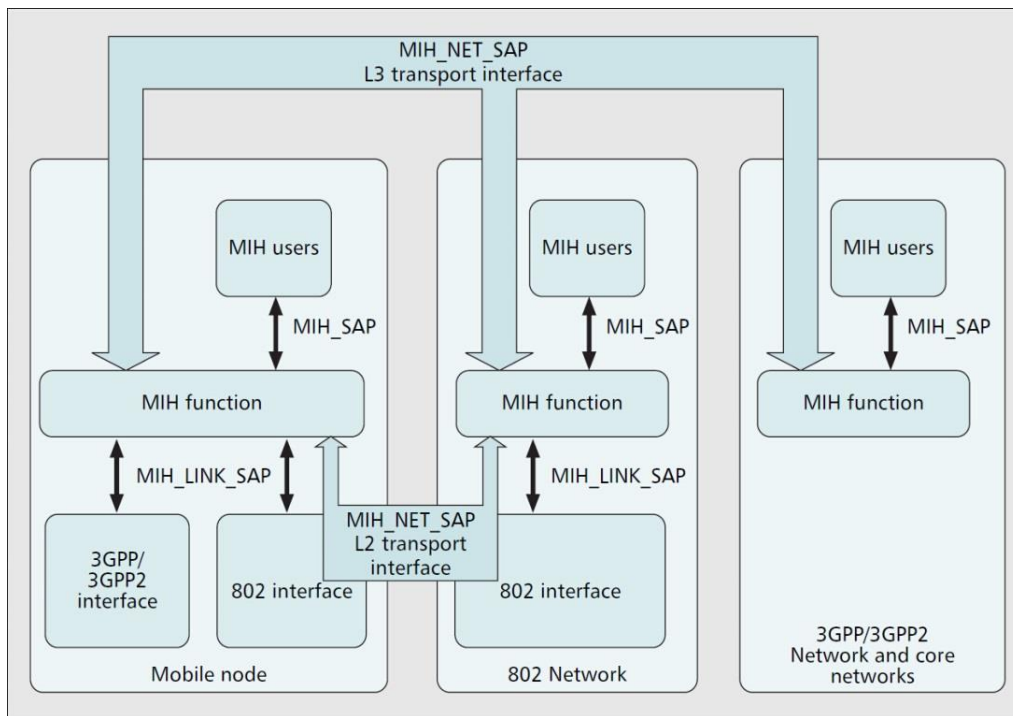

Figure 0.10: General Architecture of IEEE 802.21 [32]

Furthermore, through the cooperation and information exchange between these entities, MIHF is able to gather information, make a handover decision and execute handover procedures. From the information-gathering phase, the handover decision phase, to phase of handover execution; a significant amount of information is exchanged between different entities. In Fig 2.11 below are examples of message exchange, the information gathering phase and the handover execution phase.

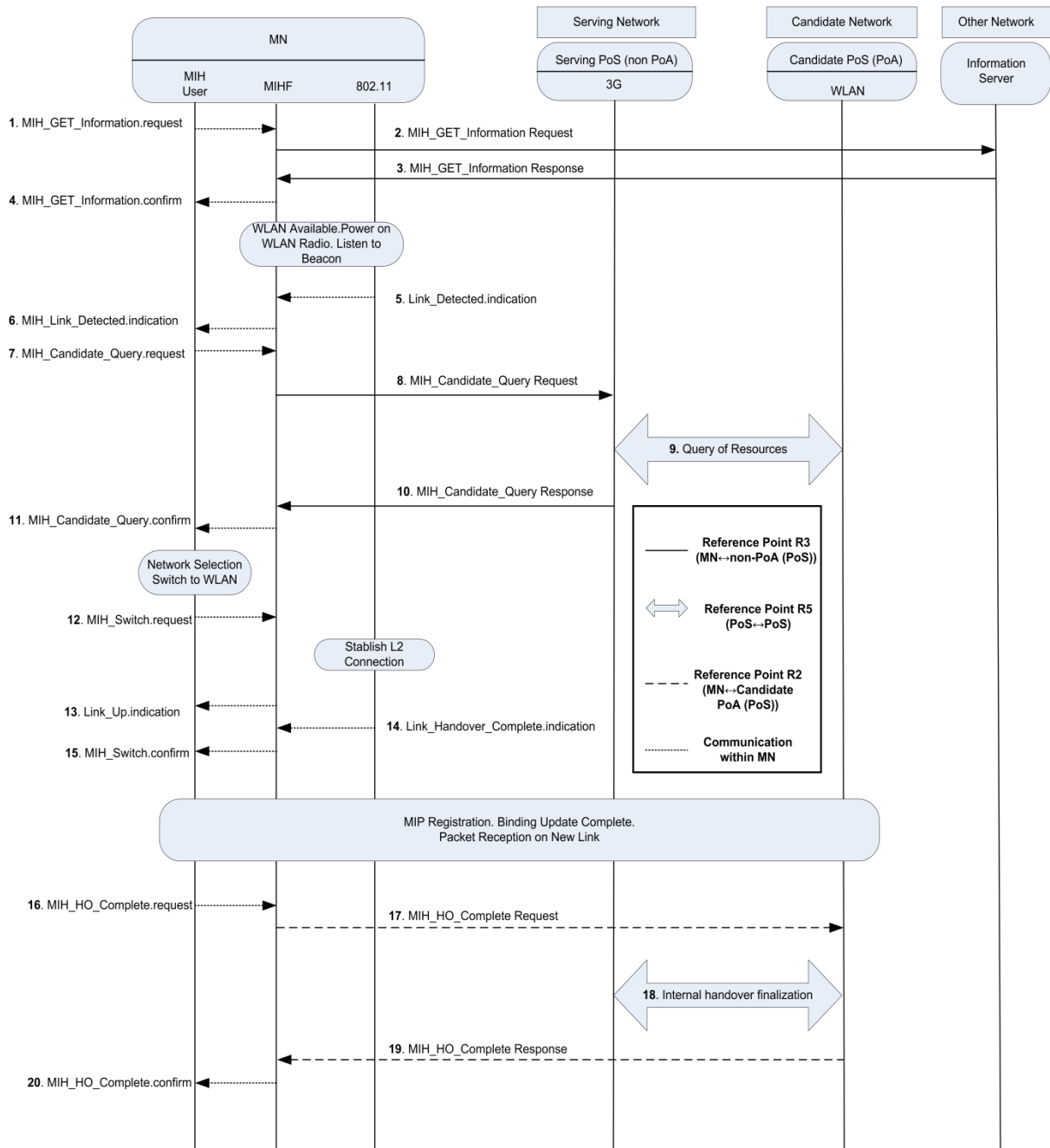

Figure 0.11: Example of VHO between 3G and WiFi [32]

- Information Gathering Phase:** In this diagram, messages n.1 to n.11 belong to the information gathering phase. Here, at the beginning of this process, MN sends the information request (Message 1) to MIHF located in MN to request information about the surrounding networks. Following this event, MIHF forwards the request message (Message 2) to the information server located in the other network and then receives a response message (Message 3) from the information server accordingly. Furthermore,

after receiving the response message, MIHF then delivers a message (Message 4) containing information about an available network to MIH user as a response to the information request. After this has occurred, MN then switches on the WiFi interface to listen for beacons from surrounding WiFi networks. Once the WiFi interface has received the beacons, it then generates a message (Message 6) containing a Link_Detected.information event and sends to MIH user to indicate that it has been detected. Following this event, after the MIH user has received the indication, it then sends a request (Message 7) to MIHF to query information about the candidate network. In response, MIHF then forwards this request (Message 8) to the serving PoS and serving PoS to collect required information (e.g. available resource and QoS parameters) from the candidate PoS (Message 9), and in turn replies with the results to MIHF (Message 10). After this event, the information about the candidate WiFi network is sent to MIH user by MIHF (Message 11). At this point, the information phase has finished, and the MIH user then takes the received results into consideration to make the handover decision.

- **Handover Execution Phase**, which is represented by messages n.12 to n.20 are involved in the handover execution. In looking at these messages, once the MIH user decides to handover to the candidate WiFi network, the Layer 2 handover is initiated by sending a request (Message 12) to MIHF to switch connection to the candidate WiFi network. After this occurs, the MIHF controls the 802.11 interface to establish a connection with the candidate WiFi access point. As the process occurs, MIHF also delivers an indication message to MIH user to indicate that the connection has begun (Message 13). Furthermore, as the connection is established, the 802.11 interface delivers an indication message (Message 14) to MIHF to indicate the completion of the Layer 2 handover and this indication is then forward by MIHF to the MIH user

(Message 15). After this is complete, the MIH user receives the indication that upper layer handover, including mobile IP selection, registration, binding update and switching packet reception has been successfully initiated. Following this event, as the upper layer handover is completed, MIH user then delivers a request message (Message16) to MIHF, and MIHF then forwards it to candidate PoS to indicate handover is completed (Message 17). Moreover, the candidate PoS then informs the serving PoS of the handover completion through exchanged messages (Messages 18). After this has occurred, the serving PoS releases the resources allocated to MN. Finally, the new serving PoS (candidate PoS) then sends a response message (Message 19) to MIHF as an indication that the handover process has finalised. Following this final stage, MIHF in turn sends a MIH_HO_Complete.confirm message to MN to indicate handover finalisation.

Overall, the MIH standard provides functions supporting seamless VHO between different networks that could be used to avoid degradation of QoE caused by VHO. However, the MIH standard only provides a default bandwidth-based VHO algorithm, which is currently unable to provide and maintain QoE of mobile services for mobile users. Because of this lacking functionality, there is a need to design an intelligent VHO algorithm to satisfy mobile users in heterogeneous wireless networks. In response to this dilemma, many VHO algorithms have been designed based on the MIH standard in recent years [34, 35]. In the following section, such existing VHO algorithms will be reviewed.

2.4. Vertical Handover Algorithms

2.4.1. Phases of Vertical Handover

To be achieved effectively for a mobile device, the handover process consists of three phases: the phase of information gathering, handover decision and handover execution. Furthermore, the basic structure of the handover process is shown below in Fig. 2.12. At the beginning of

this process, the information gathering phase always works to collect the essential information for the mobility management system to then make the handover decision based on a handover algorithm. Here, once the result of the handover decision is to handover to another network, the handover execution phase is then activated to initiate handover from the current network to the approved target network candidate.

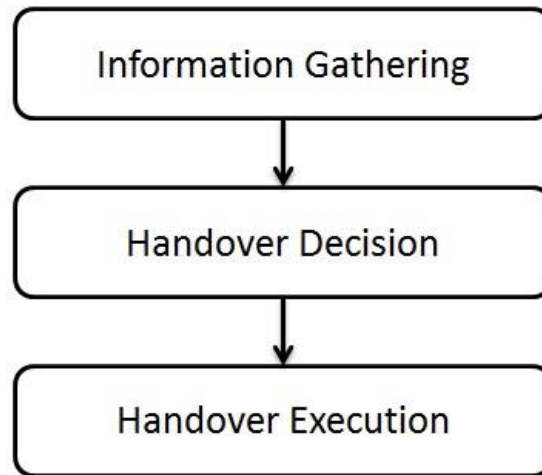

Figure 0.12: Basic structure of handover processes

Information Gathering Phase

For this phase of the handover process, the information gathering phase has different names, such as network discovery and system discovery [36]. In the information gathering phase, the mobility management system not only collects information about the networks, but also obtains information about the mobile and user preferences. These different types of collected information are shown in the Table 2.4. Most of the information obtained is about the networks that are available, as the status of each available networks is the most important parameter for assessing which network could provide high quality services after handover is complete. Furthermore, the status assessed includes battery status and speed of the device, which also dictate the handover decision and indicate the quality of handover. Additionally, user preferences such as preferred network and budget are set by the user, which also directly

limit the handover decision: the service requirements include the required throughputs, bandwidth and other factors.

Table 2.4: Different types of collected information

Types of information	Information
Available networks	Cost, Received Signal Strength (RSS), Noise Signal Ratio (NSR), Carrier to Interference Ratio (CIR), Bit Error Ratio (BER), Signal to Interference Ratio (SIR), handoff rate, distance, security and Quality of Service (QoS) of networks.
Mobile status	Battery status, speed, location and capabilities of mobile components.
User preferences	Preferred network, budget.
Services requirements	Throughput, bandwidth and types of data.

Handover Decision Phase

At this stage, the handover decision phase is the key process in mobility management, as the handover process is when the MT switches the connection from current access point (AP) to the target access point (AP) that has been selected. At this stage, there are two scenarios for the handover process: horizontal handover and vertical handover. Horizontal handover is where MT handover occurs between two APs using same network or same wireless access technology. Here, MT activates handover to the AP with the radio access technology which is different from the previous AP, called vertical handover. To illustrate this, horizontal handover and vertical handover are shown below in Fig. 2.13.

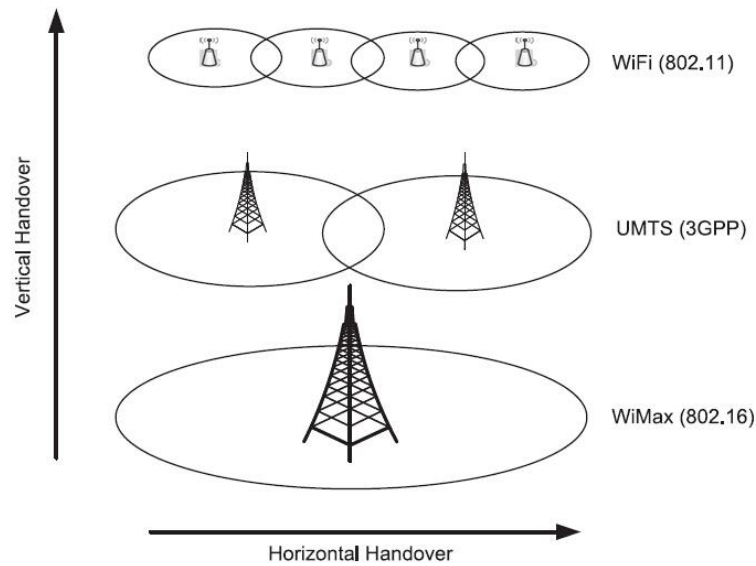

Figure 0.13: Horizontal handover and vertical handover [9]

However, in considering their differences, vertical handover is much more complicated than horizontal handover. On the one hand, MT should be implemented in the advanced network interfaces to receive and send the data based on the standards of different radio access technologies. Conversely, the handover decision phase aims to select the relatively most optimum network based on the handover decision algorithms. For this approach, the main parameter of horizontal algorithms is RSS. However, the capabilities and features of different radio access technologies are also considered by the vertical handover algorithms. Moreover, for horizontal handover, there is only one possible for MT for handover to activate. However, for vertical handover, various networks or radio access technologies may be made available for the MT at same time. Here, if the handover decision is made without considering most possible scenarios, this easily leads to very negative results such as the ping-pong whereby the MT keeps activating unnecessary handover between the two APs continuously [37]. In this case, a vertical handover decision should be made very cautiously. For vertical handover to be initiated, one of the three events need to occur: Firstly, where MT forces handover to a specific network; secondly, where due to the interface management, the active network

interface is required to be powered off; and thirdly, where current network is not able to provide sufficient bandwidth or RSS for the applications or services running on the MT. In these cases, the mobility management system calculates and analyses the collected information to select the network based on the vertical handover algorithms.

Handover Execution Phase

When the handover decision has been made, the handover execution phase is activated. In this phase, MT will disconnect the connection with the previous AP and connect to the target AP. However, the method and timing of disconnecting the previous connection and establishing the new connection is still a serious challenge for soft handover: this is because MT is unable to receive and send any data during the period between disconnecting from the previous connection and connecting to the new selected network. Furthermore, in cases where this period is too long, the service is either terminated or the quality of the service is significantly degraded. Nevertheless, if MT is able to establish the new connection much earlier than when the original connection is disconnected, network resources are wasted and increase the power consumption of MT. Due to these factors, the handover process could be classified into two types: soft handover and hard handover. On the one hand, soft handover could be referred to as making the connection with the new access point before breaking the connection with the access point it is leaving. On the other hand, hard handover could be referred to as breaking the connection with the original access point before the new connection is established. Furthermore, the aim of mobility management in a 4G network is to achieve the seamless handover while at the same time avoiding wasteful consumption of network resources. Additionally, in order to ensure the quality of service handover, many protocols are designed to control the handover execution process such as Mobile IPv4, Mobile IPv6, SIP (Session Initiation Protocol) and HIP (Host Identity Protocol).

In addition to the above, a vertical handover algorithm could be classified as either terminal-controlled or network-controlled depending on where the vertical handover algorithms are implemented, and is an argument for the vertical handover design as the terminal-controlled vertical handover algorithm would ultimately be able to satisfy the user's requirement and enable the user to control the handover decision. However, in spite of these advantages, this method requires a mobile terminal with advanced hardware and high computability. Additionally, while network-controlled vertical handover algorithms could be used to alleviate the pressure on the mobile terminal, it does not allow the users to control the handover decision, and to select the relatively best network for MT to activate vertical handover, different criteria are considered. Furthermore, many proposed vertical handover algorithms are reviewed by previous review papers [7-9, 14, 38]: Depending on the criteria, the vertical handover algorithms could also be specified as network-centric; user-centric; multi-criteria-centric; and QoE-driven. In the following subsections, the vertical handover algorithms will be reviewed as network-centric, user-centric, multi-criteria-centric and QoE-driven.

2.4.2. Network-centric Vertical Handover Algorithms

Network-centric vertical handover algorithms make handover decisions based on network parameters such as bandwidth, RSS, throughput, network utilisation and network lifetime [8, 39-41]. When those network parameters become significantly degraded, a poor network condition can easily be identified. Therefore, due to the significance of these parameters, network parameters are considered as the criteria for VHO algorithms.

Furthermore, Alzubi et al proposed a user zoning handover algorithm based on the MIH standard that aims to reduce the overhead and time consumed by the handover process and balance network utilisation [42]. In this algorithm, RSS was used to indicate the quality of the connection between the network access point and the mobile devices. Once the RSS was

below the threshold, indicating that the connection quality had reached an unacceptable level—the handover would be initiated. This approach may be effective for reducing overhead and broken connections with mobile devices that may leave the coverage of the connecting network. Nevertheless, this approach has two weaknesses: The first set-back of this approach is that the performance evaluation of the proposed algorithm is not presented by the current literature. Due to this absent method of performance evaluation, the performance of this proposed algorithm is still to be confirmed. In addition to this disadvantage, only relying on RSS is insufficient for accurately reflecting the network condition. For example, when the RSS of the connecting network is above the threshold, the quality of the connection may also reach an unacceptable level if other network parameters degrade, such as bandwidth and network utilisation.

Similarly to this approach, Zahran et al also proposed a RSS-based and lifetime-based VHO algorithm [43]. With this algorithm, both the RSS and bandwidth are taken into consideration to make the handover decision. Moreover, a flowchart representing this algorithm proposed by Zahran et al.'s is shown in Fig. 2.14 [38]. Using this approach, the RSS of connecting network is always monitored. Once the RSS from the WiFi network is received, the average RSS is measured accordingly. After this measurement, the proposed algorithm then checks whether the mobile device is connecting to a WiFi network. Here, if the mobile device is revealed to be connecting to a WiFi network, the time remaining in this WiFi network can be estimated. After this occurs, once the average RSS of the WiFi network is not higher than the acceptable level and the remaining time is determined to not be longer than handover delay, the proposed algorithm then initiates handover to the 3G network. However, if these criteria are not met, the proposed VHO algorithm instead persists to attempt connecting to the WiFi network. However, if the mobile device is deemed to not be connecting to the WiFi network, the available bandwidth of the WiFi network is estimated. Following this estimation, if the

RSS from the WiFi network is deemed at higher than the acceptable level and the estimated bandwidth is determined to be sufficient, the proposed algorithm then initiates handover to switch connection to the WiFi network. However, if these criteria are not determined, handover is not be imitated.

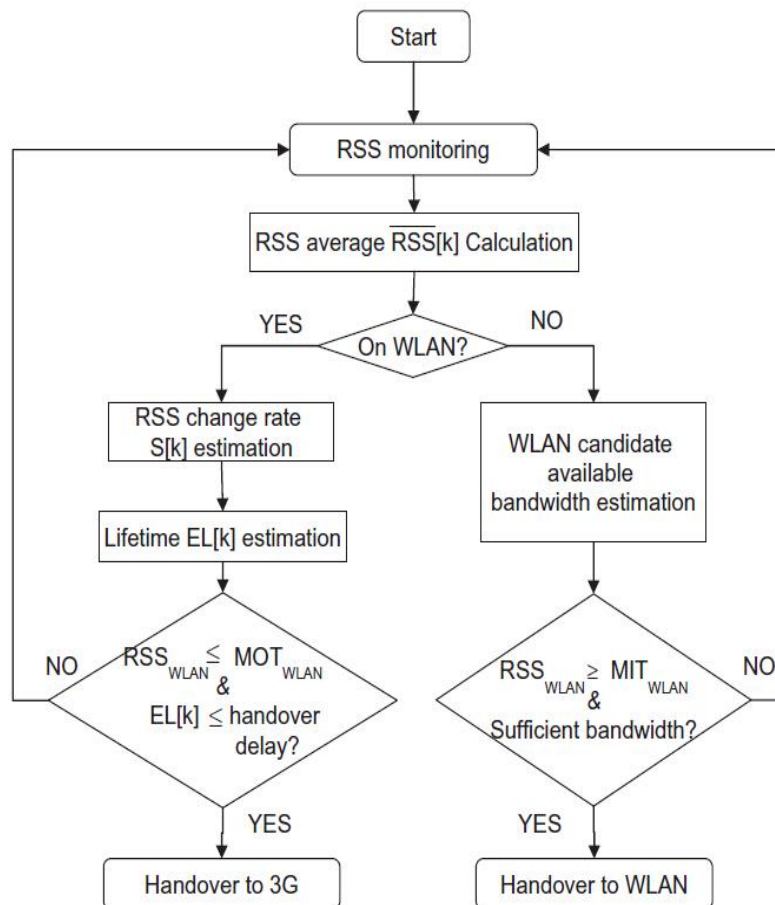

Figure 0.14: Zahran et al.'s VHO Algorithm [38]

Overall, the results of the performance evaluation demonstrate that this algorithm can effectively improve the network utilisation. However, the details of the handover were not presented clearly in the results. Furthermore, RSS, lifetime and bandwidth are unable to accurately reflect network conditions and the performance of mobile services.

In [44-48], the VHO algorithms were designed to make the handover decision based on one or several network-related criteria. However, as the dynamics of network-related criteria and

are hard to measure, they are not able to properly reflect network congestion and the performance of mobile services, and especially QoE performance. Due to these factors, it is necessary to select appropriate criteria that can accurately indicate network conditions and the performance of mobile services.

2.4.3. User-centric Vertical Handover Algorithms

The user-centric vertical handover algorithm is used to select a network on the basis of user-related information[49]. The user-related information can be the budget of the mobile user, the preferred network and other factors such as the user's favourite application [34, 41, 50-52]. Based on this approach, to achieve the seamless handover between UMTS, WLAN and WIMAX, Nguyen-Vuong et al proposed a fully terminal-controlled vertical handover algorithm for MTs with multiple network interfaces [53]. In this algorithm, terminal capabilities, movement velocity, access network characteristics and service degradation are gathered to make the handover decision, and users are also able to set the user profiles to deliberately customise the results of the handover decision. Furthermore, this algorithm applies power-saving interface management to save reduce consumption of resources. However, in the present literature, there is no detailed information about the profile settings and this algorithm does not consider whether the application is running on the MT. However, using this approach, Nguyen-Vuong et al developed and explained the fully terminal-controlled vertical handover in [54]. This developed algorithm uses factors of access network identity; cost; link quality; velocity; battery lifetime; power consumption and access network load as the criteria for making a handover decision. Moreover, in this developed algorithm, users are able to configure the user profiles to choose the mode of network selection according to the following options: application-aware network selection, and situation-aware network selection. Ultimately, this therefore enables this algorithm to satisfy the user's requirement directly. Furthermore, Sehgal and Agrawal proposed a user-centric network

selection algorithm that consider the factors of cost, available bandwidth, call drop rate and the security level as changeable preferences for the user, and used a distance function to ascribe weight-of-significance to each criterion based on the type of service [55].

Furthermore, while this algorithm could be used to select the relatively best network from various available networks that is able to satisfy the requirements of users, the authors did not explain the detail of the seamless handover process and did not consider the performance of the mobile services. Considering this approach, user-related information is very important to VHO algorithms as this information may directly reflect the unique requirements of the mobile user. Overall, based on this obtained information, the VHO algorithm can make a handover decision that is appropriate for satisfying the mobile user requirements, and especially for the QoE performance of mobile services. Due to this potential, it is necessary that user-related information is considered in the VHO algorithm.

2.4.4. Multi-criteria-centric Vertical Handover Algorithms

Known as multiple attribute decision (MAD) strategies, while multi-criteria-centric vertical handover algorithms are the most effective algorithm, they are also the most complicated to implement. Currently there are several popular MAD methods such as Simple Additive Weighting (SAW), Multiplicative Exponent Weighting (MEW), Technique for Order Preference by Similarity to Ideal Solution (TOPSIS), Analytic Hierarchy Process (AHP) and Grey Relational Analysis (GRA) [56-64].

Furthermore, the SAW method includes two steps to select the network. Firstly, it sets the values to all attributes of each available network, and then compares the sum of all attributes of each available network. The selected network in SAW is shown as Eq. (2.1):

$$A_{SAW}^* = arg \max_{i \in M} \sum_{j=1}^N w_j r_{ij} \quad (2.1)$$

The M denotes the number of available networks and the N stands for the number of attributes. Furthermore, the i, j, w_j and r_{ij} represent the network i , the attribute j , the weight of the attribute j and the attribute j of the network i [65-68]. The contribution can be calculated based on either for benefit or for cost. A network selection can also be based on minimizing the cost or maximising the benefit.

In the MEW method, the problem of network selection is transformed into a matrix form where the row i and column j represent the network and attribute. The score S_i of the network i in MEW are given by Eq. (2,2):

$$S_i = \prod_{j=1}^N x_{ij}^{w_j} \quad (2.2)$$

The N means the number of attributes and the i, j, w_j and x_{ij} represent the network i , the attribute j , the weight of the attribute j and the contribution from the attribute j of the network i , respectively, and $\sum_{j=1}^N w_j = 1$. There is a positive and ideal network in the MEW method and its score is $S^{**} = \prod_{j=1}^N (x_{ij}^{**})^{w_j}$. The ratio R_i between each available network and the ideal network is represented by the equation: $R_i = \frac{S_i}{S^{**}}$ ($0 \leq R_i \leq 1$). For the benefit attribute, the best network has the largest value so that the selected network is given by Eq. (2.3):

$$A_{MEW}^* = \arg \max_{i \in M} R_i. \quad (2.3)$$

Conversely, the best network has the lowest value for the cost attribute and the selected network is given by Eq. (2.4):

$$A_{MEW}^* = \arg \min_{i \in M} R_i. \quad (2.4)$$

When using the TOPSIS method, the best network is deemed to be the one which is the closest to the ideal network and the farthest to the worst network [58, 69-72]. The ideal network means the value of each attribute is at the optimum level. Additionally, the closeness of the available network to the ideal network is represented by c_i^* and the selected network in the TOPSIS is given by Eq. (2.5):

$$A_{TOP}^* = arg \max_{i \in M} c_i^*. \quad (2.5)$$

The AHP method is used to find the best solution by deconstructing the decision problem into a number of sub-problems and integrating the relative dominances of the sub-problem with the solution alternatives [56, 73-75]. In AHP method, there are three main steps to select the suitable network. Firstly, it divides the decision problems into several sub-problems at different levels based on the criteria, and then assigns the weight value to each sub-problem. Secondly, each factor is compared with all other factors at the same level through the pairwise comparison matrix. Finally, the best solution is deemed to be the one with the highest sum of weights of each different level. However, as the AHP is insufficient for deconstructing the decision problem with imprecise criteria, it usually is used to cooperate with other advanced methods of selecting a network.

Furthermore, the GRA method constructs the grey relationships between comparative series with the ideal series to identify the best series [57, 73, 76-78]. There are six main steps to select the best series in the GRA method. Firstly, the elements of series are classified into three different situations: larger-the-better, smaller-the-better and the-more-nominal-the-better. After, the lower, moderate and upper bounds are defined as $l_j = \min\{x_1(j), x_2(j), \dots, x_n(j)\}$, m_j and $u_j = \max\{x_1(j), x_2(j), \dots, x_n(j)\}$. The moderate bound m_j is just used in the-more-nominal-the-best situation as the target value. Following

this, the third step is to nominalise the individual entities of the three situations (larger-the-better, smaller-the-better and the-more- nominal-the-better) based on the equations as below:

$$x_i^*(j) = 1 - \frac{x_i(j)-l_j}{u_j-l_j}. \quad (2.6)$$

$$x_i^*(j) = 1 - \frac{u_j-x_i(j)}{u_j-l_j}. \quad (2.7)$$

$$x_i^*(j) = 1 - \frac{|s_i(j)-m_j|}{\max\{u_j-m_j, m_j-l_j\}}. \quad (2.8)$$

After completed the former, the fourth step is to define the ideal series that contain the upper bound, lower bound or moderate bound in the three different situations. Then the fifth step is to calculate the grey relational coefficient (GRC) based on the Eq. (2.9):

$$GRC_i = \frac{1}{m} \sum_{j=1}^k \frac{\Delta_{min} + \Delta_{max}}{\Delta_i + \Delta_{max}}. \quad (2.9)$$

From the above equation, $\Delta_i = |s_0^*(j) - s_i(j)|$, $\Delta_{max} = \max_{(i,j)}(\Delta_i)$ and $\Delta_{min} = \min_{(i,j)}(\Delta_i)$.

The final step is to select the series with the largest GRC as $A_{GRA}^* = \arg \max_{i \in M} GRC_i$.

Furthermore, a network selection algorithm was proposed by QingYang and Jamalipour that combined AHP and GRA [57, 73]. With this algorithm, AHP is used to divide the decision problem into different sub-problems into different levels, and then assign the weight to each sub-problem. After this step, it will then use the GRA to select the best solution. Additionally, the authors also conducted some simulations to test the algorithm: the results of the simulation showed that this algorithm could not only ensure an efficient seamless handover when the real-time and non-real-time services were running on the mobile device, but also that its implementation could be simplified. However, it should be mentioned that this algorithm also focuses on the QoS to select the network without considering the QoE.

Based on the simulation, Stevens-Navarro and Wong compared four different multiple-centric handover algorithms SAW, TOPSIS, GRA and MEW that simulate the handover between UMTS, GPRS and two WLANs [58]. Within this simulation, the authors applied four types of traffic: conversational, streaming, interactive and background. Additionally, available bandwidth, end-to-end delay, jitter and BER were considered as the criteria for the simulation. Overall, the results demonstrated that the performance of MEW, SAW and TOPSIS were similar for the four types of traffic. Nevertheless, it appears that GRA could provide better performance with a slightly higher bandwidth and a lower delay for interactive and background traffic. However, this comparison did not consider the criteria of the mobile status factors and QoE, with the resulting considered factors being relatively less.

In addition to this approach, Markaki proposed a network selection algorithm to improve the QoE based on the combination of AHP and GRA [79]. However, within this algorithm, there is no QoE parameter. However, Jacob and Preetha developed a network selection algorithm based on both QoS and QoE [80]. In this developed algorithm, there is a memorisation mechanism to store the list of QoS and QoE which contain nominalised values of the QoS and QoE parameters. However, in spite of accounting in-part for user QoE, there is no evaluation of the developed algorithm in the present literature and the performance of this algorithm still needs to be confirmed.

Furthermore, multi-criteria-centric VHO algorithms are able to analyse several criteria to distinguish between network conditions so that these algorithms can target the network with the best network condition. However, always connecting to the network with the best conditions can easily cause imbalance in network utilisation and unnecessary levels of handover. Additionally, these algorithms only focus on the QoS performance of mobile services and ignore the QoE performance of mobile services and the actual requirements of the mobile user.

2.4.5. QoE-driven Vertical Handover Algorithms

As most of the existing VHO algorithms fail to account for the QoE of mobile services, which has become more and more important to mobile users in recent years; to provide and maintain QoE of mobile services in heterogeneous wireless networks effectively, it is necessary to incorporate the QoE parameters into VHO algorithms. Furthermore, the existing QoE-driven VHO algorithms will be reviewed in this section.



Figure 0.15: Different factors in relation to QoE [81]

In heterogeneous wireless networks, there are many factors which can impact the QoE of mobile services, such as the performance of the mobile services, the device efficiency and quality of the network. Below, Fig. 2.15 illustrates the QoE-related factors that would need to

be considered in the design of VHO algorithms [81]. Due to these different factors, some researchers consider one of such QoE factors as a criterion when designing QoE-based VHO algorithms, such as power, security and the performance of mobile services [82-86].

In one approach, Kim proposed a QoE-driven mechanism of WiFi selection to choose the best WiFi network from among the available WiFi networks [83]. In this QoE-driven mechanism, SINR is used to represent the QoE of multimedia services. Furthermore, the validation of this mechanism was carried out on OPENT network simulator and a real testbed. According to the results, it was demonstrated that the proposed mechanism could be used to increase the throughput and select the WiFi network with the best SINR. However, while the throughput and SINR are important factors that can affect the QoE of multimedia services, throughput and SINR alone are still unable to ensure the good QoE of multimedia services and satisfy the specific needs of the mobile user. Additionally, if a high packet loss rate was caused by congestion in the WiFi network with the best SINR, the QoE of multimedia services would in fact be significantly degraded. Because of this, when designing a QoE-based VHO algorithm, selecting the appropriate QoE-related criteria is necessary.

Furthermore, Kim designed a QoE-aware mobility management scheme based on the MIH standard to improve the QoE in mobile services when connected to a heterogeneous wireless network [82]. Under this scheme, an energy profile was designed to inform mobile users about the power consumption of the connected network. In addition to this feature, this scheme also implemented a user preference function to obtain the requirements of the mobile user on energy consumption, and was an effective way to ensure mobile user satisfaction. In addition to accounting for preferred energy consumption in this scheme, handover latency was also used to represent QoE performance of mobile services. In this simulation, it was demonstrated that both handover latency and power consumption were improved. However, in spite of these advances, this scheme contains three weaknesses: Firstly, the proposed

scheme only incorporated the factor of power consumption into the VHO algorithm, which could not be used to directly reflect and ensure the QoE of mobile services. Secondly, the results of the simulation did not show that the proposed scheme could maintain the QoE of mobile services in heterogeneous wireless networks. Moreover, in the results, the QoE of mobile services significantly degraded several times throughout the simulations. Lastly, the design of the simulation also ignored the factor of network congestion that was more likely to impact the QoE of mobile services than power consumption. Due to these results, in order to maintain a strong QoE in mobile services across heterogeneous wireless networks, the QoE performance of mobile services should be considered when VHO algorithms are designed.

In order to address this concern, Jailton et al. proposed a QoE handover architecture to maintain the QoE of multimedia services based on the MIH standard [87]. In this handover architecture, the QoE of mobile video services was incorporated into the VHO algorithm. Furthermore, a QoE adaptation scheme was applied to the architecture to maintain the QoE of mobile video services by adapting the parameters and dropping unimportant video frames. The performance evaluation of the proposed handover architecture was carried out on Network Simulator 2 (NS2) with WiFi network and WiMAX network. Overall, the results of the simulation revealed that the proposed handover architecture could provide a better level of QoE performance than the default scheme of MIH. However, in spite of this insight, the proposed handover architecture is limited by three factors: Firstly, this approach only considers network conditions and video parameters, which are not sufficient for measuring the QoE of a mobile video service, as the content of the video itself may also significantly impact the QoE of a mobile video services [4]. Therefore, if the proposed handover architecture were able to consider the types of video content when measuring the QoE of mobile video services, the QoE of mobile video services may be able to be estimated at a higher accuracy. Secondly, the details of handover algorithm were not explained and clarified

in sufficient detail, such as methods of selecting a target wireless network and deciding when handover should be initiated. Furthermore, the results of the simulation so revealed not details on the handover process. Because of this lack of detail, the impacts of the handover algorithm and the QoE adaptation scheme were hard to differentiate from one another. Lastly, as the actual requirements of the mobile users were ignored by the proposed handover architecture, this would directly impact the satisfaction of the mobile user.

In addition to the above approach, Quadros et al. also designed a QoE handover system to maintain the QoE of mobile video services when delivered over heterogeneous wireless networks [88]. To achieve this, the handover system applied a cluster-based Multiple Artificial Neural Network (MANN) model to estimate the QoE of mobile video services. Furthermore, this system also applied a QoE-adaptation model to adjust the video parameters for congestion recovery. Additionally, the performance evaluation of this handover system was carried out by using NS2 and Evalvid. In conducting the evaluation, the simulation results showed that the proposed handover system could effectively maintain the QoE of mobile video services in heterogeneous wireless networks. However, despite this focus on heterogeneous wireless networks, this handover system still ignored the movement of the video content and the actual requirements of the mobile users. Moreover, the results from the simulations did not reveal any details about handover and the state of the network connection, which are both important for analysing the impacts of handover and QoE adaptation.

In [89-93], the QoE-driven VHO algorithms were designed on the basis of different QoE-related criteria. In this case, the QoE-driven VHO algorithms could improve the QoE performance of mobile services for mobile users at some points. However, among these QoE-related criteria, two factors appear to be the most important for the mobile user: the cost of accessing a network and the performance of the mobile services. Firstly, apart from users with unlimited data plans, the majority of mobile users do take the cost of network access

into consideration. For this reason, free WiFi networks are able to attract more customers in public places, such as in shopping centres and on buses. Because of this, as most mobile users have no background knowledge of what constitutes a heterogeneous wireless network; when wireless networks become congested, these users only notice the degradation in QoE performance of the mobile services rather than the reason that led to the network becoming congested. Furthermore, the actual requirements of the mobile user are also important for QoE-driven VHO algorithms. Once the actual requirements of the mobile user are obtained, the VHO algorithms would easily be able to make the corresponding handover decision to satisfy the mobile user.

Table 2.5: Features of existing QoE-driven VHO algorithms

Vertical Handover Algorithms	Input Parameters	Advantages	Weakness
QoE-driven Wi-Fi Selection Mechanism [83]	SINR	High throughput	SINR cannot directly represent QoE performance
QoE-aware mobility management scheme [82]	Power consumption and handover latency	Reduced handover latency and power consumption	Only consider power consumption and handover latency cannot maintain QoE performance
QoE handover architecture [87]	Video parameters and packet loss rate	Improved QoE performance	Ignored the impacts of video content and cost on QoE performances
QoE handover system [88]	Video parameters and packet loss rate	Improved QoE performance	Ignored the impacts of video content on QoE performances and users' requirements
NLP-handoff scheme [91]	RSSI and variable bitrate video coding	Reduced handover delay and improved QoE performance	RSSI cannot directly represent QoE performance
QoE-aware VHO algorithm [92]	QoS parameters and packet loss rate	Improved QoE performance and load distribution	Ignored video parameters and users' requirements

Table 2.5 shows the features of existing QoE-driven VHO algorithms. To compare and summarise those QoE-driven VHO algorithms that appropriate video parameters and video content should be considered into designing of QoE-driven VHO algorithm to reflect QoE performance of video services. Furthermore, actual users' requirements also should be taken into account to satisfy mobile users.

2.4.6. Comparison of Vertical Handover Algorithms

When comparing vertical handover algorithms, it appears each different type of vertical handover algorithm has its unique set of advantages and disadvantages. On the one hand, the network-centric vertical handover algorithm could be used to select a suitable network for the user while at the same time efficiently balancing the utilisation of different networks. However, despite these strong points, the network-centric vertical handover algorithms could not ultimately satisfy the user requirement in that the algorithms selected a network without considering the mobile user preferences. On the other hand, the user-centric vertical handover algorithm differs in this area by aiming to select the most suitable network based on the user preferences. However, in spite of this closer consideration of the user, the user-centric vertical handover algorithms only consider a few criteria that alone could not be used to maintain QoS and QoE performance of mobile services in heterogeneous wireless networks effectively. When considering further alternatives: when compared to the network centric and user-centric vertical handover algorithms, the multi-criteria-centric VHO algorithms are much more complex and efficient for selecting the most suitable network with a comparably much wider range of criteria than the former. However, in spite of this wider set of criteria, the multi-criteria-centric VHO algorithms only focus on the QoS performance of mobile services and ignore the QoE performance of mobile services.

Furthermore, the QoE of mobile services have become increasingly important to mobile users in recent years. As the above VHO algorithms make the handover decision according to QoS

parameters, one of these current algorithms are able to maintain the QoE of mobile services in heterogeneous wireless networks. Moreover, as QoE-driven VHO algorithms are designed to make handover decisions based on QoE-related criteria, QoE-driven VHO algorithms are therefore more effective and efficient for maintaining QoE of mobile services in heterogeneous wireless networks than the other above VHO algorithms. However, in spite of its higher focus on QoE when compared to the other algorithms, the existing QoE-driven VHO algorithms could be improved to result in better satisfaction for mobile users in the future.

2.5. Summary

Overall, this chapter reviewed state-of-the-art of mobility management protocols, the MIH standard and existing VHO algorithms in heterogeneous wireless networks. In reviewing the current implementations, the protocols are designed based on MIPv6 to support and improve VHO in heterogeneous wireless networks, and the MIH standard can provide seamless VHO between UMTS, WiFi and WiMAX. However, in spite of these advances, the MIH standard provides only a default VHO algorithm to make the handover decision, which is not sufficient for making a handover decision appropriate to the specific needs of the end user. Moreover, Due the importance of QoE of mobile services, QoE-related criteria become more and more important in VHO algorithms. Additionally, current QoE-driven VHO algorithms are able to provide and maintain a better QoE of mobile services than other VHO algorithms. Furthermore, the existing QoE-driven VHO algorithms explored in this chapter could be improved by taking into account the type of video content, the factor of cost, and the actual requirements of the mobile user. Due to these advances and weaknesses in the current algorithms, this project will first design a QoE-driven VHO algorithm based on the MIH standard. Following this step, the QoEd-driven VHO algorithm will be developed for a QoE-driven VHO management framework to provide and maintain the QoE of mobile multimedia

services according to the actual requirements of the mobile user. However, in order to design a QoE-driven VHO algorithm capable of maintaining QoE of mobile multimedia services effectively, an investigation on the QoE performance of mobile multimedia services will need to be carried out, and is the focus of the following Chapter.

Chapter 3: QoE Evaluation of Voice and Video Call Services over WiFi

3.1. Introduction

In recent years, mobile video services have become one of the most popular services for the mobile user. On the one hand, more and more mobile users are using mobile video services over heterogeneous wireless networks, and mobile video services increasingly dominate the data traffic on mobile networks [1]. On the other hand, the QoE of mobile video services has become more and more important to the mobile user. In response to these two trends, it is important to incorporate the QoE of mobile video services into the design of a QoE-driven VHO algorithm. Before investigating the QoE-driven VHO algorithm, it is necessary to understand the following two research questions: First, how will the QoE of a mobile video service be affected over a wireless network? And second, how do current mobile video services react to the degradation of QoE due to network impairment? Mobile video services consist of interactive services, such as voice and video calls in a VoIP application, and video streaming services, such as live video streaming and VoD streaming. In this Chapter, we focus on the investigation of QoE for voice/video call or VoIP applications. There are many VoIP applications such as Skype, Google Talk and Yahoo Messenger that could be used to address these research questions [94]. Among these video call applications, Skype is the most popular and successful VoIP application worldwide, with the largest number of users and reported to peak at 45,469,977 concurrent users online in 2012. In order to effectively investigate the research questions mentioned above, the Skype platform was used in this study for delivering mobile video services over WiFi, and at same time its QoE was assessed.

The purpose of this chapter is to understand the QoE performance of mobile video services so as to help design a QoE-driven VHO algorithm with consideration of mobile video services.

The remaining of the Chapter is organised as follows. In Section 3.2, the related research about the existing QoE recovery methods applied in Skype will be explored. Following this section, Section 3.3 will depict the experiment testbed. Once this section is concluded, Sections 3.4 and 3.5 will then present the performance evaluation of Skype voice calls and video calls. To conclude this chapter, Section 3.6 will then summarise the results.

3.2. Related Work

There are several researchers who have investigated methods to assess QoE optimisation mechanisms used in Skype, e.g. how Skype reacts to different packet loss rates or changing network bandwidth. Te-Yuan et al. investigated Skype's forward error correction (FEC) mechanism which is used to effectively recover quality by encapsulating several data into one FEC block [95]. Furthermore, Te-Yuan et al. found that Skype's audio quality was able to be improved by balancing the needs of users with network efficiency. In addition to this finding, Xinggong et al. indicated that Skype reduced its sending rate and frame rate with the increasing of packet loss rate [96]. Additionally, they also discovered that Skype applied two models for FEC mechanisms based on the threshold of packet loss rate (e.g. 10%): in instances where the packet loss rate was less than 10%, Skype maintained the sending rate but reduced the frame rate rate for the FEC mechanism to recover lost packets. However, in instances where the packet loss rate was higher than 10%, Skype significantly decreased its sending rate as well as the video rate in order to allocate sufficient bandwidth to the FEC mechanism. In order to address such scenarios, De Cicco and Mascolo proposed a model for creating a congestion control mechanism for Skype voice calls in terms of packet loss rate and available bandwidth [97]. As well as exploring this area, researcher De Cicco et al. also investigated the responsiveness of Skype video calls in response to different changes in levels of available bandwidth [98]. Furthermore, they also conducted an experiment to investigate behaviours of Skype video flows under different network conditions [99]. In [96], [98] and

[99]: the results of this experiment indicated that Skype was Transmission Control Protocol (TCP)-friendly.

However, in spite of these insights, most of the previous research on Skype voice and video calls only focuses on packet loss rates at levels less than 10%. Furthermore, an investigation into Skype video congestion control mechanisms when subject to different forms of video content has been ignored. Due to these weaknesses, this project aims to investigate how Skype congestion control mechanisms change parameters such as payload size, inter-arrival time and throughput in response to diverse network conditions. In conducting this experiment, the investigation will be based on the packet loss rate at the range of [0%, 20%] and the available bandwidth between 100 Kbps and 1700 Kbps. Additionally, this paper also investigates how Skype congestion control mechanisms react to different forms of video content under different network conditions, and subjective tests are also conducted to obtain the MOS values that depict the QoE of Skype voice and video calls under different network conditions.

3.3. Experimental Testbed Setup

In order to conduct Skype voice and video calls under different network conditions via a wireless network, a testbed was assembled that consisted of two Laptops installed with Windows 7 and two wireless routers (Netgear WGR614v8) connecting to the Internet as shown below in Fig. 3.1.

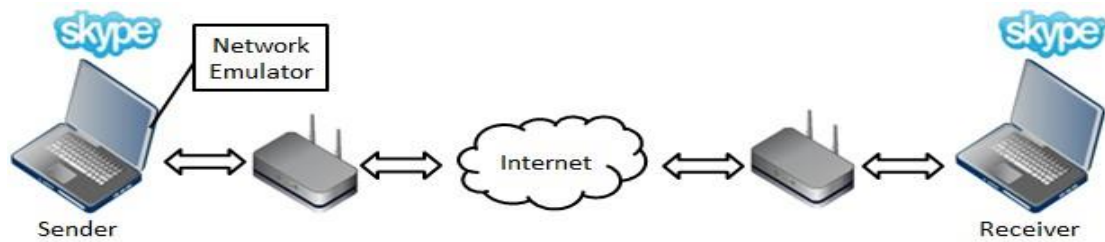

Figure 0.1: Testbed for Skype voice/video call

In this testbed, the Network Emulator for Windows Toolkit (NEWT) [11] is used to emulate different network conditions. This is installed on the ‘Sender’ laptop. Additionally, standard voice samples or video clips are injected into the Skype Sender machine by using Virtual Audio Cable and ManyCam [12, 13]. In this testbed, voice and video traffic is captured by Wireshark: with this platform, voice is recorded on side of the receiver by Audacity, whereas the video is recorded by SuperTintin.

Using this set-up, we carried out experiments on Skype for voice calls and video calls. Due to the low bandwidth requirements of Skype voice calls, the experiments with the congestion control mechanism and performance of Skype voice calls are only conducted under different packet loss rates. Here, the packet loss rate is increases incrementally at increments of 2% every 1 minute from 0% to 20%: this enables this experiment to investigate how Skype adjusts the sending bit rate, inter-arrival time and throughput. After reaching 20%, the packet loss will be reduced from 20% to 0% to investigate whether Skype would immediately readjust its parameters in response to significant change in network conditions. In this experiment, the sample voices ‘BRITISH_ENGLISH’ from ITU-T P.50 [14] are used in the voice call test and each test lasted for 12 minutes (720 seconds).

Furthermore, experiments on Skype video calls under different packet loss rates were conducted, and similarly as in voice call experiments described above. When considering the high bandwidth requirements for video calls in contrast to audio calls, we also carried out Skype video call experiments under different available bandwidth conditions. In this

experiment, the available bandwidth was decremented by 200 Kbps every 60 seconds from 1700 Kbps to 100 Kbps. After reaching 100 Kbps and waiting for 1 minute, the available bandwidth suddenly increased to 1700 Kbps. This change, known as “square waves”, is repeated three times 1 minute intervals. Additionally, this experiment also used three video clips with different forms of motion (‘hall’, ‘foreman’ and ‘stefan’) to investigate whether the Skype congestion control mechanism takes video motion into consideration when adjusting its parameters.

Furthermore, in order to investigate the QoE of Skype voice and video calls under adverse network conditions, subjective tests were conducted which involved 20 volunteers who listened to and watched the recorded voice and video calls. Within this group of participants, there were 10 males and 10 females aged between 18 and 30 years old. Then, depending on the average MOS, the QoE of Skype voice calls and video calls was analysed according to different packet loss rates and different levels of available bandwidth.

3.4. Performance Evaluation of Skype Voice Calls

3.4.1. QoS Analysis of Skype Voice Calls

In this section, the experimental results on the parameters of Skype voice call are presented and analysed to investigate how Skype adapts its parameters to recover QoS and QoE in different network conditions. In Figs. 3.2, 3.3 and 3.4, average and detailed payload sizes, inter-arrival time and throughputs under different packet loss rates are shown.

Payload size

The payload size of each packet has been recorded during the voice call in experiments. Hence, how Skype adapts payload size in different network conditions could be investigated. As shown in Fig. 3.2 below, Skype increased its average payload sizes from an average of 80 Bytes to 175 Bytes when the packet loss rate increased from 0% to 10%. Then when packet

loss rate increased from 10% to 14%, Skype reduced the average payload size from an average of 175 Bytes to 120 Bytes. Furthermore, when packet loss rate continued to increase, Skype retained the exact same average payload size at an average of 120 Bytes. However, in the instance when the packet loss was rate was suddenly reduced from 20% to 0%, the average payload size was reduced gradually to about 110 Bytes.

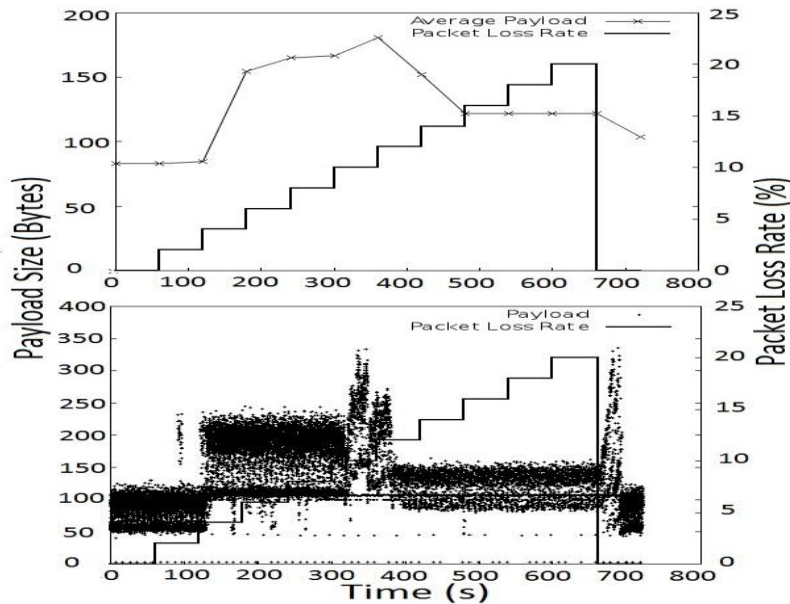

Figure 0.2: Payload sizes under different packet loss rates

According to the detailed graph on payload sizes above, Skype adopted different methods to adjust payload size based on four categories of packet loss rate from 0% to 20%.

- **Category 1: [0%, 2%].** Skype kept the payload size unchanged.
- **Category 2: [2%, 10%].** Skype used a larger payload size than the one in Category 1 and kept it unchanged. There are two bands of payload size, with the majority at high band at around 200 Bytes, and a minority at a low band of around 100 Bytes. This indicates that Skype applied FEC to recover lost packets.
- **Category 3: [10%, 14%].** Within this packet loss range, Skype appears to have had a wide range of payload sizes, an overall increased payload size and a very active adaptation scheme.

- **Category 4: [14%, 20%].** In this category, Skype kept the payload size unchanged. Two bands of payload sizes exist, indicating that the FEC is being applied.

Interarrival time

In order to investigate how Skype adjusts the interarrival time of every two consecutive sending packets in congested network, the interarrival time were measured during the experiments. As shown below in Fig. 3.3, Skype kept the average interarrival time stable at 20ms as the packet loss rate increased from 0% to 10%. However, when the packet loss rate increased from 10% to 14%, the average interarrival time significantly increased to an average of 60ms. Furthermore, with the packet loss rate at above 14%, Skype slowly increased the average interarrival time. Conversely, when the packet loss rate directly reduced to 0% from 20%, the average interarrival time significantly decreased to about 25ms. Overall, the four categories are shown below.

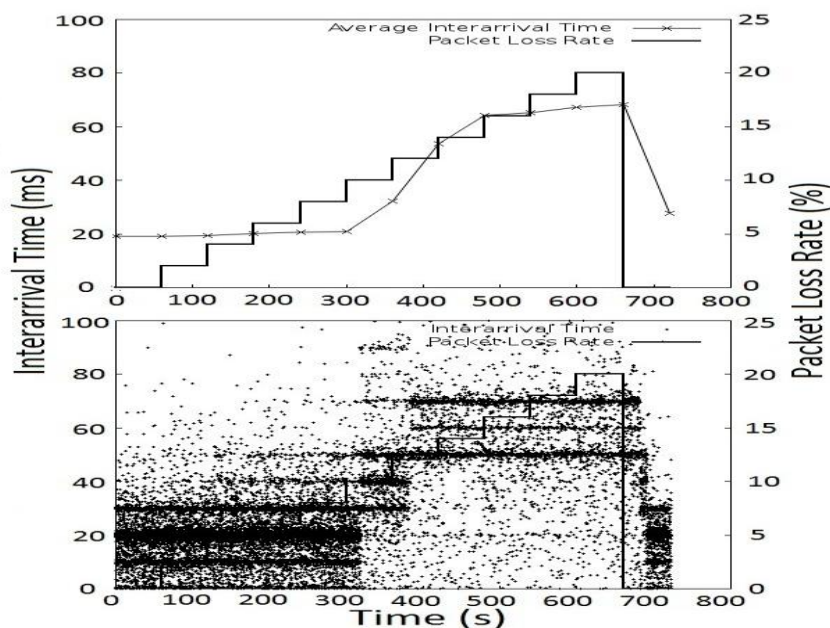

Figure 0.3: Interarrival times under different packet loss rates

- **Category 1: [0%, 2%].** Skype used three interarrival times (10ms, 20ms and 30ms) to send most of packets. This could be explained by varying payload size such as including one-to-three speech frame per packet. In this category, the speech frame length is 10ms.

- **Category 2: [2%, 10%].** In this category, Skype started to use other two large interarrival times (40ms and 50ms) to send more and more packets with the packet loss rate increasing. As a result of this, Skype uses five interarrival times to send most of packets at the same time (one packet includes one-to-five speech frames with the majority at a 20ms interarrival time).
- **Category 3: [10%, 14%].** Skype used interarrival times of 30ms, 40ms and 50ms when sending most packets at the same time. Some packets were sent by the interarrival time of 70ms, 80ms and 90ms.
- **Category 4: [14%, 20%].** With this category, Skype used interarrival times of 50ms, 60ms and 70ms to send packets.

Throughput

Throughput is the key parameter for multimedia services that high throughput could ensure the good quality of multimedia service in good network condition. However, high throughput might make worse QoS and QoE of multimedia services in congested network. To investigate how Skype adjusts throughput of voice service in congested network, the changes of throughput was measured during every voice call in the experiments. As represented in Fig. 3.4 below, the average throughput increased significantly from about 32 Kbps to 60 Kbps as the packet loss rate increased from 2% to 4%. Furthermore, when the packet loss rate increased from 10% to 14%, the average throughput was dramatically reduced to about 14 Kbps from 43 Kbps. Moreover, the average throughput was reduced to almost half its original level once the packet loss rate increased. Additionally, the average throughput decreased slightly as the packet loss rate increased from 16% to 20%. Nevertheless, it was notices that when the packet loss rate directly decreased to 0% from 20%, the average throughput was significantly increased.

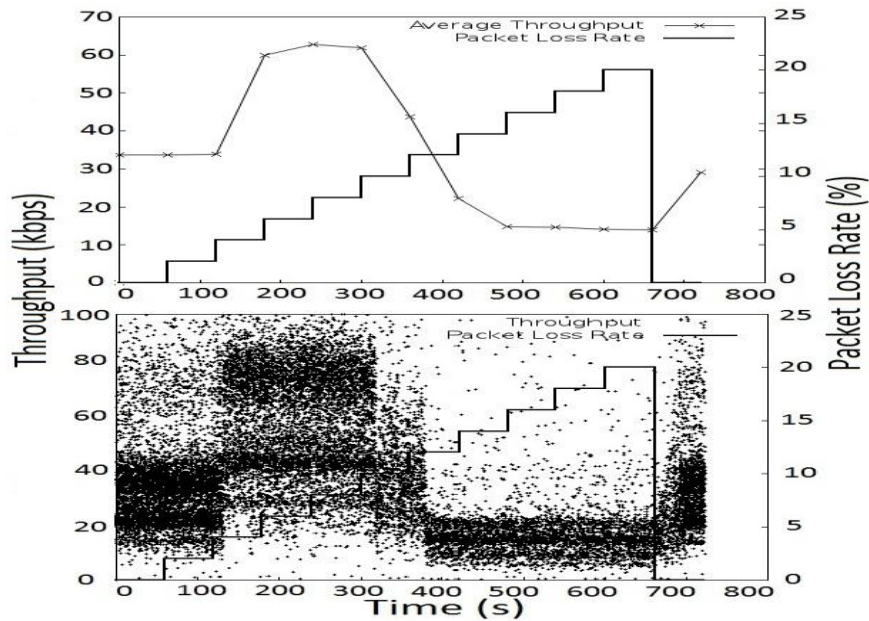

Figure 0.4: Throughputs under different packet loss rates

Depending on the details of the results, it was clear that Skype adjusts its throughput based on four categories of packet loss rates. The main thresholds were 2%, 10% and 14%.

- **Category 1: [0%, 2%].** Skype maintained an unchanged throughput.
- **Category 2: [2%, 10%].** Skype used a larger throughput than the one in Category 1 and kept it unchanged. The reason for this was that Skype used FEC to recover the lost packets, which significantly increased payload sizes but kept interarrival times unchanged.
- **Category 3: [10%, 14%].** Skype kept throughput at values lower when compared to Category 2.
- **Category 4: [14%, 20%].** Skype maintained an unchanged throughput at a level lower than that of Category 1.

3.4.2. QoE Analysis of Skype Voice Calls

For this part of the experiment, subject tests were used to investigate the QoE of the recorded Skype voice call under different packet loss rates. In this investigation, they compared the recorded voice calls and the sample voice. The average MOS results are shown in Table 3.1.

Table 3.1: The average MOS of Skype voice call under different packet loss rates

Packet loss rate	0%	2%	4%	6%	8%	10%
Average MOS	4.8	4.5	4.25	4.1	3.75	3.5
Packet loss rate	12%	14%	16%	18%	20%	20%-0%
Average MOS	3.35	3.15	2.9	2.3	1.65	3.95

As demonstrated above in Table 3.1, the QoE of Skype voice calls under packet loss rates from 0% to 10% is good (higher than 3.5). Then, MOS is seen to decrease in response to the decrease in package loss rate. However, when the packet loss rate was reduced directly from 20% to 0%, the QoE of Skype voice call immediately returned to a high standard. In general, the Skype congestion control mechanism could effectively recover the quality of voice calls when the packet loss rate was between 0% and 10%. Conversely, when the packet loss rate was higher than 10%, the quality of Skype voice calls was significantly reduced.

3.5. Performance Evaluation of Skype Video Calls

3.5.1. QoS Analysis of Skype Video Calls

3.5.1.1. Congestion control mechanism for packet loss

The purpose of this section is to present and analyse the experimental results of the congestion control mechanism of Skype video calls. The average and detailed results of the payload size, interarrival time and throughput of Skype video calls are represented below in Figs 3.5, 3.6 and 3.7.

Payload size

As represented in Fig. 3.5, the adjustments of the payload size in Skype video calls were similar across the three different motion types. Skype increased its average payload size from about 800 Bytes to 1000 Bytes when the packet loss rates increased from 0% to 8%. Furthermore, the average payload size was then significantly reduced to about 200 Bytes when the packet loss rate increased from 8% to 16%. Additionally, when the packet loss rate increased from 16% to 20%, Skype retained an average payload size that was stable at about

180 Bytes. Conversely, when the packet loss rate was suddenly released from 20% to 0%, the average payload size of Skype slowly increased. However, in spite of the strong similarity across these three motion types, the average payload size of video with fast motion did increase faster than with videos containing slow and medium motion. Because of these results, the video motion did slightly impact the adjustment of the payload size in instances where the packet loss rate was suddenly released.

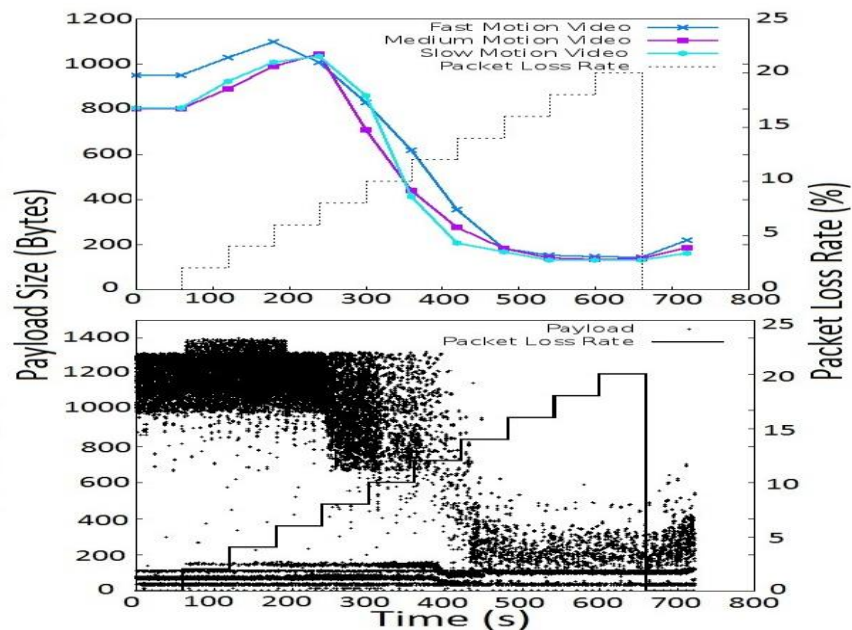

Figure 0.5: Payload size of Skype video calls under different packet loss rates

Depending on the changes of the detailed payload size, Skype adjusted its payload size according to different categories of packet loss rates, and especially for the packets that contained I frame.

- **Category 1: [0%, 6%].** In this category, Skype would maintain the range of payload sizes as unchanged. However, when the packet loss rate was between 2% and 6%, payload sizes of some I frame packets were between 1300 Bytes and 1400 Bytes. The reason for this is that Skype used FEC to recover the lost packets.

- **Category 2: [6%, 14%].** In this case, Skype enlarged the scope of payload sizes of I frame packets from [1000 Bytes, 1300 Bytes] to [600 Bytes, 1300 Bytes]. The reason for this may be that Skype used several codecs to encode I frame packets. Furthermore, when the packet loss rate reached 14%, the range of payload sizes of I frame packets were significantly reduced from [600 Bytes to 1300 Bytes] to [100 Bytes, 300 Bytes].
- **Category 3: [14%, 20%].** When in this category, Skype kept the payload size unchanged within the range of 100 Bytes to 300 Bytes

Interarrival time

As illustrated below in Fig. 3.6, the adjustments of inter-arrival time across the three videos containing different speeds of motion under different packet loss rates are similar. In considering this graph, as the packet loss rate reached 10%, Skype kept the interarrival time unchanged at between 0ms and 40ms. Conversely, when the packet loss rate was between 10% and 14%, Skype significantly increased interarrival time to about 40ms. Finally, when the packet loss rate increased from 14% to 20%, Skype maintained an inter-arrival time of around 60ms. However, when the packet loss rate was directly reduced to 0% from 20% directly, Skype did not appear to reduce interarrival time immediately.

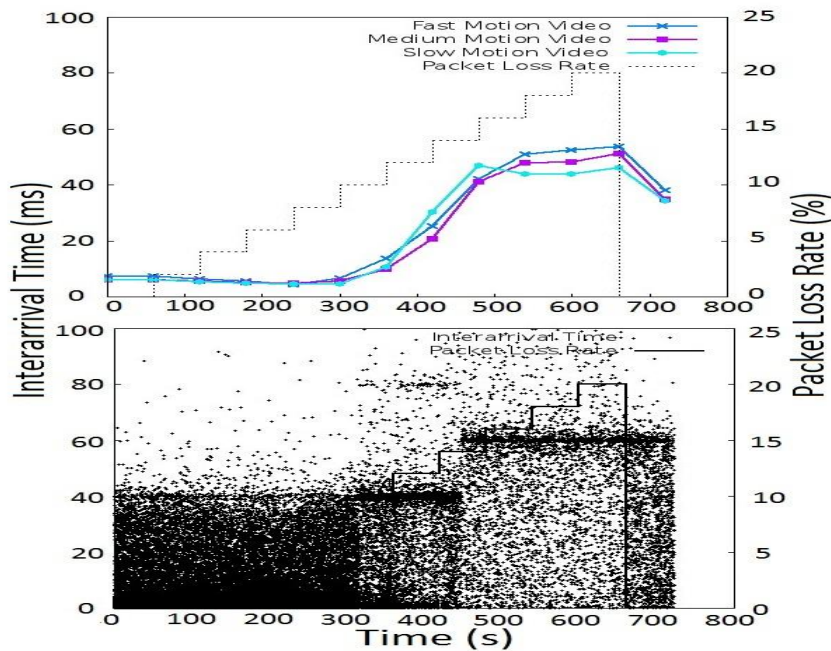

Figure 0.6: Interarrival time of Skype video call under different packet loss rates

According to the detailed results of this graph, Skype adjusted its payload size based on three categories of packet loss rates.

- **Category 1: [0%, 10%].** In this category, Skype maintained its interarrival times as unchanged, which were less than 40ms.
- **Category 2: [10%, 14%].** In this case, Skype sent most packets while using the interarrival time of around 40ms.
- **Category 3: [14%, 20%].** For this category, Skype revealed an interarrival time of around 60ms.

Throughput

As demonstrated below in Fig. 3.7, Skype appears to follow the same trend of adjusting the throughput of Skype video calls when running the videos containing different speeds of motion. Additionally, when the packet loss rate increased from 0% to 8%, Skype significantly increased its average throughput from about 1000 Kbps to 1700 Kbps. However, when the packet loss rate was between 8% and 14%, the throughput was dramatically reduced from about 1700 Kbps to 100 Kbps. Following these results, Skype then kept the throughput

unchanged at around 100 Kbps as the packet loss rate was increased from 14% to 20%. Conversely, when the packet loss rate was suddenly released from 20% to 0%, the throughput of Skype was slightly increased.

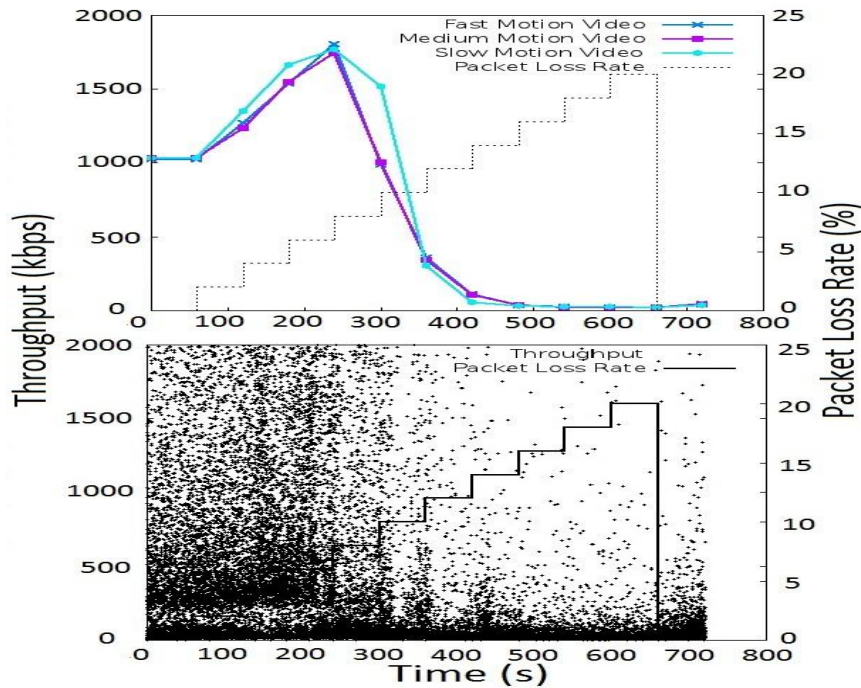

Figure 0.7: Throughput of Skype video calls under different packet loss rates

According to the detailed results above, it is clear that Skype adjusted its throughput based on three categories.

- **Category 1: [0%, 8%].** Under this category, while Skype used a wide range of throughput, the dominant throughput was between 250 Kbps and 500 Kbps.
- **Category 2: [8%, 14%].** In this case, most of the packets were sent by using throughputs of around 200 Kbps.
- **Category 3: [14%, 20%].** In this category, the throughput of most packets was around 100 Kbps

3.5.1.2. Congestion control mechanism for available bandwidth

This subsection will analyse how Skype adjusts the payload sizes, inter-arrival times and available bandwidth of Skype video calls according to different levels of video motion and under different levels of available bandwidth.

Payload size

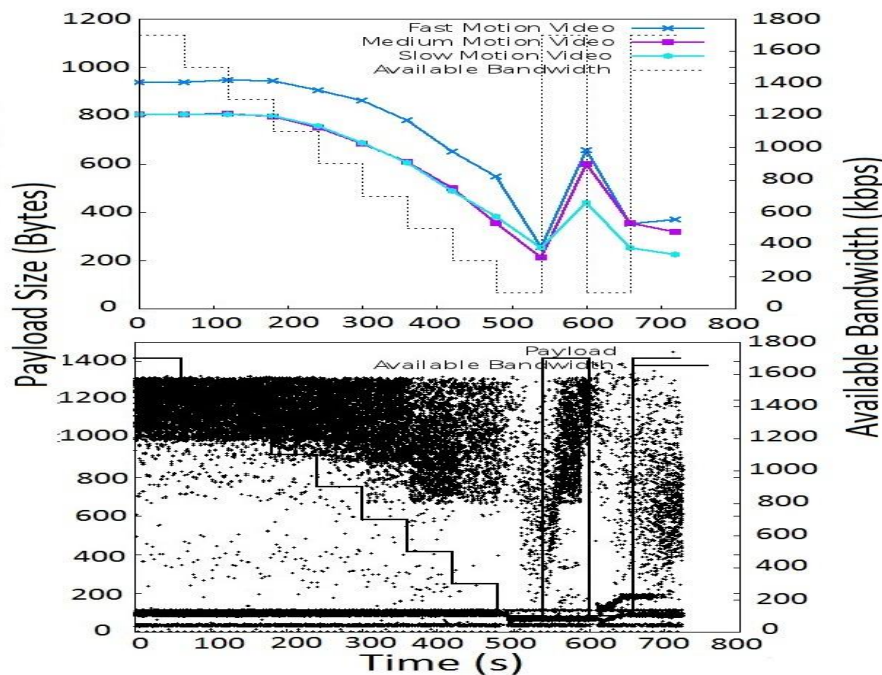

Figure 0.8: Payload size of Skype video calls under different available bandwidth

As demonstrated below in Fig 3.8, as the available bandwidth was decreased from 1700 Bytes to 100 Bytes, Skype followed the same trend to decrease the payload sizes. According to the detailed results of this graph, the adjustments of payload sizes made according to the available bandwidth were similar to the changes made under packet loss rates in Figure 5, with the exception of Category 2. Furthermore, Skype enlarged the scope of I frame packets from [1000, 1300] to [700, 1300]. Upon closer analysis, in the first square wave change (when available bandwidth was suddenly increased from 100 Kbps to 1700 Kbps), Skype significantly increased its payload size. Furthermore, Skype increased its payload size for the videos with fast and medium motion more rapidly than with the video containing slow motion.

Also, in the second square wave change, Skype increased its payload size at a slow rate than the one in the first square wave change.

Interarrival time

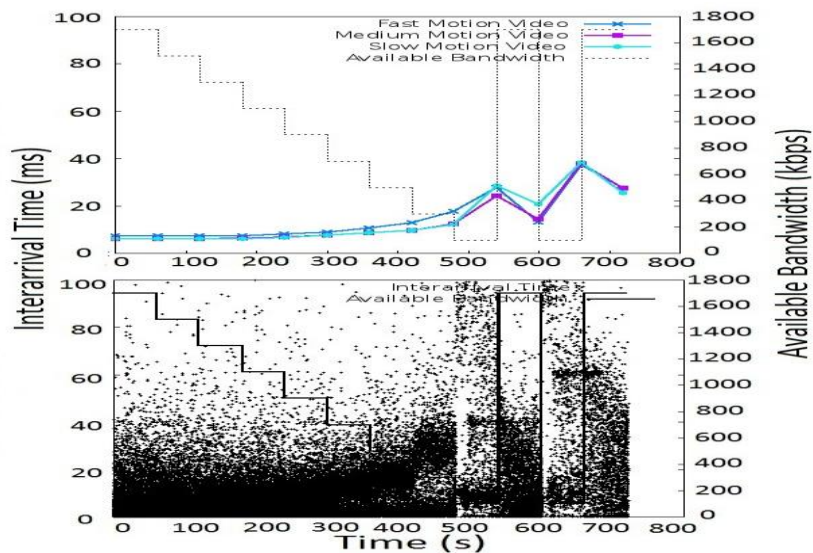

Figure 0.9: Interarrival time of Skype video calls under different available bandwidth

As shown in Fig. 3.9, the trends of interarrival time adjustments made by Skype video calls with different speeds of video motion were similar. Overall, when the available bandwidth was reduced from 1700 Kbps to 500 Kbps, the average interarrival times were unchanged at about 10ms. Furthermore, Skype then increased average interarrival time from about 10ms to 20ms when available bandwidth was decreased from 500 Kbps to 100 Kbps. During the square wave change in available bandwidth, the average interarrival time at 660 Seconds was higher than the average interarrival time at 540 Seconds. Moreover, based on the detailed results, the increase of the interarrival time in the first square wave change was demonstrated to be higher than that in the second square wave change.

As shown in Fig. 3.9, the trends of interarrival time adjustments made by Skype video calls with different speeds of video motion were similar. Overall, when the available bandwidth was reduced from 1700 Kbps to 500 Kbps, the average interarrival times were unchanged at about 10ms. Furthermore, Skype then increased average interarrival time from about 10ms to

20ms when available bandwidth was decreased from 500 Kbps to 100 Kbps. During the square wave change in available bandwidth, the average interarrival time at 660 Seconds was higher than the average interarrival time at 540 Seconds. Moreover, based on the detailed results, the increase of the interarrival time in the first square wave change was demonstrated to be higher than that in the second square wave change.

As shown in Fig. 3.9, the trends of interarrival time adjustments made by Skype video calls with different speeds of video motion were similar. Overall, when the available bandwidth was reduced from 1700 Kbps to 500 Kbps, the average interarrival times were unchanged at about 10ms. Furthermore, Skype then increased average interarrival time from about 10ms to 20ms when available bandwidth was decreased from 500 Kbps to 100 Kbps. During the square wave change in available bandwidth, the average interarrival time at 660 Seconds was higher than the average interarrival time at 540 Seconds. Moreover, based on the detailed results, the increase of the interarrival time in the first square wave change was demonstrated to be higher than that in the second square wave change.

As shown in Fig. 3.9, the trends of interarrival time adjustments made by Skype video calls with different speeds of video motion were similar. Overall, when the available bandwidth was reduced from 1700 Kbps to 500 Kbps, the average interarrival times were unchanged at about 10ms. Furthermore, Skype then increased average interarrival time from about 10ms to 20ms when available bandwidth was decreased from 500 Kbps to 100 Kbps. During the square wave change in available bandwidth, the average interarrival time at 660 Seconds was higher than the average interarrival time at 540 Seconds. Moreover, based on the detailed results, the increase of the interarrival time in the first square wave change was demonstrated to be higher than that in the second square wave change.

As shown in Fig. 3.9, the trends of interarrival time adjustments made by Skype video calls with different speeds of video motion were similar. Overall, when the available bandwidth

was reduced from 1700 Kbps to 500 Kbps, the average interarrival times were unchanged at about 10ms. Furthermore, Skype then increased average interarrival time from about 10ms to 20ms when available bandwidth was decreased from 500 Kbps to 100 Kbps. During the square wave change in available bandwidth, the average inter-arrival time at 660 Seconds was higher than the average interarrival time at 540 Seconds. Moreover, based on the detailed results, the increase of the interarrival time in the first square wave change was demonstrated to be higher than that in the second square wave change.

As shown in Fig. 3.9, the trends of interarrival time adjustments made by Skype video calls with different speeds of video motion were similar. Overall, when the available bandwidth was reduced from 1700 Kbps to 500 Kbps, the average interarrival times were unchanged at about 10ms. Furthermore, Skype then increased average interarrival time from about 10ms to 20ms when available bandwidth was decreased from 500 Kbps to 100 Kbps. During the square wave change in available bandwidth, the average interarrival time at 660 Seconds was higher than the average interarrival time at 540 Seconds. Moreover, based on the detailed results, the increase of the interarrival time in the first square wave change was demonstrated to be higher than that in the second square wave change.

Throughput

As shown in Fig. 3.10, the trends in adjustment of throughput in response to the three levels of video motion were similar. Here, it was found that Skype reduced throughput from about 1000 Kbps to about 90 Kbps when available bandwidth was decreased from 1100 Kbps to 100 Kbps. Furthermore, Skype never consumed all the available bandwidth. In the first square wave change, Skype significantly increased the throughput from about 90 Kbps to 400 Kbps. However, during the second square wave change Skype did slightly increase the throughput. Furthermore, according to the detailed results as represented by the above figure,

the difference in the increase of throughputs between the two square wave changes was evident.

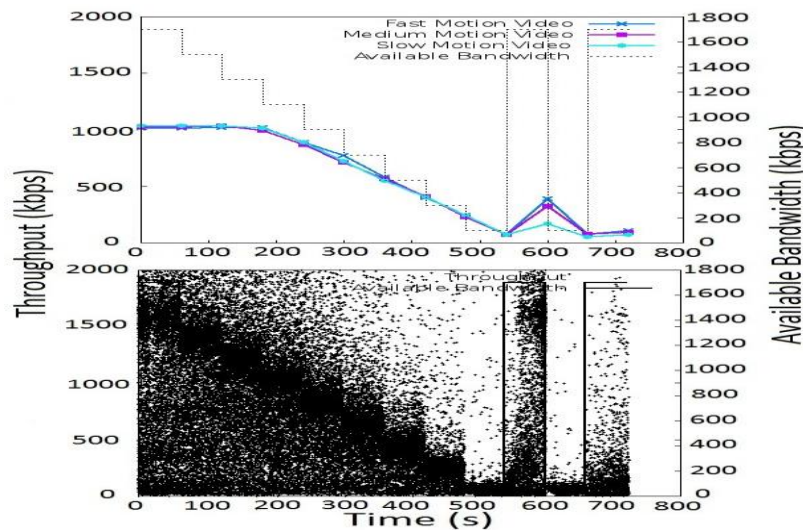

Figure 0.10: Throughput of Skype video call under different available bandwidth

3.5.2. QoE Analysis of Skype Video Calls

In this subsection, the QoE of Skype video calls under different packet loss rates and levels of available bandwidth will be analysed. Below, the results of QoE performance of Skype voice and video calls are shown in Fig. 3.11. According to these results, the QoE of Skype video calls degraded as the packet loss rate increased. Furthermore, when the packet loss rate remained between 0% and 8%, the QoE retained a good level. Conversely, when the packet loss rates were found to be between 16% and 20%, the QoE was comparably poor. Overall, while the trend of QoE degradation across the three Skype video calls was similar, the Skype video call containing fast motion was more affected than the videos containing the slower motion. Moreover, Skype video calls with slow motion were least affected by the packet loss. Also, when the packet loss rate was directly reduced to 0%, the QoE was able to recover slowly back to normal. Furthermore, when the packet loss rate was lower than 8%, the quality of Skype video calls was acceptable, hence why an 8% packet loss rate is considered the threshold for an acceptable quality of Skype video calls.

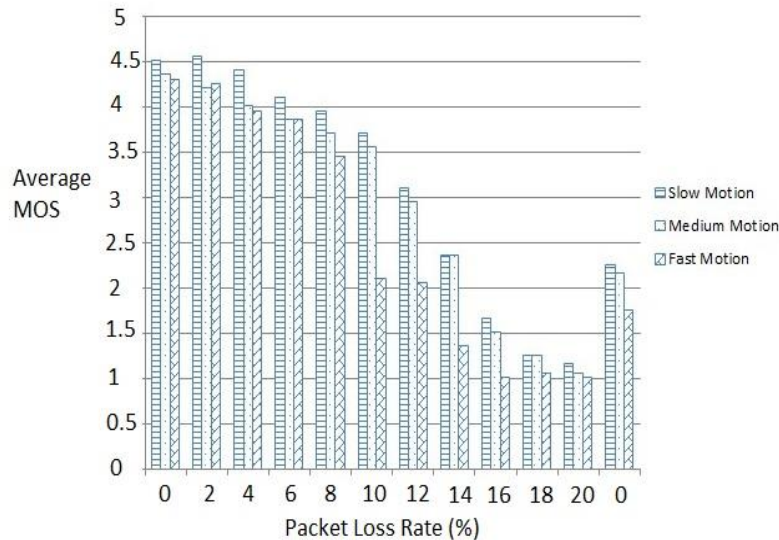

Figure 0.11: Average MOS of Skype video calls under different packet loss rates

3.6. Summary

Overall, the congestion control mechanisms of Skype for voice and video calls are similar as they adjust to the payload size, interarrival time and throughput according to the categories of packet loss rates. However, when Skype uses the FEC to recover the lost packets, it adopts a higher redundancy ratio for voice calls than with video calls. Furthermore, when packet loss is suddenly reduced, the Skype voice call would be able to quickly readjust the parameters back to their normal values. Moreover, Skype voice calls always use longer interarrival times to send several packets at same time (i.e. one packet contains several speech frames, thus longer interarrival time and more efficient use of network bandwidth), and adopt different interarrival times according to the category of packet loss rates. By contrast however, it seems that Skype video calls use the wide range of interarrival times to send packets only when packet loss rate is less than 10%. However, when the packet loss rate rises to higher than 10%, Skype video calls will increase its interarrival times to specific levels to send as many packets as possible. Also, when the packet loss rate is suddenly reduced from 20% to 0%, Skype readjusts its parameters back to their normal values faster in voice calls than with video call. Additionally, these results also revealed that video motion only slightly affects

congestion control mechanisms. Furthermore, as Skype video calls reduced their payload size and throughput, the increased interarrival time with available bandwidth was decreased.

In summary, this chapter investigated the congestion control mechanisms of Skype voice and video call, as well as the QoE of Skype voice and video calls under different packet loss rates and different levels of available bandwidth. Based on these results, Skype is able to quickly and efficiently detect to unstable network conditions and apply the appropriate action. Furthermore, the Skype congestion control mechanism adopts different methods for adjusting the parameters according to several categories of packet loss rates. In addition to these insights, the results also demonstrated that packet loss has more of an impact on the quality perceived by users than the available bandwidth. Additionally, it was also found that although one would intuitively assume video with faster motion to be more resource-demanding, the content of the video has almost no impact on the Skype congestion control mechanism. However, in spite of this consistency across the three motion types, the QoE of Skype video was shown to be significantly affected by the contents of the video. In addition to these other findings, these experiments also revealed that, when the packet loss rate is less than 10%, Skype was able to recover the QoE of voice and video calls effectively, and facilitated acceptable services for users. By contrast however, when the packet loss rate exceeded 8%, the quality of Skype video calls became unacceptable. However, in instances where congestion control mechanisms are unable to recover the QoE of mobile voice and video services, vertical handover may be a possible solution to recover the degradation of QoE of mobile voice and video services.

Chapter 4: QoE-driven Vertical Handover Algorithm

4.1. Introduction

In recent years, mobile users have increasingly used mobile video services over heterogeneous wireless networks. In conjunction with this trend, the QoE of mobile video services is becoming more important for mobile users than ever before. However, in spite of this growing demand, the existing vertical handover algorithms, mainly based on QoS parameters for decision-making, are unable to provide and maintain QoE for mobile video services in heterogeneous wireless networks. As a solution to this dilemma, this chapter will introduce the proposed QoE-driven VHO algorithm. To structure this chapter: the reference-free QoE prediction model applied in the proposed algorithm is introduced in Section 4.2; Section 4.3 will present the details of a QoE-driven VHO algorithm; The performance evaluation of the proposed VHO algorithm in comparison with the existing bandwidth-based algorithm will then be discussed in Section 4.4; and lastly, Section 4.5 will summarise the key points of this chapter.

4.2. QoE Prediction Model

As discussed in Chapter 3, while the QoE of mobile video services can be affected by network impairment, it is also important to consider that it is also dependent on the video content. As such, it is necessary to include network impairments and video content types in the measurements of QoE in mobile services when creating a QoE-driven VHO algorithm. Furthermore, a reference-free video QoE prediction model is applied in the QoE-driven VHO algorithm to predict QoE of mobile video services [100]. This QoE prediction model predicts the QoE of mobile video services based on Packet Error Rate (PER), the video content type and the video application parameters which include Frame Rate (FR) and Sender Bitrate

(SBR). The equation of this QoE prediction model [100] is shown as equation below Eq. (4.1):

$$MOS = \frac{a1+a2FR+a3\ln(SBR)}{1+a4PER+a5(PER)^2} \quad (4.1)$$

In this model, the type of video content is classified into three types based on the motion of video content, i.e. Slow Movement (SM), General Walking (GW) and Rapid Movement (RM). The coefficient metrics (a1 to a5) for three different content types were obtained by nonlinear regression analysis and are shown below in Table 4.1 [100].

Table 4.1: Coefficient metrics of all types of video

Coeff	SM	GW	RM
a1	2.797	2.273	-0.0228
a2	-0.0065	-0.0022	-0.0065
a3	0.2498	0.3322	0.6582
a4	2.2073	2.4984	10.0437
a5	7.1773	-3.7433	0.6865

There is a point to discuss that this QoE predict model defines three type of video with different MOS values as PER is 0%. This model is applied to H.264 video with cif format. Due to the size of mobile screen and resolution size of cif format video, the SM video is easier to satisfy mobile users than the SM video with stable image and contents. Although the RM video also has clear details as the SM video, but the RM video could make mobile users tried to catch up all changing details with fast movement contents. Hence, it is understandable that the SM video could get higher satisfactions and better feedbacks than the RM video under same network conditions. Furthermore, this model is used to prove and validate the concept of QoE-driven VHO algorithm. With the revolution of video technology, mobile device and wireless network technology, the QoE prediction model also could be developed to provide more accurate QoE measurement for QoE-driven VHO algorithm.

To monitor the QoE of a mobile video service in real-time, this QoE prediction model is used to measure the QoE of the mobile video service and regularly generate MOS for the QoE-driven VHO algorithm. Thus, by using this model, the QoE-driven VHO algorithm is able to detect the degradation of QoE in the mobile video service and make a vertical handover decision in time according to the predicted MOS.

4.3. QoE-driven Vertical Handover Algorithm

The process of vertical handover is an important method for maintaining and enhancing the QoE of mobile video services in heterogeneous wireless networks. By consequence, the QoE of a mobile video service should be considered when designing and developing vertical handover algorithms. However, if a VHO algorithm were designed to persistently choose a network that provides the best QoE of mobile video services when in a heterogeneous wireless network, unnecessary network handover may occur between different available wireless network which cause oscillation between these networks. Furthermore, as the QoE of mobile video services also requires time to be recovered after VHO has occurred, unnecessary handover may also occur before the QoE recovery following the last VHO has completed. Because of this, there is a need to design an appropriate criterion and a safeguard period to satisfy the requirements of the mobile user on QoE in mobile video services while also avoiding unnecessary handover at the same time.

Overall, a QoE-driven VHO algorithm is designed to provide and maintain an acceptable QoE of mobile video services for mobile users over heterogeneous wireless networks. Depending on the quality requirements of telecommunication services, acceptable QoE is defined as the minimum threshold of acceptable quality, e.g. $MOS > 3.5$ [101, 102]. Furthermore, acceptable QoE is an appropriate threshold for a vertical handover algorithm to satisfy mobile users and avoid unnecessary handover at same time. Additionally, the QoE-

driven VHO algorithm applied two other functions to avoid unnecessary VHO: block list (BL) and minimum connecting time (MCT). BL is used to store information of the wireless networks that have been identified as too congested to provide an acceptable QoE of mobile video services. If a wireless network is listed in BL, this wireless network would be ignored by the VHO algorithm so that unnecessary VHO to a congested wireless network can be avoided. Also, MCT is designed to avoid the unnecessary VHO caused by another situation. In considering that the QoE of mobile video services require a short time-period to recover following vertical handover; this mean that, during this period, another handover decision could potentially be made to target another candidate wireless network and initiate VHO before the QoE recovering from the last VHO has returned to normal: In this instance, VHO is unnecessary as the QoE of mobile video service could have recovered from the previous VHO if there had been enough time. In response to this issue, MCT aims to ensure essential time for VHO to recover the QoE of mobile video services. This means that, throughout MCT, no candidate wireless networks will be considered for VHO to ensure that unnecessary VHO is avoided.

The QoE-driven VHO algorithm is implemented on the basis of the MIH standard. With the MIH standard, wireless network accessing points will regularly broadcast radio advertisement (RA) to inform mobile nodes (MNs) in heterogeneous wireless networks. Using this implementation, the QoE-driven VHO algorithm is designed to be activated only once an RA is received and not before: this is because, if no candidate wireless networks are available, performing the QoE-driven VHO algorithm constantly would other drain both battery and local processor resources unnecessarily. Furthermore, since the QoE of mobile video service need to be measured regularly in real time, the interval time between two measurements should be selected carefully to ensure the accuracy of predicted QoE performance. If the interval time was too long, the QoE of mobile video service could not be updated in time and

the network condition could be predicted better than the reality. Hence, QoE-driven VHO algorithm could not make handover decision in time to recover degraded QoE performance. Nevertheless, if the interval time was too short, the QoE performances could not be measured accurately, because the network condition could be predicted worse than the reality. Thus, the QoE-driven VHO algorithm might make wrong handover decision to initiate the handover when the QoE performance of mobile video services still were acceptable to mobile users. In order to select the appropriate interval time for QoE performance measurement, a packet buffer was designed to control the interval time of QoE performance measurement. Once the buffer is full, the network condition would be predicted and QoE of mobile video services would be measured. After more than 30 tests with different buffer size from 40 to 500, the network condition and QoE performance could be measured properly as buffer size was set to 100. Therefore, the QoE-driven VHO algorithm can make proper handover decision to recover unacceptable QoE of mobile video services. The flow process and pseudocode for the QoE-driven VHO algorithm are shown in Fig. 4.1 and Table 4.2.

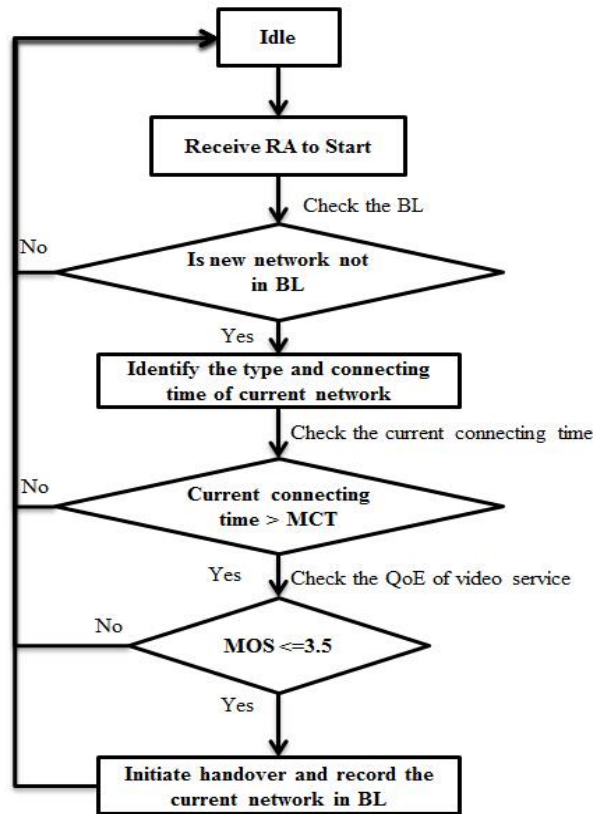

Figure 0.1: Process flows of the QoE-driven VHO algorithm

Table 4.2: Pseudocodes of the QoE-driven VHO algorithm

-
0. Idle and Waiting for new RA to start
 1. If receiving RA from connecting network
 2. Ignore this receiving RA back to Idle
 3. Else if receiving RA does not match any RA in BL
 4. Check the current connecting time
 5. Else stop and back to Idle
 6. If the current connecting time is longer than MCT
 7. Check the current QoE of video services
 8. Else stop and back to Idle
 9. If the current MOS is not more than 3.5
 10. Initiate the handover to new network and store the information of current connecting network into BL
 11. Else stop and back to Idle
-

As represented above in Fig. 4.1 and Table 4.2, as an MN receives an RA from the candidate network, the QoE-driven VHO algorithm is then activated. Firstly, the algorithm will check whether the candidate network has been recorded in BL. At this stage, if the candidate

network has been recorded in BL, the QoE-driven VHO algorithm will ignore this candidate network. Otherwise, the type and connecting time of the current network will then be identified for the next MCT check. After this stage, if the connection time of the current network is shorter than MCT, the QoE-driven VHO algorithm will ignore the candidate network. However, if the connection time of the present network is longer than MCT, the QoE-driven VHO algorithm will move forward to check the QoE of the multimedia service. After this step, and if the QoE of the present network is unacceptable (i.e. MOS less than 3.5), the QoE-driven VHO algorithm network will initiate handover to this candidate network and record the presently connected network in BL. However, when the current QoE is deemed acceptable, the QoE-driven VHO algorithm will ignore this candidate network. Overall, by applying functions of acceptable QoE, BL and MCT, QoE-driven, the VHO algorithm can provide and maintain acceptable a QoE of mobile video services when delivered over a heterogeneous wireless network. Furthermore, the performance evaluation of the QoE-driven VHO algorithm over UMTS and WiFi networks will be covered in the next section.

4.4. Performance Evaluation

4.4.1. Simulation Design and Topology

As part of this performance evaluation, Network Simulator 2.29 (NS 2.29) is used to simulate a multimedia service over heterogeneous wireless networks. Here, NS 2.29 is integrated with the MIH standard to support seamless VHO between the UMTS network, the WiFi network and the WIMAX network. In this simulation, the performance of the proposed QoE-driven VHO algorithm will be evaluated over the UMTS network and WiFi network. Furthermore, the comparison between a QoE-driven VHO algorithm and the default MIH bandwidth-based VHO algorithm will be conducted over the UMTS and WiFi network. In order to evaluate the performance of the QoE-driven VHO algorithm, three wireless networks, including one UMTS network and two WiFi networks, will be incorporated into the simulation.

Furthermore, two WiFi networks will be implemented in the coverage of the UMTS network. For this, there is one RNC (Radio Network Controller) and one UMTS base station (BS) to provide the UMTS network. In each WiFi network, there is a WiFi AP to provide the WiFi network. Additionally, a UMTS interface and a WiFi interface are implemented in a MN as a multi-interface MN. Because of this, the MN is able to connect to the UMTS and WiFi network. Also, a video server is used to provide a video service for the MN. Furthermore, to evaluate whether a QoE-driven VHO algorithm could maintain an acceptable QoE of different types of video, SM reference video – Akyio and RM reference video – Football are used to generate two types of sending video, and each type of sending video will run for a duration of 120 seconds. Additionally, a router is used in this simulation to connect between three networks and the video server. The topology of this simulation is depicted in Fig. 4.2.

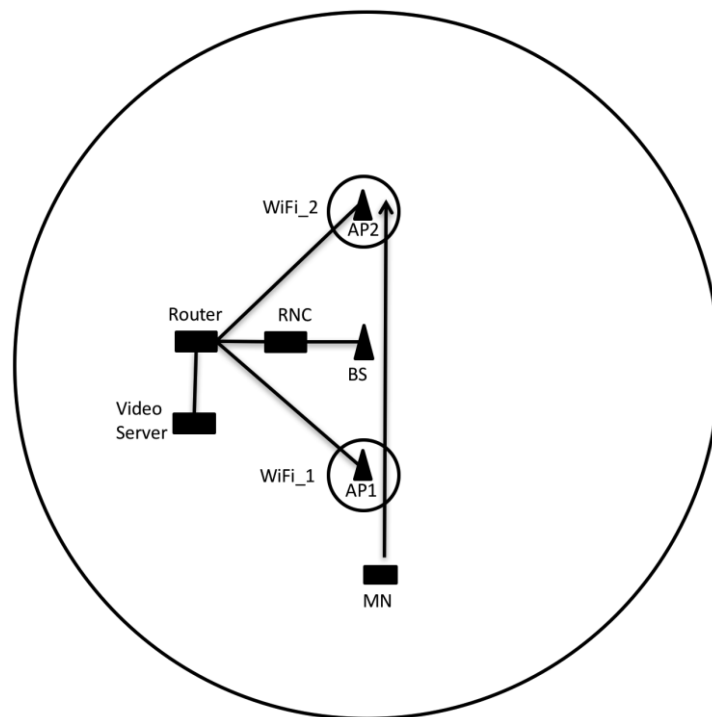

Figure 0.2: Simulation Topology

Furthermore, the process of this simulation is designed so that the multi-interface MN is connected to the UMTS network at the beginning of the simulation. At the beginning of

simulation, the MN stays within the coverage of UMTS network, and then will go straight towards the destination in the WiFi_2 network at a speed of 2 m/s. Before the MN approaches the coverage of the WiFi_2 network, it will enter the coverages of the WiFi_1 network. After this has occurred, the MN will then leave the coverage of the WiFi_1 network and move forward to the WiFi_2 network. The UMTS network is defined as a background network that will not be recorded in BL. Overall, this simulation will last a duration of 180 seconds and the video server will start to send the video to multi-interface MN at the 20th second. Furthermore, in order to test how the QoE-driven VHO algorithm will cope with the minor PER and react to the change in network conditions, the conditions of the three networks are defined according to the following: For the WiFi_1 network, the PER of WiFi_1 network is set to 1% when starting of the simulation; and the PER of the WiFi_1 network will be reset to 10% at 60th seconds. Additionally, the PER of UMTS network will be set to 0% and the PER of the WiFi_2 network will be set to 1% from the beginning to the end of the simulation. When the simulation begins, the MN will connect to the UMTS network as the background network. Then, when the MN moves into a WiFi network, the MN will connect to the WiFi network automatically. In this experiment, the MN will move into the coverage of WiFi_1 network at around the 38th second, and leave at around the 100th second. During these periods, the network condition will become more difficult for testing the QoE-driven VHO algorithm and the bandwidth-based VHO algorithm. Following this, at about the 115th second, the MN will then enter the coverage of the WiFi_2 network and remain within the coverage of the WiFi_2 network until the end of the simulation. In this simulation, the default MIH bandwidth-based VHO algorithm will be used to compare with the QoE-driven VHO algorithm. Furthermore, the trace of the data of input video and output video will be monitored and compared to generate QoS results and QoE results in terms of

both QoS parameters and MOS. Below, the network parameters and video parameters are illustrated in Table 4.3.

Table 4.3: Simulation Parameters

Parameters	Wireless Technology		
	<i>UMTS</i>	<i>WiFi_1</i>	<i>WiFi_2</i>
Coverage Aera	500 m	50 m	50 m
Bandwidth	1 Mbps	11 Mbps	11 Mbps
Packet Error Rate	0%	1% and 10%	1%
Parameters	Multi-interface MN		
Speed	2 m/s		
Parameters	SM Video	RM Video	
Video Frames	3000	3000	
Frame Rate	25	25	
Sender Bitrate	240 Kbps	640 Kbps	

4.4.2. Results Analysis

In this section, the QoS and QoE performance of the QoE-driven and bandwidth-based VHO algorithms will be presented and analysed based on the simulation results. Additionally, the average PER of the SM video and RM video are depicted in Fig. 4.3 and 4.4 below.

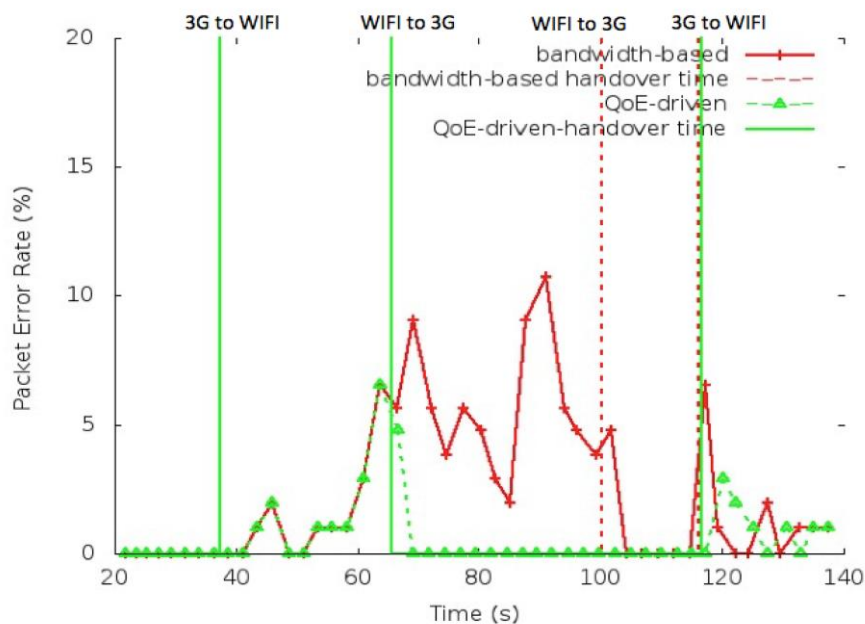

Figure 0.3: Average PER of SM video

As represented in Fig. 4.3 above, during the period in which the SM video was being sent from the video server to the multi-interface MN, the QoS performance of the QoE-driven VHO algorithm was better than the bandwidth-based VHO algorithm. Additionally, the QoE-driven VHO algorithm maintained a lower average PER for the SM video service than the bandwidth-based VHO algorithm. Furthermore, when the MN switched connection over the WiFi_1 network, the average PER slightly increased. At the moment this occurred, even when there was a minor PER in the WiFi_1 network, the QoE-driven VHO algorithm still decided to persist connecting to WiFi_1 instead of initiating handover to UMTS, as the QoE of the SM video still was acceptable under minor PER. Following this, when the PER dramatically augmented after the 60th second, QoE-driven VHO algorithm made the handover decision to switch video stream to the UMTS network immediately. Because of this, the QoE-driven VHO algorithm avoided congestion in the WiFi_1 network. However, while the average PER did reach about 10%, the bandwidth-based VHO algorithm still decided to connect to the WiFi_1 network rather than initiate handover to UMTS. Additionally, in reviewing the reconstructed video, the QoE of the video deteriorated to an unacceptable level for users when PER increased to about 8%. When the MN entered the coverage area of WiFi_2 network, both of QoE-driven VHO algorithm and the bandwidth-based VHO algorithm switched video stream to the WiFi_2 network and remained in the WiFi_2 network.

The average PER of RM video is shown above in Fig. 4.4. When compared to Fig. 4.3, the bandwidth-based VHO algorithm still decided to remain in the WiFi_1 network as the PER increased dramatically. However, as RM video was more sensitive to PER than SM video, the QoE-driven VHO algorithm switched the video stream connection to the UMTS network before PER began to rise significantly. Furthermore, as WiFi_1 was recorded in BL, even though the MN still was in the coverage area of the WiFi_1 network and continued to receive the RA from the WiFi_1 network, the QoE-driven VHO algorithm simply ignored the

WiFi_1 network and continued to connect to the UMTS network. After the MN left the coverage of the WiFi_1 network and moved into the WiFi_2 network, the multi-interface MN first connected to the WiFi_2 network. Nevertheless, unlike SM VIDEO, the QoE of SM VIDEO fell to an unacceptable level over the WiFi_2 network. Because of this, the QoE-driven VHO algorithm decided to quickly initiate handover to UMTS once the QoE-driven VHO algorithm detected that the current QoE of the RM video was unacceptable to users. However, the bandwidth-based VHO algorithm treated the RM video the same as SM video that still decided to maintain the connection of the RM video on the WiFi_2 network. Here, it is clear that the QoE-driven VHO algorithm made a better VHO decision than the bandwidth-based VHO algorithm in reacting to the change in network conditions. Moreover, the QoE-driven algorithm also took the video content into account as the handover decision was made.

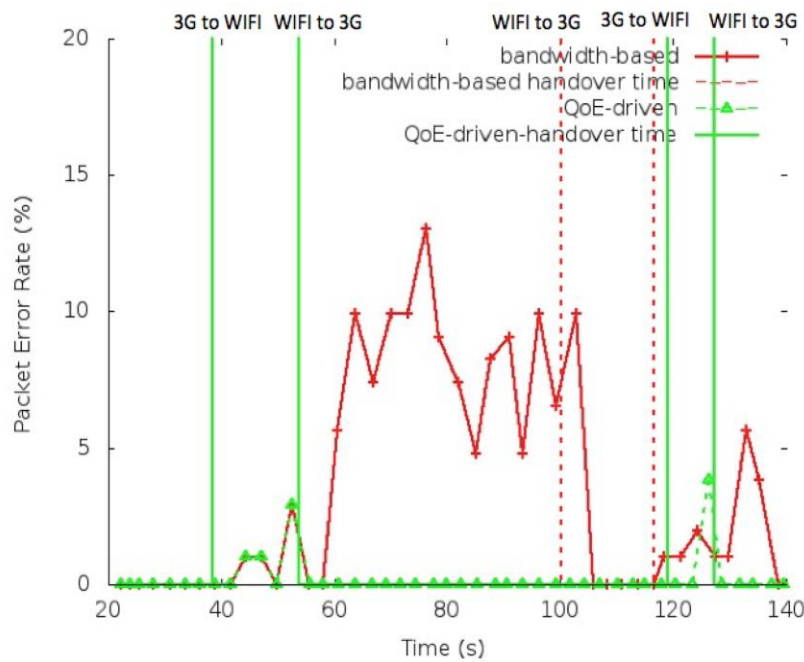

Figure 0.4: Average PER of RM video

Below, the QoE performance of SM video and RM video with the QoE-driven VHO algorithm and bandwidth-based VHO algorithm are shown as Fig. 4.5 and Fig. 4.6. As represented in Fig. 4.5, as the MN connected to the WiFi_1 network for around 38 seconds, the QoE of the video service started to slightly degrade. In this case, even though there was

minor PER in the WiFi_1 network, the MOS that was still more than 3.5 meant that the quality of SM video was acceptable to users. Because of this, the QoE-driven VHO algorithm decided to continue connecting to the WiFi_1 network. Additionally, the bandwidth-based VHO algorithm decided to maintain the connection with the WiFi_1 network. Then, after the 60th second, the network condition degraded and the MOS of the SM video dramatically decreased. After this occurred, once the MOS became less than 3.5, the QoE-driven VHO algorithm decided to switch the video stream connection to the UMTS network. Additionally, by checking the BL, the WiFi_1 network was ignored by the QoE-driven VHO algorithm even while WiFi_1 was still available. In this case, there was still no need to connect to the WiFi_1 network again, as the network condition would still not be good enough to deliver the video service at an acceptable QoE, only for the QoE-driven VHO algorithm to handover the video stream back to the UMTS network again. Such unnecessary handovers would consume additional power from the MNs and place additional burden network provider resources.

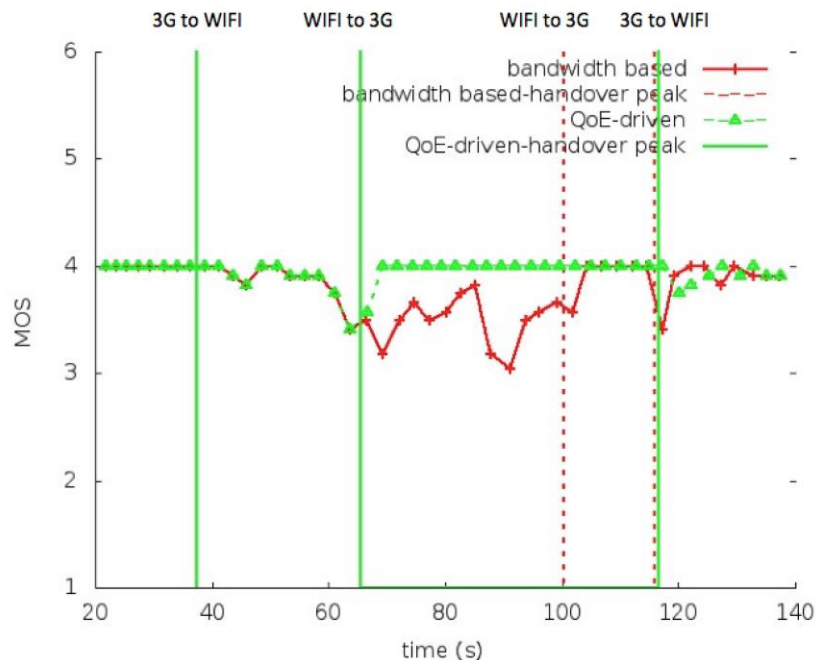

Figure 0.5: QoE performance of SM video

However, when the network condition of WiFi_1 network turned bad, the bandwidth-based VHO algorithm still decided to remain connected to the WiFi_1 network until leaving the

coverage area of the WiFi_1 network, and even as the quality of the video service decreased and became unacceptable to the users. Furthermore, when the MN entered the coverage of the WiFi_2 network, the MN connected to the WiFi_2 network automatically. Additionally, even though there were minor packet errors in the WiFi_2 network, the MOS of SM video was still above 3.5, which meant that the QoE of SM video was acceptable to users. Due to these indications, both the QoE-driven VHO algorithm and bandwidth-based VHO algorithm decided to remain connected to the WiFi_2 network until the simulation had ended.

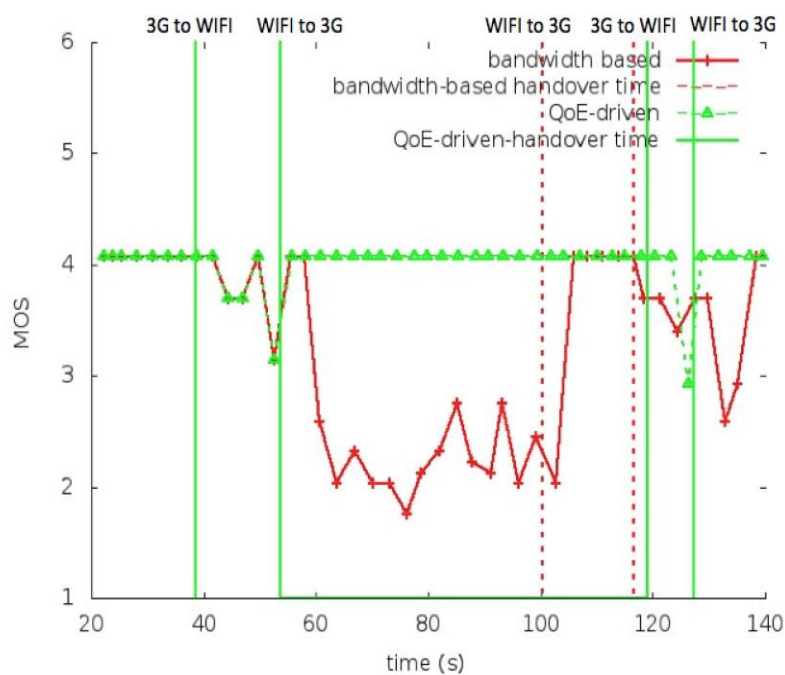

Figure 0.6: QoE performance of RM video

As shown in Fig. 4.6, as the RM video was more sensitive to packet errors than SM video, the QoE of the RM video had become unacceptable before the network condition of the WiFi_1 network had deteriorated at the 60th second. Because of this, the QoE-driven VHO algorithm made the decision to activate handover to the UMTS network immediately once the MOS of the RM video became less than 3.5. However, even as the MOS of the RM video was reduced to nearly 2 after by 60th second, the bandwidth-based VHO algorithm still continued to connect to the WiFi_1 network until the MN had left the coverage of the WiFi_1 network. In

this case, the QoE of RM video became perceivably poor and unacceptable to users, and the users would have been disappointed with the quality of the RM video. Furthermore, when the MN moved into the coverage of the WiFi_2 network, the QoE-driven VHO algorithm also quickly made the handover decision to switch the RM video stream to the UMTS network and maintain acceptable QoE for users, once the MOS had been reduced to less than 3.5. Additionally, the bandwidth-based VHO algorithm still decided to continue connecting to the WiFi_2 network until the end of this simulation and the QoE-driven VHO algorithm was able to maintain acceptable QoE for users even when the network conditions deteriorated. Furthermore, the QoE-driven VHO algorithm makes the handover decision based on the MOS that can reflect the QoE of the video service regardless of the video type. However, the bandwidth-based VHO algorithm is unable to maintain acceptable QoE for users as the network deteriorates. Moreover, as bandwidth-based made handover decisions are only based on the bandwidth of the network without considering the type of the video content, RM video is treated just the same as SM video.

In order to identify the overall QoE performance of SM and RM video, the average MOSs of overall SM and RM video service are represented in Table 4.4. According to these results, it is evident that a QoE-driven VHO algorithm can provide better QoE than a bandwidth-based VHO algorithm. Furthermore, even though RM video was much more easily affected by packet errors and more difficult to sustain its QoE than with SM video, the QoE-driven VHO algorithm was able to maintain the QoE of RM video efficiently and make the handover decision quickly based on the MOS. Furthermore, for SM video, both the QoE-driven VHO algorithm and the bandwidth-based VHO algorithm were able to maintain an acceptable overall level of QoE performance. However, in reviewing these results, it was only the QoE-driven VHO algorithm that was able to maintain acceptable overall QoE performance for RM video. Additionally, the bandwidth-based VHO algorithm was unable to maintain acceptable

QoE performance for RM video. Given this result, this is why it is important to consider the video content in the handover decision. On the basis of these results, it also appears that a QoE-driven VHO algorithm can maintain an acceptable QoE for mobile video services for all types of video content.

Table 4.4: Average MOS of overall SM and RM Video

	SM	RM
QoE-driven VHO Algorithm	3.95	4.01
Bandwidth-based VHO Algorithm	3.80	3.30

4.5. Summary

Overall, the QoE-driven VHO algorithm is designed to make the handover decision based on the MOS and prioritise maintaining an acceptable QoE in mobile video services for the user. Furthermore, the QoE-driven VHO algorithm applies BL and MCT functions to avoid handover that is unnecessary. Moreover, since the QoE-driven VHO algorithm takes the type of video content into consideration, this algorithm can make a handover decision accurately and rapidly, and maintain acceptable QoE of mobile video services with different types of video content. To assess this algorithm, the performance evaluation of the QoE-driven VHO algorithm was carried out in NS 2.29: According to these results, it was demonstrated that the QoE-driven algorithm was able to effectively maintain an acceptable level of QoE for both SM and RM video. Furthermore, when compared with the bandwidth-based VHO algorithm, the QoE-driven VHO algorithm was able to detect the degradation in QoE of mobile video services and therefore make the handover decision earlier than the point at which the network would become perceivable worse for the user. Hence, the QoE-driven VHO algorithm provided and maintained a better QoE in the mobile video service than that of the bandwidth-based VHO algorithm.

In summary, the QoE-driven VHO algorithm can provide and maintain acceptable QoE in mobile video services for mobile users. However, despite these promising results, there is still a question that needs to be considered: Is an acceptable QoE enough to satisfy the actual requirements of the mobile user? Although this QoE-driven VHO algorithm can satisfy the mobile users who are concerned with the QoE of mobile video services, some users may prioritise other criteria such as cost-free access according to detectable preferences of the mobile user. Therefore, as perceived quality of the consumed mobile content may not be the only possible criterion, the QoE-driven VHO algorithm may not be sufficient if the users prefer sacrifice quality to reduce cost as a preference. This possibility motivated our work on user-centric QoE-driven (UCQoE) VHO management framework and will be the focus in the next Chapter. Furthermore, the evaluation results showed that the QoE-driven VHO algorithm can effectively maintain QoE of mobile video services while mobile devices roamed between two WiFi networks. Thus, there is no need to repeat the evaluation on multi-WiFi scenarios in next stage. The evaluation of UCQoE VHO management framework should be designed to validate that whether the framework could maintain QoE performance of video services under different network conditions in single WiFi network and consider mobile users' different requirements at same time. The UCQoE VHO management framework will be introduced and evaluated in next chapter.

Chapter 5: User-centric QoE-driven Vertical Handover

Management Framework

5.1. Introduction

For most regular mobile users, there is a lack of understanding of what occurs in a wireless network when the QoE of a mobile video service degrades. What mobile users concern most are the cost and the QoE of mobile video services. However, while cost may play a significant role for the user at most times, a mobile user may have different requirements for mobile video services in different situations. In Chapter 4, a QoE-driven VHO algorithm was designed to provide and maintain acceptable QoE of mobile video services for mobile users in a heterogeneous wireless network. However, in spite of this improving the mobile user experience, this QoE-driven VHO algorithm is still not able to satisfy the mobile user with different requirements for mobile video services that are able to change at different times. Furthermore, not any single VHO algorithm is able to fulfil the different requirements of the mobile user at each different time. Because of this, to ensure that users are satisfied at all times, it is necessary to consider the actual requirements of the mobile users as a handover decision is made. In response to this need, this chapter will introduce a user-centric QoE-driven (UCQoE) VHO management framework for making the handover decision based on the actual requirements of the mobile user for mobile video services. Additionally, the structure and performance evaluation of the basic UCQoE VHO management framework will be presented in Section 5.2 and 5.3. To structure this chapter, Section 5.4 will introduce an advanced UCQoE VHO management framework which further considers the primary QoE requirements; the performance of the advanced UCQoE VHO management framework will be evaluated in Section 5.5; the financial impacts of the UCQoE VHO management will be

investigated in Section 5.6; and lastly, this chapter will be concluded in Section 5.7 by summarising the chapter outcomes.

5.2. Basic UCQoE VHO Management Framework

A basic user-centric QoE-driven (UCQoE) VHO management framework is designed to manage different VHO algorithms to satisfy mobile users based on the actual requirements of the mobile user that can vary at different times.

The basic UCQoE VHO management framework is based on the MIH framework that is able to provide seamless VHO for mobile video services in heterogeneous networks. To acquire the actual requirements for mobile video services of the mobile user, this framework applies a user preference function for mobile users to set based on their actual requirements. Furthermore, to satisfy the different requirements for mobile video services of mobile users, this UCQoE VHO management framework applies two VHO algorithms to maintain the QoE of mobile video services based on the actual requirements of the mobile user. To illustrate this, the structure of the basic UCQoE VHO management framework is shown below in in Fig. 5.1.

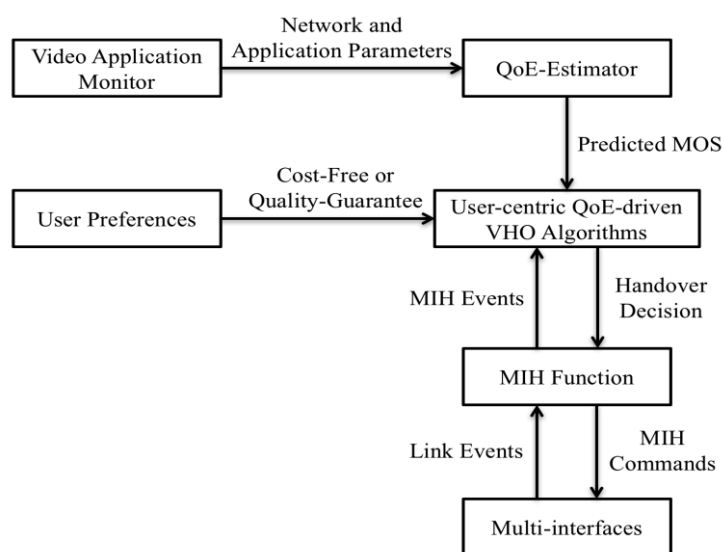

Figure 0.1: Structure of basic UCQoE VHO management framework

In basic UCQoE VHO management framework, five main components are included: Video Application Monitor, QoE-Estimator, the Users' Preferences Function, User-centric QoE-driven VHO Algorithms and the MIH Function. Using this framework, the video application monitor will regularly measure network parameters (e.g. the packet loss rate and bandwidth), and then send the results and application parameters (e.g. FR and SBR) to QoE-Estimator for QoE prediction. After this has occurred, the QoE-Estimator then applies the reference-free QoE prediction model to estimate the QoE of the mobile video services according to the information extracted from application services and network parameters. Following this stage, the predicted MOS will be sent to the user-centric QoE-driven VHO algorithms to make the handover decision. In this framework, the user preferences function is used to obtain the actual requirements of the mobile user on cost or the QoE of mobile video services. In the user preference function, there are two options that users can select: Cost-Free and Quality Guarantee. Furthermore, depending on the options in user preferences, there are two corresponding QoE-driven VHO algorithms used to make the handover decision: the QoE-driven VHO algorithm and the network-based VHO algorithm. Once the handover decision has been made, the handover decision will be sent to the MIH function to initiate vertical handover to target wireless network candidate. Additionally, the MIH function is also used to gather information from the network interfaces and generate MIH events to initiate the VHO handover algorithms.

Within the basic UCQoE VHO management framework, two different kinds of requirements for the QoE of the mobile video services are considered: If the mobile user prefers free a WiFi network, they are able to set user preferences to Cost-Free. Using this set preference, the network-based VHO algorithm would be applied to make handover decisions that prioritise free WiFi network access when available. Conversely, when mobile users are concerned primarily with the QoE of mobile video services rather than the cost of mobile

data, a QoE-driven VHO algorithm is applied to maintain an acceptable QoE of mobile video services for the mobile user irrespective of the additional data consumed. Due to this ability to customise according to these two likely preferences, the basic UCQoE VHO management framework is able to satisfy the two actual requirements for QoE of mobile video services at different times for the mobile user. Additionally, the process flow diagram depicting the basic UCQoE VHO management framework is illustrated in Fig. 5.2.

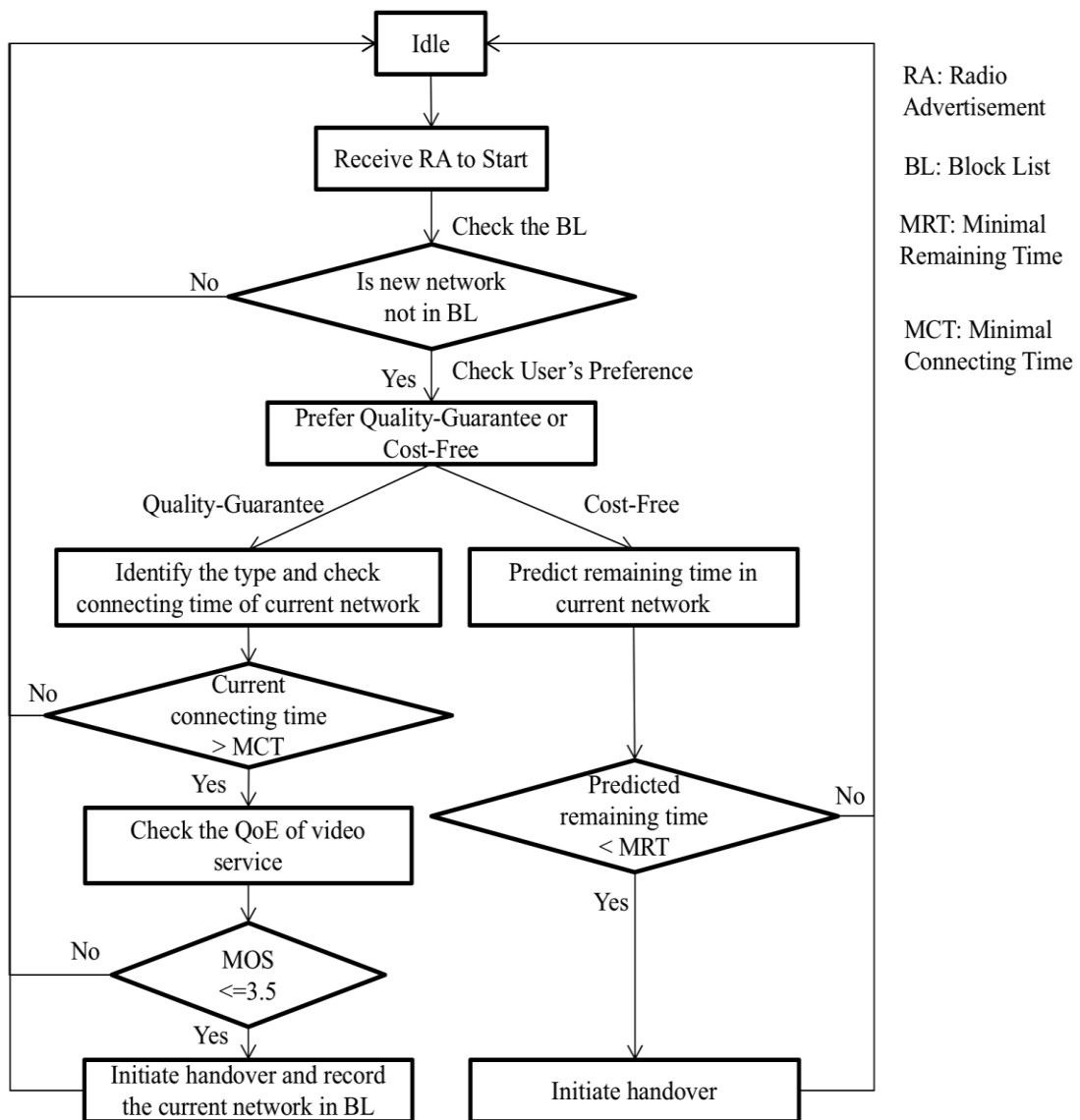

Figure 0.2: Process flows of basic UCQoE VHO management framework

In reviewing this process flow chart, it is noted that the basic UCQoE VHO management framework is set to connect to new a new WiFi network automatically when users are using a mobile network. The reason for this is that WiFi networks most often provide free network access services with high bandwidth for mobile users. Here, once the basic UCQoE VHO management framework is notified of the MIH event of receiving a radio advertisement (RA), it will checks the block list (BL) firstly. Furthermore, if the received RA is notified as stored in the BL, the basic UCQoE VHO management framework then simply ignores this candidate wireless network and returns back to an idle status. Following this step, the basic UCQoE VHO management framework then instead checks the user preferences: If the user preference is found to be set to cost-free, the network-based VHO algorithm will be applied. Then using this setting, the network-based VHO algorithm proceeds to predict the time remaining in the current network. Here, if the user is indicated to be likely to remain in the coverage of the current network for more than the minimal remaining time (MRT), the network-based VHO algorithm ignores this network and switches the basic UCQoE VHO management framework to an idle status. On the other hand, if this is not the case, the network-based VHO algorithm instead targets this candidate wireless network and initiates vertical handover.

Nevertheless, some mobile users may have a mobile data allowance but also be concerned about the QoE of mobile video services, and could choose the quality-guarantee option in user preferences function in order to deliberately ensure an acceptable QoE of mobile video service. Furthermore, if the user preferences function is set to quality-guarantee, the QoE-driven VHO algorithm would be applied to maintain an acceptable QoE of mobile video services for mobile users. In this case, the type and connection time of the current connecting network is then checked. After this occurs, if the current connection time is detected to be less than the minimal connecting time (MCT), then the QoE-driven VHO algorithm simply ignores this candidate wireless network. On the other hand, the QoE-driven VHO algorithm

would continue to check the predicted MOS of the mobile video service. If the predicted MOS of mobile video service is revealed to be more than 3.5 (acceptable QoE), the QoE-driven VHO algorithm will then decide to remain in the current connected network. Otherwise, the QoE-driven VHO algorithm would instead initiate the handover and record the current network that is being connected in BL to avoid handover that is unnecessary.

Overall, by allowing mobile users to configure the user preference function on the basis of their actual requirements for QoE of mobile video services, the basic UCQoE VHO management framework is able to satisfy the mobile users' different requirements on QoE of mobile video services at different times. Additionally, the performance evaluation of the basic UCQoE VHO management framework will be presented in the next section.

5.3. Performance Evaluation of Basic UCQoE VHO Management Framework

This section will present the performance evaluation of the basic UCQoE VHO management framework. In this section, the simulation setup and scenarios will be introduced and the simulation results will be analysed to conclude the section.

5.3.1. Simulation Setup

In setting up the simulation, the basic UCQoE VHO management framework is implemented using the MIH standard in Network Simulator 2.29 (NS 2.29). Additionally, an Evalvid module is implemented in NS 2.29 to provide a video application with input video trace data. The simulations are designed to evaluate the performance of the basic UCQoE VHO management framework in a heterogeneous wireless network. Furthermore, the WiFi network and UMTS network are implemented as heterogeneous wireless networks and the WiFi network is located within the coverage of the UMTS network. At the beginning of the simulation, a mobile user with a mobile device is located from within the coverage of UMT

networks and outside the coverage of the WiFi network. Then, the mobile user then moves towards and stay in the coverage area of the WiFi network until the end of simulation. The network impairment (packet loss) will be set in the WiFi network to simulate a congested network environment. Furthermore, a video application will be run on the mobile device to receive video streaming from the video server. As the mobile device receives the video streaming, H.264 videos using different types of content will be used in simulations to check assess whether the basic UCQoE VHO management framework is able to satisfy mobile users across different types of content. Moreover, the mobile user shift between two different requirements in the simulations to check whether the proposed framework can maintain QoE of mobile video services according to the different requirements of the mobile user. Furthermore, the QoE performance of mobile video services will be monitored and generated in terms of MOS. In Fig. 5.3 below, the topology of the simulation is shown.

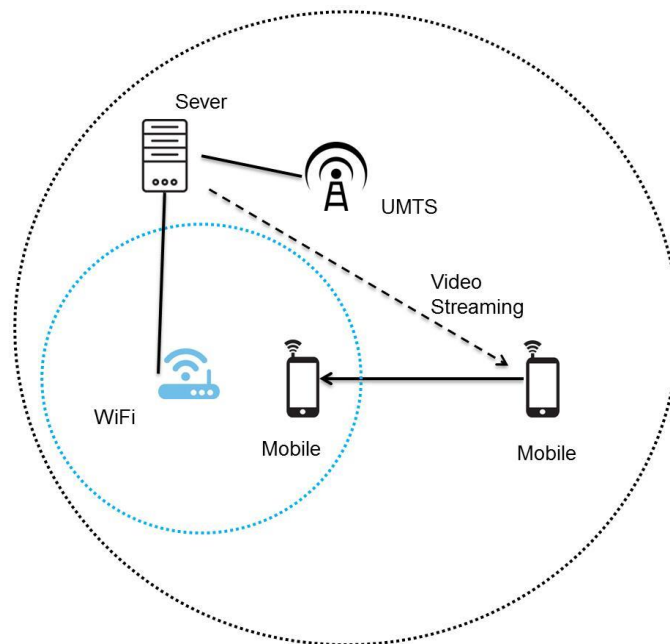

Figure 0.3: Simulation Topology

At the beginning of this simulation, the mobile device is connected to the UMTS network. The video application then begins receiving the video streaming from the video server over the UMTS network at the 20th second. After this is confirmed, the mobile then walks towards

the destination over the WiFi network coverage at 1 m/s. After the mobile user has arrived at the destination, he will stay within the coverage of the WiFi network. However, the WiFi network becomes congested at the 56th second: at this event, the packet loss will be applied to the WiFi network as network impairment and the packet loss rate will be set as being from 0% to 10% with fluctuating increments of 2%. Furthermore, the mobile user will be able to select the requirements of cost-free and quality-guarantee for the QoE of mobile video services in different simulations. In these simulations, to compare the performance of the QoE-dirven VHO algorithms applied to the proposed framework with the existing VHO algorithm, a QoS-based VHO algorithm is also implemented to maintain the QoE of mobile video services. Moreover, as indicated by the previous investigation in Chapter 3, an 8% packet loss rate is an appropriate criterion for a QoS-based VHO algorithm to make a handover decision [4]. The main simulation parameters are shown in Table 5.1.

Table 5.1: Simulation Parameters

Parameters	UMTS	WiFi	
Bandwidth	1 Mbps	11 Mbps	
Coverage	500 m	50 m	
Parameters	Mobile User		
Speed	1 m/s		
Parameters	SM Video	GW Video	RM Video
Video Frames	3000	3000	3060
Frame rate	25	25	25
Sending Bitrate	18 kbps	256 kbps	512 kbps

Overall, the basic UCQoE VHO management framework will be evaluated throughout these designed simulations. Throughout the following simulations, the following research questions will be investigated:

- Could the basic UCQoE VHO management framework satisfy mobile users with different requirements?

- Could the basic UCQoE VHO management framework provide better a QoE of mobile video services for users than the QoS-based VHO algorithm when the mobile user is concerned about the QoE in mobile video services?
- Could the performance of the basic UCQoE VHO management framework change according to the type of video content?

The simulations are divided into six groups based on the packet loss rate. Each group of simulations in turn tests three types of video and the two mobile user requirements for QoE in mobile video services. In the next section, the results of this simulation will be analysed and presented.

5.3.2. Results Analysis

In conducting this analysis, all results were divided into six sets based on different packet loss rates. Due to the large amount of results, a set of results with 4% and 6% packet loss rates will be displayed and analysed as examples. Furthermore, the overall MOS of the different VHO algorithms will also be presented.

4% Packet Loss

From Fig. 5.4 to 5.6, this reveals the QoE performance of the SM video, the GW video and the RM video over a WiFi network 4% packet loss in terms of MOS. In Fig. 5.4, this represents the average MOS of SM video over a WiFi network with a 4% packet loss rate. According to these results, when the packet loss rate was set to 4%, only the QoS-based VHO algorithm executed handover from WiFi to the UMTS network. Conversely, the other two VHO algorithms continued connecting to the WiFi network until the simulation ended. Furthermore, the QoS-based VHO algorithm achieved the best QoE of SM video in this simulation set. However, is the handover warranted in this situation? Here, even though the QoS-based VHO algorithm reached a high QoE, it still consumed more mobile data which

represents more cost for the end user. Furthermore, an acceptable QoE-driven VHO algorithm and network-based VHO algorithm did not provide as high a QoE of SM video when compared to the QoS-based VHO algorithm. However, the QoE of SM video provided by the QoE-driven VHO algorithm and network-based VHO algorithm were consistently acceptable, and the MOSs were more than 4 most of the time. Furthermore, the QoE-driven VHO algorithm and network-based VHO algorithm continued to connect to the WiFi network, which represented no additional cost for the user. Furthermore, as SM video is insensitive to packet loss, the difference in QoE between 4 and 4.5 is only small in the case of SM video; indicating that it is not worthwhile to incur additional cost for a similar QoE in SM video. In this case, the QoE-driven VHO algorithm made a better decision than the QoS-based VHO algorithm.

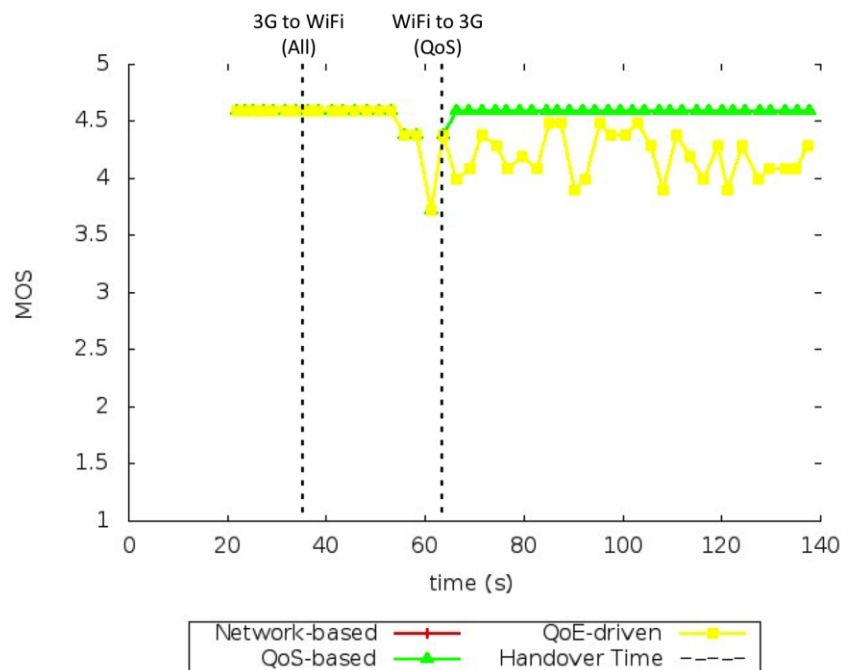

Figure 0.4: MOS of SM video over WiFi network with 4% packet loss

The average MOS of GW video with a 4% packet loss is represented in Fig. 5.5. In this simulation set, both the QoE-driven VHO algorithm and the QoS-based VHO algorithm executed handover from the WiFi network to the UMTS network. As the packet loss started to occur, all three VHO algorithms decided to remain connected to the WiFi network. During

this period, the QoEs of GW video were acceptable. Moreover, when the QoE-driven VHO algorithm detected an unacceptable QoE of GW video, it performed the handover from the WiFi network to the UMTS network immediately. However, the QoS-based VHO algorithm was not as quick at detecting that the QoE of GW video had deteriorated when compared to the QoE-driven VHO algorithm. Furthermore, the QoS-based VHO algorithm only noticed a poor QoE of GW video by the time the QoE had become even worse. By contrast, as the QoE-driven VHO algorithm was able to detect the unacceptable QoE of GW video earlier than the QoS-based VHO algorithm, it provided acceptable QoE of GW video earlier than QoS-based VHO algorithm. Additionally, even though the QoE-driven VHO algorithm did result in more cost than the QoS-based VHO algorithm, the most important outcome was that the QoE-driven VHO algorithm chose to fulfil the mobile users' requirement and avoided the worse amount of packet loss. On the other hand, the Network-based VHO algorithm persisted to connect to the WiFi network throughout the whole simulation as the mobile user's preference. In considering these results, the QoE-driven VHO algorithm achieved a better QoE of the GW video than with the QoS-based VHO algorithms, and prevented the QoE of the GW video from returning to an unacceptable quality level.

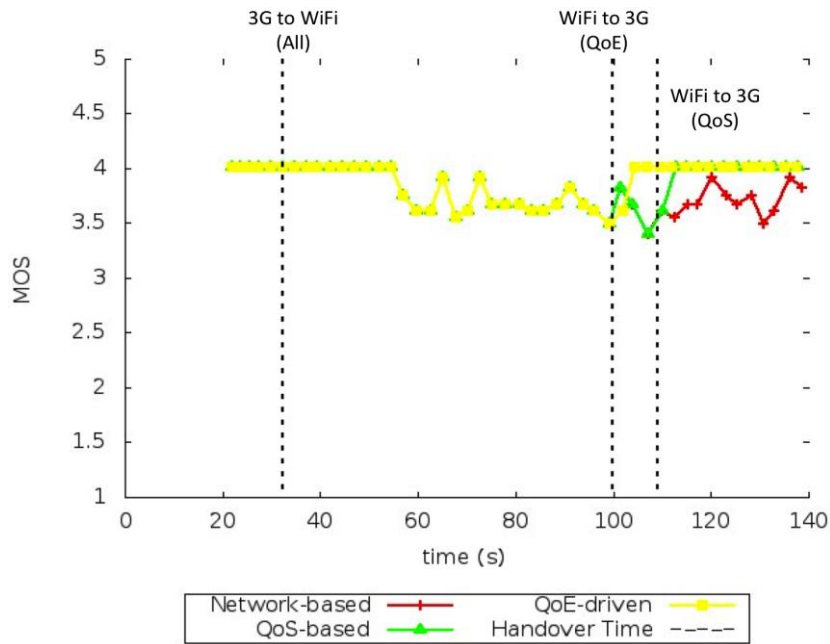

Figure 0.5: MOS of GW video over WiFi network with 4% packet loss

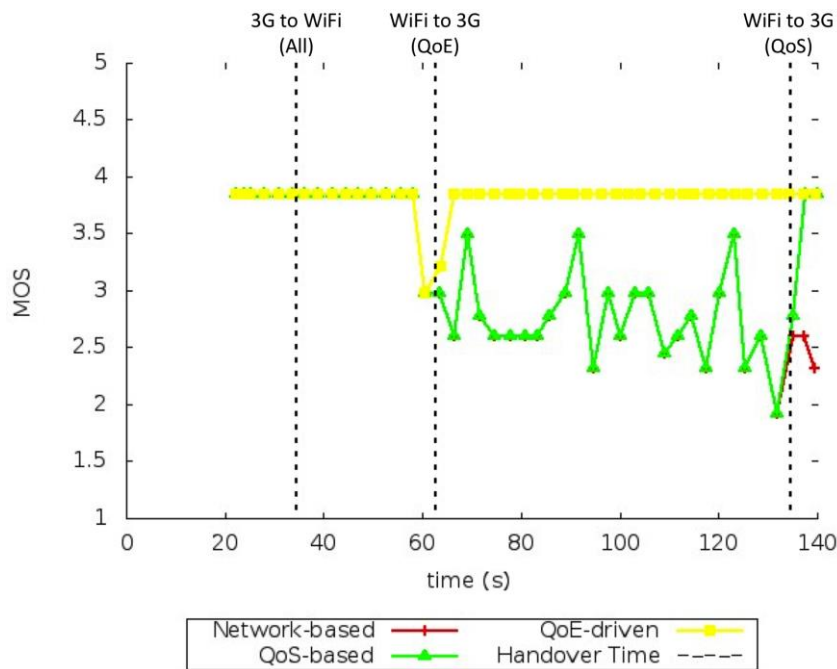

Figure 0.6: MOS of RM video over WiFi network with 4% packet loss

In Fig. 5.6 above, an average MOS of RM video with 4% packet loss rate is represented. Within this simulation set, the QoE-driven VHO algorithm quickly detected the dramatic deterioration in the QoE of RM video and executed handover from the WiFi network to the

mobile network accordingly at around the 62th second. Additionally, the QoE-driven VHO algorithm was able to effectively maintain an acceptable QoE of RM video for the mobile user. However, the QoS-based VHO algorithm failed to provide good QoE of RM video for the mobile user, as the QoS-based VHO algorithm did not detect that the QoE of the RM video had abruptly degraded in quality. In this simulation, the QoS-based VHO algorithm finally noticed significantly low QoE of RM video and made the handover decision at around the 135th second. Furthermore, as RM video is very sensitive to packet loss, the low packet loss rate would have a serious impact on the QoE of the RM video. Because of this, the QoS-based VHO algorithm was not able to detect the significant degradation in QoE of the RM video when the packet loss rate was lower than 8%. In addition to this result, it was also found that the performance of the QoE-driven VHO algorithm was much better than the QoS-based VHO algorithm. Moreover, the QoS-based VHO algorithm provided an unacceptable and significantly degraded QoE of RM video for mobile users for around 75 seconds. Also, the performance of the network-based VHO algorithm was significant poor, but this was understandable and acceptable to the mobile user: In this case, as the mobile user had selected the cost-free as their user preference, this meant that the users were not as much concerned about QoE of mobile video as they preferred to prioritise not incurring additional costs to their mobile data plan.

6% Packet Loss

In Figs. 5.7 to 5.9, this shows the QoE performance levels in mobile video services over a WiFi network with 6% packet loss.

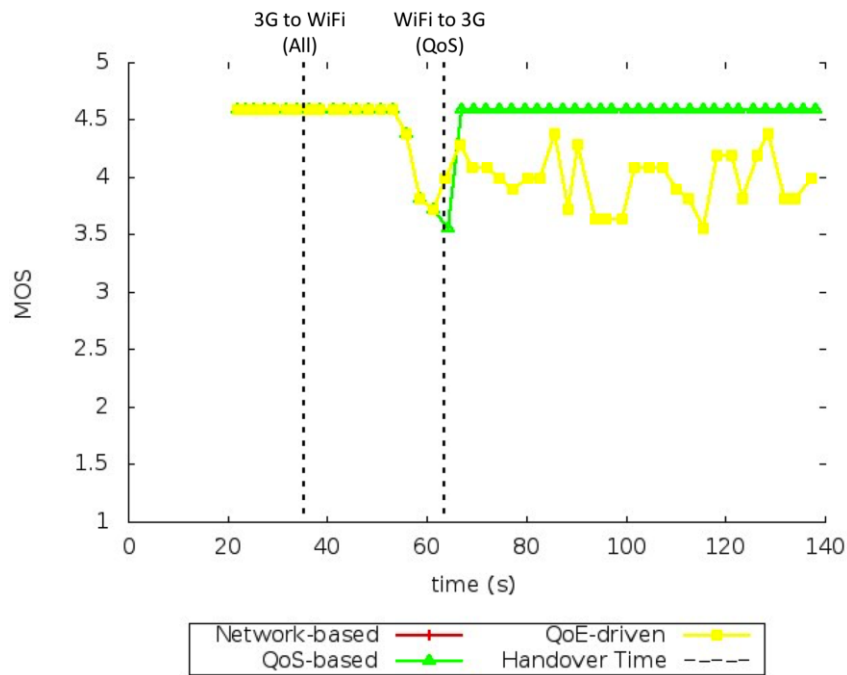

Figure 0.7: MOS of SM video over WiFi network with 6% packet loss

In Fig. 5.7, this represents the MOS of SM video over a WiFi network with 6% packet loss. In these simulations, only the QoS-based VHO algorithm made the handover decision of initiating handover from the WiFi network to the UMTS network. By contrast, both of the QoE-driven and network-based VHO algorithms did not initiate handover from the WiFi network to the UMTS network. Additionally, the QoE-driven VHO algorithm did not make the necessary handover decision to recover the QoE of SM video, as the QOE of the SM video was still acceptable to the mobile user. Furthermore, just as with the previous simulation set, as the mobile user indicated the preference of free network access, the network-based VHO algorithm was applied such that the connecting to an available WiFi network was prioritised.

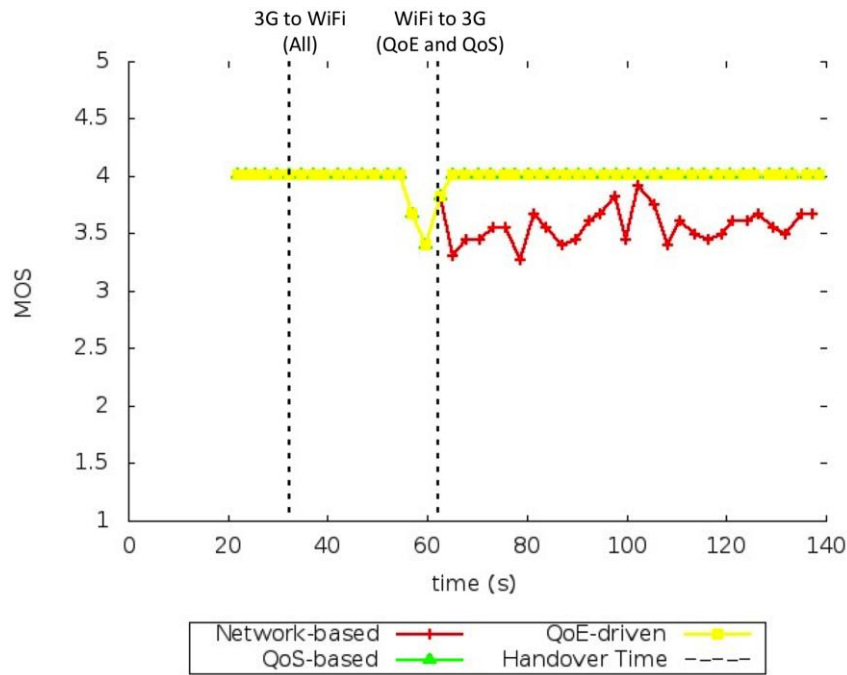

Figure 0.8: MOS of GW video over WiFi network with 6% packet loss

For this simulation set, the MOS of GW video over WiFi network with 6% packet loss is depicted in Fig. 5.8 above. In these simulations, the QoE-driven and QoS-based VHO algorithms initiated handover from the WiFi network to the UMTS network at same time to recover QoE of the GW video. Because of this, the QoE-driven and QoS-based VHO algorithms provides a similar QoE performance of the GW video. Furthermore, as the set preference of the mobile user was that of free network access, the network-based VHO algorithm was in turn applied to continue connecting to an available WiFi network even in instances where the QoE of the GW video became unacceptable.

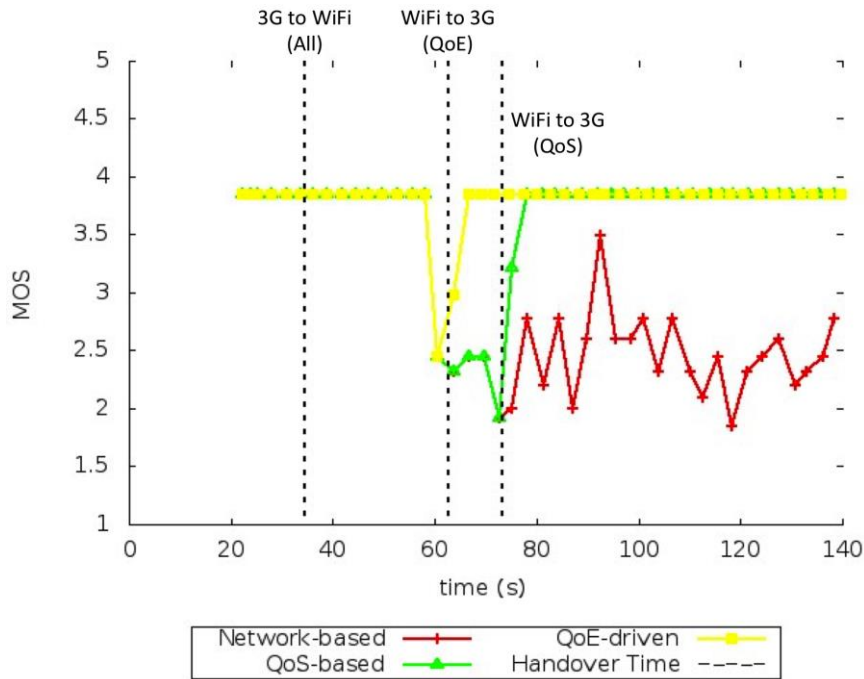

Figure 0.9: MOS of RM video over WiFi network with 6% packet loss

In this simulation set, Fig. 5.9 illustrates the QoE performance of RM video over a WiFi network with 6% packet loss. In these simulations, both the QoE-driven and QoS-based VHO algorithms initiated handover from the WiFi network to the UMTS network as a means to recover the QoE of the RM video. In this case, once the MOS of RM video was detected as less than 3.5, the QoE-driven VHO algorithm immediately initiated handover to recover the QoE of the RM video and maintain the QoE of the RM video at an acceptable level. Conversely, the QoS-based VHO algorithm did not detect the unacceptable QoE of the RM video as quickly as the QoE-driven VHO algorithm. However, as the QoE of RM video deteriorated even further ($MOS < 2$), the QoS-based VHO algorithm detected that the packet loss rate was higher than 8%, and then initiated VHO to recover the QoE of the RM video. Furthermore, in instances where the mobile user selected the preference of using a free network access service, the network-based VHO algorithm was applied such that the device continued to remain connected to the WiFi network.

Overall QoE Performance

In order to analyse and compare the overall performance of the three VHO algorithms, the overall MOSs of the three different videos under diverse packet loss rates are represented in Fig. 5.10, 5.11 and 5.12. Also, note that the overall MOS indicates the QoE from the beginning of the video application to the end.

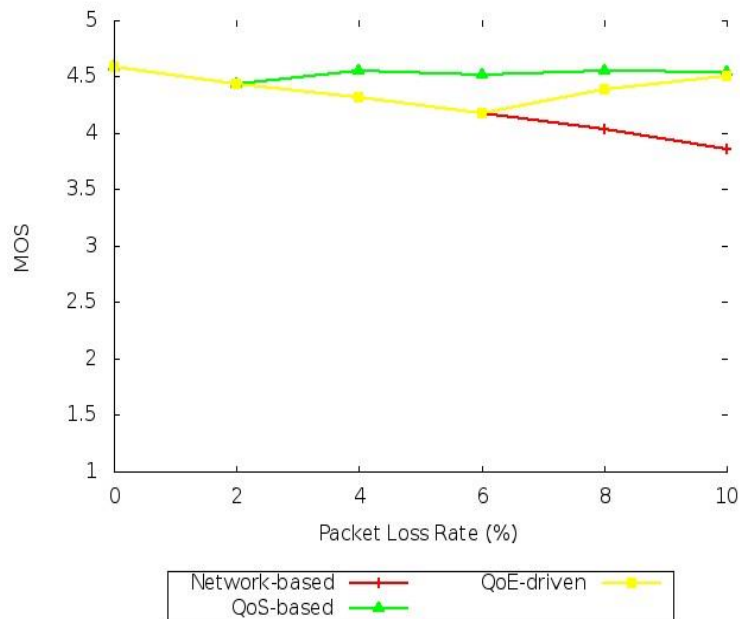

Figure 0.10: Overall MOS of SM video under different packet loss rate

In Fig. 5.10, the overall MOS of the SM video under diverse packet loss rate is represented above. In this simulation set, the QoS-based VHO algorithm always maintained the overall QoE of the SM video at an almost perfect level at around 4.5. Furthermore, when packet loss rate increased from 0% to 6%, the mobile video services was maintained by the QoE-driven VHO algorithm and network-based VHO algorithm resulted in the same QoE (more than 4) and decreased in response to increasing the packet loss rate. Nevertheless, when the packet loss rate became more than 6%, the QoE-driven VHO algorithm detected an unacceptable QoE of SM video and accordingly executed handover from the WiFi network to the UMTS network so as to maintain an acceptable QoE for mobile users. However, unlike the former, the network-based VHO algorithm continued to connect to the WiFi network and its QoE in

the SM video continued to fall as the packet loss rate increased further. For SM video, it appears that the QoS-based VHO algorithm resulted in a better QoE for mobile users than the QoE-driven VHO algorithm. However, there was no significant difference in the QoE of mobile video services between the QoE-driven VHO algorithm and the QoS-based VHO algorithm. Moreover, both VHO algorithms provided an acceptable QoE of mobile video services for mobile users. However, in spite of their similar results, the QoS-based VHO algorithm did incur more mobile data costs for the user, revealing an inefficiency of paying more for a marginally better or similar QoE in SM video.

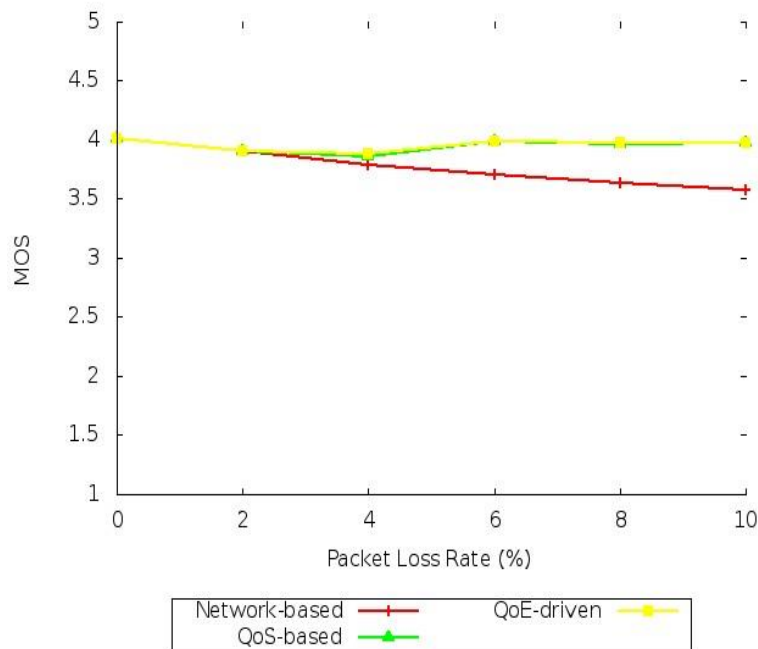

Figure 0.11: Overall MOS of GW video under different packet loss rate

In Fig. 5.11, the overall MOS of GW video under different packet loss rates is depicted. In the case of GW video, the performance of the QoE-driven VHO algorithm and QoS-based VHO algorithm were similar. In this simulation set, when the packet loss rate was set to 4%, both the user-centric QoE-driven VHO algorithm and the QoS-based VHO algorithm was able to detect the degradation of the QoE of mobile video services. Conversely, while the performance of the QoE-driven VHO algorithm was slightly better than the QoS-based VHO algorithm, this was only marginal: When packet loss rate was set to more than 4%, the

performance of the QoE-driven VHO algorithm and QoS-based VHO algorithm were almost the same. However, for the network-based VHO algorithm, the overall QoE of the GW video decreased with incremental increases in packet loss rate.

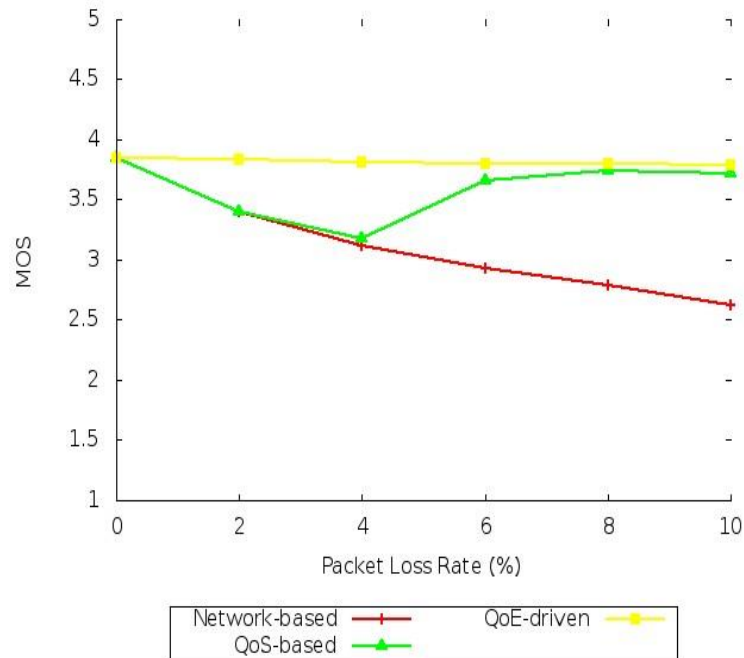

Figure 0.12: Overall MOS of RM video under different packet loss rate

In Fig. 5.12 above, this demonstrates the overall MOS of RM video under diverse packet loss rates. From this simulation set, it is obvious that the QoE-driven VHO algorithm successfully maintained the QoE of RM video for mobile users, irrespective of the packet loss rate. By contrast, for the QoS-based VHO algorithm, as the packet loss rate was set to 2% and 4%, the QoEs of the RM video fell to unacceptable levels. Additionally, once the packet loss rate exceeded 6%, the performance of the QoS-based VHO algorithm began to approach that of the QoE-driven VHO algorithm. However, as the QoS-based VHO algorithm only takes packet loss rate into consideration, it cannot detect significant degradation in the QoE of RM video. Furthermore, in terms of the network-based VHO algorithm, the QoE of RM video dramatically decreased as the packet loss rate increased. However, as the mobile users had selected the preference of a free network service rather than prioritising the QoE of the

mobile video service, the network-based VHO algorithm was still able to satisfy the mobile user even when the quality had degraded. Because of this, the QoE-driven VHO algorithm was able to maintain a better QoE of mobile video services than other two VHO algorithms. Moreover, while the RM video was easily affected by packet loss, the QoE-driven VHO algorithm still maintained an acceptable QoE of RM for mobile users under diverse rates of packet loss.

5.3.3. Summary

Firstly, the above results show that the basic UCQoE VHO management framework can be used to satisfy the mobile user with different requirements on the QoE of mobile video services at different times. Secondly, the basic UCQoE VHO management framework can be used to maintain the QoE of mobile video services regardless of the type of video content. Thirdly, these results also show that, when the mobile user selects the preference of prioritising the QoE of the mobile video service, the basic UCQoE VHO management framework is able to provide a better QoE of mobile video services than the QoS-based VHO algorithm. However, it may say that if the PER threshold of QoS-based VHO algorithm was defined corresponding to a MOS threshold of 3.5, QoS-based VHO algorithm also could maintain QoE of mobile video services as good as QoE-driven VHO algorithm. To be honest, it was possible in those simulations, but it was possible only in those simulations. Because the video application did not set to change video parameters in those simulations. According to the investigation in Chapter 3, video applications will adjust video parameters to recover degraded QoS and QoE of video services under different network conditions. While video parameters are changing in congested network, since QoE-driven VHO algorithm also considers video parameters, hence, it still can measure the QoE performance properly to make accurate handover decision. Conversely, QoS-based VHO algorithm cannot make

handover decision properly even though the PER thresholds are set corresponding as different types of video content.

In spite of this ability to customise the mobile experience according both consumption quality and selected user preferences, considering the acceptable QoE and cost alone is insufficient for satisfying all mobile users. Moreover, it is necessary that the requirements of mobile users are carefully classified. In this next section, this study will move on to introduce an advanced UCQoE VHO management framework.

5.4. Advanced UCQoE VHO Management Framework

Overall, the development of the advanced UCQoE VHO management framework builds on the basic UCQoE VHO management framework. Within the basic UCQoE VHO management framework, only two types of requirements for the QoE in mobile video services are defined, which is not enough to fulfil all requirements of the mobile user. For example, some mobile users have an unlimited mobile data allowance and as such do not mind constantly spending mobile data. Furthermore, mobile users prefer the prime QoE of mobile video services rather than QoE of mobile video services at acceptable level. In these cases, the basic UCQoE VHO management framework is unable to satisfy the mobile users. Thus, it is necessary to develop an advanced UCQoE VHO management framework to satisfy the mobile users who require excellent QoE of mobile video services consistently. The structure and performance evaluation of the advanced UCQoE VHO management framework will be presented in this section.

Furthermore, an advanced UCQoE VHO management framework is developed to satisfy mobile users with three different requirements on QoE mobile video services. The advanced UCQoE VHO management framework defines three types of requirements to represent all the requirements of the mobile user for the QoE of mobile video services. In an advanced

UCQoE VHO management framework, there are three options found in the user preferences: Prime QoE, Acceptable QoE and Cost-Free.

- **Prime QoE**

With this option, the prime QoE option is designed for the mobile users who have a high requirement of QoE in the mobile video service ($MOS > 3.8$). In instances where the mobile users set user their preference to prime QoE: when a WiFi network becomes congested that the QoE of the mobile video service would be unable to satisfy the mobile user, the mobile user in this case prefers to consume mobile data in order to maintain high QoE of the mobile video service without considering its cost. This group of mobile usually has an unlimited or large allowance of mobile data and therefore do not mind spending mobile data in order to maintain good QoE for the mobile video service in scenarios where the free WiFi service is congested. Nevertheless, some mobile users are solely interested in the content of video, and so prefer to use mobile data to maintain good QoE of the video as consistently as possible. This option could efficiently provide and maintain good QoE of mobile video services for mobile users, but it would probably incur more costs of mobile data than the other two options.

- **Acceptable QoE**

This user preference of acceptable QoE represents a standard that whereby the QoE of the mobile video service is acceptable to mobile users ($MOS > 3.5$). In instances where MOS becomes less than 3.5, mobile users under this preference type would deem the QoE of the mobile video service unacceptable. This option is suitable for mobile users who have a limited mobile data allowance but are concerned with the QoE of the mobile video service. Therefore, if a mobile user selects the 'acceptable QoE' option in user preferences, this indicates that the mobile user would have a lower requirement for the QoE of mobile video

service than Prime QoE, but that the QoE of the mobile video service must be maintained at an acceptable standard ($MOS > 3.5$). Additionally, in order to provide and maintain an acceptable QoE of mobile video services, the mobile users would also use mobile data in instances where a free WiFi network become congested. Furthermore, selecting the acceptable QoE option could provide and maintain an acceptable QoE of mobile video services for mobile users. As another factor, while the QoE of mobile video services under the acceptable QoE option may not be as high quality as that under the prime QoE option, the cost of mobile data under this acceptable QoE option would be less.

- **Cost-Free**

Unlike the above two options, the cost-free option is designed for mobile users who have no or very little of their mobile data allowance left and would like to avoid any costs of mobile data. Moreover, this group of mobile users is also not concern with the QoE of the mobile video services. Therefore, if the mobile users set their user preferences to cost-free, this indicates that the mobile user would prefer to only use free WiFi networks as they become available. Furthermore, no matter how poor the QoE of mobile video service is, this group of mobile users still prefers to use a free WiFi network. With this option selected, using mobile data could be avoided when a free WiFi network is available that the cost incurred from mobile data consumption could be kept at minimum.

Overall, depending on the three options selected in user preferences, three QoE-driven VHO algorithms are applied in the advanced UCQoE VHO management framework. Once the mobile user set the user preference, one of the three QoE-driven VHO algorithms will be select to manage VHO for satisfying the mobile users with appropriate QoE of mobile video services.

- **Prime QoE-driven VHO algorithm**

The Prime QoE VHO algorithm aims to provide and maintain prime QoE of mobile video services for mobile users. When using the prime QoE VHO algorithm, prime QoE of mobile video services is defined that the MOS should be over 3.8. When mobile users select prime QoE in user preferences, the prime QoE VHO algorithm will be applied to manage VHO. Additionally, the Prime QoE VHO algorithm will check QoE of mobile video services regularly based on the video parameters, the video type and the network conditions. Once the MOS is reduced to a level less than 3.8, the prime QoE VHO algorithm then initiates the VHO process to recover the prime QoE of the mobile video service. Due to these factors, the prime QoE VHO algorithm is therefore able to satisfy mobile users who have high requirement of QoE of mobile video services.

- **Acceptable QoE-driven VHO algorithm**

In this case, the acceptable QoE VHO algorithm is designed to provide and maintain the acceptable QoE of the mobile video services for mobile users who are concerned about the QoE of mobile video services but can also accept a reduction in QoE past the acceptable level ($MOS > 3.5$). Using this algorithm, if the mobile user sets the user preferences to the acceptable QoE option, the according acceptable QoE VHO algorithm will be selected to manage the VHO process. Additionally, so long as the QoE of the mobile video services fluctuates within an acceptable range, the acceptable QoE VHO algorithm would not make handover decision to initiate VHO. However, once the acceptable QoE VHO algorithm detects the MOS less than 3.5, it will begin to recover the QoE of the mobile video service by initiating the VHO process. Overall, the acceptable QoE VHO algorithm is able to satisfy mobile users who select the acceptable QoE option in their user preferences.

- **Network-based VHO algorithm**

Unlike the former algorithms, the network-based VHO algorithm grants different priority levels to different types of wireless networks. Using this method, mobile devices always

connect to the network with the highest priority. Among these wireless networks, the WiFi networks are given the highest priority. Because of this prioritisation, if the mobile user decides to select the cost-free option in the user preferences, the network-based VHO algorithm would be applied to make handover decision. Additionally, when the mobile user enters the coverage area of free WiFi network, the network-based VHO algorithm will decide to connect the WiFi network immediately. After this has occurred, no matter how poor the QoE of the mobile video service is, this network-based VHO algorithm will persist connecting the mobile device to the free WiFi network until the mobile user leaves the coverage area of the free WiFi network. Due to this prioritisation, the network-based algorithm is able to satisfy mobile users who would be like to avoid using mobile data in the coverage area of a free WiFi network.

Furthermore, the structure of the advanced UCQoE VHO management framework is represented below in Fig. 5.13. There are six main components in the advanced UCQoE VHO management framework: Video applications, the QoE prediction process, user preferences, the gathering of network information, the management of QoE-driven VHO algorithms and the MIH function.

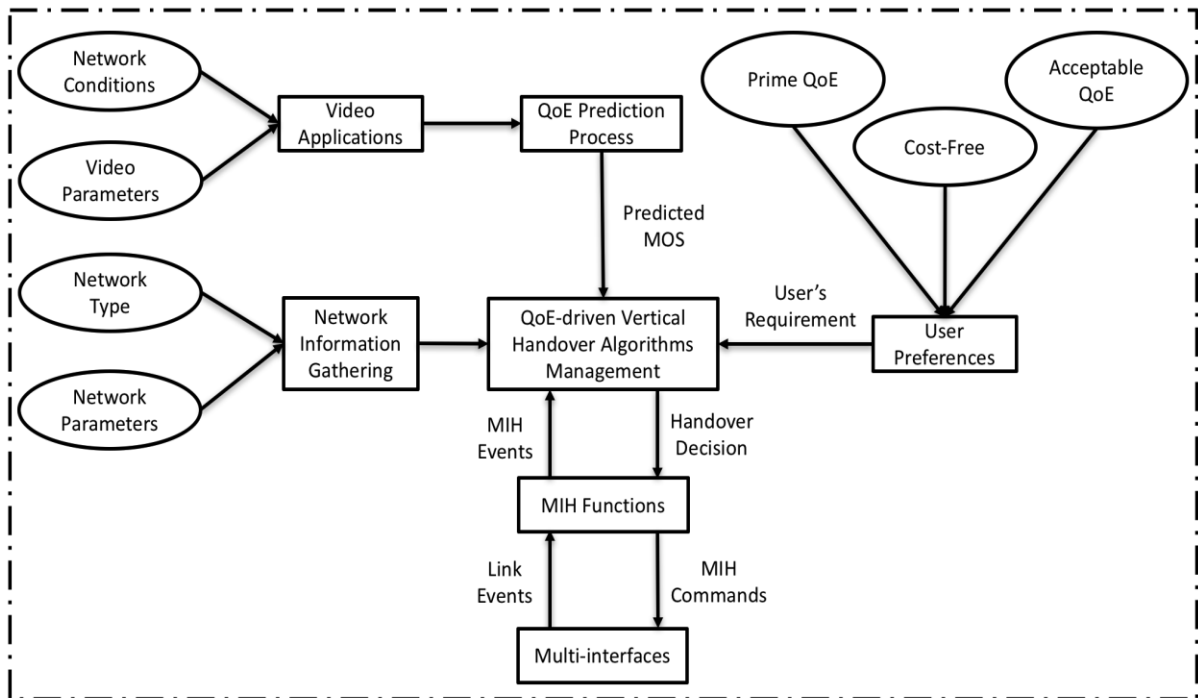

Figure 0.13: Structure of advanced UCQoE VHO management framework

In this case, the video application is designed to take responsibility for gathering the information of the network conditions and video parameters. After such information is gathered, the video application will send the collected information through the QoE prediction process to measure the QoE of the video services. Over the course of this process, the predicted QoE of video services will be used by QoE-driven VHO algorithms to make the vertical handover decision. The network information gathering process is designed to collect the information on the network type and the network parameters of available wireless networks. Furthermore, this collected network information is also important for the QoE-driven VHO algorithms to make the appropriate handover decision. The user preferences function used to acquire the user QoE-driven VHO algorithms constitutes the core of the advanced UCQoE VHO management framework. When a user preferences function is configured by the mobile user, an advanced UCQoE VHO management framework then selects an appropriate QoE-driven VHO algorithm from among the applied QoE-driven VHO algorithms to make the appropriate handover decision. Additionally, the MIH function also will monitor the MIH events that occur in the lower layers (the link layer and the physical

layer). All information of the MIH events is sent to the QoE-driven algorithms by the MIH function. In using this process, these QoE-driven VHO algorithms will make handover decision based on the information from the network information gathering process, the QoE prediction process and the MIH function. Lastly, once the handover decision is made, the MIH function will initiate the vertical handover process to switch the connection to the targeted network based on this decision.

As introduced above, the QoE-driven VHO algorithms management is at the core of the advanced UCQoE VHO management framework. The process flows of the QoE-driven VHO algorithm management are represented in Fig. 5.14 below.

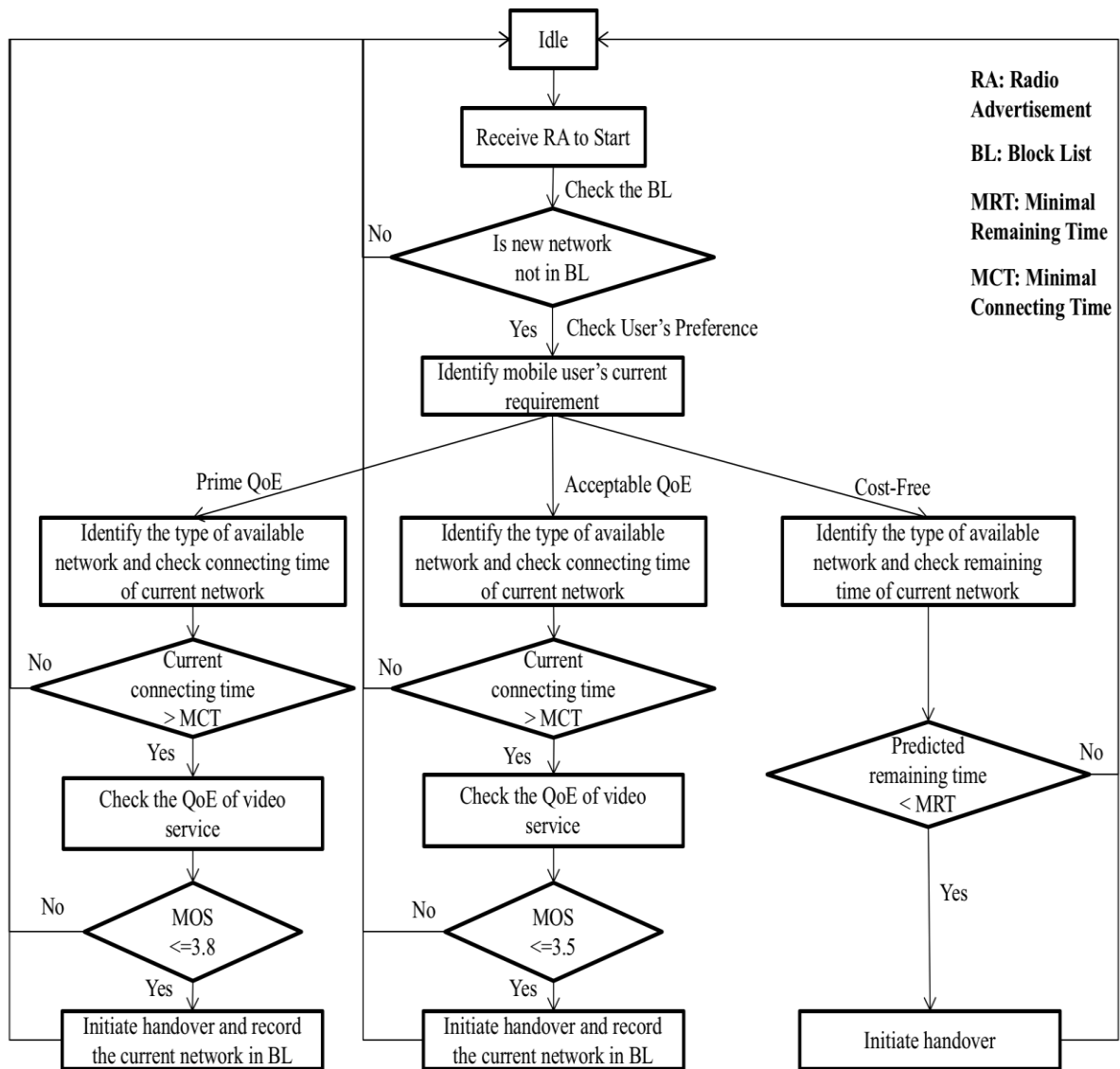

Figure 0.14: Process flow of QoE-driven VHO algorithms management

This process is only initiated once the RA from the available networks is received. If no RA is received, this is interpreted as meaning no other wireless network available apart from the UMTS network. In this case, to check the QoE of mobile video services will cause unnecessary waste of power and resources. Once a new RA has been received, the process of QoE-driven VHO algorithms management will be initiated. Firstly, the available network will be checked as to whether it has been stored in BL, which is stored information of the networks previously reported as unable to satisfy the mobile user. When this occurs, if the available network has been recorded in the BL, the available network will be abandoned and

the whole process will be terminated. Conversely, if the available network is not listed in the BL, the requirement of the mobile user will be assessed by checking the user preferences. After this step, depending on the requirements of the mobile user, the corresponding QoE-driven VHO algorithm will be chosen to make the handover decision. Following this, the processes for prime QoE and acceptable QoE are similar. Firstly, the type of available network and the connection time on the current network is checked: If the connection time on the current network is indicated to be less than MCT, the quality of the video service may not be recovered in this period. Due to this, the entire process will be terminated at this stage to avoid unnecessary handover. Conversely, when the current connection time is indicated to be longer than MCT, the current QoE of the mobile video service will be checked. Furthermore, in an advanced UCQoE VHO management framework, the prime QoE and acceptable QoE configurations are defined as MOS 3.8 and MOS 3.5. For example, when a mobile user sets the user preferences to prime QoE, if the current MOS of mobile video services is indicated to be higher than 3.8, the whole process will be terminated as the current QoE of mobile video service would not be able to satisfy the mobile user. Otherwise, when this occurs, the handover will be initiated and the current network will be recorded in BL, due to the current network being detected as unable to provide the QoE of the mobile video service as the requirement of the mobile user. When the user preference is set as cost-free, the time remaining on the current network will be measured. In instances where the remaining time is predicted to be longer than MRT, the entire handover process is aborted, as this indicates that the connection will remain stable during MRT. Conversely, if the predicted remaining time is less than MRT, the handover will be subsequently initiated. Overall, the advanced UCQOE VHO management framework can manage QoE-driven VHO algorithms to satisfy mobile users with three different requirements of mobile video services.

The advanced UCQoE VHO management framework aims to satisfy mobile users with three different requirements on QoE of mobile video services. The performance evaluation of advanced UCQoE VHO management framework will be presented in next section.

5.5. Performance Evaluation of Advanced UCQoE VHO Management Framework

In this section, the performance evaluation of advanced UCQoE VHO management framework will be depicted.

5.5.1. Simulation Setup

In recent years, as a means to attract new customers, free WiFi network services have been implemented in more and more public places, such as in Cafés, shopping malls and public buses.

In the majority of cases, customers are happy to use the free WiFi network when in a Café. However, due to the large number of customers, free public WiFi network services easily become congested. Furthermore, as different customers have different requirements on QoE of mobile video services, in the event that a free WiFi network does become congested, different actions need to be taken depending on the actual requirements of the mobile user. Hence, in this section, this common scenario will be simulated to evaluate the performance of the advanced UCQoE VHO management framework. In the simulation, the heterogeneous wireless networks consist of a UMTS network and a WiFi network. Furthermore, the WiFi network is located within the coverage of the UMTS network. Additionally, the scenario of the simulation is designed such that a mobile user is walking with a mobile device while also using mobile video services over the UMTS network at the beginning. Then, this mobile user will walk toward to a café at a speed of 1 m/s and this café provides a free public WiFi network for all customers. Further along in the simulation, once the mobile user arrives at the

Café, he will stay in at this location until the simulation is complete. To illustrate this, the topology of this simulation is demonstrated below in Fig. 5.15.

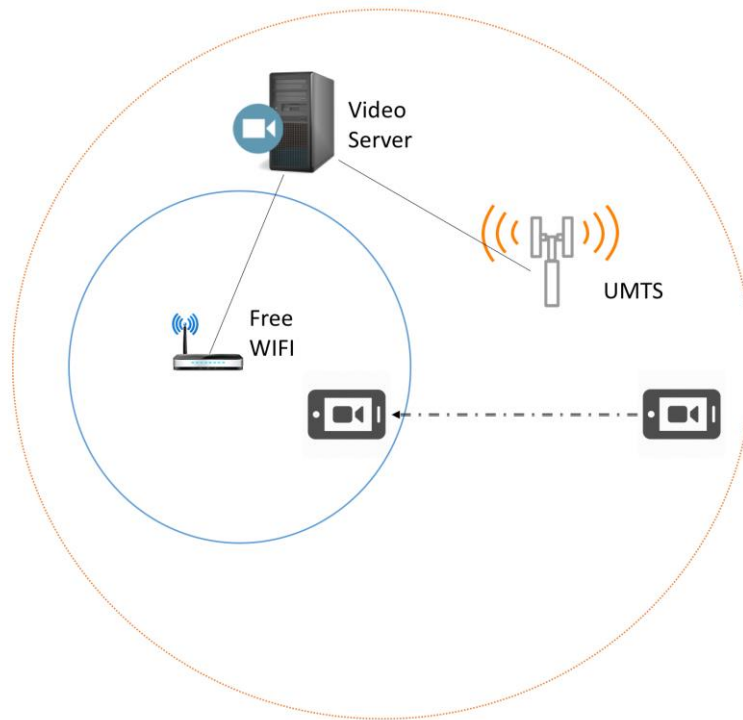

Figure 0.15: The topology of simulation

The NS2 is used to evaluate the advanced UCQoE VHO management framework with mobile video services over UMTS and WiFi networks. The EvalVid model was also implemented in NS2 to support video quality evaluation of H.264 videos. Furthermore, in order to assess whether the proposed framework would be able to maintain the QoE of mobile video services with different types of video content, three sample videos were applied through the video application to evaluate the performance of the proposed framework: these included the Akyio (SM video), Hall (GW video) and Football (RM video). In order to identify how the proposed framework handles the scenario of a congested network, network impairment (packet loss) also was applied in the WiFi network to simulate a congested wireless network environment. In simulating this, the packet loss rate was set from 0% to 10% with increments of 2%. Furthermore, three types of requirements on QoE of mobile video services were applied to represent the requirements of the mobile user: prime QoE,

acceptable QoE and cost-free. The parameters of the simulation are revealed below in Table 5.2.

Table 5.2: Parameters of mobile video service and wireless networks

Parameters	UMTS	WiFi	
Bandwidth	1 Mbps	11 Mbps	
Coverage Area	500m ²	50m ²	
Packet Loss Rate	0%	0% - 10%	
Parameters	SM Video	GW Video	RM Video
Frame Rate	25	25	25
Sending Bitrate	18 Kbps	256 Kbps	512 Kbps
Video Frames	3000	3000	3000

The simulations will be divided into six groups according to the packet loss rate. By conducting the simulations, the following research questions will be investigated.

- Could the advanced UCQoE VHO management framework provide the appropriate QoE of mobile video services as the actual requirements of mobile users?
- Could the advanced UCQoE VHO management framework satisfy mobile users with different requirements on mobile video services?
- Could the advanced UCQoE VHO management framework provide better QoE of mobile video services for users than the QoS-based VHO algorithm when mobile users concern about QoE of mobile video services?
- Could the performance of the advanced UCQoE VHO management framework maintain QoE of mobile video services regardless of the movement level in the video content?

The results of the simulations will be presented and analysed in following section.

5.5.2. Results Analysis

All results were divided into five sets based on the different packet loss rates. Due to the large amount of results, two sets of results with 4% and 6% packet loss rates will be presented and analysed in order to investigate the advanced UCQoE VHO management framework.

Furthermore, the overall QoE performance across the different types of video also will be presented, and the financial implications of the advanced UCQoE VHO management framework also will be explored.

4% Packet Loss

The respective performance levels in QoE of three videos delivered over a WiFi network with 4% packet loss are represented in Fig. 5.16 to 5.18.

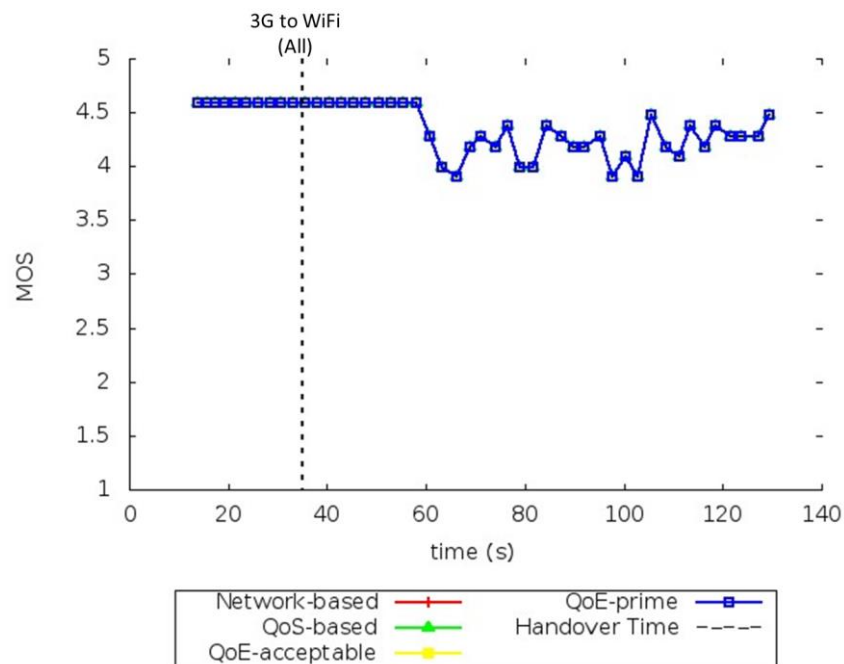

Figure 0.16: MOS of SM video over WiFi network with 4% packet loss

Fig. 5.16 shows the performance of QoE of mobile video services maintained by advanced UCQoE VHO management framework and QoS-based VHO algorithm over WiFi network with 4% packet loss. All VHO algorithms switched connection of the mobile video services to the WiFi network once the WiFi network became available. Then, when as the WiFi network became congested, all VHO algorithms did not initiate handover from the WiFi network to the UMTS network. For the prime QoE VHO algorithm and the acceptable QoE VHO algorithm, as the QoE of the SM video was still able to satisfy mobile user, hence both of them did not make handover decision. In accordance with the mobile user's requirements, the network-based VHO algorithm maintained the connection to the WiFi network, and even

when the WiFi network became congested. Additionally, the QoS-based VHO algorithm did not initiate handover from the WiFi network to the UMTS network, as the packet loss rate was lower than the threshold.

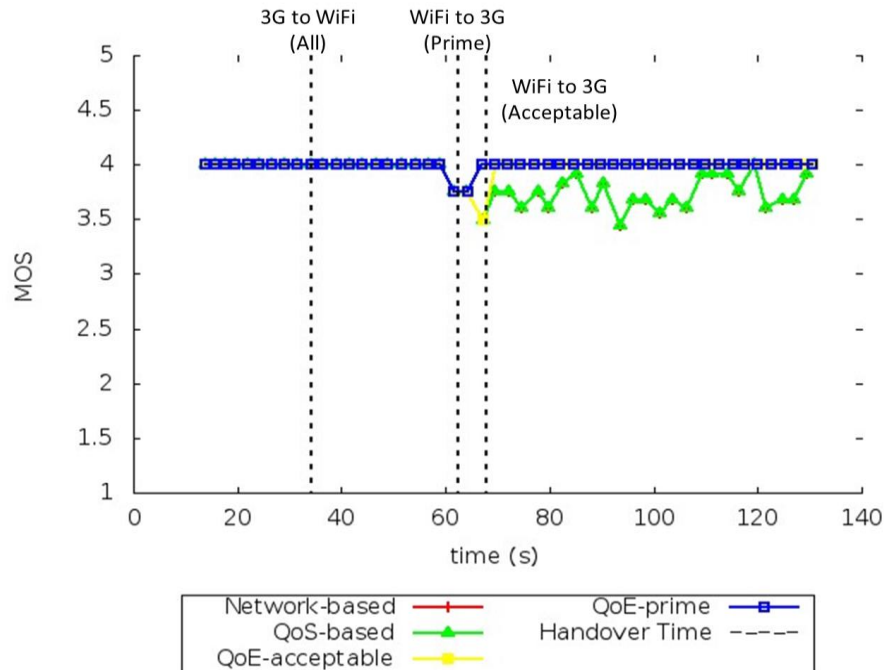

Figure 0.17: MOS of GW video over WiFi network with 4% packet loss

Fig. 5.17 demonstrates the QoE performance of GW video maintained by the advanced UCQoE VHO management framework and the QoS-based VHO algorithm over the WiFi network with 4% packet loss rate. The results showed that the prime QoE VHO algorithm executed vertical handover from the WiFi network to the UMTS network earlier than the acceptable QoE VHO algorithm. Once the MOS became less than 3.8, the handover was immediately initiated by the prime QoE VHO algorithm to maintain excellent QoE of GW video services which was the mobile user's prime QoE requirement. Then, until QoE of mobile video services degraded to an unacceptable level (MOS <3.5), the acceptable QoE VHO algorithm initiated vertical handover from the WiFi network to the UMTS network to recover the QoE of the GW video services. Nevertheless, since the packet loss rate still was less than the threshold of handover decision of QoS-based VHO algorithm, the QoS-based VHO algorithm did not make handover decision to recover the QoE of GW video, even as the

QoE of GW video degraded to an unacceptable to the mobile user. Hence, the QoS-based VHO algorithm is unable to maintain acceptable QoE of GW video for mobile users over a free WiFi network with 4% packet loss. Furthermore, even though the network-based VHO algorithm did not initiate handover from the WiFi network to the 3G network as the WiFi network became congested, since the mobile user’s requirement on the mobile video service was cost-free, the QoE performance of GW video still was able to satisfy the original preference of the mobile user. Moreover, the mobile user also expected that the QoE of GW video may become unacceptable with the free WiFi network.

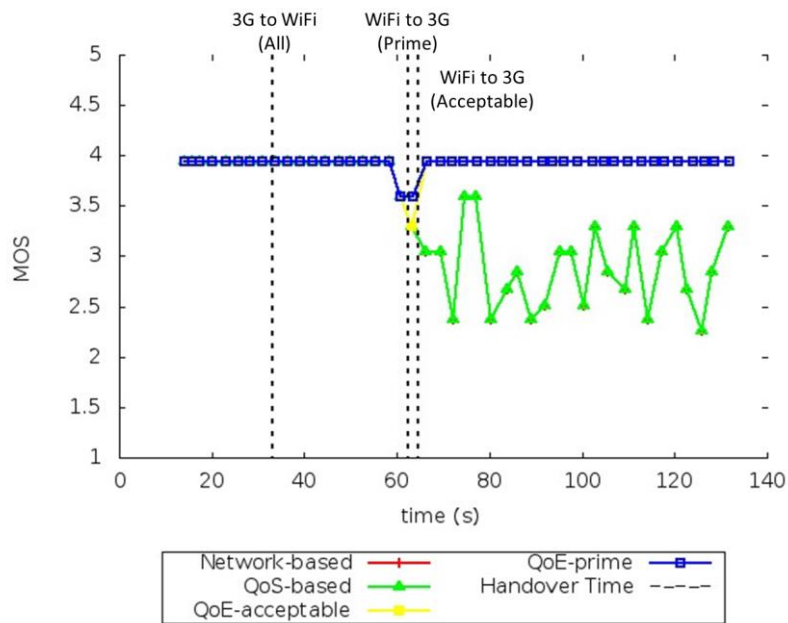

Figure 0.18: MOS of RM video over WiFi network with 4% packet loss

The QoE performance of the RM video with 4% packet loss are represented in Fig. 5.18. As similar to GW video, when the mobile user had requirements for the QoE of the video service, both the prime QoE VHO algorithm and the acceptable QoE VHO algorithm initiated handover in time to avoid significant degradation of the QoE of the RM video. Furthermore, when the mobile requested to use free WiFi network and set their user preference as cost-free, the advanced UCQoE VHO management framework applied the network-based VHO algorithm to satisfy the mobile user’s requirements by keeping continuing to connect to the

WiFi network. Furthermore, the mobile user also had the expectation of unacceptable QoE of the video service when delivered over the free WiFi network when they had set their user preference to cost-free. However, no matter what the mobile user requirements for the QoE of RM video were, the QoS-based VHO algorithm still did not initiate handover, and even at the point the QoE of RM video had reached an unacceptably degraded quality. Hence, when the packet loss rate was 4%, the QoS-based VHO was not able to maintain the QoE of RM video for the mobile user who required acceptable or prime QoE of video service.

6% Packet Loss

The QoE performance of the three videos over WiFi network with 6% packet loss are demonstrated below in Fig. 5.19 to 5.21.

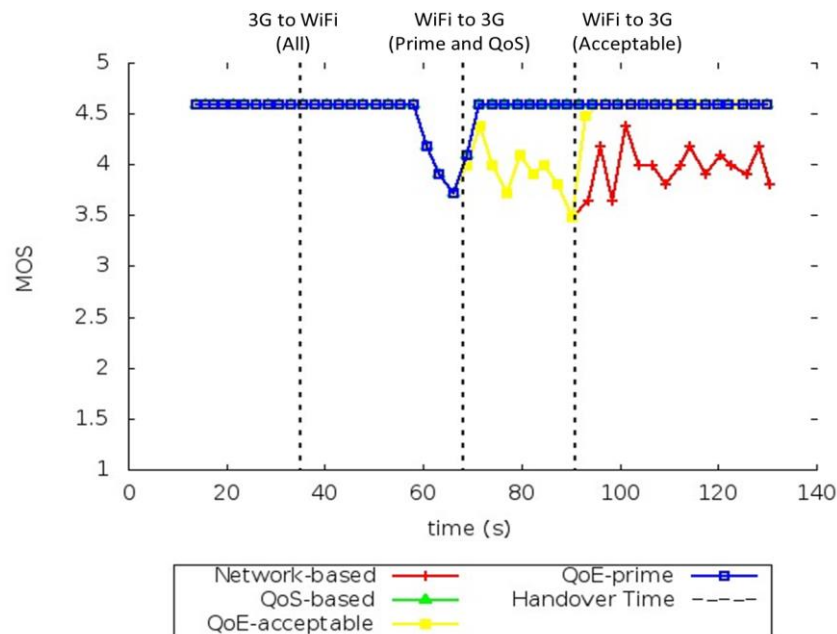

Figure 0.19: MOS of SM video over WiFi network with 6% packet loss

Fig. 5.19 shows the QoE performance of SM video over a WiFi network with 6% packet loss. The Prime QoS VHO algorithm and the QoS-based VHO algorithm initiated handover from the WiFi network to the UMTS network in order to recover the degradation of the QoE of SM video at the same time. Thus, when the mobile user required prime QoE of SM video,

both of prime QoE VHO algorithm and QoS-based VHO algorithm could make handover decision in time to maintain prime QoE of SM video over WiFi network with 6% packet loss. Acceptable QoE VHO algorithm also initiated handover from WiFi network and UMTS network, but it made the handover decision later than both of prime QoE VHO algorithm and QoS-based VHO algorithm. However, when the mobile user required acceptable QoE of SM video, acceptable QoE VHO algorithm could generate less cost of mobile data than QoS-based VHO algorithm. When the mobile user preferred free WiFi network, network-based VHO algorithm did not make handover decision and kept connecting to free WiFi network.

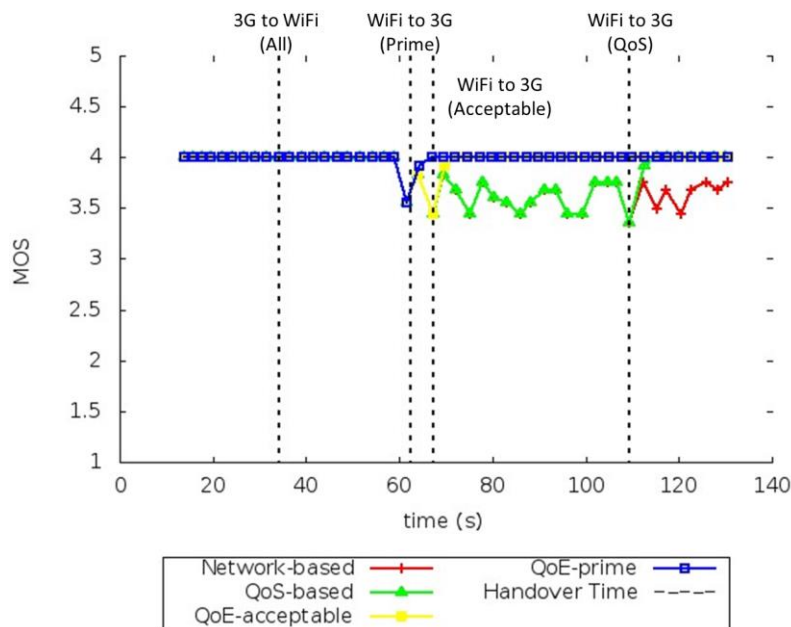

Figure 0.20: MOS of GW video over WiFi network with 6% packet loss

Fig. 5.20 shows the QoE performances of GW video over WiFi network with 6% packet loss. In this set of simulations, prime QoE VHO algorithm was the earliest VHO algorithm to initiate the handover from WiFi network to UMTS network. Acceptable QoE VHO algorithm made handover decision just few seconds later than prime QoE VHO algorithm. Both of prime QoE VHO algorithm and acceptable QoE VHO algorithm maintained QoE of GW video as mobile user's the actual requirements at different time. If the mobile user would like to use avoid cost of mobile data while free WiFi network was available, UCQoE VHO

management framework applied network-based VHO algorithm to keep connecting to free WiFi network. QoS-based VHO algorithm made handover decision around 108th second. However, when the mobile user had demands on QoE of GW video, QoS-based VHO algorithm could not satisfy the mobile user over WiFi network with 6% packet loss in time. Moreover, QoS-based VHO algorithm also could not satisfy the mobile user, when the mobile user preferred free WiFi network.

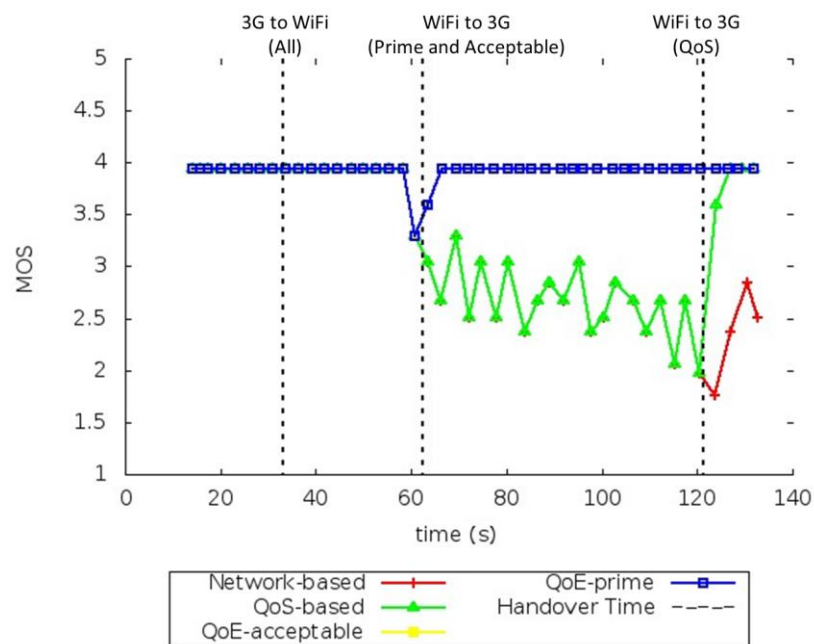

Figure 0.21: MOS of RM video over WiFi network with 6% packet loss

QoE performances of RM video over WiFi network with 6% packet loss are showed in Fig. 5.21. In this set of simulations, prime QoE VHO algorithm and acceptable QoE VHO algorithm initiated handover from WiFi network to UMTS network at same time. Both of prime QoE VHO algorithm and acceptable QoE VHO algorithm successfully maintained QoE of RM video over WiFi network with 6% packet loss in time. When the mobile user would like to user free WiFi network, network-based VHO algorithm was applied to keep connecting to WiFi network regardless of congestion. However, QoS-based VHO algorithm could not recover QoE of RM video in time, when the mobile user required prime or

acceptable QoE of RM video. Furthermore, QoS-based VHO algorithm also could not satisfy the mobile user, when the mobile user preferred free WiFi network.

Overall QoE Performances

The overall QoE performances of the three types of videos are displayed in Fig. 5.22 to 5.23. To increase the accuracy of difference of performances between different VHO algorithms, the overall MOS were counted starting from the time of handover from 3G network to WiFi.

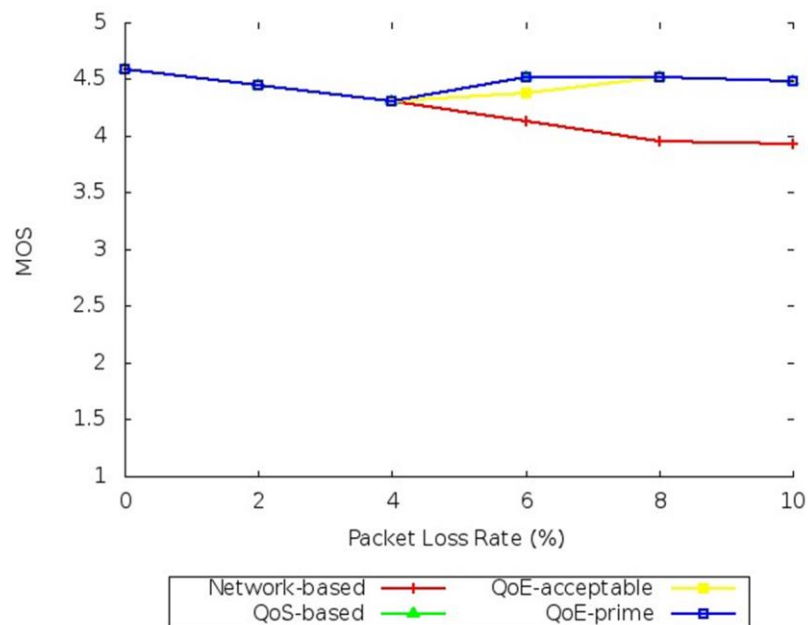

Figure 0.22: Overall MOS of SM video over WiFi network

Fig. 5.22 shows the overall MOS of SM video under diverse packet loss rates. When the mobile user required prime QoE of SM video, prime QoE VHO algorithm and QoS-based VHO algorithm maintain similar QoE performance of SM video under diverse packet loss rates. When the mobile user only required acceptable QoE of SM video, acceptable QoE VHO algorithm also maintained similar QoE performance of SM video as both of prime QoE VHO algorithm and QoS-based VHO algorithm under diverse packet loss rates except 6% packet loss. When the packet loss rate was set to 6%, prime QoE VHO algorithm and QoS-based VHO algorithm maintained better overall QoE performance of SM video than acceptable QoE VHO algorithm. When the mobile user would like to use free WiFi network,

network-based VHO algorithm was applied to keep connecting free WiFi network. Hence, all VHO algorithms did make handover decision and provided same QoE performance of SM video while packet loss rates were set from 0% to 4%. Once the packet loss rate was larger than 4%, only network-based VHO algorithm still did not make handover decision to avoid congestion. Nevertheless, the other three VHO algorithm all initiated handover to recover the QoE of SM video.

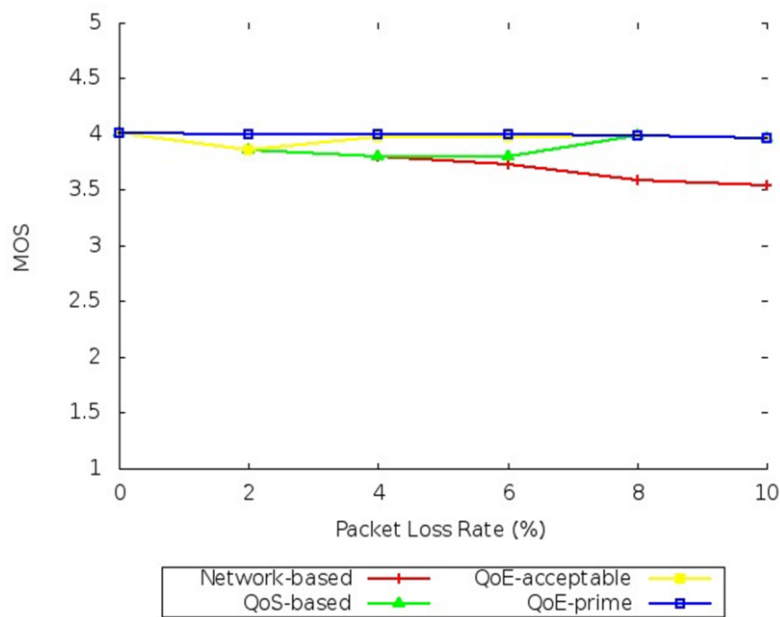

Figure 0.23: Overall MOS of GW video over WiFi network

Overall QoE performances of GW video under diverse packet loss rates are showed in Fig. 5.23. Among all VHO algorithms, prime QoE VHO algorithm provided best QoE performance of GW video under different packet loss rates. When packet loss rates became larger than 2%, acceptable QoE started to initiate handover to recover QoE performance of GW video. However, until packet loss rate increased to 6%, QoS-based VHO algorithm began to make handover decision to recover QoE performance of GW video. As the cost-free requirements of mobile user, network-based VHO algorithm did not initiate handover in all simulations. Thus, if the mobile user had demands on QoE of GW video, the advanced UCQoE VHO management framework applied acceptable and prime QoE VHO algorithms

to maintain better QoE performance of GW video than QoS-based VHO algorithm. When the mobile user would like to use free WiFi network regardless of QoE of GW video, QoS-based VHO algorithm also could not satisfy the mobile user.

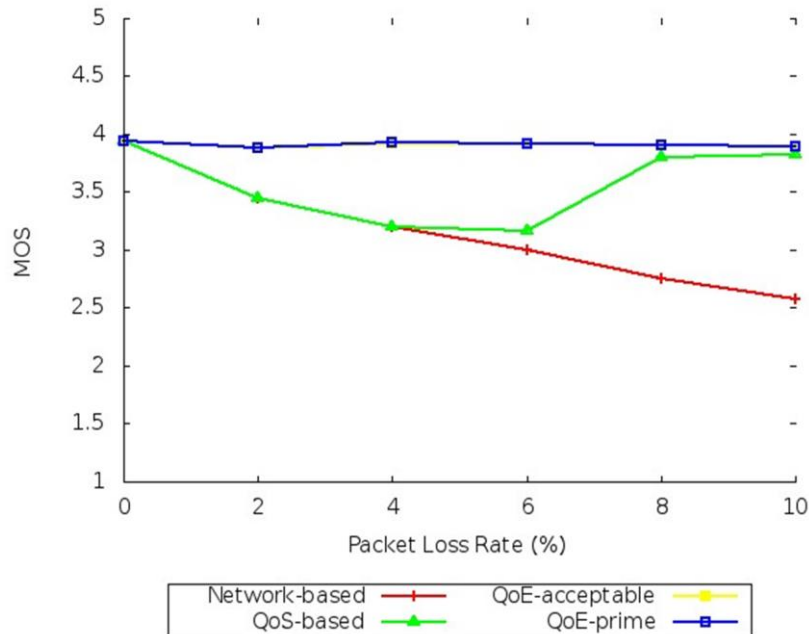

Figure 0.24: Overall MOS of RM video over WiFi network

Fig. 5.24 shows the overall QoE performances of RM video under diverse packet loss rates. Since RM video was very sensible to packet loss, 2% packet loss led to both prime QoE VHO algorithm and acceptable QoE VHO algorithm making a handover to recover QoE of RM video. Hence, prime QoE VHO algorithm and acceptable QoE VHO algorithm provided similar QoE performances of RM video under diverse packet loss rates. As the mobile user's cost-free requirement, network-based VHO algorithm was applied to keep connecting to free WiFi network while free WiFi network was available. However, QoS-based VHO algorithm only began to initiate handover for QoE recovering while packet loss rate increased to 6%. Furthermore, no matter what requirements the mobile user had, QoS-based VHO algorithm could not recover QoE of RM video in time to satisfy the mobile user. Even if mobile user preferred to use free WiFi network, QoS-based VHO algorithm also could not satisfy the mobile user.

5.5.3. Summary

This section introduced an advanced UCQoE VHO management framework. Several groups of simulations were carried out to evaluate the performance of the advanced UCQoE VHO management framework with three mobile users' requirements. Depending on the analysis of results, the following conclusions have been summarised: 1) The advanced UCQoE VHO management framework can applied different VHO algorithms to satisfy mobile user with different requirements at different time. 2) The VHO algorithms applied in the advanced UCQoE VHO management framework can provide better QoE of video services than QoS-based VHO algorithm with different mobile user's requirements. 3) The advanced UCQoE VHO management framework can maintain QoE of different types of videos to satisfy mobile user's different requirements.

5.6. Financial Impacts

The financial impacts of advanced UCQoE VHO management framework and QoS-based VHO algorithm will be discussed as following. To investigate the relationship between QoE performance and cost of mobile data, the connection times of mobile network and WiFi network has been calculated and convert to proportions of total network connection time. The total network connection time counted from the time of handover from mobile network to WiFi network and ending at the end of video application. The overall QoE performances and proportions of mobile network connection time are showed in Fig. 5.25 to 5.27. In those figures, bars represented the proportions of mobile network connection time and lines denoted as overall QoE performance of mobile video services. More mobile network connection time means more cost of mobile data.

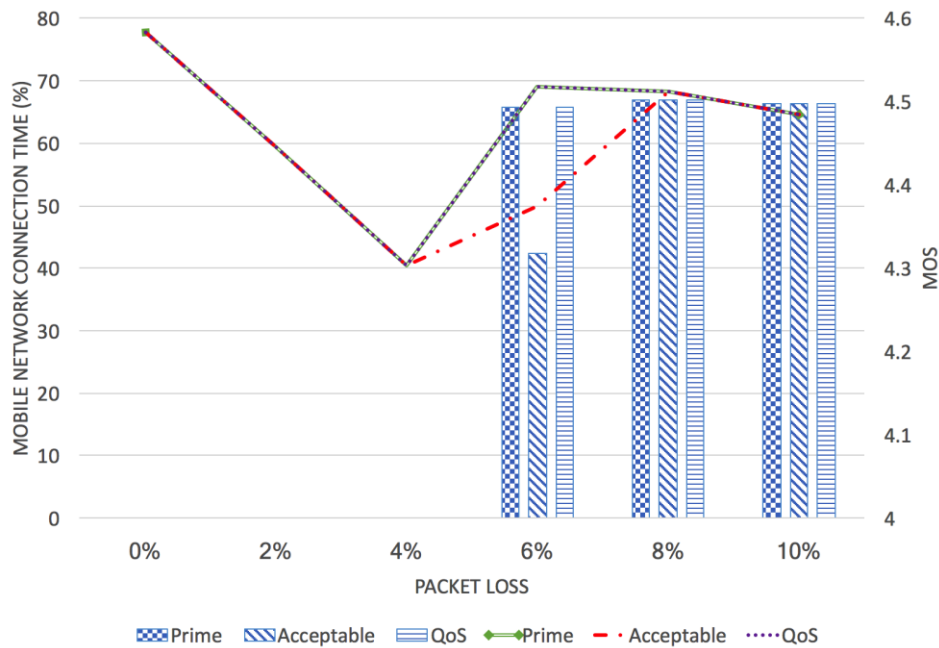

Figure 0.25: Overall QoE performance and mobile proportions of mobile network connection time of SM video under diverse packet loss rates

Fig. 5.25 shows the overall QoE performance and mobile network and proportion of mobile network connection time of SM video. All three VHO algorithms did not generated any mobile data until packet loss rate increased to 6%. Furthermore, when packet loss rate was set to 6%, all three VHO algorithms initiated handover to recover the QoE of SM video. Prime QoE acceptable VHO algorithm and QoS-based VHO algorithm maintained better QoE of SM video than acceptable QoE VHO algorithm. However, acceptable QoE VHO algorithm generated less mobile data than prime QoE VHO algorithm and QoS-based VHO algorithm. When packet loss rate was more than 6%, all three VHO algorithms provided similar QoE of SM video and generated similar amount of mobile data.

Overall QoE performance and proportion of mobile network connection time are displayed in Fig. 5.26. When packet loss rate was 2%, only prime QoE VHO algorithm began to make handover decision to recover the QoE of GW video and generated cost of mobile data. Acceptable QoE VHO algorithm started to initiate handover form WiFi network to UMTS network to recover QoE of GW video, when packet loss rate was 4%, but it generated less mobile data than prime QoE VHO algorithm. QoS-based VHO algorithm started to initiate

handover to recover QoE of GW video while packet loss rate was 6%. Even though QoS-based VHO algorithm generated least mobile data, but it provided worst QoE of GW video among three VHO algorithms. Moreover, prime QoE VHO algorithm still cost the most mobile data. When packet loss rate became larger than 6%, all three VHO algorithms provided similar QoE of GW video and generated similar cost of mobile data.

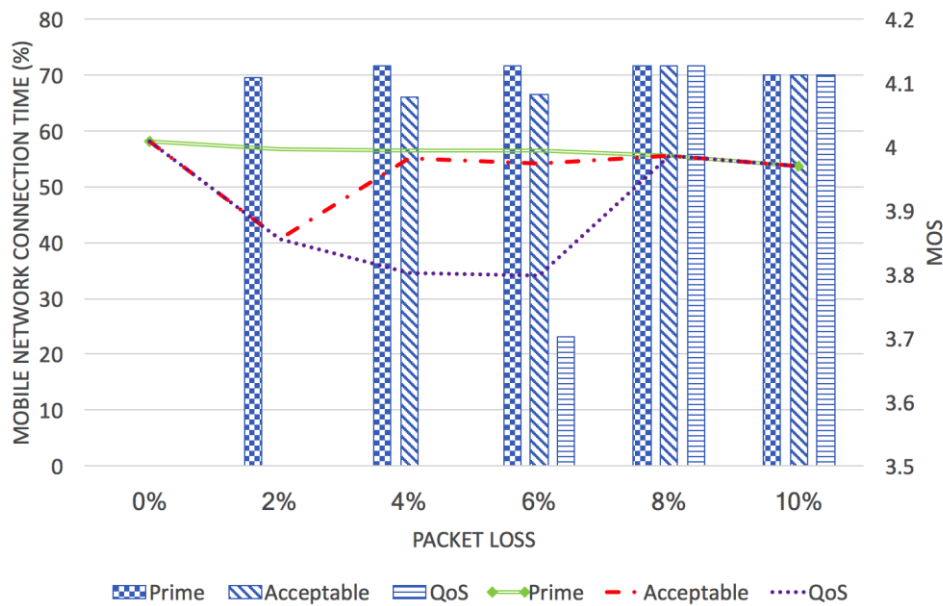

Figure 0.26: Overall QoE performance and proportions of mobile network connection time of GW video under diverse packet loss rates

Fig. 5.27 shows the overall QoE performance and proportions of mobile network connection time of RM video. In this groups of simulations, both of prime QoE VHO algorithm and acceptable QoE VHO algorithm began to initiate handover to recover QoE of RM video while packet loss rate was 2%. Furthermore, prime QoE VHO algorithm and acceptable QoE VHO algorithm provided similar QoE performance of RM video and spent almost same amount of mobile data. Acceptable QoE VHO algorithm only maintained slightly worse QoE performance of RM video than prime QoE VHO algorithm, when packet loss rate was 4%. The QoE performance of RM video maintained by QoS-based VHO algorithm significantly degraded with the increment of packet loss rate. Moreover, QoS-based VHO algorithm only started to initiate handover to recover QoE of RM video until packet loss rate increased to 6%.

Even though QoS-based VHO algorithm generated less cost of mobile data than prime QoE VHO algorithm and acceptable QoE VHO algorithm. However, prime QoE VHO algorithm and acceptable QoE VHO algorithm provided better QoE performance of RM video than QoS-based VHO algorithm.

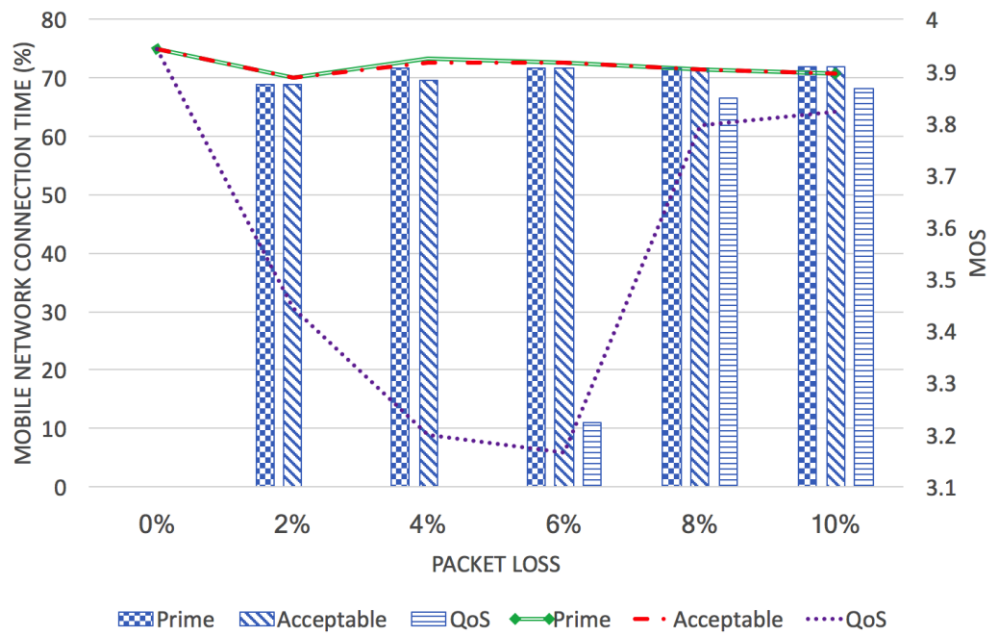

Figure 0.27: Overall QoE performance and proportions of mobile network connection time of RM video under diverse packet loss rates

5.7. Summary

This chapter proposed a basic UCQoE VHO management framework and an advanced UCQoE VHO management framework to maintain QoE of mobile video services based on mobile users' requirements. A user preferences function is designed to acquire mobile user's actual requirements on mobile video services in UCQoE VHO management framework. Moreover, a reference-free QoE prediction model is implemented in UCQoE VHO framework to measure QoE of video services for VHO algorithm to make handover decision. The basic UCQoE VHO management framework can satisfy mobile users with two basic requirements on mobile video services. The advanced UCQoE VHO management framework

is developed based on the basic UCQoE VHO management framework that it defines three different type of requirements for mobile users to cover most of mobile users' requirements. The results of simulations showed that the advanced UCQoE VHO management framework can satisfy mobile user's different requirements on mobile video services regardless of types of videos at different times. Moreover, the simulations also were run based on different random seed that the results still proved that the advanced UCQoE VHO management framework could provide and manage appropriate QoE of mobile video services and cost as mobile users' requests.

Chapter 6: Conclusions and Future Work

6.1. Introduction

In recent years, with the development of wireless technologies, users increasingly use mobile video services over heterogeneous wireless network and mobile video services dominate the network resources in a heterogeneous wireless network. Furthermore, as mobile users are concerned with QoE more than ever before, it is important to provide and maintain the QoE of mobile video services for mobile users according to their actual requirements/preferences.

Since not any single wireless access technology alone is able to satisfy the requirements of the mobile user on QoE of mobile video services anywhere and at any time, it is necessary to combine the advantages of different wireless access technologies in heterogeneous wireless networks. To achieve this goal, vertical handover (VHO) is a reasonable solution. Furthermore, the MIH standard is designed to provide seamless VHO for allowing mobile devices to switch network connections between different wireless access technologies without interrupting network connections. However, as the MIH standard only provides a default bandwidth-based VHO algorithm for selecting the candidate wireless network in heterogeneous wireless networks, the QoE of mobile video services is not able to be effectively maintained or recovered in time. Furthermore, the method of selecting a candidate wireless network to target, and the timing of initiating handover could significantly affect the QoE of mobile video services. Hence, the key to satisfy the requirements of the mobile user on QoE of mobile video services is to select the appropriate candidate wireless network and initiate handover at the appropriate time based on an appropriate set of criteria incorporated into the VHO algorithm. Additionally, the actual requirements of the mobile users for QoE of mobile video services could also be considered in the VHO algorithm to effectively satisfy mobile users under different situations. The work presented in this thesis aims to provide and

maintain the QoE of mobile video services as mobile users' different requirements on QoE of mobile video services at different times.

6.2. Contributions to Knowledge

The main contributions presented in this thesis are:

- 1) An investigation of the detailed understanding of the relationships between the QoS and QoE of mobile video services, video content and network impairments (e.g. packet loss rates and available bandwidth).**

This work has contributed to a detailed understanding of the perceptual effects of key network parameters and video parameters in the QoE of mobile video services. A fundamental investigation to study how network impairments (i.e. the packet loss rate and available bandwidth) and video content impacting the QoS and QoE of mobile video services are carried out using the MOS obtained from the subjective test. This investigation also provided the inspiration and foundation for designing the following QoE-driven VHO algorithm.

This work has also contributed to the research community in the following publication [4].

This work is presented in Chapter 3.

- 2) Development of QoE-driven VHO algorithm**

Furthermore, this work has contributed to the development of a QoE-driven VHO algorithm. The QoE-driven VHO algorithm aims to provide and maintain acceptable QoE of mobile video services for mobile users regardless of the type of video content being delivered. Following this development, the performance evaluation of the QoE-driven VHO algorithm was carried out. Within this evaluation, the performance of the QoE-driven VHO algorithm was compared with the MIH default bandwidth-based VHO algorithm. The results show that the QoE-driven VHO algorithm can effectively provide and maintain an acceptable QoE of

mobile video services for mobile users. Furthermore, the QoE-driven VHO algorithm can provide and maintain as superior QoE of mobile video services than the bandwidth-based VHO algorithm.

Overall, this work has been contributed to research community in the following publication [5]. The work is presented in Chapter 4.

3) Design basic concept of UCQoE VHO management framework

This work has contributed to the design of the basic UCQoE VHO management framework. The basic UCQoE VHO management framework aims to provide and maintain the QoE of mobile video services for mobile users based on their actual requirements. In the basic UCQoE VHO management framework, two requirements are defined based on whether the mobile user is concerned with the cost of the mobile data or whether the user instead prioritises the QoE of mobile video services. Hence, the user preferences function provides two options representing the two defined requirements to allow mobile users to select depending on their actual requirements. Furthermore, two VHO algorithms are applied in the basic UCQoE VHO management framework to make the handover decision. The results of the performance evaluation show that the basic UCQoE VHO management framework can manage VHO algorithms to provide and maintain QoE of mobile video services as the actual requirements of the mobile users.

This work has been contributed to the research community in the following publication [6]. The work is presented in Chapter 5.

4) Development of advanced UCQoE VHO management framework

In addition to the above contributions, this work has also contributed to the development of an advanced UCQoE VHO management framework. The advanced UCQoE VHO management framework is developed based on the basic UCQoE VHO management framework and the categories: Cost-free, Acceptable QoE and Prime QoE, to encompass the

requirements of all mobile users. Moreover, three VHO algorithms are applied to manage VHO according to the mobile user's actual requirement. Depending on the performance evaluation, the proposed framework can maintain the QoE of the mobile video services with different types of content. Moreover, the proposed framework is able to satisfy the mobile user's different requirements at different times. Lastly, the proposed framework can control the cost of the network accessing services depending on the mobile user's actual requirements.

Additionally, this work plans to submit to IEEE Transactions on Mobile Computing. The work is presented in Chapter 5.

6.3. Limitations of Current Work

In spite of the advanced and contributions this work has made, the work carried out in this project has several limitations that should be addressed in future studies.

1) Simulation based performance evaluation

The performance of the proposed algorithm and framework in this project are evaluated in simulated heterogeneous wireless networks using the NS2 simulator. This approach has benefits such as being fast, repeatable, easy to configure and easy to customise. Additionally, in a simulated heterogeneous wireless network, many parameters such as packet loss and bandwidth are able to be controlled. However, while the simulation tests are much more economical than real-time tests that include computing devices and communication interfaces, the reliability and consistency of the simulation tests is dependent on the quality and accuracy of the applied simulation model, whereas network conditions are in real heterogeneous wireless networks are unpredictable.

2) Limited wireless access technologies

Due to the limitations of NS2 simulator, only the UMTS network and WiFi network are applied in simulations to evaluate the proposed algorithm and framework. However, the NS2 simulator and MIH standard do not support LTE and LTE-advanced which are recent wireless access technologies that provide higher downloading and uploading speeds. Furthermore, the WiMAX network could be implemented in simulations to evaluate the performance of proposed algorithm and framework.

3) Limited QoE prediction model

In addition to the previous limitation, the reference-free QoE prediction model is applied in the proposed algorithm and framework to predict the QoE of mobile video services. While this reference-free QoE prediction model is very suitable for measuring QoE of mobile video in real-time, the accuracy and reliability of the predicted QoE of mobile video services is dependent on the quality and compatibility of the QoE prediction model. Furthermore, this QoE prediction model is designed to predict the QoE of CIF video. Nevertheless, as the screen resolution of modern devices is continually increasing, the QoE prediction model with better compatibility could be used to improve the accuracy of the predicted QoE of mobile video services.

4) Limited validation of the work

Although the proposed algorithm and framework has been validated through large amounts of simulations with different scenarios, if the proposed algorithm and framework were to be tested in a real time testbed, the validation could be considered more reliable.

6.4. Suggestions for Future Work

After conducting this study, there are three main aspects of the research that could be improved and extended further in future work.

1) Performance evaluation and simulation with more complicated simulation scenarios

The proposed algorithm and framework were evaluated by several simulations. However, the simulation scenarios could be designed with more complexity to simulate the environment closer to that of a real heterogeneous wireless network. There are two ways to increase the complexity of simulation scenario: Firstly, more WiFi networks could be implemented to increase the complexity of heterogeneous wireless network so that it could validate whether the proposed algorithm and framework is able to select an appropriate target network from many candidate networks to satisfy the requirements of the mobile user. Secondly, more mobile users could be incorporated in the simulations to investigate whether the proposed algorithm and framework could balance the utilisation of network resources.

2) Performance evaluation with real testbed

Due to the limitations of experiment facilities, the performance of the proposed algorithm and framework have not able to be evaluated on a real testbed in this project. Although the concept of the proposed algorithm and framework have been validated through simulations, it would be better to evaluate the proposed algorithm and framework on a real testbed as network conditions and interferences are unpredictable in a real heterogeneous wireless network. Moreover, the evaluation results obtained from experiments on a real testbed would be more reliable.

3) Further development of compatibility with other type of mobile services

In this project, the proposed algorithm and framework are designed to provide and maintain the QoE of mobile video services which dominate the wireless network resource of heterogeneous wireless networks. However, there is another popular mobile service which need to be considered seriously – mobile gaming services. The proportion of mobile games has significantly increased in recent years, and will continue to increase in the future [103].

Due to this trend, if the proposed algorithm and framework could be developed to provide and maintain QoE of mobile gaming services for mobile users as the actual requirements of the mobile users, the compatibility and effectiveness of the proposed algorithm and framework could be improved. Furthermore, other popular mobile services also could be considered in the development of the UCQoE VHO management framework to satisfy mobile users.

6.5. Conclusions

Motivated by the exponential growth of mobile video services over heterogeneous wireless networks, this project was initiated to investigate and understand the QoE of the mobile video service and its relationship with network and video parameters. Then, based on the detailed understanding of the relationship between the QoE of mobile video services, network parameters and video parameters, a QoE-driven VHO algorithm has been designed to provide and maintain the acceptable QoE of mobile video services for mobile users in heterogeneous wireless network. Furthermore, the UCQoE VHO management framework has been developed to provide and maintain QoE of mobile video services based on the acquisition of the actual requirements of the mobile user.

Overall, the novelty in this work are QoE-driven VHO algorithm and the UCQoE VHO management framework. Firstly, the QoE-driven VHO algorithm is designed to make the handover decision based on the acceptable QoE that made more intelligently than simply selecting the best QoE. Secondly, the UCQoE VHO management framework implements the user preferences function to acquire the actual requirements of the mobile users on QoE of the mobile video service. Depending on the actual requirements of the mobile user, the UCQoE VHO management framework selects a corresponding VHO algorithm to provide and maintain the QoE of mobile video services for the mobile user.

In summary, the outcome of this research could be used as building blocks to create a foundation for future work in this area. Although the performance of the proposed algorithm and framework needs to be further evaluated with complicated simulation scenarios, a real testbed and highly intelligent QoE prediction model, before to be applied for commercial purpose; the UCQoE VHO management framework still represents huge potential in its further development for providing and maintaining a consistent QoE across different mobile services, for different mobile users with different requirements at different times.

References

- [1] H. T. C. Ltd, "Mobile Video Report: Video a Key Driver of Mobile Market Value," Shanghai, China, 2016, Available: <http://www.huawei.com/en/news/2016/6/mobile-video-report-white-paper>.
- [2] Cisco. (2017, 28 March). *Cisco Visual Networking Index: Global Mobile Data Traffic Forecast Update, 2016–2021 White Paper*. Available: <http://www.cisco.com/c/en/us/solutions/collateral/service-provider/visual-networking-index-vni/mobile-white-paper-c11-520862.html>
- [3] Cisco. (2016, 29 March). *White paper: Cisco VNI Forecast and Methodology, 2015-2020*. Available: <http://www.cisco.com/c/en/us/solutions/collateral/service-provider/visual-networking-index-vni/complete-white-paper-c11-481360.html>
- [4] L. Liu, L. Sun, E. Ifeachor, and I.-H. Mkwawa, "Congestion Control Algorithm and Performance Analysis of Voice and Video Call over Skype," presented at the Collaborative European Research Conference, Cork, Ireland, 2013.
- [5] L. Liu, L. Sun, and E. Ifeachor, "A QoE-driven vertical handover algorithm based on media independent handover framework," in *Wireless and Mobile Computing, Networking and Communications (WiMob), 2015 IEEE 11th International Conference on*, 2015, pp. 51-58.
- [6] L. Liu, L. Sun, and E. Ifeachor, "User-centric QoE-driven vertical handover framework in heterogeneous wireless networks," in *Wireless and Mobile Computing, Networking and Communications (WiMob), 2016 IEEE 12th International Conference on*, 2016, pp. 1-8: IEEE.
- [7] B. R. Chandavarkar and G. R. M. Reddy, "Survey Paper: Mobility Management in Heterogeneous Wireless Networks," *Procedia Engineering*, vol. 30, no. 0, pp. 113-123, 2012.
- [8] J. Marquez-Barja, C. T. Calafate, J. C. Cano, and P. Manzoni, "An overview of vertical handover techniques: Algorithms, protocols and tools," (in English), *Computer Communications*, Review vol. 34, no. 8, pp. 985-997, Jun 2011.
- [9] M. Zekri, B. Jouaber, and D. Zeglache, "A review on mobility management and vertical handover solutions over heterogeneous wireless networks," *Computer Communications*, vol. 35, no. 17, pp. 2055-2068, 2012.
- [10] S. Frattasi, H. Fathi, F. H. Fitzek, K. Chung, and R. Prasad, "4G: A User-Centric System," in *Mobile e-Conference (Me)*, 2004.
- [11] R. Stankiewicz and A. Jajszczyk, "A survey of QoE assurance in converged networks," *Computer Networks*, vol. 55, no. 7, pp. 1459-1473, 2011.
- [12] U. Varshney, "4G Wireless Networks: Past Vision, Current Reality and Future," *IT Professional*, vol. PP, no. 99, pp. 1-1, 2012.
- [13] D. Saha, A. Mukherjee, I. S. Misra, and M. Chakraborty, "Mobility support in IP: a survey of related protocols," *Network, IEEE*, vol. 18, no. 6, pp. 34-40, 2004.
- [14] I. F. Akyildiz, X. Jiang, and S. Mohanty, "A survey of mobility management in next-generation all-IP-based wireless systems," *Wireless Communications, IEEE*, vol. 11, no. 4, pp. 16-28, 2004.
- [15] C. Perkins, "IP Mobility Support for IPv4," *RFC 5944*, November 2010 2010.
- [16] C. Perkins, "Mobility Support in IPv6," *RFC 6275*, 2011.
- [17] I. Al-Surmi, M. Othman, and B. M. Ali, "Mobility management for IP-based next generation mobile networks: Review, challenge and perspective," (in English),

- Journal of Network and Computer Applications*, Review vol. 35, no. 1, pp. 295-315, Jan 2012.
- [18] R. Koodli, "Fast Handovers for Mobile IPv6," *RFC 4068*, 2005.
 - [19] N. P. Singh and B. Singh, "Performance Analysis of IPv6-Based Handovers in Wireless Heterogeneous Networks," presented at the Devices and Communications (ICDeCom), 2011 International Conference on, 24-25 Feb. 2011, 2011.
 - [20] L. Dimopoulou, G. Leoleis, and I. O. Venieris, "Fast handover support in a WLAN environment: challenges and perspectives," *Network, IEEE*, vol. 19, no. 3, pp. 14-20, 2005.
 - [21] H. Soliman, "Hierarchical Mobile IPv6 (HMIPv6) Mobility Management," *RFC 5380*, 2008.
 - [22] H. Soliman, L. Bellier, and K. E. Malki, "Hierarchical mobile IPv6 mobility management (HMIPv6)," *RFC 4140*, 2005.
 - [23] K. L. S. Gundavelli, V. Devarapalli, K. Chowdhury and B. Patil, "Proxy Mobile IPv6," *RFC 5213*, 2008.
 - [24] J. Kempf, "Goals for Network-Based Localized Mobility Management (NETLMM)," *RFC 4831*, 2007.
 - [25] J. Kempf, "Problem Statement for Network-Based Localized Mobility Management (NETLMM)," *RFC 4830*, 2007.
 - [26] J. H. Lee, J. M. Bonnin, I. You, and T. M. Chung, "Comparative Handover Performance Analysis of IPv6 Mobility Management Protocols," (in English), *Ieee Transactions on Industrial Electronics*, Article vol. 60, no. 3, pp. 1077-1088, Mar 2013.
 - [27] C. Makaya and S. Pierre, "An Analytical Framework for Performance Evaluation of IPv6-Based mobility Management Protocols," *Wireless Communications, IEEE Transactions on*, vol. 7, no. 3, pp. 972-983, 2008.
 - [28] K. Ki-Sik, L. Wonjun, H. Youn-Hee, S. Myung-Ki, and Y. HeungRyeol, "Mobility management for all-IP mobile networks: mobile IPv6 vs. proxy mobile IPv6," *Wireless Communications, IEEE*, vol. 15, no. 2, pp. 36-45, 2008.
 - [29] Y. Kim, S. Pack, C. G. Kang, and S. Park, "An enhanced information server for seamless vertical handover in IEEE 802.21 MIH networks," *Computer Networks*, vol. 55, no. 1, pp. 147-158, 2011.
 - [30] G. Lampropoulos, A. K. Salkintzis, and N. Passas, "Media-independent handover for seamless service provision in heterogeneous networks," *Communications Magazine, IEEE*, vol. 46, no. 1, pp. 64-71, 2008.
 - [31] K. Taniuchi *et al.*, "IEEE 802.21: Media independent handover: Features, applicability, and realization," *Communications Magazine, IEEE*, vol. 47, no. 1, pp. 112-120, 2009.
 - [32] A. De La Oliva, A. Banchs, I. Soto, T. Melia, and A. Vidal, "An overview of IEEE 802.21: media-independent handover services," *Wireless Communications, IEEE*, vol. 15, no. 4, pp. 96-103, 2008.
 - [33] O. Khattab and O. Alani, "Survey on Media Independent Handover (MIH) Approaches in Heterogeneous Wireless Networks," in *Wireless Conference (EW), Proceedings of the 2013 19th European*, 2013, pp. 1-5: VDE.
 - [34] X. Li, F. Liu, Z. Feng, G. Xu, and Z. Fu, "A novel optimized vertical handover framework for seamless networking integration in cyber-enabled systems," *Future Generation Computer Systems*, 2017.
 - [35] N. Omheni, F. Zarai, M. S. Obaidat, and L. Kamoun, "Optimized MIH-assisted P-NEMO design for vertical handover over heterogeneous network mobility," in

- Communications (ICC), 2014 IEEE International Conference on*, 2014, pp. 2879-2884: IEEE.
- [36] E. Stevens-Navarro, L. Yuxia, and V. W. S. Wong, "An MDP-Based Vertical Handoff Decision Algorithm for Heterogeneous Wireless Networks," *Vehicular Technology, IEEE Transactions on*, vol. 57, no. 2, pp. 1243-1254, 2008.
- [37] K. Won-Ik, L. Bong-ju, S. Jae-Su, S. Yeon-Seung, and K. Yeong-Jin, "Ping-Pong Avoidance Algorithm for Vertical Handover in Wireless Overlay Networks," presented at the Vehicular Technology Conference, 2007. VTC-2007 Fall. 2007 IEEE 66th, Sept. 30 2007-Oct. 3 2007, 2007.
- [38] X. Yan, Y. Ahmet Şekercioğlu, and S. Narayanan, "A survey of vertical handover decision algorithms in Fourth Generation heterogeneous wireless networks," *Computer Networks*, vol. 54, no. 11, pp. 1848-1863, 2010.
- [39] S. Goudarzi, W. H. Hassan, M. H. Anisi, and A. Soleymani, *A Comparative Review of Vertical Handover Decision-Making Mechanisms in Heterogeneous Wireless Networks* (2015). 2015.
- [40] A. Ahmed, L. M. Boulahia, Gai, x, and D. ti, "Enabling Vertical Handover Decisions in Heterogeneous Wireless Networks: A State-of-the-Art and A Classification," *Communications Surveys & Tutorials, IEEE*, vol. 16, no. 2, pp. 776-811, 2014.
- [41] M. Kassar, B. Kervella, and G. Pujolle, "Architecture of an intelligent inter-system handover management scheme," in *Future generation communication and networking (fgcn 2007)*, 2007, vol. 1, pp. 332-337: IEEE.
- [42] M. Alzubi, A. Amr, and M. Anan, "An Efficient Handover Technique for 4G Networks," presented at the Next Generation Mobile Applications, Services and Technologies (NGMAST), 2010 Fourth International Conference on, 27-29 July 2010, 2010.
- [43] A. H. Zahran and B. Liang, "Performance evaluation framework for vertical handoff algorithms in heterogeneous networks," in *Communications, 2005. ICC 2005. 2005 IEEE International Conference on*, 2005, vol. 1, pp. 173-178: IEEE.
- [44] Y. Wang, J. Yuan, Y. Zhou, G. Li, and P. Zhang, "Vertical handover decision in an enhanced media independent handover framework," in *Wireless Communications and Networking Conference, 2008. WCNC 2008. IEEE*, 2008, pp. 2693-2698: IEEE.
- [45] A. Dutta *et al.*, "Seamless proactive handover across heterogeneous access networks," *Wireless Personal Communications*, vol. 43, no. 3, pp. 837-855, 2007.
- [46] T. Inzerilli, A. M. Vegni, A. Neri, and R. Cusani, "A location-based vertical handover algorithm for limitation of the ping-pong effect," in *Networking and Communications, 2008. WIMOB'08. IEEE International Conference on Wireless and Mobile Computing*, 2008, pp. 385-389: IEEE.
- [47] S. Lee, K. Sriram, K. Kim, Y. H. Kim, and N. Golmie, "Vertical handoff decision algorithms for providing optimized performance in heterogeneous wireless networks," *IEEE transactions on vehicular technology*, vol. 58, no. 2, pp. 865-881, 2009.
- [48] P. Nay and C. Zhou, "Vertical handoff decision algorithm for integrated UMTS and LEO satellite networks," in *Communications and Mobile Computing, 2009. CMC'09. WRI International Conference on*, 2009, vol. 2, pp. 180-184: IEEE.
- [49] F. Siddiqui and S. Zeadally, "Mobility management across hybrid wireless networks: Trends and challenges," *Computer Communications*, vol. 29, no. 9, pp. 1363-1385, 2006.
- [50] S. Wang, C. Fan, C.-H. Hsu, Q. Sun, and F. Yang, "A vertical handoff method via self-selection decision tree for internet of vehicles," *IEEE Systems Journal*, vol. 10, no. 3, pp. 1183-1192, 2016.

- [51] A. M. Miyim, M. Ismail, and R. Nordin, "User-Driven Network Selection during Vertical Handover in 4G Networks," *Journal of Communications Technology, Electronics and Computer Science*, vol. 10, pp. 1-10, 2017.
- [52] A. Miyim, M. Ismail, and R. Nordin, "Vertical handover solutions over LTE-advanced wireless networks: an overview," *Wireless personal communications*, vol. 77, no. 4, pp. 3051-3079, 2014.
- [53] Q. T. Nguyen-Vuong, N. Agoulmine, and Y. Ghamri-Doudane, "Terminal-Controlled Mobility Management in Heterogeneous Wireless Networks," *Communications Magazine, IEEE*, vol. 45, no. 4, pp. 122-129, 2007.
- [54] Q.-T. Nguyen-Vuong, N. Agoulmine, and Y. Ghamri-Doudane, "A user-centric and context-aware solution to interface management and access network selection in heterogeneous wireless environments," *Computer Networks*, vol. 52, no. 18, pp. 3358-3372, 2008.
- [55] A. Sehgal and R. Agrawal, "QoS based network selection scheme for 4G systems," *Consumer Electronics, IEEE Transactions on*, vol. 56, no. 2, pp. 560-565, 2010.
- [56] M. Kassar, B. Kervella, and G. Pujolle, "An overview of vertical handover decision strategies in heterogeneous wireless networks," *Computer Communications*, vol. 31, no. 10, pp. 2607-2620, 2008.
- [57] S. Qingyang and A. Jamalipour, "Network selection in an integrated wireless LAN and UMTS environment using mathematical modeling and computing techniques," *Wireless Communications, IEEE*, vol. 12, no. 3, pp. 42-48, 2005.
- [58] E. Stevens-Navarro and V. W. S. Wong, "Comparison between Vertical Handoff Decision Algorithms for Heterogeneous Wireless Networks," presented at the Vehicular Technology Conference, 2006. VTC 2006-Spring. IEEE 63rd, 7-10 May 2006, 2006.
- [59] S. Goudarzi *et al.*, "ABC-PSO for vertical handover in heterogeneous wireless networks," *Neurocomputing*, 2017.
- [60] M. Khan, A. Ahmad, S. Khalid, S. H. Ahmed, S. Jabbar, and J. Ahmad, "Fuzzy based multi-criteria vertical handover decision modeling in heterogeneous wireless networks," *Multimedia Tools and Applications*, pp. 1-26, 2017.
- [61] X. Liu, J. Ling-ge, and H. Chen, "A Novel Fuzzy Logic Vertical Handoff Algorithm with Aid of Differential Prediction and Pre-Decision Method," in *Communications, 2007. ICC '07. IEEE International Conference on*, 2007, pp. 5665-5670.
- [62] P. N. Tran and N. Boukhatem, "Comparison of MADM decision algorithms for interface selection in heterogeneous wireless networks," in *Software, Telecommunications and Computer Networks, 2008. SoftCOM 2008. 16th International Conference on*, 2008, pp. 119-124: IEEE.
- [63] M. M. Alkhawlani, "MCDM based joint admission control for heterogeneous wireless networks," in *Computer Engineering & Systems (ICCES), 2012 Seventh International Conference on*, 2012, pp. 3-8: IEEE.
- [64] T. Taleb and K. B. Letaief, "A cooperative diversity based handoff management scheme," *IEEE Transactions on Wireless Communications*, vol. 9, no. 4, 2010.
- [65] S.-Y. Chou, Y.-H. Chang, and C.-Y. Shen, "A fuzzy simple additive weighting system under group decision-making for facility location selection with objective/subjective attributes," *European Journal of Operational Research*, vol. 189, no. 1, pp. 132-145, 2008.
- [66] Z. Wenhui, "Handover decision using fuzzy MADM in heterogeneous networks," presented at the Wireless Communications and Networking Conference, 2004. WCNC. 2004 IEEE, 21-25 March 2004, 2004.

- [67] K. Savitha and C. Chandrasekar, "Vertical Handover decision schemes using SAW and WPM for Network selection in Heterogeneous Wireless Networks," *arXiv preprint arXiv:1109.4490*, 2011.
- [68] K. Savitha and C. Chandrasekar, "Trusted network selection using SAW and TOPSIS algorithms for heterogeneous wireless networks," *arXiv preprint arXiv:1108.0141*, 2011.
- [69] L. Sheng-mei, P. Su, and X. Ming-hai, "An improved TOPSIS vertical handoff algorithm for heterogeneous wireless networks," in *Communication Technology (ICCT), 2010 12th IEEE International Conference on*, 2010, pp. 750-754: IEEE.
- [70] M. M. Alkhwilani, K. A. Alsalem, and A. A. Hussein, "Multi-criteria vertical handover by TOPSIS and fuzzy logic," in *Communications and Information Technology (ICCIT), 2011 International Conference on*, 2011, pp. 96-102: IEEE.
- [71] K. Savitha and D. Chandrasekar, "Network selection using TOPSIS in vertical handover decision schemes for heterogeneous wireless networks," *arXiv preprint arXiv:1106.2402*, 2011.
- [72] I. Chamodrakas and D. Martakos, "A utility-based fuzzy TOPSIS method for energy efficient network selection in heterogeneous wireless networks," *Applied Soft Computing*, vol. 12, no. 7, pp. 1929-1938, 2012.
- [73] S. Qingyang and A. Jamalipour, "A network selection mechanism for next generation networks," presented at the Communications, 2005. ICC 2005. 2005 IEEE International Conference on, 16-20 May 2005, 2005.
- [74] J. Fu, J. Wu, J. Zhang, L. Ping, and Z. Li, "A novel AHP and GRA based handover decision mechanism in heterogeneous wireless networks," in *International Conference on Information Computing and Applications*, 2010, pp. 213-220: Springer.
- [75] J. S. Wu, S. F. Yang, and B. J. Hwang, "A terminal - controlled vertical handover decision scheme in IEEE 802.21 - enabled heterogeneous wireless networks," *International Journal of Communication Systems*, vol. 22, no. 7, pp. 819-834, 2009.
- [76] A. Bhuvaneshwari and E. G. D. P. Raj, "An overview of vertical handoff decision making algorithms," *International Journal of Computer Network and Information Security*, vol. 4, no. 9, p. 55, 2012.
- [77] M. Archana and V. Sujatha, "Application of fuzzy moora and gra in multi-criterion decision making problems," *International Journal of Computer Applications*, vol. 53, no. 9, 2012.
- [78] G. Mahardhika, M. Ismail, and R. Nordin, "Vertical handover decision algorithm using multicriteria metrics in heterogeneous wireless network," *journal of computer networks and communications*, vol. 2015, 2015.
- [79] O. Markaki, D. Charilas, and D. Nikitopoulos, "Enhancing Quality of Experience in Next Generation Networks Through Network Selection Mechanisms," presented at the Personal, Indoor and Mobile Radio Communications, 2007. PIMRC 2007. IEEE 18th International Symposium on, 3-7 Sept. 2007, 2007.
- [80] J. S. Jacob and K. G. Preetha, "A QoS and QoE collaborative scheme for effective network selection in 4G communication systems," presented at the Recent Advances in Computing and Software Systems (RACSS), 2012 International Conference on, 25-27 April 2012, 2012.
- [81] S. Baraković and L. Skorin-Kapov, "Survey and challenges of QoE management issues in wireless networks," *Journal of Computer Networks and Communications*, vol. 2013, 2013.
- [82] M. Kim, "QoE-Aware Mobility Management Scheme," *Journal of information and communication convergence engineering*, vol. 14, no. 3, pp. 137-146, 2016.

- [83] H. S. Kim, E. Kim, and H. Kim, "QoE-driven Wi-Fi selection mechanism for next generation smartphones," in *Enabling Technologies for Smartphone and Internet of Things (ETSIoT), 2012 First IEEE Workshop on*, 2012, pp. 13-18: IEEE.
- [84] M. J. Piran, N. Tran, D. Suh, J. B. Song, C. S. Hong, and Z. Han, "QoE-Driven Channel Allocation and Handoff Management for Seamless Multimedia in Cognitive 5G Cellular Networks," *IEEE Transactions on Vehicular Technology*, 2016.
- [85] J. Jailton, T. Carvalho, W. Valente, C. Natalino, R. Frances, and K. Dias, "A quality of experience handover architecture for heterogeneous mobile wireless multimedia networks," *Communications Magazine, IEEE*, vol. 51, no. 6, pp. 152-159, 2013.
- [86] C. Quadros *et al.*, "A quality of experience handover system for heterogeneous multimedia wireless networks," in *Computing, Networking and Communications (ICNC), 2013 International Conference on*, 2013, pp. 1064-1068.
- [87] J. Jailton, T. Carvalho, W. Valente, C. Natalino, R. Frances, and K. Dias, "A quality of experience handover architecture for heterogeneous mobile wireless multimedia networks," *IEEE Communications Magazine*, vol. 51, no. 6, pp. 152-159, 2013.
- [88] C. Quadros *et al.*, "A quality of experience handover system for heterogeneous multimedia wireless networks," in *Computing, Networking and Communications (ICNC), 2013 International Conference on*, 2013, pp. 1064-1068: IEEE.
- [89] R. Trestian, O. Ormond, and G.-M. Muntean, "Enhanced power-friendly access network selection strategy for multimedia delivery over heterogeneous wireless networks," *IEEE Transactions on Broadcasting*, vol. 60, no. 1, pp. 85-101, 2014.
- [90] K. Piamrat, H. Park, K. Deep Singh, and C. Viho, "QoE - Based Network Selection in Heterogeneous Environments," *Quality of Experience Engineering for Customer Added Value Services*, pp. 245-265, 2014.
- [91] H. Zhang, X. Wen, Z. Lu, and Z. Hu, "QoE-based reduction handover delays for multimedia application in IEEE 802.11 networks," *Communications Letters, IEEE*, vol. PP, no. 99, pp. 1-1, 2015.
- [92] K. Piamrat, A. Ksentini, C. Viho, and J. Bonnin, "QoE-aware vertical handover in wireless heterogeneous networks," in *Wireless Communications and Mobile Computing Conference (IWCMC), 2011 7th International*, 2011, pp. 95-100.
- [93] K. Piamrat, A. Ksentini, C. Viho, and J. Bonnin, "QoE-based network selection for multimedia users in IEEE 802.11 wireless networks," in *Local Computer Networks, 2008. LCN 2008. 33rd IEEE Conference on*, 2008, pp. 388-394.
- [94] B. Sat and B. W. Wah, "Evaluation of conversational voice communication quality of the Skype, Google-talk, Windows Live, and Yahoo Messenger VoIP Systems," in *Multimedia Signal Processing, 2007. MMSP 2007. IEEE 9th Workshop on*, 2007, pp. 135-138: IEEE.
- [95] T.-Y. Huang, P. Huang, K.-T. Chen, and P.-J. Wang, "Could Skype be more satisfying? a QoE-centric study of the FEC mechanism in an internet-scale VoIP system," *IEEE Network*, vol. 24, no. 2, 2010.
- [96] X. Zhang, Y. Xu, H. Hu, Y. Liu, Z. Guo, and Y. Wang, "Profiling skype video calls: Rate control and video quality," in *INFOCOM, 2012 Proceedings IEEE*, 2012, pp. 621-629: IEEE.
- [97] L. De Cicco and S. Mascolo, "A mathematical model of the Skype VoIP congestion control algorithm," *IEEE Transactions on Automatic Control*, vol. 55, no. 3, pp. 790-795, 2010.
- [98] L. De Cicco, S. Mascolo, and V. Palmisano, "Skype video responsiveness to bandwidth variations," in *Proceedings of the 18th International Workshop on Network and Operating Systems Support for Digital Audio and Video*, 2008, pp. 81-86: ACM.

- [99] L. De Cicco, S. Mascolo, and V. Palmisano, "Skype video congestion control: An experimental investigation," *Computer Networks*, vol. 55, no. 3, pp. 558-571, 2011.
- [100] A. Khan, L. Sun, E. Jammeh, and E. Ifeakor, "Quality of experience-driven adaptation scheme for video applications over wireless networks," *IET communications*, vol. 4, no. 11, pp. 1337-1347, 2010.
- [101] F. Kuipers, R. Kooij, D. De Vleeschauwer, and K. Brunnström, "Techniques for measuring quality of experience," in *International Conference on Wired/Wireless Internet Communications*, 2010, pp. 216-227: Springer.
- [102] T. Vasileva-Stojanovska and V. Trajkovik, "Modeling a Quality of Experience aware distance educational system," in *ICT Innovations 2013*: Springer, 2014, pp. 45-55.
- [103] Newzoo. (2016, 27 March). *Global Games Market Report*. Available: <https://newzoo.com/insights/articles/global-games-market-reaches-99-6-billion-2016-mobile-generating-37/>

Appendix 1

Congestion Control Algorithm and Performance Analysis of Voice and Video Call over Skype

Li Liu, Lingfen Sun, Emmanuel Ifeachor and Is-Haka Mkwawa

School of Computing and Mathematics, Plymouth University, UK
{li.liu, L.Sun, E.Ifeachor, is-haka.mkwawa}@plymouth.ac.uk

Abstract

Video call has gained more momentum in recent Voice/Video over Internet Protocol (VoIP) applications. However, due to its large bandwidth requirement, it is challenging to develop efficient congestion control mechanisms for better perceived video quality when compared with voice call. In this paper, we investigate the congestion control mechanism of Skype, one of the most popular VoIP tools, for voice and video calls in terms of Quality of Service (QoS) and Quality of Experience (QoE). Preliminary results show that Skype uses different category-based congestion control mechanisms for voice and video calls in order to react to adverse network conditions. The congestion control mechanism only takes video contents into consideration when available bandwidth significantly changes. Nevertheless, the congestion control mechanism does not consider video contents when packet loss rate changes. The category-based congestion control mechanism can recover the QoE of voice calls more effectively than video calls under adverse network conditions.

Keywords

Skype, VoIP, Congestion Control Mechanism, QoS, QoE

1. Introduction

In recent years, VoIP communication has become more popular. There are many VoIP applications such as Skype, Google Talk and Yahoo Messenger (Sat *et al.* 2007). Skype is a Peer-to-Peer (P2P) VoIP application and it is one of the most popular and successful VoIP applications in the world with the largest amount of users reaching a peak of 45,469,977 concurrent users online in 2012 (Skype, 2013). Due to Skype's proprietary nature, its advanced congestion control mechanisms are unknown in the public domain. Therefore, understanding the congestion control mechanisms of Skype's voice and video quality may help to develop efficient congestion control mechanisms in the future. Thus this has attracted many researchers to investigate Skype's built-in congestion control mechanism and Forward Error Correction (FEC) algorithm in order to better understand the inherent problems of VoIP and the nature of Skype. This paper aims to investigate the Skype's proprietary congestion control mechanisms and the performance of Skype's voice and video call in terms of QoS and QoE. The QoS will be investigated depending on the payload size, interarrival time and throughput. The QoE is defined by ITU (International Telecommunication Union) as "*The overall acceptability of an application or service, as perceived subjectively by the end-user*" (Huang *et al.*

2010). Mean Opinion Score (MOS), from 1 to 5, is used to represent the QoE from bad to excellent. Currently Skype applies SILK codec to encode speech and uses multiple versions of video codecs to encode video such as VP6, VP7 and VP8 (Zhang *et al.* 2012 and Goudarzi *et al.* 2011).

The contribution of this paper includes three main features of Skype congestion control mechanism: (1) Skype applies category-based congestion control mechanism for voice calls and video calls to react adverse network conditions. (2) The category-based congestion control mechanism only takes video content into account when the available bandwidth changes in the network. The category-based congestion control mechanism will increase the payload size of fast motion video quicker than slow motion video, when available bandwidth significantly increases. Nevertheless video contents would not be considered by the congestion control mechanism when packet loss rate changes. (3) The category-based congestion control mechanism recovers the QoE of voice calls more effectively than video calls. The rest of this paper is organized as follows. The related work is summarized in Section 2, and Section 3 introduces the testbed and experiments carried out. Results analysis is discussed in Section 4. In Section 5, the conclusion and future work are presented.

2. Related work

Several researchers have investigated the congestion control mechanisms of Skype. Huang *et al.* investigated Skype's FEC mechanism which is used to effectively recover quality through encapsulating several data into one FEC block (Huang *et al.* 2010). Zhang *et al.* indicated that Skype reduced sending rate and video bit rate with the increase of packet loss rate (Zhang *et al.* 2012). They also found out that Skype applied two models for FEC mechanisms based on the threshold of packet loss rate (10%). De Cicco *et al.* proposed a model of congestion control mechanism for Skype voice calls in terms of packet loss rate and available bandwidth (De Cicco *et al.* 2010). Furthermore, De Cicco *et al.* also found out that Skype was TCP-friendly (De Cicco *et al.* 2011). Zhu investigated the traffic characteristics and user experience of Skype under different kinds of network such as Local Area Network (LAN), Wireless Local Area Network (WLAN) and Worldwide Interoperability for Microwave Access (WiMAX) (Zhu, 2011). Exarchakos *et al.* found that Skype could recover lost packet efficiently when packet loss rate was lower than 10% (Exarchakos *et al.* 2011). Liotta *et al.* investigated the QoE management for Skype video stream and found out that the QoE management should consider more human-centric (Liotta *et al.* 2012). Xu *et al.* investigate and compare the performance and design choices of Google+, iChat and Skype (Xu *et al.* 2011). However, most of the previous researches on Skype voice and video calls only focused on packet loss rates less than 10%. Furthermore, the investigation on Skype video congestion control mechanisms under different video contents has been ignored. Hence this paper aims to investigate congestion control mechanism based on the packet loss rate from 0% to 20% and the available bandwidth between 100 Kbps and 1700 Kbps. Additionally, this paper also investigates how Skype congestion control mechanism reacts to different video contents under different network conditions. Furthermore, the QoE of voice and video calls under adverse network conditions will be investigated based on human-listened.

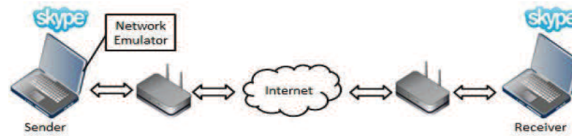

Figure 1: Testbed

3. Testbed and experiments

3.1. Testbed setup

In order to conduct Skype voice and video calls under different network conditions via wireless network, a testbed is set up which consists of two Laptops installed with Windows 7 and two wireless routers (Netgear WGR614v8) connecting to the Internet as shown in Figure 1. Network Emulator for Windows Toolkit (NEWT) is used to emulate different network conditions (NEWT, 2013). It is installed on the 'Sender' laptop. Standard voice samples and video clips are injected into the Skype Sender machine by using Virtual Audio Cable and ManyCam respectively (Virtual Audio Cable, 2013 and ManyCam, 2013). Voice and video traffic are captured by Wireshark. The voice is recorded on the receiver side by Audacity, whereas, the video is recorded by SuperTintin.

3.2. Experiments carried out

Due to low bandwidth requirements of Skype voice calls, the experiments on congestion control mechanism and performance of Skype voice calls were only conducted under different packet loss rates. The packet loss rate is incremented at an interval of 2% after every 1 minute from 0% to 20% in order to investigate how Skype adjusts the sending bit rate, interarrival time and throughput. After reaching 20%, the packet loss will be directly reduced from 20% to 0% in order to investigate whether Skype would immediately readjust its parameters under significant change of network conditions. In this experiment the sample voices 'BRITISH_ENGLISH' from ITU-T P.50 are used in the voice call test and each test lasted for 12 minutes (720 seconds) (ITU-T, 2013).

Similarly, the experiments on Skype video calls under different packet loss rates were conducted as in voice call experiments described above. Considering high bandwidth requirements for video call, we also carried out Skype video call experiments under different available bandwidth conditions. In this experiment, the available bandwidth was decremented by 200 Kbps after every 1 minute from 1700 Kbps to 100 Kbps. After reaching 100 Kbps and waited for 1 minute, the available bandwidth was suddenly increased to 1700 Kbps. This change, known as "square waves", was repeated for three times at the interval of 1 minute. This experiment used three video clips with different motion ('hall', 'foreman' and 'stefan') in order to investigate whether Skype congestion control mechanism took video motion into consideration to adjust its parameters.

Furthermore, in order to investigate the QoE of Skype voice and video calls under adverse network conditions, subjective tests were conducted which involved 20 volunteers to listen to and watch the recorded voice and video calls. They were 10 males and 10 females aged between 18 and 30 years old. Then depending on the average MOS, the QoE of Skype voice calls and video calls under different packet loss rates and available bandwidth was analysed.

4. Results analysis

4.1. Skype voice call

4.1.1. Congestion control mechanism

This subsection will describe the results and analysis of congestion control algorithms for packet loss. The average (the top half) and detail (the bottom half) results are shown as Figure 2 and 3. As shown in Figure 2 (A), Skype adopted different method to adjust payload size based on four categories of packet loss rate from 0% to 20%.

- **Category 1: [0%, 2%].** Skype kept payload size unchanged between 50 Bytes and 110 Bytes, and the average payload size was as about 80 Bytes.
- **Category 2: [2%, 10%].** Skype used larger range of payload size than the one in Category 1 and kept it unchanged. It is clear that there are two bands of payload size with majority at high band around 200 Bytes and minority at low band around 100 Bytes. This indicates that Skype applied FEC to recover lost packets. The average payload size slightly increased from about 150 Bytes to 175 Bytes.
- **Category 3: [10%, 14%].** Overall trend of average payload size was significantly decreasing with packet loss increasing. However when packet loss rate was unchanging, the payload size increased significantly.

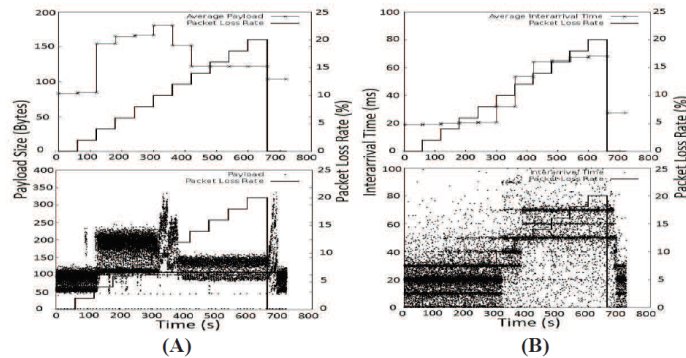

Figure 2: Payload sizes (A) and interarrival time (B) under different packet loss rates

- **Category 4: [14%, 20%]**. Two bands of payload sizes were higher than the bands in the category 1. This indicated that the FEC was still applied but the ratio of redundancy was low than the ratio in Category 2.

As shown in Figure 2 (B), Skype adjusted interarrival time based on the four categories of packet loss rates as shown below.

- **Category 1: [0%, 2%]**. The average interarrival time was about 20ms. Skype used three interarrival times (10ms, 20ms and 30ms) to send packets.
- **Category 2: [2%, 10%]**. The average interarrival time was still about 20ms. Skype started to use other two large interarrival times (40ms and 50ms) to send packets at the same time. Hence, Skype uses five interarrival times at the same time.
- **Category 3: [10%, 14%]**. The average interarrival time was about 30ms. Skype used interarrival times of 30ms, 40ms and 50ms to send most packets at the same time.
- **Category 4: [14%, 20%]**. The average interarrival time was about 60ms. Skype used interarrival times of 50ms, 60ms and 70ms to send packets.

As shown in Figure 3, it is obvious that Skype adjusted throughput based on four categories of packet loss rates. The main thresholds were 2%, 10% and 14%.

- **Category 1: [0%, 2%]**. Skype kept throughput unchanged between around 10 Kbps and 50 Kbps. The average throughput was about 50 Kbps.
- **Category 2: [2%, 10%]**. The average throughput was about 60 Kbps. Skype used larger range of throughput than the one in Category 1 which was around 30 Kbps and 90 Kbps.
- **Category 3: [10%, 14%]**. Skype kept throughput at lower values compared to Category 2. The average throughput decreased to about 45 Kbps.
- **Category 4: [14%, 20%]**. Skype kept throughputs unchanged between about 10 Kbps and 20 Kbps, which was lower than that of Category 1.

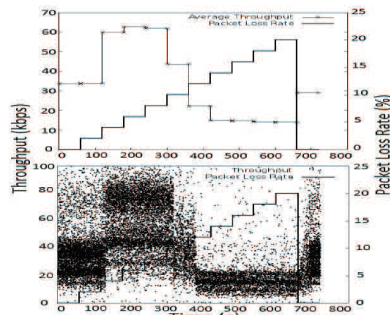

Figure 3: Throughputs under different packet loss rates

Packet loss rate	0%	2%	4%	6%	8%	10%
Average MOS	4.8	4.5	4.25	4.1	3.75	3.5
Packet loss rate	12%	14%	16%	18%	20%	20%-0%
Average MOS	3.35	3.15	2.9	2.3	1.65	3.95

Table 1: The average MOS of Skype voice call under different packet loss rates

4.1.2. QoE analysis of Skype voice call

As shown in Table 1, the QoE of Skype voice calls under packet loss rates from 0% to 10% are good (higher than 3.5). Then MOS decreased with the increase of packet loss rate. However, when packet loss rate directly reduced to 0% from 20%, the QoE of Skype voice call immediately became good. In general, Skype congestion control mechanism could effectively recover the quality of voice calls when packet loss rate is between 0% and 10%. However, when packet loss rate is higher than 10%, the quality of Skype voice calls is significantly degraded.

4.2. Skype video call

4.2.1. Congestion control mechanism for packet loss

The results are shown in the Figure 4 and 5. As shown in Figure 4 (A), the payload size adjustments of Skype video calls with three different motion types were similar. Skype adjusted payload size based on different categories of packet loss rates, especially for the packets containing I frame.

- **Category 1: [0%, 8%].** Skype increased average payload size from about 800 Bytes to 1000 Bytes. Skype kept the range of payload sizes unchanged. However when packet loss rate was between 2% and 8%, payload sizes of some I frame packets were between 1300 Bytes and 1400 Bytes.

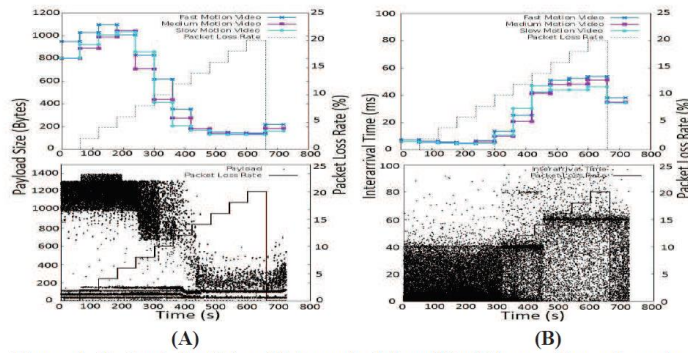

Figure 4: Payload size (A) and interarrival time (B) of Skype video calls under different packet loss rates

- **Category 2: [8%, 14%].** The average payload size was around 1100 Bytes, then significantly reduced to about 200 Bytes. Skype applied the payload sizes of I Frame packets within the larger range of [600 Bytes, 1300 Bytes]. Furthermore, when packet loss rate reached 14%, the range of payload sizes of I frame packets were significantly reduced to [100 Bytes, 300 Bytes].
- **Category 3: [14%, 20%].** Skype kept payload size unchanged in the range of 100 Bytes to 300 Bytes and the average throughput was about 180 Bytes.

As shown in Figure 4 (B), Skype adjusted interarrival time similarly for three video contents that was based on three categories of packet loss rates.

- **Category 1: [0%, 8%].** Skype kept the interarrival times unchanged which were less than 40ms. The average was slightly reduced to about 7ms.
- **Category 2: [8%, 14%].** Skype sent most packets by using the interarrival time of around 40ms. The average interarrival time was significantly increased from about 10ms to 40ms.
- **Category 3: [14%, 20%].** Skype used the interarrival time of around 60ms to send most of packets. The average interarrival time was around 45ms.

As shown in Figure 5, Skype followed the similar trend to adjust the throughput of Skype video calls with different motions. It is obvious that Skype adjusted the throughput based on three categories.

- **Category 1: [0%, 8%].** The average throughput was significantly increased from about 1000 Kbps to 1600 Kbps as packet loss rate increased. Skype used the wide range of throughput, but the dominant throughput was between 250 Kbps and 500 Kbps.
- **Category 2: [8%, 14%].** The average throughput was significantly reduced from about 1700 Kbps to 200 Kbps. Most of the packets were sent by using throughputs of around 200 Kbps.
- **Category 3: [14%, 20%].** The throughput of most packets was around 100 Kbps. However, the average throughput was about 50 Kbps.

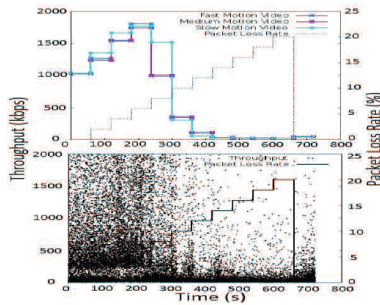

Figure 5: Throughput of Skype video calls under different packet loss rates

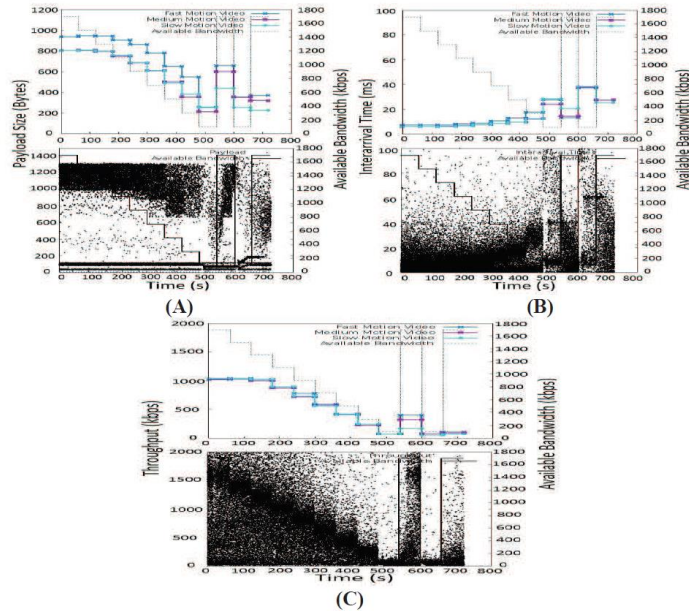

Figure 6: Payload size (A), interarrival time (B) and throughput (C) of Skype video call under different available bandwidth

4.2.2. Congestion control mechanism for available bandwidth

The average (the top half) and detail (the bottom half) results are shown as Figure 6. As shown in Figure 6 (A), when available bandwidth was decreased from 1700 Bytes to 100 Bytes, Skype followed the similar trend to decrease the payload sizes for three different video motions. Skype enlarged the scope of payload size of I frame packets from [1000, 1300] to [700, 1300] with available bandwidth decreasing from 1400 Kbps to 100 Kbps. During the wave changes of available bandwidth, the payload size was recovered immediately when the available bandwidth suddenly increased. Furthermore the payload size of fast motion video increased quicker than the slow motion video. However the second recovery was slower than the first one. As shown in Figure 6 (B), the trends of interarrival time adjustments of Skype video calls with different video motions were similar. When available bandwidth was reduced from 1700 Kbps to 500 Kbps, the average interarrival times were about 10ms. Then Skype increased average interarrival time from about 10ms to 20ms with available bandwidth decreasing. During the square wave change, the first increase of the interarrival time was higher than that in the second increase. As shown in Figure 6 (C), the trends of adjustment of throughput of three video motions were similar. Skype reduced average throughput with available bandwidth decreasing.

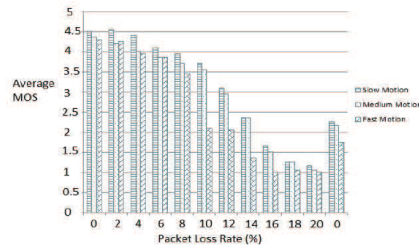

Figure 7: Average MOS of Skype video calls under different packet loss rates

Furthermore, Skype never consumed all available bandwidth. In the first square wave change, Skype significantly increased the throughput from about 90 Kbps to 400 Kbps. Nevertheless, during the second square wave change Skype slightly increased the throughput.

4.2.3. QoE analysis of Skype video call

As shown in Figure 7, the QoE of Skype video calls were degraded with the increase of packet loss rate. When packet loss rate was between 0% and 8%, the QoE was acceptable. The trend of QoE degradation of three Skype video calls was similar, but the Skype video call with fast motion was more affected than the rest. When packet loss rate was directly reduced to 0%, the QoE was slowly recovered.

5. Conclusion

In this paper, we found out that Skype applied category control mechanisms to effectively react to adverse network conditions for voice and video calls. For the Skype voice calls, the category-based congestion control mechanism is based on four categories to adjust the three main parameters under packet loss rate from 0% to 20%: [0%, 2%], [2%, 10%], [10%, 14%] and [14%, 20%]. However, for the Skype video calls, the category-based congestion control mechanism divided three categories of packet loss rate from 0% to 20%: [0%, 8%], [8%, 14%] and [14%, 20%]. The category-based congestion control mechanism only considers video contents when available bandwidth changes. The payload size of fast motion video will be increased quicker than slow motion video, when available bandwidth significantly increases. Nevertheless video contents would not be considered by the congestion control mechanism when packet loss rate changes. The category-based congestion mechanism could recover the QoE of Skype voice calls more efficiently than Skype video calls. We also found that the packet loss rate of 8% was the acceptable threshold service for Skype voice and video calls in terms of QoE.

6. Acknowledgement

Thanks for the Ahmad Asiri's contribution on the testbed setup during his MSc studying at the University.

7. References

- De Cicco, L., & Mascolo, S. (2010). A mathematical model of the Skype VoIP congestion control algorithm. *Automatic Control, IEEE Transactions on*, 55(3), 790-795.
- De Cicco, L., Mascolo, S., & Palmisano, V. (2011). Skype Video congestion control: An experimental investigation. *Computer Networks*, 55(3), 558-571.
- Exarchakos, G., Menkovski, V., & Liotta, A. (2011). Can Skype be used beyond video calling?. In *Proceedings of the 9th International Conference on Advances in Mobile Computing and Multimedia* (pp. 155-161). ACM.
- Goudarzi, M., Sun, L., & Ifeachor, E. (2011). Modelling Speech Quality for NB and WB SILK Codec for VoIP Applications. In *Next Generation Mobile Applications, Services and Technologies (NGMAST), 2011 5th International Conference on* (pp. 42-47). IEEE.
- Huang, T. Y., Huang, P., Chen, K. T., & Wang, P. J. (2010). Could Skype be more satisfying? a QoE-centric study of the FEC mechanism in an internet-scale VoIP system. *Network, IEEE*, 24(2), 42-48.
- ITU. (2013), P.50: Artificial voices – ITU. <http://www.itu.int/rec/T-REC-P.50> (Accessed 26/02/2013)
- Liotta, A., Druda, L., Menkovski, V., & Exarchakos, G. (2012). Quality of experience management for video streams: the case of Skype. In *Proceedings of the 10th International Conference on Advances in Mobile Computing & Multimedia* (pp. 84-92). ACM.
- ManyCam. (2013), ManyCam free virtual webcam effects software. <http://www.manycam.com/> (Accessed 26/02/2013)
- NEWT. (2013), Network Emulator for Windows Toolkit – NEWT. <http://social.microsoft.com/Forums/en/msmnetworking/thread/59bec8ca-fbd6-4ce7-8365-249a7646ef97> (Accessed 26/02/2013)
- Sat, B., & Wah, B. W. (2007). Evaluation of conversational voice communication quality of the Skype, Google-Talk, Windows Live, and Yahoo Messenger VoIP systems. In *Multimedia Signal Processing, 2007. MMSP 2007. IEEE 9th Workshop on* (pp. 135-138). IEEE.
- Skype. (2013), Free Skype internet calls and cheap calls to phones online - Skype. <http://www.skype.com/en/> (Accessed 26/02/2013)
- Virtual Audio Cable. (2013), Virtual Audio Cable Home Page. <http://software.muzychenko.net/eng/vac.htm> (Accessed 26/02/2013)
- Xu, Y., Yu, C., Li, J., & Liu, Y. (2012). Video telephony for end-consumers: Measurement study of Google+, iChat, and Skype. In *Proceedings of the 2012 ACM conference on Internet measurement conference* (pp. 371-384). ACM.
- Zhang, X., Xu, Y., Hu, H., Liu, Y., Guo, Z., & Wang, Y. (2012). Profiling Skype video calls: Rate control and video quality. In *INFOCOM, 2012 Proceedings IEEE* (pp. 621-629). IEEE.
- Zhu, J. (2011). On traffic characteristics and user experience of Skype video call. In *Quality of Service (IWQoS), 2011 IEEE 19th International Workshop on* (pp. 1-3). IEEE.

Appendix 2

2015 Eight International Workshop on Selected Topics in Mobile and Wireless Computing

A QoE-DRIVEN VERTICAL HANDOVER ALGORITHM BASED ON MEDIA INDEPENDENT HANDOVER FRAMEWORK

Li Liu, Lingfen Sun, Emmanuel Ifeakor
School of Computing, Electronic and Mathematics
Plymouth University
Plymouth, PL4 8AA, UK
{li.liu; L.Sun; E.Ifeakor}@plymouth.ac.uk

Abstract—The current mobile network has been developed to a heterogeneous network that is coexistence of different wireless networks such as UMTS (3G), WIFI, WIMAX (4G) and LTE (4G). Since the demand of real-time multimedia services has significantly increased in recent years and Quality of Experience (QoE) becomes more and more important to users, any single wireless network is hardly to maintain good QoE of multimedia service at any time and in anywhere for any users. Hence, in order to achieve the goal, it is necessary to converge different wireless networks to take the advantages of different wireless networks. However, even though IEEE 802.21-Media Independent Handover (MIH) provides a framework for supporting seamless vertical handover (VHO), how to select an appropriate network and when to carry out handover are still the key challenges to maintain QoE of multimedia service. This paper addresses a QoE-driven VHO algorithm based on MIH that aims to maintain multimedia service with acceptable QoE and avoid unnecessary handover in the heterogeneous network. The performance evaluation was carried out to compare with default MIH bandwidth-based VHO algorithm on video service over UMTS and WIFI networks in Network Simulator 2 (NS2). The results showed that the QoE-driven VHO algorithm could maintain better QoE of multimedia service than the bandwidth-based VHO algorithm by considering video content, and initiated VHO immediately when the QoE of multimedia service became unacceptable. Furthermore, Block List (BL) and acceptable QoE policy could avoid unnecessary handover effectively.

Keywords—heterogeneous network, vertical handover, MIH, QoE

I. INTRODUCTION

In recent years, the wireless network has evolved into a heterogeneous network that is coexistence of different wireless networks such as UMTS (3G), WIFI, WIMAX and LTE (4G). Due to rapidly increasing demand for multimedia services in mobile network, mobility management becomes an important issue. How to maintain Quality of

Experience (QoE) for multimedia services during handover between different networks remains a challenge. Existing work on handover algorithms have focused mainly on network Quality of Service (QoS), e.g. always connecting to the network with the largest bandwidth or smallest delay during handover for a delivered multimedia service. This QoS-based approach may not be optimised to provide a better QoE or an acceptable QoE for an end user (e.g. when watching a video or making a video call using a mobile in the move). In order to provide good QoE of multimedia services for users, the advantages and characteristics of different networks could be converged to create a more powerful and larger heterogeneous wireless network which allows a mobile device to select a better network and handover the connection between different networks without affecting the quality of multimedia service. Therefore, vertical mobility management system needs to be developed and seamless vertical handover (VHO) is the key to provide excellent service in a heterogeneous network [2]. The IEEE group proposed the IEEE standard 802.21 – Media Independent Handover (MIH) framework which is designed to support seamless VHO between different wireless networks [3-5]. However, MIH only provides a general framework, how to select appropriate network and carry out handover at suitable time are undefined and this has left many open questions. Furthermore, how to bring in QoE in the handover decision cycle has not been taken into consideration fully. In recent years, most of VHO algorithms are focused on network QoS parameters. Some initial work on QoE-based handover algorithm have been proposed [21-23]. Nevertheless, the work are limited on long time training process and without considering on video content. This paper will introduce a QoE-driven VHO algorithm based on

MIH. This algorithm would only decide to initiate handover when QoE of multimedia service becomes unacceptable instead of always connecting to network that could provide a better QoE. Furthermore, QoE-driven VHO algorithm is content-based which means it could measure QoE of video service depending on the contents movement of the video.

The rest of the paper is organised as follows: Section II will describe the background of mobility management and the IEEE 802.21MIH framework. Then, the related work will be introduced in Section III. The proposed QoE-driven VHO algorithm and its performance evaluation will be discussed in Sections IV and V, respectively. Finally, conclusion and future work will be presented in Section VI.

II. BACKGROUND

A. Mobility Management

Mobility management includes mobility protocols and handover management [6]. Many Internet protocols support mobility management, such as Mobile IPv4 (MIPv4) and Mobile IPv6 (MIPv6). There are two types of handover: horizontal handover and vertical handover (VHO). Horizontal handover refers to the mobile node (MN) handover between two network base stations (BSs) with same wireless technologies. In contrary, VHO happens between two BSs with different wireless technologies. There are three phrases in handover process: Information Gathering Phase, Network Selection Phase and Handover Execution Phase [7].

- Information Gathering Phase: mobility management systems would not only collect information relating to networks such as network type and bandwidth, but also collect the capabilities of mobile devices and user preferences, e.g. speed and preferred network.
- Network Selection Phase: depending on the collected information and VHO algorithm, mobility management system will make the decision to stay in the current network or select an appropriate network to initiate a handover.
- Handover Execution Phase: once a targeted network has been selected, mobility management system will execute handover based on mobility protocols.

B. Media Independent Handover Framework

In order to achieve seamless VHO between different wireless networks, MIH function (MIHF) will be implemented in MN and network node to achieve the following three services: Media Independent Event Service (MIES), Media Independent Command Service (MICS) and Media Independent Information Service (MIIS) [1, 3, 4]. The MIH services are used to communicate with upper layers (layer three and above) and lower layers (layer two and below). The commands and information flows are depicted as Figure 1.

MIES is responsible to detect the changes in lower layers, such as link status and link quality, generate event reports based on the type of changes, and then send to upper layers. MICS provides the commands for upper layers to control lower layers based on the handover decision. MIIS is used to collect the essential information from both upper and lower layers for handover decision. The collected information may include static link layer parameters (e.g. network type and bandwidth) and dynamic network layer parameters (e.g. packet loss rate). Furthermore, the local entity and remote entity also could communicate and exchange information with each other through MIHF.

C. Vertical Handover Algorithm

VHO algorithm is a process for MIHF to make vertical handover decision and select a target network from candidate networks. VHO algorithms may choose different criteria for handover decision making, such as network type, bandwidth, packet loss rate, cost or a combination of these parameters. Particular criteria may decide when to initiate a handover and which candidate network to handover

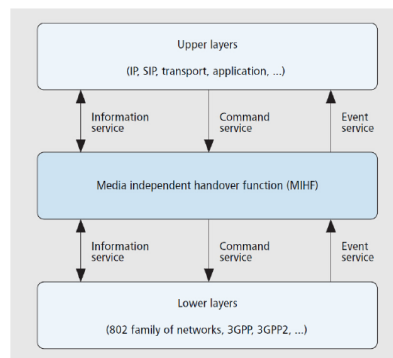

Figure 1: MIH services [1]

to. Depending on specific criteria, VHO algorithms can be classified into four types: Received Signal Strength (RSS)-based, bandwidth-based, cost function-based and combination VHO algorithms [8-10].

III. RELATE WORK

In recent years, many research efforts have been put in developing efficient and effective VHO algorithms. In the studies of Zahran and Xiaohuan, RSS-based VHO algorithms were proposed to minimize the probability of handover failure [11, 12]. However, RSS-based VHO algorithms would suffer from large handover delay and may waste network resources. Yang et al. [13] and Chi et al. [14] investigated bandwidth-based VHO algorithms which could increase overall throughput, but it is difficult to measure available bandwidth due to dynamic nature of network. Moreover, bandwidth-based VHO algorithms would also increase unnecessary handover times. Cost function-based VHO algorithms, proposed by Hasswa, Tawil and Fang et al. [15-17] could increase throughput and reduce the handover delay. However, it is difficult to estimate the specific parameters (e.g. available bandwidth) from other candidate networks. Considering that one single parameter is insufficient for a VHO algorithm to make an appropriate decision, combination VHO algorithms were developed to resolve this issue. In the researches of Liu, Nasser and Pahlavan et al. [18-20], combination VHO algorithms have been demonstrated to reduce the ping-pong effects and the number of handovers. However, due to the training delay, the handover latency would be significantly rising. All of the above VHO algorithms just considered the network Quality of Service (QoS) parameters that are not directly linked with user perceived quality, or Quality of Experience (QoE). Pimrat et al. and Ros et al. [21-23] proposed QoE-based VHO algorithms which used pseudo-subjective quality assessment (PSQA) method to measure QoE perceived by users. Their method ignored the video content that will affect QoE significantly. In their results, the details of handover and network selection were missing. Furthermore, since MN will be always

connected to the network with the highest score, most MNs may handover to same network that may cause the congestion of the targeted network and ping-pong effects. Additionally, if handover decisions were made on network servers (e.g. wireless routers), the burden and capability requirements of the network servers would be extremely high when the number of users is significantly increased.

This paper will introduce a QoE-driven VHO algorithm which could maintain an acceptable QoE of different type of video for mobile users, and at the same time, avoid unnecessary handover (e.g. ping-pong effects) to save device energy and network resources. Furthermore, the QoE-driven VHO algorithm is implemented in MNs so that the burden of network server could be dramatically decreased.

IV. QOE-DRIVEN VHO ALGORITHM

A. Video QoE prediction model

In the QoE-driven VHO algorithm, a reference-free video QoE prediction model is applied [24]. This model can predict QoE of a video service delivered over a wireless network based on a combination of network and application related parameters, including Packet Error Rate (PER), Sender Bitrate (SBR) and Frame Rate (FR). The QoE prediction equation (in terms of Mean Opinion Score, MOS) is shown in (1). Furthermore, this QoE prediction model also defines three types of video content depending on motion, namely, Slight Movement (SM), Gentle Walking (GW) and Rapid Movement (RM). The coefficient metrics were obtained by nonlinear regression analysis and shown in Table 1 [24].

$$MOS = \frac{a_1 + a_2FR + a_3 \ln(SBR)}{1 + a_4PER + a_5(PER)^2} \quad (1)$$

B. QoE-driven VHO algorithm

The proposed QoE-driven VHO algorithm aims to maintain an acceptable QoE of video services for users and avoid unnecessary handover. Based on telecommunication services quality requirement, an acceptable QoE normally means a MOS higher than 3.5 for a delivered service. When the MOS is less than 3.5, video quality would become unacceptable to users. Since the wireless network condition is dynamic, if MNs always search for and connect to the network with the best QoE, many unnecessary handover between two networks with good QoE would occur. Additionally, most MNs would handover to a good network easily and the network would become congested quickly. Then MNs have

Table 1: Coefficient metrics of all types of video

Coeff	SM	GW	RM
a1	2.797	2.273	-0.0228
a2	-0.0065	-0.0022	-0.0065
a3	0.2498	0.3322	0.6582
a4	2.2073	2.4984	10.0437
a5	7.1773	-3.7433	0.6865

to search for another better network again and cause the so-called Ping-Pong effects. Hence it is necessary to set the acceptable QoE as handover threshold that a multimedia service with acceptable QoE could be maintained and unnecessary handover could be avoided. Furthermore Block List (BL) and Minimal Connecting Time (MCT) are applied in the QoE-driven VHO algorithm. BL is used to store the list of networks that are unable to provide acceptable QoE. QoE-driven VHO algorithm would automatically ignore the network listed in the BL to avoid the unnecessary handover. MCT is designed for the target network and defined as different values depending on the types of networks. After MNs handover to a targeted network, MNs have to connect the targeted network in defined period of time. During this period of time, the QoE-driven VHO algorithm will ignore all candidate networks, because the QoE-driven VHO algorithm needs a short period of time (e.g. about 3 seconds) to receive enough data to measure QoE of video service in new network. Furthermore, the QoE-driven VHO algorithm integrates with MIH and is implemented in MN that the burden of network server will be significantly released.

QoE-driven VHO algorithm is integrated with MIH. In the MIH framework, network server, e.g. WIFI Access Point (AP) and WIMAX Base Station (BS), will distribute Radio Advertisements (RA) regularly to inform MNs the availability of network. Thus QoE-driven VHO algorithm will only be activated when MN receives RA from network server instead of being activated all the time, because if there is no available network, there is no need to consider handover. In this case the power and processor memory of MNs could be saved. The processes flow of QoE-driven VHO algorithm is shown in Figure 2.

As shown in Figure 2, when MN receives a RA from a candidate network, QoE-driven VHO algorithm will be activated. First of all, QoE-driven VHO algorithm will check whether the candidate network has been recorded in BL. If the candidate network has been recorded in BL, QoE-driven VHO algorithm would ignore this candidate network. Otherwise, the type and connecting time of current network will be identified for next MCT checking. Then, if the current connecting time were shorter than MCT, QoE-driven VHO algorithm would ignore this candidate network. If the current connecting time were longer than MCT, QoE-driven VHO algorithm would move forward to check the QoE of multimedia service. Only if the current QoE is unacceptable (MOS less than 3.5), QoE-driven VHO algorithm

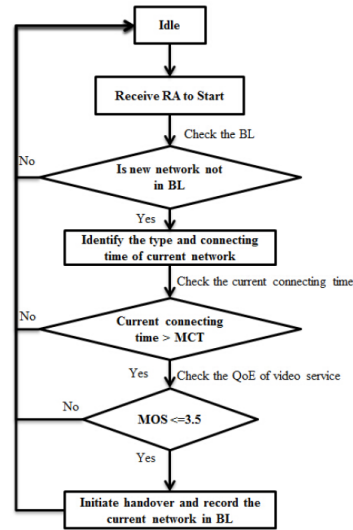

Figure 2: QoE-driven VHO algorithm flow

network will initiate handover to this candidate network and record current connecting network in BL. When current QoE is acceptable, QoE-driven VHO algorithm will ignore this candidate network. By applied acceptable QoE, BL and MCT, QoE-driven VHO algorithm is supposed to maintain the acceptable QoE of multimedia service and avoid unnecessary handover. The performance evaluation of QoE-driven VHO algorithm over UMTS and WIFI networks will be presented in next section.

V. PERFORMANCE EVALUATION

A. Simulation Design and Topology

Network Simulator 2.29 (NS 2.29) is used to simulate multimedia service over heterogeneous network. NS 2.29 is integrated with MIH framework to support seamless VHO between UMTS network, WIFI network and WIMAX network. In this simulation, the performance of proposed QoE-driven VHO algorithm will be evaluated over UMTS network and WIFI network. Furthermore, the comparison between QoE-driven VHO algorithm and default MIH bandwidth-based VHO algorithm will be carried out over UMTS network and WIFI network. In order to evaluate the performance of QoE-driven VHO algorithm, three wireless networks, including one UMTS network and two WIFI

networks, will be implemented in the simulation. Two WIFI networks will be located in the coverage of the UMTS network. There are one RNC (Radio Network Controller) and one UMTS BS to provide UMTS network. In each WIFI network, there is a WIFI AP to provide WIFI network. A UMTS interface and a WIFI interface are implemented a MN as multi-interface MN. Hence the MN is able to connect to UMTS network and WIFI network. A video server is used to provide video service for the MN. In order to evaluate that whether QoE-driven VHO algorithm could maintain acceptable QoE of different types of video, SM reference video – Akyio and RM reference video – Football are used to generate two types of sending video. Each sending video will last 120 seconds. A router is implemented in this simulation to connect between three networks and video server. The topology of simulation is depicted in Figure 3.

The process of this simulation is designed as that the multi-interface MN will connect to UMTS network at beginning of the simulation. Firstly, the multi-interface MN will go through the coverages of WIFI_1 network. Then the multi-interface will leave the coverage of WIFI_1 network and move forward to WIFI_2 network. UMTS network is defined as background network that will not be recorded in BL. This simulation will last 180 seconds and the video server will start to send the video to multi-interface MN at the 20th second. In order to test QoE-driven VHO algorithm how to cope with minor PER and react to the change of network condition, the condition of three networks are defined as following: For WIFI_1 network, the PER of WIFI_1 network is set to 1% at starting of the simulation. Then, the PER of WIFI_1 network will be reset to 10% at 60th seconds. The PER of UMTS network will be 0% and

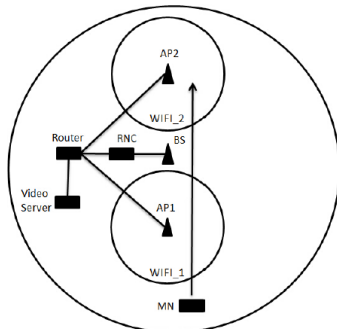

Figure 3: Simulation Topology

the PER of WIFI_2 network will be set to 1% from the beginning to end of the simulation. When the simulation starts, the MN will connect to UMTS network as the background network. When the MN moves into a WIFI network, the MN will connect to the WIFI network automatically. The MN will move into the coverage of WIFI_1 network at around the 38th second and leave around the 100th second. During those times, the network condition will become worse to test QoE-driven VHO algorithm and bandwidth-based VHO algorithm. Then, at about the 115th second, the MN will enter the coverage of WIFI_2 network and stay in the coverage of WIFI_2 network until the end of simulation. In this simulation, the default MIH bandwidth-based VHO algorithm will be used to compare with the QoE-driven VHO algorithm. The QoS performance and QoE performance will be carried out in terms of QoS parameters and MOS. The network parameters and video parameters are illustrated in Table 2.

B. Results and Analysis

In this section, the QoS and QoE performance of QoE-driven and bandwidth-based VHO algorithms will be presented and analysed based on the results of simulation.

As shown in Figure 4, when SM video was sending from video server to the multi-interface MN, QoS performance of QoE-driven VHO algorithm were better than bandwidth-based VHO algorithm. It is clear that QoE-driven VHO algorithm kept lower average PER for SM video service than bandwidth-based VHO algorithm. When the MN switched connection over WIFI_1 network, the average PER slightly increased. At this moment, even there was minor PER in WIFI_1 network, QoE-driven VHO algorithm still decided to keep connecting to WIFI_1 instead of handover to UMTS, because the QoE of SM video still was acceptable under minor PER. When the PER dramatically augmented after 60th

Table 2: Simulation Parameters

Parameters	Wireless Technology		
	UMTS	WIFI_1	WIFI_2
Coverage Area	500 m	50 m	50 m
Bandwidth	384 kbps	11 Mbps	11 Mbps
Packet Error Rate	0%	1% and 10%	1%
Parameters	Multi-interface MN		
Speed	2 m/s		
Parameters	SM Video	RM Video	
Video Frames	3000	3000	
Frame Rate	25	25	
Sender Bitrate	240 kbps	640 kbps	

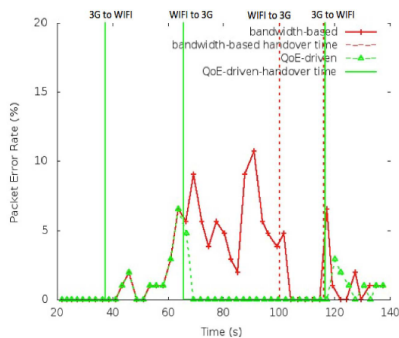

Figure 4: Average PER of SM video

second, QoE-driven VHO algorithm made the handover decision to switch video stream to UMTS network immediately. Hence QoE-driven VHO algorithm successfully avoided the dramatic PER. However, while the average PER reached about 10%, bandwidth-based VHO algorithm still decided to connect to WIFI_1 network rather than handover to UMTS. Through checking the reconstructed video, the QoE of video became bad and unacceptable to users, when PER increased to about 8%. When the MN entered the coverage area of WIFI_2 network, both of QoE-driven VHO algorithm and bandwidth-based VHO algorithm switched video stream to WIFI_2 network and stayed in WIFI_2 network.

The average PER of RM video is shown as Figure 5. Compared to Figure 4, bandwidth-based VHO algorithm still decided to stay in WIFI_1 network, when PER was dramatic increasing. However, since RM video was more sensitive to PER than SM video, QoE-driven VHO algorithm switched the video stream connection to UMTS network before PER began rising significantly. Furthermore, since WIFI_1 was recorded in BL, even though the MN still was in the coverage area of WIFI_1 network and kept receiving the RA from WIFI_1 network, QoE-driven VHO algorithm just ignored WIFI_1 network and kept connecting to UMTS network. After the MN left the coverage of WIFI_1 network and moved into WIFI_2 network, the multi-interface MN connected to WIFI_2 network firstly. Nevertheless, unlike SM VIDEO, QoE of SM VIDEO became unacceptable over WIFI_2 network. Thus QoE-driven VHO algorithm decided to handover to UMTS quickly once QoE-driven VHO algorithm detected the current QoE of RM video was unacceptable to users. However, bandwidth-based VHO algorithm treated RM video as same as SM video that still

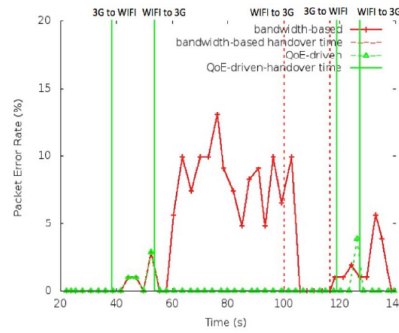

Figure 5: Packet error rate of RM video

decided to keep the connection of RM video on WIFI_2 network. It is obvious that QoE-driven VHO algorithm made better VHO decision than bandwidth-based VHO algorithm to react to the change of network condition. Moreover, QoE-driven also considered the video content to make handover decision.

The QoE performances of SM video and RM video with QoE-driven VHO algorithm and bandwidth-based VHO algorithm are shown as Figure 6 and Figure 7. As shown in Figure 6, the MN connected to WIFI_1 network around 38 seconds and the QoE of video service started decreasing slightly. As in this case, even though there was minor PER in WIFI_1 network, but the MOS was still more than 3.5 that meant quality of SM video was acceptable to users. Hence QoE-driven VHO algorithm decided to keep connecting to WIFI_1 network. The bandwidth-based VHO algorithm also decided to keep the connection with WIFI_1 network. Then, after 60th second, the network condition became worse and the

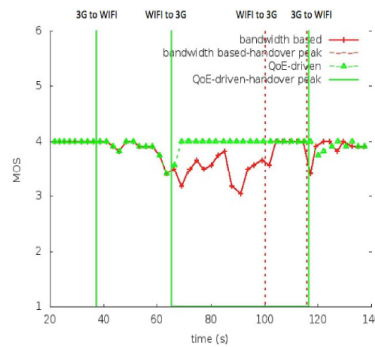

Figure 6: QoE performance of SM video

MOS of SM video dramatically decreased. Once the MOS became less than 3.5, the QoE-driven VHO algorithm decided to switch the video stream connection to UMTS network. Additionally, by checking BL, WIFI_1 network was ignored by QoE-driven VHO algorithm even WIFI_1 still was available. There was no need to connect to WIFI_1 network again, because the network condition still would not be good enough to provide video service with acceptable QoE. Then QoE-driven VHO algorithm would have to handover the video stream back to UMTS network again. Those unnecessary handover would consume extra power of MNs and cause extra burden on network providers. However, when the network condition of WIFI_1 network turned bad, bandwidth-based VHO algorithm still decided to keep connecting to WIFI_1 network until leaving the coverage area of WIFI_1 network, even the quality of video service decreased and became unacceptable to users. When the MN entered the coverage of WIFI_2 network, the MN connected to WIFI_2 network automatically. Even though there were minor packet errors in WIFI_2 network, the MOS of SM video still was above 3.5 that meant the QoE of SM video was acceptable to users. Hence both of QoE-driven VHO algorithm and bandwidth-based VHO algorithm decided to keep connecting to WIFI_2 network until the end of simulation.

As shown in Figure 7, since RM video was more sensitive to packet errors than SM video, the QoE of RM video had become unacceptable before the network condition of WIFI_1 network turned worse at the 60th second. Hence QoE-driven VHO algorithm made the decision to handover to UMTS network immediately once MOS of RM video became less than 3.5. However, even the MOS of RM video was nearly reduced to 2 after 60th second,

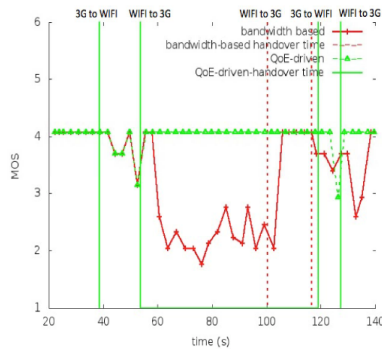

Figure 7: QoE performance of RM video

bandwidth-based VHO algorithm still kept connecting to WIFI_1 network until the MN left the coverage of WIFI_1 network. As in this case, the QoE of RM video became bad and unacceptable to users. The users would be disappointed with this quality of RM video. When the MN moved into the coverage of WIFI_2 network, QoE-driven VHO algorithm also quickly made handover decision to switch RM video stream to UMTS network and maintain the acceptable QoE for users, once the MOS became less than 3.5. Bandwidth-based VHO algorithm still decided to keep connecting to WIFI_2 network until the end of this simulation. It is clear that QoE-driven VHO algorithm is able to maintain acceptable QoE for users when the network condition becomes worse. Furthermore, QoE-driven VHO algorithm makes handover decision based on MOS that could reflect the QoE of video service regardless of the types of video. However, bandwidth-based VHO algorithm is unable to maintain acceptable QoE for users when network gets worse. Moreover, since bandwidth-based made handover decision only based on the bandwidth of network without considering video content, it just treated RM video as same as SM video.

In order to find out the overall QoE performance of SM and RM video, the average MOSs of overall SM and RM video service are shown in Table 3. It is obvious that QoE-driven VHO algorithm can provide better QoE than bandwidth-based VHO algorithm. Even though RM video was much easier to be affected by packet errors and more difficult to sustain QoE than SM video, QoE-driven VHO algorithm could maintain QoE of RM video efficiently and make handover decision quickly based on MOS. Furthermore, for SM video, both of QoE-driven VHO algorithm and bandwidth-based VHO algorithm could maintain the acceptable overall QoE performance. However, only QoE-driven VHO algorithm could maintain acceptable overall QoE performance for RM video. Bandwidth-based VHO algorithm was unable to maintain acceptable QoE performance for RM video. Hence it is necessary to consider video content into handover decision. QoE-driven VHO algorithm is suitable for maintaining acceptable QoE for video service no matter SM video or RM video.

Table 3: Average MOS of overall SM and RM Video

	SM	RM
QoE-driven VHO Algorithm	3.95	4.01
Bandwidth-based VHO Algorithm	3.80	3.30

VI. CONCLUSION AND FUTURE WORK

This paper proposed a QoE-driven VHO algorithm that it makes handover decision based on MOS. The QoE-driven VHO algorithm is focused on maintaining an acceptable QoE of multimedia service at the same time avoiding unnecessary handover. Video content also is considered in QoE-driven VHO algorithm to make handover decision accurately and quickly. The performance evaluation of QoE-driven VHO algorithm was carried out in NS 2.29. The results showed QoE-driven effectively maintained acceptable QoE for both of SM video and RM video. Compared with bandwidth-based VHO algorithm, QoE-driven VHO algorithm could quickly make better handover decision when the network condition became worse. Furthermore, QoE-driven VHO algorithm could provide better QoE of video service than bandwidth-based VHO algorithm.

In next stage, performance of QoE driven VHO algorithm over UMTS, WIFI and WIMAX networks will be evaluated. Then subjective tests will be carried out to evaluate the QoE performance properly. Moreover, multi-users and multi-networks will be applied in the simulation to test the performance of network utilization and balance. Video adaptation will be considered to integrate with QoE-driven VHO algorithm.

REFERENCES

- [1] G. Lampropoulos, A. K. Salkintzis, and N. Passas, "Media-independent handover for seamless service provision in heterogeneous networks," *Communications Magazine, IEEE*, vol. 46, pp. 64-71, 2008.
- [2] S. Fernandes and A. Kamouch, "Vertical Mobility Management Architectures in Wireless Networks: A Comprehensive Survey and Future Directions," *Ieee Communications Surveys and Tutorials*, vol. 14, pp. 45-63, 2012.
- [3] O. Khattab and O. Alani, "Survey on Media Independent Handover (MIH) Approaches in Heterogeneous Wireless Networks," in *Wireless Conference (EW), Proceedings of the 2013 19th European*, 2013, pp. 1-5.
- [4] A. De La Oliva, A. Banchs, I. Soto, T. Melia, and A. Vidal, "An overview of IEEE 802.21: media-independent handover services," *Wireless Communications, IEEE*, vol. 15, pp. 96-103, 2008.
- [5] K. Taniuchi, Y. Ohba, V. Fajardo, S. Das, M. Tatui, Y.-H. Cheng, et al., "IEEE 802.21: Media independent handover: Features, applicability, and realization," *Communications Magazine, IEEE*, vol. 47, pp. 112-120, 2009.
- [6] I. Al-Summi, M. Othman, and B. M. Ali, "Mobility management for IP-based next generation mobile networks: Review, challenge and perspective," *Journal of Network and Computer Applications*, vol. 35, pp. 295-315, Jan 2012.
- [7] B. R. Chandavarkar and G. R. M. Reddy, "Survey Paper: Mobility Management in Heterogeneous Wireless Networks," *Procedia Engineering*, vol. 30, pp. 113-123, 2012.
- [8] J. Marquez-Barja, C. T. Calafate, J. C. Cano, and P. Manzoni, "An overview of vertical handover techniques: Algorithms, protocols and tools," *Computer Communications*, vol. 34, pp. 985-997, Jun 2011.
- [9] X. Yan, Y. Ahmet Şekerçioğlu, and S. Narayanan, "A survey of vertical handover decision algorithms in Fourth Generation heterogeneous wireless networks," *Computer Networks*, vol. 54, pp. 1848-1863, 2010.
- [10] M. Kassar, B. Kervella, and G. Pujolle, "An overview of vertical handover decision strategies in heterogeneous wireless networks," *Computer Communications*, vol. 31, pp. 2607-2620, 2008.
- [11] A. H. Zahran, B. Liang, and A. Saleh, "Signal threshold adaptation for vertical handoff in heterogeneous wireless networks," *Mob. New. Appl.*, vol. 11, pp. 625-640, 2006.
- [12] Y. Xiaohuan, N. Mani, and Y. A. Sekercioglu, "A Traveling Distance Prediction Based Method to Minimize Unnecessary Handovers from Cellular Networks to WLANs," *Communications Letters, IEEE*, vol. 12, pp. 14-16, 2008.
- [13] Y. Kemeng, I. Gondal, Q. Bin, and L. S. Dooley, "Combined SINR Based Vertical Handoff Algorithm for Next Generation Heterogeneous Wireless Networks," in *Global Telecommunications Conference, 2007. GLOBECOM '07. IEEE*, 2007, pp. 4483-4487.
- [14] C. Chi, X. Cai, R. Hao, and F. Liu, "Modeling and Analysis of Handover Algorithms," in *Global Telecommunications Conference, 2007. GLOBECOM '07. IEEE*, 2007, pp. 4473-4477.
- [15] A. Hasswa, N. Nasser, and H. Hassanein, "Tramcar: A Context-Aware Cross-Layer Architecture for Next Generation Heterogeneous Wireless Networks," in *Communications, 2006. ICC '06. IEEE International Conference on*, 2006, pp. 240-245.
- [16] R. Tawil, G. Pujolle, and O. Salazar, "A Vertical Handoff Decision Scheme in Heterogeneous Wireless Systems," in *Vehicular Technology Conference, 2008. VTC Spring 2008. IEEE*, 2008, pp. 2626-2630.
- [17] Z. Fang and J. McNair, "Optimizations for vertical handoff decision algorithms," in *Wireless Communications and Networking Conference, 2004. WCNC. 2004 IEEE*, 2004, pp. 867-872 Vol.2.
- [18] X. Liu, J. Ling-ge, and H. Chen, "A Novel Fuzzy Logic Vertical Handoff Algorithm with Aid of Differential Prediction and Pre-Decision Method," in *Communications, 2007. ICC '07. IEEE International Conference on*, 2007, pp. 5665-5670.
- [19] N. Nasser, S. Guizani, and E. Al-Masri, "Middleware Vertical Handoff Manager: A Neural Network-Based Solution," in *Communications, 2007. ICC '07. IEEE International Conference on*, 2007, pp. 5671-5676.
- [20] K. Pahlavan, P. Krishnamurthy, A. Hatami, M. Ylianttila, J. Makela, R. Pichna, et al., "Handoff in hybrid mobile data networks," *Personal Communications, IEEE*, vol. 7, pp. 34-47, 2000.
- [21] K. Piamrat, A. Ksentini, C. Viho, and J. Bonnin, "QoE-aware vertical handover in wireless heterogeneous networks," in *Wireless Communications and Mobile Computing Conference (IWCMC), 2011 7th International*, 2011, pp. 95-100.
- [22] K. Piamrat, A. Ksentini, C. Viho, and J. Bonnin, "QoE-based network selection for multimedia users in IEEE 802.11 wireless networks," in *Local Computer Networks, 2008. LCN 2008. 33rd IEEE Conference on*, 2008, pp. 388-394.
- [23] D. Ros, rio, E. Cerqueira, A. Neto, A. Riker, R. Immich, et al., "A QoE handover architecture for converged heterogeneous wireless networks," *Wirel. Netw.*, vol. 19, pp. 2005-2020, 2013.
- [24] A. Khan, L. Sun, E. Jammeh, and E. Ifeakor, "Quality of experience-driven adaptation scheme for video applications over wireless networks," *IET Communications* 4(11), 1337-1347.

Appendix 3

2016 IEEE 12th International Conference on Wireless and Mobile Computing, Networking and Communications (WiMob)

User-centric QoE-driven Vertical Handover Framework in Heterogeneous Wireless Networks

Li Liu, Lingfen Sun, Emmanuel Ifeachor
School of Computing, Electronics and Mathematics
Plymouth University
Plymouth, PL4 8AA, UK
{li.liu; L.Sun; E.Ifeachor}@plymouth.ac.uk

Abstract— With advances in wireless technology and the increase in popularity of mobile devices, more and more people now rely on mobile devices for multimedia services (such as video streaming and video calls). A mobile device can be connected and roamed to different networks in heterogeneous wireless networks. The Media Independent Handover (MIH) framework is designed by the IEEE 802.21 group to support seamless vertical handover between different networks. However, how to select an appropriate network from available ones and when to execute the handover remain the key challenges in MIH. This paper proposes a user-centric QoE-driven vertical handover (VHO) framework, based on MIH, which aims to maintain acceptable QoE of different mobile application services and to select an appropriate network based on users' preferences (e.g. on cost). Further a user-centric QoE-driven algorithm is implemented in the proposed framework. Its performance is evaluated and compared with two other VHO algorithms based on Network Simulator 2 (NS2) for video streaming services over heterogeneous networks. The preliminary results show that the proposed algorithm can maintain better QoE and at the same time, take into account user's preference on cost when compared with the other two algorithms.

Keywords: *Heterogeneous networks, QoE, vertical handover, user-centric, MIH.*

I. INTRODUCTION

In recent years, with the development of mobile devices and wireless technology, most mobile devices are able to connect to different wireless networks such as UMTS (3G), WiFi, WiMAX (4G) and LTE (4G). Users use different applications on smart phones anywhere, anytime, and over any networks. The number of people using applications on smart mobile phones is also increasing significantly. According to Cisco Visual Networking Index (VNI) forecast, WiFi and mobile devices will account for about 66% of IP traffic, and 82% of all consumer Internet traffic will be video by 2020 [1]. With the increase in mobile video data, it is vital for service providers to provide satisfactory Quality of Experience (QoE) for end users for mobile video service delivery (such as video streaming, e.g. YouTube, and video gaming). From both customer and service providers' perspectives, cost is also a major concern in service provisioning. However, no single wireless technology can

fulfill the requirements of quality and cost at the same time. Hence, it is necessary to take advantage of different wireless technologies to provide satisfactory QoE, and at the same time, maintain reasonable cost for mobile data usage for customers. In order to utilize different wireless technologies, mobile services should be handed over between different wireless technologies to achieve seamless vertical handover without affecting the users' experience of a service.

The IEEE 802.21 group designs a Media Independent Handover (MIH) framework to support seamless vertical handover between different networks [2, 3]. However, how to select an appropriate network from available networks and when to execute a vertical handover still remain open questions and represent a key challenge in MIH [4-6]. Most existing research on VHO algorithms are focused on Quality of Service (QoS) issues, such as network parameters (e.g. bandwidth and packet loss). Only few proposed VHO algorithms which consider the QoE of multimedia services aimed at achieving the highest QoE all the time [7-9]. Due to limited network resources, we consider that it is difficult to achieve the highest QoE all the time which might cause unnecessary handover and incur high cost for users. Further each user might have different considerations on cost and mobile bill. Thus, both QoE and user preferences (e.g. cost) should be taken into account when designing a VHO algorithm. Additionally, different types of video also should be considered due to its different impact on QoE. This paper proposes a user-centric QoE-driven vertical handover (VHO) framework based on the MIH framework. It aims to maintain an acceptable QoE for different application services for users and to select an appropriate network based on users' budget and preference. A user-centric QoE-driven VHO algorithm is also implemented and the performance is evaluated and compared with QoS-based VHO algorithms with three different types of videos on NS2.

The rest of the paper is structured as follows: the background to vertical handover and the MIH framework is introduced in Section II. In Section III, related work is reviewed. Then, a user-centric QoE-driven VHO framework and algorithm are described in Section IV. Performance evaluation and results analysis are presented in Section V. Finally, the conclusion and future work are summarized in Section VI.

II. BACKGROUND

A. Handover Management

Most recent smart phones have multi-interfaces that allow users to connect to multi-networks such as UMTS (3G) and WiFi. Handover management is a key component of mobility management to support data roaming from one network to another [5]. In handover management concept, there are many features such as mobility scenarios and handover types, as illustrated in Fig. 1. Depending on the mobility scenario, there are two kinds of handover: horizontal handover and vertical handover. Horizontal handover means that the handover takes place between two access points with the same wireless technology. If the two access points have different wireless technology, the handover is called vertical handover. However, the handover also may be classified in a different way based on other features such as handover control and handover type. The process of handover management includes three phases as following:

- **Handover Information Gathering:** to collect all required information from available networks for supporting handover decision phase.
- **Handover Decision:** to analyze all collected information, to select target network from available networks and to decide when to execute a handover depending on a handover algorithm.
- **Handover Execution:** to connect to the selected network based on the handover decision and to switch connection to targeted network.

Among the above three phases, the handover decision phase is the key of handover management process. An appropriate handover decision could improve the QoS and provide users a decent QoE. Otherwise, users would have a poor quality of experience for the provided service. The handover decision is made by a handover algorithm (also called handover strategies). There are many different handover algorithms based on different decision criteria such as Radio Signal Strength (RSS), user preference and QoS

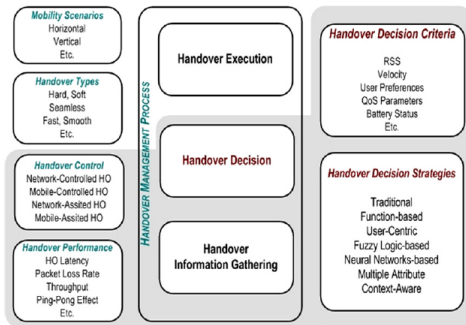

Figure 2: Handover Management Concept [5]

parameters. For example, a user-centric VHO algorithm will consider users' requirement into handover decision based on users' preferences [10, 11]. However, in the current market, most of mobile applies network-based handover algorithm for vertical handover. For the network-based VHO algorithm, when WiFi network is connected, all data will be downloaded and uploaded through WiFi network without considering the network condition of WiFi network. If users would like to use mobile network, the only way is to disable the WiFi interface. Considering that a WiFi network is free or cheaper than a mobile network, a VHO algorithm could be designed in a flexible way to users. Furthermore, some users also have mobile data allowance, so that they would be happy to enjoy good QoE within their mobile data allowance when the network condition of WiFi network becomes poor. The proposed VHO algorithm make handover decision based on users' preferences and QoE, thus it could be classified as user-centric QoE-driven VHO algorithm.

B. Media Independent Handover Framework

As mentioned above, the MIH framework is designed by IEEE 802.21 group to support seamless vertical handover. In MIH framework, there is a central entity called media independent handover function (MIHF). MIHF is located between network layer and link layer and supports information exchange between two different devices and handover execution. In MIHF, IEEE 802.21 defines three services: MIH information services, MIH event services and MIH command services.

MIH information services are used to collect and exchange required information between two devices. All events in lower layers will be detected by MIH event services. MIHF will generate MIH events based on detected events, and then propagate the MIH events to upper layers. Hence MIH information services and MIH event services could provide essential information for handover decision. MIH command services provide the function for MIHF to execute handover. The flows of information, events and commands in MIH framework are exhibited in Fig. 2.

MIH framework could provide seamless VHO for users, but the VHO algorithm might be the limitation. As the network-based VHO algorithm is default VHO algorithm in

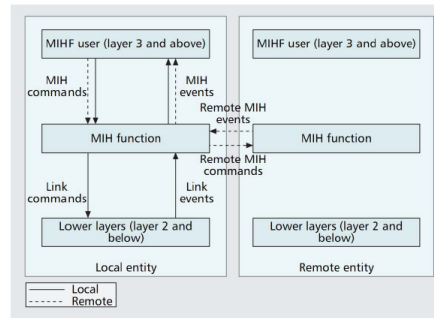

Figure 1: MIH Framework [2]

MIH framework that is not good enough to provide good QoS and QoE for users. Hence, the proposed VHO framework is designed based on MIH framework to provide better QoE for users.

III. RELATED WORK

In recent years, development of vertical handover algorithms becomes more and more popular as it still is the key challenge of mobility management in heterogeneous networks. A VHO algorithm decides the target network and the time to execute a vertical handover. If a VHO algorithm selects an inappropriate network, it would cause unnecessary cost or degradation of users' experience. However, even though a VHO algorithm selects an appropriate network to handover to, when to execute VHO still is a challenge. If a VHO execution was initiated too early or late, excessive cost or degradation of users' experience would occur. Hence, in order to make an appropriate VHO decision, the criteria of VHO algorithm should be chosen carefully. Koundourakis et al. and Zahran et al. proposed RSS-based VHO algorithms to select a target network based on the RSS [12, 13]. RSS-based VHO algorithms will select a target network which has the highest RSS. RSS-based VHO algorithms could minimize degradation in congestion situation. However, RSS-based VHO algorithms have some disadvantages such as high handover delay and time consuming. Cost function-based VHO algorithms select the best available network based on calculation of specific parameters from available networks [14-16]. They evaluate each available network and measure the sum of weighted function of specific parameters. Then, the network with the highest score will be selected as target network. Cost function-based VHO algorithms could achieve high throughput and low handover latency. However, these algorithms consider only network QoS parameters which are not directly linked with users' QoE. Calvagna, Modica and Ormond et al. proposed user-centric VHO algorithms in terms of cost and QoS [10, 11]. These algorithms tried to fulfill users' satisfaction with non-real-time applications such as FTP file transfer. However, more QoS parameters (e.g. packet loss) need to be taken into account to improve efficiency of the user-centric VHO algorithms. Moreover, their works are only limited to FTP applications without consideration of multimedia services. Some QoE-based VHO algorithms have been proposed in [8, 9, 17]. The QoE-based VHO algorithms select a target network with the highest predicted MOS that could provide relative good QoE for users. However, it is unnecessary to always connect to network with highest MOS. Always connecting to network with highest MOS could cause unnecessary handover and waste of energy. Furthermore, those QoE-based VHO algorithms ignore the video content type and cost that will affect the QoE to users. In our previous work [18], a QoE-driven VHO algorithm is proposed to maintain acceptable QoE for users. The algorithm could avoid unnecessary handover and save the energy. However, the work is only limited to QoE without consideration of user preference (e.g. cost) and the performance comparison was only carried out with a network-based VHO algorithm. In this paper, a user-centric

QoE-driven VHO framework is designed to allow users to decide how to select a network based on their budget and cost concerns. The proposed framework could be applied with different QoE-driven VHO algorithm to maintain acceptable QoE of different applications for users. Regarding to video applications, a user-centric QoE-driven VHO algorithm is also proposed in this paper to evaluate the performance of video streaming in proposed framework. Furthermore, the performance of user-centric QoE-driven VHO algorithm will be compared with QoS-based VHO algorithm.

IV. USER-CENTRIC QoE-DRIVEN VHO FRAMEWORK

A. User-centric QoE-driven VHO Framework

User-centric QoE-driven VHO framework is based on MIH framework to fulfill users' requirements with different application services in heterogeneous networks. Most of users are not care about what happen in wireless networks. From users' perspective, cost and users' experience are the most important concerns. Since users also have different requirements of cost and users' experience for different application services, it is necessary to make VHO decision based users' preferences. The procedures of user-centric QoE-driven VHO framework is shown in Fig 3. Depending on the types of application services, related QoE-Estimators and user-centric QoE-driven VHO algorithms will be applied in the proposed framework. QoE-Estimators always keep monitoring the QoE of application services. QoE-Estimators will collect related network and service parameters to predict QoE in terms of MOS. Then the predicted MOS will be sent to user-centric QoE-driven VHO algorithm. Users can set users' preferences depending on their concerns which will be considered by user-centric VHO algorithm. When multi-interfaces detect the link events, such as link up and link down, it will send related information of the link event to MIHF. Once MIHF received the link events, MIHF would generate MIH events and propagate to user-centric QoE-

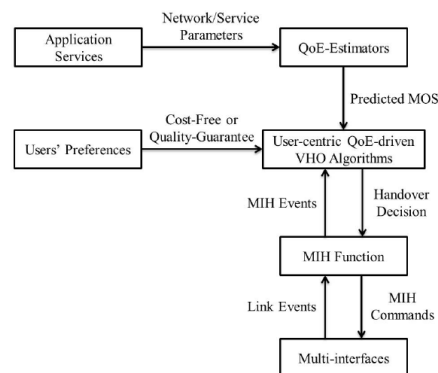

Figure 3: User-centric QoE-driven VHO Framework Procedures

driven VHO algorithm for supporting handover decision. However, the proposed VHO algorithm would only be activated by MIH event (receiving radio advertisement). If MIHF is implemented in a network access point, the access point will broadcast MIH radio advertisement to inform other MIH users. For example, if there is no other network available, to activate user-centric is kind of useless energy consumption. However, once a new available network is detected by MIHF, the user-centric QoE-driven VHO algorithm will be activated by MIH event. All required information would be analyzed to make handover decision based on users' preference. Once the handover decision is made, user-centric QoE-driven VHO algorithm will send the decision to MIHF. Then, depending on the decision, MIHF will control the multi-interfaces by MIH commands.

B. User-centric QoE-driven VHO Algorithm

A user-centric QoE-driven VHO algorithm is designed to maintain acceptable QoE of video streaming based on predicted MOS and user's preferences. Hence this algorithm could select an appropriate network to fulfill users' actual requirements during VHO. A reference-free QoE assessment model is applied to measure QoE of video streaming in the user-centric QoE-driven VHO framework as the QoE-Estimator [19]. This model is able to assess QoE of video streaming over different wireless networks based on the parameters of application and network, such as pack error rate (PER), sending bitrate (SBR) and frame rate (FR). The nonlinear equation is shown in (1). Moreover, the QoE prediction model classifies three types of video depending on the content movement of video: Slow Movement (SM), Gentle Walking (GW) and Rapid Movement (RM). Table 1 shows all coefficients of different types of content. This reference-free QoE prediction model will act as QoE-estimator to measure QoE of video streaming in user-centric QoE-driven VHO algorithm.

$$MOS = \frac{a_1 + a_2FR + a_3 \ln(SBR)}{1 + a_4PER + a_5(PER)^2} \quad (1)$$

The user-centric QoE-driven VHO algorithm allows users to decide how to select target network depending on users budgets and concerns. Fig. 4 displays procedures of user-centric QoE-driven VHO algorithm. Users could set users' preferences as quality-guarantee or cost-free. Quality-guarantee means that the proposed VHO algorithm maintains acceptable QoE of video streaming. If the users' preferences is set to cost-free, the proposed VHO algorithm works as network-based VHO algorithm. It is note that user-centric QoE-driven VHO algorithm is set to connect to new WiFi

Table 1: Coefficients of QoE Prediction Model for All Content Types

Coeff	SM	GW	RM
a1	4.5796	3.4757	3.0946
a2	-0.0065	0.0022	-0.0065
a3	0.0573	0.0407	0.1464
a4	2.2073	2.4984	10.0437
a5	7.1773	-3.7433	0.6865

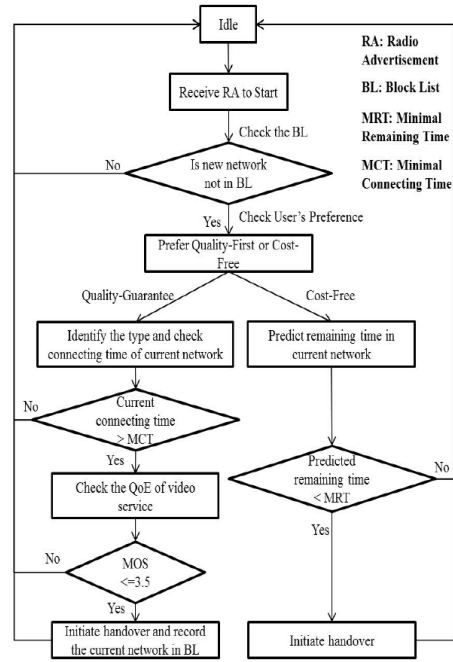

Figure 4: User-centric QoE-driven VHO Algorithm Procedures

network automatically when users are using mobile network. The reason is that WiFi networks are supposed to be cheaper than mobile network and are able to provide good QoE for users. Once user-centric QoE-driven VHO algorithm received the MIH event of receiving radio advertisement (RA), it would check the block list (BL) at first. BL is used to store the information of the networks which have been connected before and have poor network condition. If the received RA is from the network which has been stored in BL, user-centric QoE-driven VHO algorithm would just ignore this network and turn itself back to idle status. Otherwise user-centric QoE-driven VHO algorithm would continue checking the user's preference. If user's preference was set to cost-free, user-centric QoE-driven VHO algorithm would just check the remaining time in current network. If user is going to stay the coverage of current network less than minimal remaining time (MRT), user-centric QoE-driven VHO algorithm would target this network and initiate the handover execution. Otherwise, user-centric QoE-driven VHO algorithm would ignore this network and switch itself to idle status. Cost-free function could avoid extra cost for users, as user-centric QoE-driven VHO algorithm would always decide to connect to WiFi network as long as it is available. However, the acceptable QoE is not able to be guaranteed, if the user select cost-free in user-centric QoE-driven VHO algorithm.

Nevertheless, some users have some mobile data allowance and concern about the QoE, they could choose quality-guarantee function in user-centric QoE-driven VHO algorithm to maintain the acceptable QoE of video streaming. As shown in Fig. 4, if users' preference was set to quality-guarantee, user-centric QoE-driven VHO algorithm would check the type and connecting time of current connecting network firstly. Then if the current connecting time is longer than minimal connecting time (MCT), then user-centric VHO algorithm would check the QoE of video streaming. Otherwise user-centric QoE-driven VHO algorithm would become idle state. MCT is used to avoid unnecessary handover like Ping-pong, because QoE of video streaming needs time to recover the quality after handover from poor network. At the end, if predicted MOS of video streaming was more than 3.5 (value of acceptable QoE), user-centric QoE-driven VHO algorithm will decide to stay in current connecting network. Otherwise, user-centric QoE-driven VHO algorithm would initiate the handover and record the current connecting network in BL to avoid unnecessary handover. User-centric QoE-driven VHO algorithm allow users to decide how to select target network depending on their budget and interests. Hence, no matter users are concerned about QoE or prefer free service, users' different requirements could be satisfied by user-centric QoE-driven VHO algorithm.

V. PERFORMANCE EVALUATION AND ANALYSIS

A. Simulation Parameters and Topology

User-centric QoE-driven VHO algorithm is implemented in MIH framework in Network Simulator 2.29 (NS 2.29). Evalvid module also is implemented in NS 2.29 to provide video application with input video trace data. The simulations are designed to evaluate the video streaming performance of user-centric QoE-driven VHO algorithm under UMTS network and WiFi network. This simulation also plans to compare the performance of user-centric QoE-

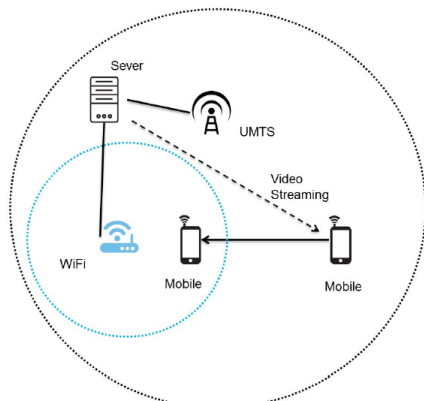

Figure 5: Simulation Topology

driven VHO algorithm and QoS-based VHO algorithm. Fig. 5 shows the topology of simulation. At the beginning of this simulation, the mobile user will use real time video application under UMTS network at 20th second. Then the mobile user will walk into and stay in office. There is WiFi router to provide free WiFi network in office. However, the WiFi network will become congestion with different packet loss rate at 56th second. Packet loss rates will be set to from 0% to 10% with the increasing of 2%. In this simulation, if packet loss rate is set to a value, packet loss rate would not always be the value. The packet loss rate would randomly change up and down around the value. However, the average packet loss rate will be the value. In this simulation, there are three H.264 videos with different types of movement are applied in this simulation to evaluate the performance of user-centric QoE-driven VHO algorithm. In order to compare the performance of different VHO algorithms, QoS-based VHO algorithm and network-based VHO algorithm also will be evaluated with same simulation scenario. The quality-guarantee function will be selected in user-centric QoE-driven VHO algorithm. For the QoS-based VHO algorithm, 8% packet loss rate will be set as the threshold for triggering the handover. Network-based VHO algorithm will be evaluated as cost-free function of user-centric QoE-driven VHO algorithm. The main simulation parameters are shown in Table 2. There are three main questions for this simulation:

- Whether user-centric QoE-driven VHO framework could maintain acceptable QoE of video streaming for users?
- Whether user-centric QoE-driven VHO algorithm could provide better QoE of video streaming for users than QoS-based VHO algorithm?
- Whether the performance of user-centric QoE-driven VHO algorithm would be affected by the difference of content movement?
- Whether user-centric QoE-driven VHO framework could maintain the acceptable QoE of video streaming and also keep the cost at reasonable low?

B. Results and Analysis

After the simulations, all results were divided into five sets based on different packet loss rates. Due to the large amount of results, a set of results with 4% packet loss rate will be displayed and analyzed as example in this paper. Furthermore, the overall MOSs of different VHO algorithms

Table 2: Simulation Parameters

Parameters	UMTS	WiFi	
Bandwidth	384 kbps	11 Mbps	
Coverage	500 m	50 m	
Parameters	Mobile User		
Speed	1 m/s		
Parameters	SM Video	GW Video	RM Video
Video Frames	3000	3000	3060
Frame rate	25	25	25
Sending Bitrate	18 kbps	256 kbps	512 kbps

also will be presented.

Fig. 6 shows the average MOS of SM video with 4% packet loss rate. When packet loss rate was set to 4%, only QoS-based VHO algorithm executed handover from WiFi to UMTS network. The other two VHO algorithms kept connecting with WiFi network until the end of simulation. QoS-based achieve best QoE of SM video in this set of simulation. However, is this handover really worthy in this situation? Even though QoS-based VHO algorithm reached high QoE, but it cost more mobile data which means more cost. User-centric QoE-driven VHO algorithm and network-based VHO algorithm did not provide relative high QoE of SM video as QoS-based VHO algorithm. But the QoE of SM video provided by user-centric QoE-driven VHO algorithm and network-based VHO algorithm are always acceptable and the MOSs were more than 4 at most of time. Furthermore, user-centric QoE-driven VHO algorithm and network-based VHO algorithm kept connecting to WiFi network which meant no extra cost. Since SM video is insensitive to packet loss, the difference of QoE between 4 and 4.5 is just slight for SM video. Thus it is unworthy to pay extra money for similar QoE of SM video. In this case, user-centric QoE-driven VHO algorithm made better decision than QoS-based VHO algorithm.

The average MOS of GW video with 4% packet loss is shown as Fig. 7. In this set of simulation, both of user-centric QoE-driven VHO algorithm and QoS-based VHO algorithm executed handover from WiFi network to UMTS network. When packet loss started happening, all of three VHO algorithms decided to stay connecting to WiFi network. At that period of time, the QoE of GW videos are acceptable. When user-centric QoE-driven VHO algorithm detected unacceptable QoE of GW video, it performed the handover from WiFi network to UMTS network immediately. However, QoS-based VHO algorithm did not detect that the QoE of GW video became unacceptable as quick as user-centric QoE-driven VHO algorithm. QoS-based VHO algorithm only noticed poor QoE of GW video until the QoE became even worse. Since user-centric QoE-driven VHO

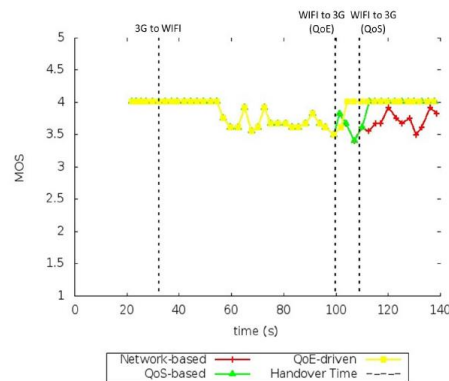

Figure 7: Average MOS of GW video under 4% packet loss

algorithm detected unacceptable QoE of GW video earlier than QoS-based VHO algorithm, it provided acceptable QoE of GW video earlier than QoS-based VHO algorithm. Even though user-centric QoE-driven VHO algorithm produced more cost than QoS-based VHO algorithm, but what the most important was that user-centric VHO algorithm fulfilled users' requirement and avoided the worse packet loss. Network-based VHO algorithm still kept connecting to WiFi network all the time. Hence user-centric QoE-driven VHO algorithm achieves better QoE of GW video than QoS-based VHO algorithms and avoid the QoE of GW video becoming unacceptable again.

Fig. 8 displays average MOS of RM video with 4% packet loss rate. In this situation, user-centric QoE-driven VHO algorithm immediately detected dramatically descent of QoE of RM video. Then user-centric QoE-driven VHO algorithm executed handover from WiFi network and mobile network around 62th second and it effectively maintained acceptable QoE of RM video for users. However, QoS-based

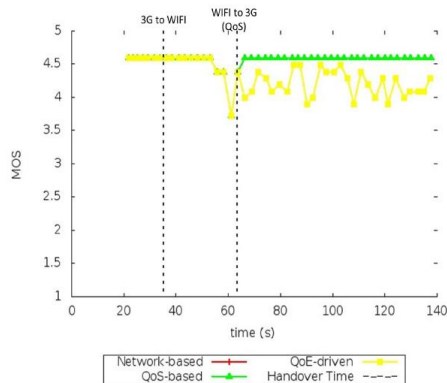

Figure 6: Average MOS of SM video under 4% packet loss

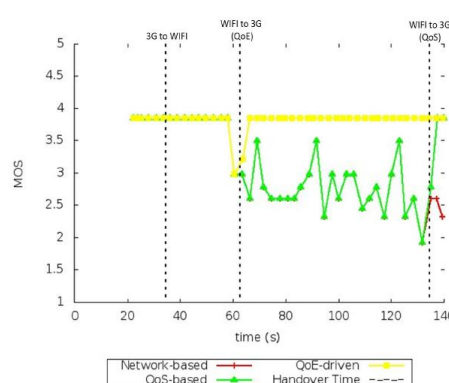

Figure 8: Average MOS of RW video under 4% packet loss

VHO algorithm failed to provide good QoE for users. When QoE of RM video significantly dropped and became unacceptable, QoS-based VHO algorithm did not detect it. Finally, QoS-based VHO algorithm noticed the terrible QoE of RM and made handover decision quite late about 135th second. Since RM video is very sensible to packet loss, packet loss could seriously affect the QoE of RM video. Hence, QoS-based VHO algorithm cannot identify the significant degradation of QoE of RM video by only considering packet loss rate. It is clear that the performance of user-centric QoE-driven VHO algorithm was much better than QoS-based VHO algorithm. QoS-based VHO algorithm provided around 75 seconds terrible and unacceptable QoE of RM video for users. The performance of network-based VHO algorithm also was terrible, but it was understandable and acceptable by users. Because users selected cost-free function in user-centric QoE-driven VHO algorithm that meant the users did not concern much about QoE and prefer no extra cost.

In order to analyze and compare overall performance of three VHO algorithms, the overall MOSs of three different videos under diverse packet loss rates are shown in Fig. 9, 10 and 11. Note that overall MOS represents the QoE from the beginning of video application to the end. The overall MOS of SM video under diverse packet loss rate is displayed as Fig. 9. QoS-based VHO algorithm always maintained the overall QoE at almost perfect level around 4.5. When packet loss rate increased from 0% to 6%, the overall QoE of user-centric QoE-driven VHO algorithm and network-based VHO algorithm were same (more than 4) and decreased with the increasing of packet loss rate. Nevertheless, when packet loss rate became more than 6%, user-centric QoE-driven VHO algorithm detected unacceptable QoE of SM video and executed handover from WiFi network to UMTS network for maintaining acceptable QoE for users. But network-based VHO algorithm still kept connecting to WiFi network and its QoE of SM video carried on dropping with packet loss rate increasing. For SM video, QoS-based VHO algorithm seems

could provide better QoE for users than user-centric QoE-driven VHO algorithm. However, there was no significant difference of QoE between user-centric QoE-driven VHO algorithm and QoS-based VHO algorithm. Moreover overall QoE of both VHO algorithms were blameless. But QoS-based VHO algorithm created more cost on mobile network. There is meaningless to make users pay extra for similar QoE of SM video.

Fig. 10 depicts the overall MOS of GW video under different packet loss rates. For GW video, the performance of user-centric QoE-driven VHO algorithm and QoS-based VHO algorithm were similar. It is clear that both of user-centric QoE-driven VHO algorithm and QoS-based VHO algorithm detected QoE dropping, when the packet loss rate was set to 4%. Furthermore, the performance of user-centric QoE-driven VHO algorithm is slight better than QoS-based VHO algorithm. Then, with the enlargement of packet loss rate, the performance of user-centric QoE-driven VHO algorithm and QoS-based VHO algorithm were almost same. For network-based VHO algorithm, the overall QoE of GW video decreased with the increment of packet loss rate.

Fig. 11 shows the overall MOS of RM video with diverse packet loss rates. It is obvious that user-centric QoE-driven VHO algorithm successfully maintained QoE of RM video for users, no matter how packet loss rate changed. For QoS-based VHO algorithm, when packet loss rate was set to 2% and 4%, the QoE of RM video became unacceptable. Once packet loss rate increased to 6% and over, the performance of QoS-based VHO algorithm got close to user-centric QoE-driven VHO algorithm. Since QoS-based VHO algorithm only take packet loss rate into consideration so that it cannot notice the serious degradation of QoE of RM video. In terms of network-based VHO algorithm, the QoE of RM video dramatically decreased with packet loss rate increasing. Thus, regarding to RM video, user-centric QoE-driven VHO algorithm accomplished best performance among three VHO algorithms. Even though RM video is easy to be affected by packet loss rate, user-centric QoE-driven VHO algorithm

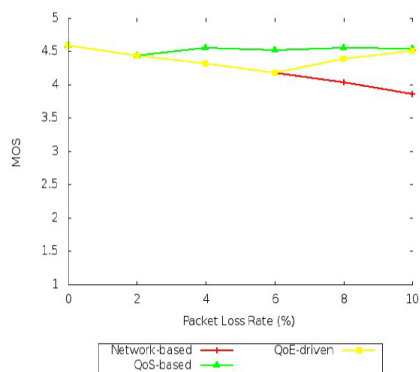

Figure 9: Overall MOS of SM video under different packet loss rate

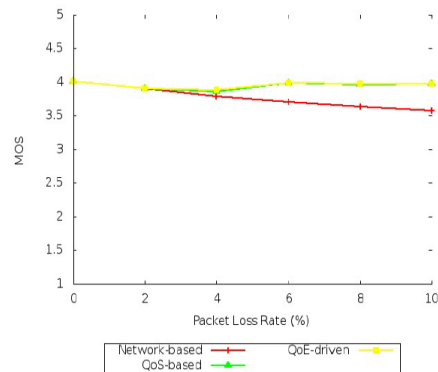

Figure 10: Overall MOS of GW video under different packet loss rate

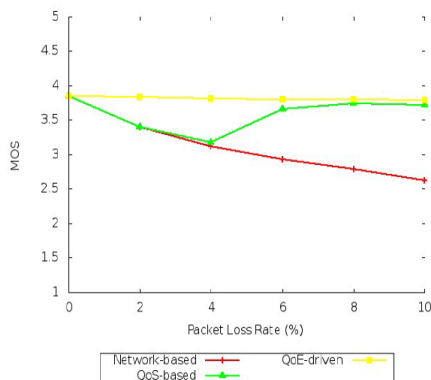

Figure 11: Overall MOS of RM video under different packet loss rate

still maintain the brilliant QoE of RM for users.

VI. CONCLUSION AND FUTURE WORK

This paper proposed a user-centric QoE-driven VHO framework to allow users to set users' preferences to cost-free or quality-guarantee depending on their budget and concern. Through several sets of simulation, the performance of user-centric QoE-driven VHO framework has been evaluated in terms of video streaming services. Furthermore user-centric QoE-driven VHO algorithm is compared with QoS-based VHO algorithm with diverse packet loss rates and three video with different types of content movement. The results showed that, firstly, the user-centric QoE-driven VHO framework can effectively maintain acceptable QoE of video streaming for users. Secondly, the user-centric QoE-driven VHO algorithm can provide better users' satisfaction of video streaming than that of QoS-based VHO algorithm. Thirdly, the performance of user-centric QoE-driven VHO algorithm would not be affected by content movement of video. Finally, user-centric QoE-driven VHO framework can maintain an acceptable QoE of video streaming, meanwhile it also can avoid unnecessary handover and cost. Hence, the user-centric QoE-driven VHO framework is able to maintain QoE of different application services in heterogeneous networks.

In the future, a video adaptation scheme will be utilized to improve performance for the user-centric QoE-driven VHO framework. Other application services (such as VoIP and video gaming) will also be taken into account and their performance will be evaluated in the user-centric QoE-driven VHO framework.

REFERENCES

- [1] Cisco. (June 2016). *Cisco Visual Networking Index: Forecast and Methodology, 2015-2020*. Available: <http://www.cisco.com/c/en/us/solutions/collateral/service-provider/visual-networking-index-vni/complete-white-paper-c11-481360.html>
- [2] O. Khattab and O. Alani, "Survey on Media Independent Handover (MIH) Approaches in Heterogeneous Wireless Networks," in *Wireless Conference (EW), Proceedings of the 2013 19th European*, 2013, pp. 1-5.
- [3] A. De La Oliva, A. Banchs, I. Soto, T. Melia, and A. Vidal, "An overview of IEEE 802.21: media-independent handover services," *Wireless Communications, IEEE*, vol. 15, pp. 96-103, 2008.
- [4] M. Zekri, B. Jouaber, and D. Zeghlache, "A review on mobility management and vertical handover solutions over heterogeneous wireless networks," *Computer Communications*, vol. 35, pp. 2055-2068, 2012.
- [5] M. Kassab, B. Kervella, and G. Pujolle, "An overview of vertical handover decision strategies in heterogeneous wireless networks," *Computer Communications*, vol. 31, pp. 2607-2620, 2008.
- [6] J. Marquez-Barja, C. T. Calafate, J. C. Cano, and P. Manzoni, "An overview of vertical handover techniques: Algorithms, protocols and tools," *Computer Communications*, vol. 34, pp. 985-997, Jun 2011.
- [7] A. Khan, L. Sun, E. Jamme, and E. Ifeachor, "Quality of experience-driven adaptation scheme for video applications over wireless networks," *IET Communications* 4(11), 1337-1347.
- [8] J. Jailton, T. Carvalho, W. Valente, C. Natalino, R. Frances, and K. Dias, "A quality of experience handover architecture for heterogeneous mobile wireless multimedia networks," *Communications Magazine, IEEE*, vol. 51, pp. 152-159, 2013.
- [9] K. Pianrat, A. Ksentini, C. Vito, and J. Bonnin, "QoE-based network selection for multimedia users in IEEE 802.11 wireless networks," in *Local Computer Networks, 2008. LCN 2008. 33rd IEEE Conference on*, 2008, pp. 388-394.
- [10] A. Calvagna and G. D. Modica, "A user-centric analysis of vertical handovers," presented at the Proceedings of the 2nd ACM international workshop on Wireless mobile applications and services on WLAN hotspots, Philadelphia, PA, USA, 2004.
- [11] O. Ormond, J. Murphy, and G. m. Muntean, "Utility-based Intelligent Network Selection in Beyond 3G Systems," in *2006 IEEE International Conference on Communications*, 2006, pp. 1831-1836.
- [12] G. Koundourakis, D. I. Axiotis, and M. Theologou, "Network-Based Access Selection in Composite Radio Environments," in *2007 IEEE Wireless Communications and Networking Conference*, 2007, pp. 3877-3883.
- [13] A. H. Zahran, B. Liang, and A. Saleh, "Signal threshold adaptation for vertical handoff in heterogeneous wireless networks," *Mob. Netw. Appl.*, vol. 11, pp. 625-640, 2006.
- [14] A. Hasswa, N. Nasser, and H. Hassanein, "Tramcar: A Context-Aware Cross-Layer Architecture for Next Generation Heterogeneous Wireless Networks," in *Communications, 2006. ICC '06. IEEE International Conference on*, 2006, pp. 240-245.
- [15] R. Tawil, G. Pujolle, and O. Salazar, "A Vertical Handoff Decision Scheme in Heterogeneous Wireless Systems," in *Vehicular Technology Conference, 2008. VTC Spring 2008. IEEE*, 2008, pp. 2626-2630.
- [16] Z. Fang and J. McNair, "Optimizations for vertical handoff decision algorithms," in *Wireless Communications and Networking Conference, 2004. WCNC. 2004 IEEE*, 2004, pp. 867-872 Vol.2.
- [17] C. Quadros, E. Cerqueira, A. Neto, A. Pescape, A. Riker, R. Immich, et al., "A quality of experience handover system for heterogeneous multimedia wireless networks," in *Computing, Networking and Communications (ICNC), 2013 International Conference on*, 2013, pp. 1064-1068.
- [18] L. Liu, L. Sun, and E. Ifeachor, "A QoE-driven vertical handover algorithm based on media independent handover framework," in *Wireless and Mobile Computing, Networking and Communications (WiMob), 2015 IEEE 11th International Conference on*, 2015, pp. 51-58.
- [19] A. Khan, L. Sun, and E. Ifeachor, "Content Clustering Based Video Quality Prediction Model for MPEG4 Video Streaming over Wireless Networks," in *2009 IEEE International Conference on Communications*, 2009, pp. 1-5.