

2019

Data Sonification in Creative Practice

Bonet Filella, Nuria

<http://hdl.handle.net/10026.1/14583>

<http://dx.doi.org/10.24382/937>

University of Plymouth

All content in PEARL is protected by copyright law. Author manuscripts are made available in accordance with publisher policies. Please cite only the published version using the details provided on the item record or document. In the absence of an open licence (e.g. Creative Commons), permissions for further reuse of content should be sought from the publisher or author.



**UNIVERSITY OF
PLYMOUTH**

**DATA SONIFICATION IN
CREATIVE PRACTICE**

by

Núria Bonet Filella

A thesis submitted to the University of Plymouth

in partial fulfilment for the degree of

DOCTOR OF PHILOSOPHY

School of Humanities & Performing Arts

September 2018

Copyright © 2018

This copy of the thesis has been supplied on condition that anyone who consults it is understood to recognise that its copyright rests with its author and that no quotation from the thesis and no information derived from it may be published without the author's prior consent.

Acknowledgements

I have spent a lot of time thinking about what a PhD is and why I should persevere with it. I have concluded that it is an academic apprenticeship which will set me up for my future career. The lessons learnt on this journey are far larger than can be expressed in the thesis and the portfolio. This would not have been possible without many people, some of whom I wish to thank specifically.

It has been a privilege to work under Prof Eduardo Miranda who has provided continued support and inspiration. I thank him for his advice, time and last-minute all-important emails. He has allowed me the freedom to develop my practice and ideas while trusting that I would get there in the end.

Dr Alexis Kirke has provided the ideal counter-balance as 2nd supervisor and I have sought to understand and at times emulate his practice. His success in bringing ideas alive has inspired me to believe in my own ideas, whether inspired or outrageous. This has given me an edge but also an understanding of the murky world of surviving and thriving in academia and the media.

A PhD can be very isolating, so it would have been impossible to survive without the company of the ICCMR crew: Ed Braund, Jared Drayton, Ben Payne, Aurélien Antoine, Satvik Venkatesh, Michael McLoughlin, Federico Visi, Pierre-Emmanuel Largeron, Duncan Williams, Joel Eaton. The proximity to the Theatre and Performance department means that I have also spent many lunchtimes and late evenings in company of many other scholars: Charlotte Storey, Josh Slater, Victor De Ladrón Guevara, Natalie Raven, and many more.

I would like to thank Simon Ible for playing my music and taking time to hone my skills. The respect that he and the Ten Tors Orchestra have shown me has encouraged me to persevere with my instrumental music.

I could not have survived the gruelling academic demands without the distraction and love from friends. I would like to thank Fran and Stacey for being true friends and cracking neighbours. All the times that I walked in unannounced, had dinner cooked for or talked over whichever programme we were watching kept me sane. Further down the road, the Fawn Social Club has been my home from home. You have kept me entertained, occupied, accompanied, hydrated, fed, astonished, distracted, and most importantly, accepted. I wish everyone had a Fawn Social Club in their life.

Finally, nothing would be possible without Montserrat Filella. She is an endless source of wisdom, encouragement and love. My best decisions can be traced back to her and she is truly a leading light in my life. *Gràcies mama.*

Author's Declaration

At no time during the registration for the degree of Doctor of Philosophy has the author been registered for any other University without prior agreement of the Doctoral College Quality Sub-Committee.

Work submitted for this research degree at the University of Plymouth has not formed part of any other degree either at the University of Plymouth or at another establishment.

The writing-up of the thesis was financially supported by the Bourse Michelle of the FOCUNA foundation (Luxembourg).

A record of activity detailing the publications and conference presentations can be found in Chapter 8.

Word count of main body of thesis: 46,660

Signed

Date.....

Abstract

Data Sonification in Creative Practice

Núria Bonet Filella

Sonification is the process of data transmission with non-speech audio. While finding increasing acceptance as a scientific method, particularly where a visual representation of data is inadequate, it is still often derided as a 'gimmick'. Composers have also shown growing interest in sonification as a compositional method. Both in science and in music, the criticism towards this method relates to poor aesthetics and gratuitous applications. This thesis aims to address these issues through an accompanying portfolio of pieces which use sonification as a compositional tool. It establishes the principles of 'musification', which can be defined as a sonification which uses musical structures; a sonification organised by musical principles. The practice-as-research portfolio explores a number of data sources, musical genres and science-music collaborations.

The main contributions to knowledge derived from the project are a portfolio of compositions, a compositional framework for sonification and an evaluation framework for musification. This thesis demonstrates the validity of practice-as-research as a methodology in sonification research.

Table of Contents

1. Introduction	1
1.1 Research Context	3
1.2 Research Aims	5
1.3 Research Questions	6
1.4 Research Methods and Strategies	6
1.4.1 Literature Review	6
1.4.2 Practice-as-Research	7
1.4.3 Software	9
1.4.4 Evaluation	10
1.4.5 Between Methodologies	10
1.5 Thesis Overview	11
2. From Sonification to Musification	13
2.1 Sonification	13
2.1.1 Audification	13
2.1.2 Parameter Mapping Sonification (PMSon)	14
2.1.3 Auditory Icons	17
2.1.4 Model-based Sonification	18
2.1.5 Further Techniques	19
2.2 Towards a Definition	19
2.2.1 Auditory Display	21
2.2.2 Functional Sounds	22
2.3 Aesthetics	23
2.3.1 Aesthetics in Sonification	23
2.3.2 Aesthetics and Beauty	24
2.3.3 Psychoacoustics and Human Perception	25
2.4 Sonification and Music	27
2.4.1 ICAD	27
2.4.2 Popularity	28
2.4.3 Further Criticisms	29
2.5 Music	29

2.6 Musification	33
2.7 Trends in Musification	36
2.7.1 Natural Organisms	37
2.7.2 Human Body	39
2.7.3 Environment	41
2.7.4 Weather and Climate	44
2.7.5 Astronomy and Particle Physics	46
2.8 Conclusion	50
2.8.1 Musification	50
2.8.2 Challenges	50
2.8.3 Proposed Solutions	51
3. <i>Blyth-Eastbourne-Wembury</i>: A Framework for Musification	52
3.1 Overview	52
3.1.1 Compositional Process	53
3.2 Data	54
3.2.1 Temperature	54
3.2.2 Salinity	54
3.2.3 Telling Climate Change	55
3.3 Mappings	59
3.3.1 Temperature	59
3.3.2 Salinity	60
3.3.3 Software	61
3.4 Musical Language	61
3.4.1 Sonification	61
3.4.2 Soundscape Composition	62
3.4.3 Musification	63
3.5 Emotional Content	64
3.5.1 Empathetic Sonification	64
3.5.2 Sonification	65
3.5.3 Soundscape	66
3.5.4 Geosonification	68

3.5.5 Sonification as Sound Source	69
3.6 Performance	71
3.7 Framework	74
3.7.1 Data	74
3.7.2 Mappings	75
3.7.3 Musical Language	76
3.7.4 Emotional Content	77
3.8 Conclusions	77
4. <i>The Sonification of Dark Matter: Interdisciplinary Collaboration and the Scientist-Composer</i>	79
4.1 Overview	79
4.1.1 Aims	80
4.1.2 Dark Matter	79
4.1.3 Challenges	82
4.1.4 Compositional Process	83
4.2 Data	83
4.2.1 First Approach: Data Files	84
4.2.2 Second Approach: Data Extraction from Visualisations	87
4.3 Mappings	88
4.3.1 Visualisation Mappings	88
4.3.2 Primary and Secondary Parameters	89
4.3.3 Hierarchies in Music	90
4.3.4 Mappings: Experimental Approach	91
4.3.5 Mappings: Warm Dark Matter Halo	91
4.3.6 Mappings: Dark Matter Streams	92
4.3.7 Mappings: Dark Universe	92
4.4 Musical Language	92
4.5 Emotional Content	94
4.6 Performance	95
4.7 Collaboration	95
4.7.1 Types of Collaboration	97
4.7.2 Example of Working Relationships in Sonification	97

4.7.3 Working Relationships in <i>The Sonification of Dark Matter</i>	99
4.7.4 Challenges of Collaboration	100
4.7.5 Criticisms of Collaboration	101
4.7.6 Potential Solutions for Problems in Collaborations	102
4.8 Scientist-Composer	104
4.9 Conclusions	106
5. <i>The Voice of the Sea: Echoing our Environment</i>	108
5.1 Overview	108
5.1.1 Compositional Process	110
5.2 Data	110
5.3 Mappings	112
5.3.1 Synthesised Sounds: Beeps	114
5.3.2 Recorded Sounds: Ocean Sounds	116
5.3.3 Recorded Sounds: Pebbles	117
5.3.4 Synthesised Sounds: Bass Beat	119
5.3.5 Recorded Sounds: Boats and Seagulls	120
5.3.6 Two Recorded Sounds: 2d.wave~ and Ocean Sounds	120
5.4 Performance	120
5.5 Musical Language	123
5.5.1 Soundscape Music	123
5.5.2 Spatialisation	124
5.6 Emotional Content	126
5.6.1 (Re-)creating a Soundscape	126
5.6.2 Empathetic Sonification	127
5.6.3 Climate Change	129
5.6.4 A Tradition	129
5.6.5 Sound Buoys	133
5.7 Collaboration	134
5.8 Conclusions	135
6. <i>Wasgiischwashäsch: Musical Borrowing in Musification</i>	137
6.1 Overview	137

6.1.1 Compositional Process	138
6.2 Data	138
6.3 Using the <i>William Tell Overture</i>	138
6.4 Mappings	143
6.5 Musical Language	146
6.5.1 Listening to Climate Change Data	146
6.5.2 Which Musical Language?	147
6.5.3 Scientist-Composer	148
6.5.4 Orchestral Sonification	150
6.6 Emotional Content	151
6.6.1 Musical Borrowing	151
6.6.2 Remix	152
6.6.3 Arrangement	153
6.6.4 Musical Literacy	154
6.6.5 Humour	154
6.7 Information Transmission Process	156
6.7.1 Shannon-Weaver Mathematical Theory of Communication	157
6.7.2 Noise and Feedback	160
6.7.3 Context in the Shannon-Weaver Model	161
6.8 Conclusions	163
7. An Evaluation Framework for Musification	164
7.1 Evaluating Sonification	165
7.1.1 Sonification Evaluation Criteria	166
7.2 Evaluating Music	170
7.2.1 Lack of Contextualisation	170
7.2.2 GCSE Assessment Criteria	171
7.2.3 'Something to hold on to' factor	174
7.2.4 Musical Evaluation in Musification	174
7.3 Evaluating Musification	175
7.3.1 Combining Existing Musification Evaluation Criteria	175
7.3.2 Description of Proposed Criteria	178
7.3.3 Evaluation Chart	180

7.4 Conclusions	181
8. Conclusions	183
8.1 Summary	183
8.1.1 Research Questions	183
8.1.2 Research Outcomes	187
8.1.3 Contributions to Knowledge	189
8.2 Performances and Impact	191
8.2.1 Performances	191
8.2.2 Impact	192
8.2.3 Conferences	192
8.2.4 Publications	193
8.3 Implications and Future Research	194
References	197
Appendix 1: Score of <i>Wasgiischwashäsch</i>	
Appendix 2: CD with Recordings of the Pieces	

List of Illustrations

1.1	Transcription of the ringtone GW Chill Out.	2
1.2	Gartner Hype Cycle of Technology. <u>1</u> is the Innovation Trigger, <u>2</u> is the Peak of Inflated Expectations, <u>3</u> is the Trough of Disillusionment, <u>4</u> is the Slope of Enlightenment, <u>5</u> is the Plateau of Productivity.	5
1.3	A for mixed mode research showing the inter-relatedness of 'practitioner knowledge', 'critical reflection' and a 'conceptual framework' in practice-as-research (Nelson, 2006, p. 114).	7
2.1	Anscombe's Quartet datasets plotted on x-y axis.	16
2.2	Hermann's systemic map of sound.	22
2.3	The Ars Informatica-Ars Musica Aesthetic Perspective (Vickers and Hogg, 2006, p. 214).	27
2.4	Artistic-Functional Spectrum of musification.	36
2.5	Evaluation chart for musification. The y-axis stands for the question (a) how effective is the musification as an auditory display? The x-axis stands for the question (b) how musically accomplished is the musification? The dotted square is the area that we are aiming for.	36
2.6	Higgs boson data (Credit: ATLAS collaboration; copyright CERN), showing the number of events observed plotted against the invariant mass in GeV. The lower register shows the background as a straight line, highlighting the appearance of the "bump" at 126.5 GeV, interpreted as the invariant mass of the observed Higgs particle. (Pesic and Volmar, 2014)	49
2.7	Sonification by Domenico Vicinanza, from LHC Open Symphony. (Pesic and Volmar, 2014)	50
3.1	Eastbourne on a map (Joyce, 2006, p. 7).	57
3.2	Monthly averages of seawater temperature at Eastbourne for the entire data set and for 1971-2000 (Joyce, 2006, p. 64).	58
3.3	Salinity at position P2 on the ferry route between from Harwich to Rotterdam for the year 2003 (Joyce, 2006, p. 144).	59
3.4	Progression of recorded sounds in <i>Blyth-Eastbourne-Wembury</i> from natural source-bonded spaces to mechanical source-bonded spaces.	67
3.5	Sonogram of <i>Blyth-Eastbourne-Wembury</i> extracted from Audacity, it describes the amplitude against time. The numbered events are described in 3.5.5.	70
3.6	Hut in the jungle biome of the Eden Project where the pair of stereo loudspeakers was situated for the performance on 9 October 2015.	73
3.7	Jungle biome at the Eden Project seen from the outside during the time of the performance.	73
4.1	Visualization of a warm dark matter halo simulation. Visualization by Ralf Kähler and Tom Abel, simulation by Oliver Hahn and Tom Abel (Kähler, Abel and Hahn, 2012).	80
4.2	Visualization of a dark matter streams simulation. Visualization by Ralf Kähler and Tom Abel, simulation by Oliver Hahn and Tom Abel (Kähler, Abel and Hahn, 2012).	84

4.3	Visualization of a simulation of the large-scale structure of the universe (LSS). Visualization by Ralf Kähler and Tom Abel, simulation by Oliver Hahn and Tom Abel (Kähler, Abel and Hahn, 2012).	87
4.4	Process from data to sonification. The left side shows the typical method for data sonification, the right side shows the modified method needed to deal with dark matter simulation data.	88
5.1	Location of the Looe buoy (red square) and location of Plymouth (green square), taken from the Channel Coastal Observatory website.	109
5.2	Korg Nanokontrol 2 and its assigned functions. 1. Set the numbers to be fed through if not using real-time data stream. 2. Reload webcam website. 3. Turn sound on in Max 7. 4. Reset number stream to zero. 5. Start the beeps. 6. Stop the beeps. 7. Start the ocean sounds. 8. Stop the ocean sounds. 9. Start the pebble sounds. 10. Stop the pebble sounds. 11. Pitch shift the pebble texture. 12. Start the bass sound. 13. Stop the bass sound. 14. Control the gain of the noise signal for the bass sound. 15. Start the boats and seagulls sound #1. 16. Stop the boats and seagulls sound #1. 17. Randomise the phasor~ object for the boats and seagulls sound #1. 18. Control the gain of the saw signal #1 for the bass sound. 19. Start the boats and seagulls sound #2. 20. Stop the boats and seagulls sound #2. 21. Randomise the phasor~ object for the boats and seagulls sound #2. 22. Control the gain of the saw signal #2 for the bass sound. 23. Start the ocean sounds with 2d.wave~. 24. Stop the ocean sounds with 2d.wave~. 25. Randomise the phasor~ object for the ocean sounds with 2d.wave~. 26. Send maximum value. Sliders for gain control: ① Beeps ② Ocean sounds ③ Pebble sounds ④ Bass sound ⑤ Boats and seagull sounds #1 ⑥ Boats and seagull sounds #2 ⑦ Ocean sounds with 2d.wave~ ⑧ Master volume control	113
5.3	The left column shows the modulation index envelopes; the horizontal axis denotes time domain of 781.25 ms and the vertical axis denotes the modulation index for values from 0 to 24. The right column shows the amplitude envelope for each note; the horizontal axis denotes the time domain of 781.25 ms and the vertical axis denotes the amplitude for values between 0 and 24. The first row shows the envelopes for the initial notes, the second row to fifth rows are for waveheights between 0 and 100 cm, 101 and 200 cm, 201 and 300 cm, and 301 and 600 cm, respectively.	116
5.4	Objects controlling the texture using recordings of pebbles.	118
5.5	Performance instructions used by the composer, showing the controller and its assigned functions.	122
5.6	From left to right, stereophonic, quadrophonic and octophonic speaker distributions.	126
5.7	Frequency and intensity of music from renaissance vocal music to 19th-Century Orchestral Music, within the range of human audibility (Schafer, 1977, p. 116).	131
6.1	Deviation of average yearly temperature in Switzerland, 0.0 on the y-axis is the overall average temperature value. In red are the years above average and in blue the years below average. The black line is the weighted average. (MeteoSchweiz, 2015a)	139
6.2	In red, the temperature deviations from the average in Switzerland. In black, the global temperature deviations from the average. (MeteoSchweiz, 2015b)	140

6.3	Comparison of the beginning of the third movement of the <i>William Tell Overture</i> and the first movement of <i>Wasgiischwashäsch</i> . Note that the cor anglais sounds a fifth below the written pitch, so the first five bars of both are identical. In continuation, the Bb clarinet part has some diminished intervals (b. 6-8) and the melodica part has a chromatic run (b. 13).	146
6.4	Ending passage of <i>Wasgiischwashäsch</i> , at tempo $J = 40$ (bars 298-303).	148
6.5	Shannon-Weaver Mathematical Theory of Communication applied to the sonification process (in italics). The terms in boxes describe the five parts of the communication process, while the annotated arrows describe the transmission between parts. Noise is an external influence on the channel which can distort the signal and the feedback describes the message returned from the Receiver to the Sender.	160
7.1	Evaluation chart for musification.	181
8.1	Hermann's systemic map of sound, where (b) is musification.	185

List of Tables

2.1	Anscombe's Quartet's statistical properties and their values, these are nearly identical for the four datasets.	16
3.1	Mean and standard deviation of monthly sea temperatures in C° for Eastbourne, for the whole data set and for the period 1971 – 2000.	58
3.2	Salinity values in psu at Position 2 for the period 2002-2004 on the Harwich-Rotterdam ferry.	58
3.3	Sound sources for the acousmatic soundscape in <i>Blyth-Eastbourne-Wembury</i> .	67
4.1	Forms of working relationship (Taylor, 2016, p. 570).	96
6.1	The left column shows the original instrumentation of the <i>William Tell Overture</i> . The right column shows the instrumentation of <i>Wasgiischwashäsch</i> , italics denote an instrument that was not originally part of the Peninsula Arts Sinfonietta.	142
6.2	The Shannon-Weaver model is described on the left, it is applied to the process of sonification on the right.	159
7.1	Sonification evaluation criteria proposed by Vogt (Vogt, 2011).	169
7.2	Sonification evaluation criteria proposed by Williams (Williams, 2016).	168
7.3	Composition assessment grid for GCSE examinations of the AQA exam board (AQA, 2018, pp. 23-24 and pp. 42-48).	173
7.4	Comparison of evaluation criteria of sonification and musification respectively, as found in Vogt, 2011; Williams, 2016; Barrass et al., 2006; and proposed criteria for musification evaluation.	176
7.5	Proposed evaluation criteria for musification, questions used to determine them, and artistic (A Rating) and functional (F Rating) rating.	179

Chapter 1

Introduction

On 11 February 2016, the Laser Interferometer Gravitational-Wave Observatory (LIGO) and Virgo Scientific Collaboration announced the first observation by LIGO detectors of gravitational waves, coming from the merging of a pair of black holes (Castelvecchi and Witze, 2016). Due to the time difference with Washington, DC, I heard about the discovery in the evening; my mother jokingly mentioned in an email that someone would have made music with the gravitational waves by the time I woke up. I received another email from her before I woke up the next day, with a link to ringtones apparently composed from the sound of gravitational waves (El País, 2016). This development favoured me because I was due to present my work on the sonification of dark matter two weeks later, at the Peninsula Arts Contemporary Music Festival 2016. The interest of journalists was awakened, and I gave interviews to the *Observer* (Davis, 2016), *Independent* (Clark, 2016) and *Physics World* (Banks, 2016); I was also later mentioned in *Nature Physics* (Miranda, 2016).

While I was grateful for the serendipitous coincidence of events, I was also concerned about the quality of those first sonifications of gravitational waves. To me, they were musically poor, the science behind it was unclear, and yet, they had been featured in major global newspapers. The ringtone *GW Chill out* (LIGO Multimedia, 2016) is a perfect example of all the pitfalls in creating music with sonifications. It surprised me that gravitational waves should sound in a Western classical scale and fit into 4/4 metre (Fig. 1.1); it was only after reading the documentation on the LIGO website and listening to it again that I understood

where the sonification was hiding. In fact, most of the ringtone had been composed with no reference to gravitational waves; it was only the final sinusoidal chirp that was indeed mapped from data to sound. I could not help but feeling like the scientists had inflated their sonification in an attempt to make it interesting, thereby losing most of the purpose of the sonification and also misleading the listener.



Fig. 1.1: Transcription of the ringtone *GW Chill Out*. The sinusoidal chirp which has been mapped from the data of the merger of a pair of black holes is shown in red.

Unfortunately, this type of sonification efforts will be the one that most scientists, musicians and the public will hear in the news. Too often, poor sonifications will be ornamented with irrelevant accompaniments because the musical quality of the data mapping is indeed poor. It is not a surprise then, that sonification is often derided by scientists as a novelty method best suited to the post-conference entertainment. Musicians are deterred by poor musical quality. In this case, I had neither the time nor the influence to create a ‘good’ sonification of gravitational waves before a ‘bad’ one came out. This experience is an example for a multitude of issues discussed in this thesis, from the difficulties of creating good sonification, the difficulty of collaborating with scientists, the need to become a scientist-composer, and perhaps, most of all, the difficulty of it all.

1.1 Research Context

Sonification has become increasingly popular since the 1990s when it reached critical mass (Supper, 2012a, p. 10); it is in fact increasingly common to hear sonification on the radio, for example. The anecdote described above demonstrates the hunger for auditory display of data even when the musical result is often dubious. The first conference of the International Community for Auditory Display was held in Santa Fe, US, in 1992; this corresponds to the surge of interest in the practice. Examples of sonification can however be found before this date, most famously perhaps Alvin Lucier's 1965 piece *Music for Solo Performer*.

The increasing appetite for sonification is understandable in a world with increasingly complex data and information; in an era of big data humans long for 'additional [cognitive] bandwidth' (Scaletti and Craig, 1991, p.10) to comprehend their surroundings. As the sheer volume of data available is rapidly increasing, we need new methods to make sense of the data. Numbers in themselves are not information; scientists are 'data interpreters' (Boyd and Crawford, 2013, p. 197). Sonification might help to understand the world that is not perceivable visually. In any case, it is clear that it attracts a range of audiences towards scientific topics regardless of its actual utility.

The proliferation of sonification makes sense within the context of increasing data availability; the discipline has however reached a critical point. The practice is still contested despite its increasing visibility (Supper, 2014, p.10). It attracts scientists and musicians but it has yet to produce a 'killer application': an application that is 'so convincing that it would make "buy into" the idea of sonification in general, contributing to its acceptance [...]' (Supper, 2014, p. 102).

The 'Hype Cycle of Technology' ¹ is a methodology used to describe the life cycle of new technologies. According to it, a new technology rapidly grows in popularity, before peaking and failing to produce a convincing or lasting application. After slumping to the 'Trough of Disillusionment', further research finally finds applications which steer the technology towards a steady 'Plateau of Productivity' (Fig. 1.2).

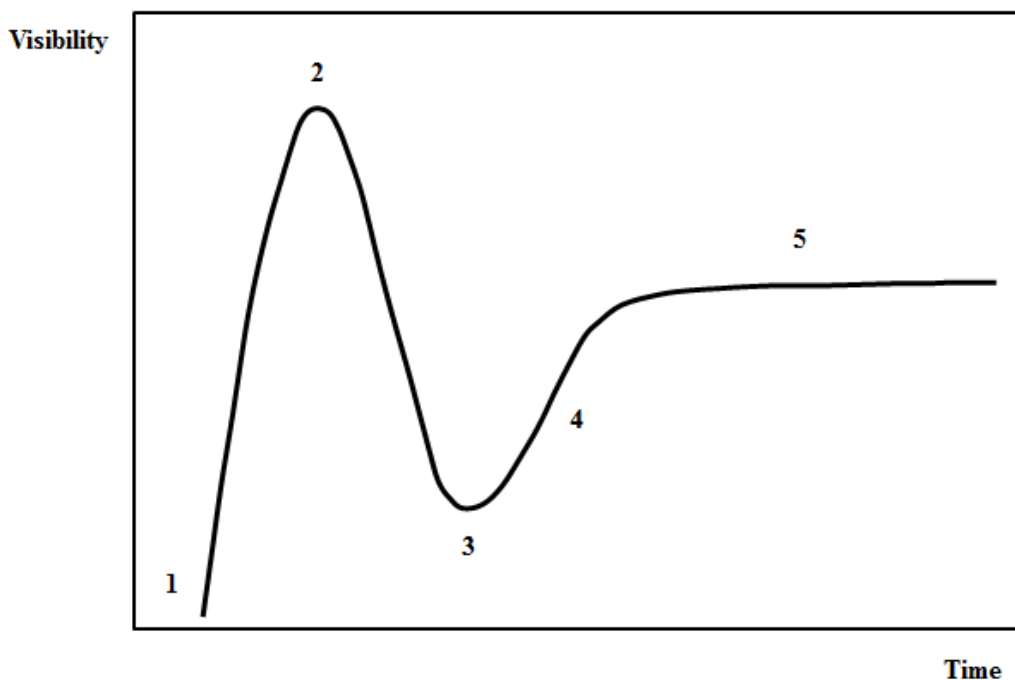

Fig. 1.2: Gartner Hype Cycle of Technology. 1 is the Innovation Trigger, 2 is the Peak of Inflated Expectations, 3 is the Trough of Disillusionment, 4 is the Slope of Enlightenment, 5 is the Plateau of Productivity.

The 'Hype Cycle of Technology' presents an interesting analogy for the life cycle of sonification. It is my view that we are now steering towards the Slope of Enlightenment: after reaching a quantitative peak, we must now aim towards qualitative improvements. Fields such as virtual and augmented reality are following a similar hype cycle, as they provoke much curiosity and investment

¹ <http://www.gartner.com/technology/research/methodologies/hype-cycle.jsp>

while not quite finding its killer application. *Google Glass*, for example, are augmented reality spectacles which were a commercial flop but have found a real-life application in manufacturing (Naughton, 2017). To sum up, sonification must overcome the hype surrounding it to find an application for which it is truly suited, whether for scientists or composers.

It is within this context that my research seeks to explore and solve some of sonification's issues and challenges. As a composer and researcher interested in the intersection of music and science, a novel methodology is necessary to answer questions which straddle more than one field of research. The interdisciplinary nature of my methods can render recognition difficult:

The fusion of tools from the arts with scientific methods has created the methodological innovation necessary to more fully address the complex realities that constitute social life. With this said, arts-based practices have a long way to go with respect to professional legitimacy so that academics are free to use these tools without cost to their career (from promotion to funding). (Leavy, 2015, p. 303)

The methodology of the project contributes to knowledge as much as the other outputs of the project – a portfolio and a thesis – as it provides a framework for working within musical and scientific disciplines.

1.2 Research Aims

The main aims of the project are:

1. To develop a framework for sonification as a compositional tool, that includes the definition of musification. The framework is intended for composers seeking to use data sonification for creative purposes, with a focus on the creation of electroacoustic music.
2. To create a portfolio of musifications with a range data from different scientific disciplines. A variety of datasets, musical languages, performance settings and

multimedia approaches are to be used in the composition of the research pieces. Best practice is to be explored for each of these combinations and approaches.

3. To develop an evaluation framework for musification, in terms of aesthetic perception and scientific understanding. Existing sonification practices, particularly in an artistic context, will be reviewed and evaluated to determine the gaps in knowledge and current shortcomings of the method. A novel evaluation method suited to musification is to be theorised and applied to the portfolio.

1.3 Research Questions

- What differentiates a musification from a sonification and what are its uses and characteristics?
- Which data and sound parameters can be used in musification? Well-understood musical parameters such as pitch, rhythm and harmony can strongly enhance the understanding of data when used in parameter mapping. But can musical parameters such as spatialisation and piece structure be mapped effectively?
- How can we evaluate the effectiveness of sonification in music from a scientific, musical, and a combined point of view? Which are the criteria that can determine a musification's functional and artistic qualities?

1.4 Research Methods and Strategies

1.4.1 Literature Review

A detailed literature review provides a theoretical framework for the compositional aspect of the research. Chapter 2 discusses the concepts of sonification, music, and musification; the challenges and opportunities in the practice of sonification are identified. Furthermore, the analysis of existing examples of sonification,

particularly in a musical context, serves to establish a hypothesis on possible approaches to a successful sonification.

1.4.2 Practice-as-Research

The experimental phase of the project uses a practice-as-research methodology to answer some of the research questions. Nelson (2006, p. 114) describes it as a ‘mixed mode research’ method which combines ‘practitioner knowledge’, ‘critical reflection’ and a ‘conceptual framework’. The three modes inform each other to generate knowledge (Fig. 1.3); my embodied knowledge and skills are applied and critically analysed within musical and sonification frameworks.

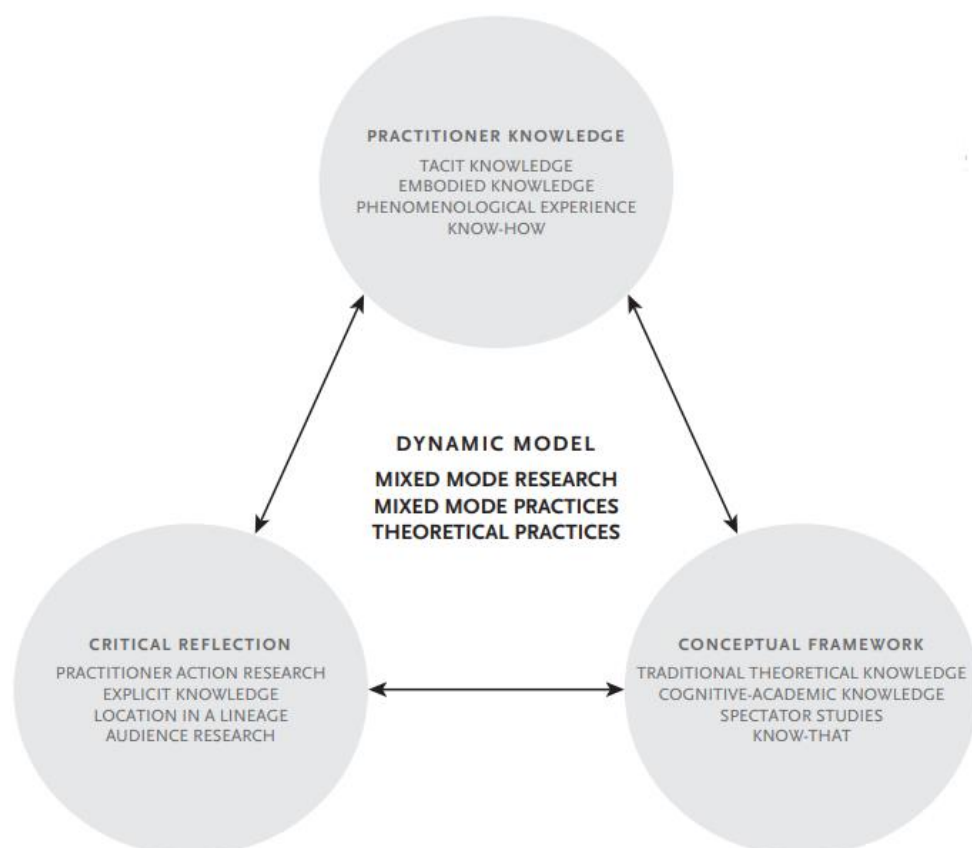

Fig. 1.3: A for mixed mode research showing the inter-relatedness of ‘practitioner knowledge’, ‘critical reflection’ and a ‘conceptual framework’ in practice-as-research (Nelson, 2006, p. 114).

The idea of practice-as-research is still emerging particularly for doctoral theses; however, it has many parallels to more traditional modes of research. Leavy (2014, pp. 3-4) claims that:

[...] art and science bear intrinsic similarities in their attempts to illuminate aspects of the human condition. Grounded in exploration, and representation, art and science work toward advancing human understanding. Although an artificial divide has historically separated our thinking about art and scientific inquiry, a serious investigation regarding the profound relationship between the arts and sciences is underway.

It is useful to consider the Organisation for Economic Cooperation and Development (OECD) definition of research: 'Creative work undertaken on a systematic basis in order to increase the stock of knowledge of humanity, culture and society, and the use of this stock of knowledge to devise new applications' (OECD, 2002, p. 30). The scientific method consists of observation, thinking 'about the observations and notice what appears to go together and what not', then making 'more observations, sometimes under the same conditions as before, but preferably choosing a situation in which conditions can be regulated precisely and planned experiments carried out' (Weatherall, 1968, p. 3). For a composer, research can be remarkably similar. Departing from a hypothesis (sonification can be a compositional tool) research questions are formulated (for example, which are the best data to sound mappings for a musical piece?); an evaluation of this practical work will lead the necessary knowledge to implement sonification as a compositional tool (or decide against it!).

The output of practice-as-research might not be 'text-based, but rather a performance (music, dance, drama), design, film, or exhibition'. This is because although it is a research method, it involves 'a significant focus on creative practice'; its output is often inherently performance-based (Arts and Humanities Research Board, 2003, p. 10). In the context of this project, the output is a thesis

and portfolio which describe and apply novel frameworks for the composition and evaluation of musification.

1.4.3 Software

The software used in this project was chosen for their suitability in the process. In this sense, the visual programming environment Max 7² was used for most of the data to sound mapping as it allowed easy input of data and mapping to synthesisers or sound files. For the piece *Blyth-Eastbourne-Wembury*, the sonification elements of the work were created in Max 7. For the *Sonification of Dark Matter*, Max 7 was used for image processing, colour tracking, and data to sound mapping. Finally, the piece *The Voice of the Sea* is entirely composed and performed with Max 7. The live data are fed into the programme and mapped to sound during the performance; visuals and live video is also handled in Max 7.

ProTools 10³ was used as a DAW to put together fixed media elements of the pieces. Specifically, the sonification element and other sound sources for *Blyth-Eastbourne-Wembury* were manipulated and turned into a composition in ProTools 10. Similarly, the software was used for *The Sonification of Dark Matter* to synchronise the visualisations and the various sound sources.

Finally, a 'pen and paper' approach was used for the instrumental piece *Waasgiischwashäsch*. The data were extracted from graphs to create relevant datasets with the help of the WebPlotDigitizer⁴. The score was edited and typeset in MuseScore 2⁵.

² cycling74.com

³ www.avid.com/pro-tools

⁴ <https://automeris.io/WebPlotDigitizer/>

⁵ musescore.org/

1.4.4 Evaluation

The evaluation of sonification and music are problematic. Sonification is often not evaluated statistically and its evaluation methods are not universally established (Ibrahim et al., 2001). Music relies on a set of aesthetic criteria which are ultimately subjective. How then, can we evaluate the quality of practice-as-research in music?

In an academic context, student compositions can be evaluated on subjective criteria such as presentation (handwriting, binding, etc.) and response to the brief (instrumentation, length, etc.). To a certain extent, we can evaluate whether this portfolio responds to the research questions but this does not necessarily give an indication of the intrinsic musical quality of it. The question is further complicated as music and sonification is combined: we must not only evaluate these elements separately but also how they work in combination.

The evaluation framework for the project must be novel because no existing one can appropriately be applied to the portfolio; this will be further discussed in 2.6 and Chapter 7. The framework will be developed on the basis of the findings during the project and then used to evaluate the pieces in the portfolio.

1.4.5 Between Methodologies

Practice-as-research combines creative practice and more traditional research methodologies. It is important to 'demonstrate that the use of an arts-based approach makes sense, for instance, garnering insights not otherwise available or as a means of distributing the research to relevant stakeholders' (Leavy, 2015, p. 268). I believe that this is indeed the case here, as a scientific method is applied to music composition. Practice-as-research research as a methodology brings its

own challenges as it is a 'hybrid form, and tensions can emerge as we try to balance research practice against artistic practice' (Leavy, 2011, p. 282). This is particularly clear when it comes to the evaluation of the work as no established framework exists; some might even question the need to evaluate artistic practice. Finally, Saldaña states that 'there is a tension between our ethical obligation to represent the data, to be truthful and faithful to the data, and our use of artistry in order to entertain as we educate and to produce quality art (Saldaña, 2011. In: Leavy, 2011, p. 282). The tension between truthful data and artistic license is a core challenge in sonification; it is at the basis of this project.

1.5 Thesis Overview

A survey of literature on sonification and its musical uses is presented in **Chapter 2**. The concepts of sonification, musification and music are defined and examples of practice are critically described. This review highlights gaps in the knowledge and creates a basis for exploration.

The chapters 3 to 6 discuss the individual pieces in the portfolio. Each chapter reveals findings on framework, contextualisation and concepts. Findings from a chapter are applied to the next piece, therefore the approach in the portfolio and the thesis can be considered incremental.

Chapter 3 discusses a piece for fixed media using sea temperature and salinity data sonification, *Blyth-Eastbourne-Wembury*. The analysis of the compositional process produces a framework for sonification as a compositional tool which is applied to the next pieces.

Chapter 4 discusses the piece *The Sonification of Dark Matter* which uses dark matter data extracted from a visualisation of the original dataset. The concepts of

'collaboration' and 'scientist-composer' are discussed. A short survey of shared working relationships demonstrates the difficulties in working collaboratively, while the concept of the 'scientist-composer' offers new creative possibilities for the individual composer.

Chapter 5 looks at a piece using buoy data sonification with live electronics. *The Voice of the Sea* is contextualised in the tradition of musical representation of nature. We show that sonification can be used as a form of Augmented Reality to create an immersive listening experience.

Chapter 6 describes the orchestral piece *Wasgiischwashäsch* which uses Rossini's *William Tell Overture* and modifies the original musical parameters according to Swiss climate change data. The use of musical borrowing in sonification is proposed to create more effective and accessible sonification. The process of sonification is contextualised in relation to the Shannon-Weaver Model of Communication. The concept of orchestral sonification is introduced to discuss the affordances of aural display using acoustic instruments.

Chapter 7 discusses methods of evaluation for sonification and music, before proposing a framework for the evaluation of musification.

Chapter 8 concludes the thesis; it revisits the research aims and questions and highlights the contributions to knowledge. Finally, recommendations for future work are presented.

Chapter 2

From Sonification to Musification

2.1 Sonification

Sonification is defined as ‘the use of non-speech audio to convey information’ (Kramer et al., 1999); it makes data audible. It can be a powerful method of translating data for human understanding, and a tool for ‘facilitating communication or interpretation’ of data (Kramer et al., 1999).

The term sonification is an umbrella term for a plethora of different techniques applied to a variety of data. In fact, it is a process: ‘the direct linkage process between the data itself and some technique for rendering it in a sound space’ (Gresham-Lancaster, 2012, p. 210). A classification for the types of sonification is proposed by Hermann and Ritter: Audification, Parameter-mapping Sonification, Auditory icons (including Earcons), and Model-based Sonification (Hermann and Ritter, 2004, pp. 734-35).

2.1.1 Audification

Audification is a process where numerical data become an audio waveform as they are mapped to sound pressure levels. The audification of EEG is a useful example; brain wave frequencies can be made audible fairly simply (Wu et al., 2009). The process involves compressing the duration and amplitude of the original waves, scaling them to the human hearing range (Abenavoli, 2012, p. 278).

Audification can be emotionally powerful because it provides a direct translation of data to audio; the listener has a direct physical experience of a physical phenomenon. This method has, however, obvious limitations as it 'is only applicable for limited sorts of data sets and requires many data points to deliver reasonably long sounds' (Hermann and Ritter, 2004, p. 734).

2.1.2 Parameter Mapping Sonification (PMSon)

The most commonly used method of sonification is *Parameter Mapping Sonification* (PMSon):

Parameter mapping sonifications are generated by superimposing data-driven sound events, e.g., instrument sounds, according to given parameters like onset time, duration, pitch, and amplitude. Each data point now is mapped into the parameters of a separate sound event, which gives the method its name and offers much more flexibility than audification, since both the underlying instrument sounds as well as the data-to-parameter mapping can be specified by the designer of the sonification according to the special needs of the data analysis task at hand. (Hermann and Ritter, 2004, p. 734)

As Hermann and Ritter point out, PMSon offers flexibility in designing the sonification as the mappings are chosen to suit the dataset. The near infinite possible combinations of data to sound mappings represent a challenge in themselves as there 'is a very large set of possible mappings but a notoriously small subset of perceptually cognitively, valid mappings' (Roddy and Furlong, 2014, p. 70). Although there are only a limited set of effective mappings, the potentially unlimited number of mappings available means that they need to be carefully defined for each dataset.

A further challenge of PMSon is the potential lack of emotional or cognitive relation between the data and their sound mappings, if they are arbitrarily assigned. One intuitively feels that medical images, for example, ought to somehow sound different from demographic data or satellite imagery (Smith, 1990). Problematically, we could produce two near identical sonifications from

different datasets. This issue is visualised by the group of datasets called *Anscombe's Quartet* (Anscombe, 1973, pp. 19-20): it consists of four different datasets with eleven data points each, with nearly identical statistical properties (Fig. 2.1 and Table 2.1). It demonstrates the need for careful data handling and mapping in the sonification process to transmit useful data parameters.

An (intentionally) unsuccessful sonification design demonstrates the issue of arbitrary data to sound mapping in PMSon; the Euler number and the metric tonnes of salmon sold in the second quarter of 2010 on the London Stock Exchange are mapped to the same range of pitches⁶ (Angliss, 2011). The resulting sonification sound similar melodically and are equally irritating musically; because of the relative randomness of the datasets, this particular sonification has no recognisable musical structure. As a conclusion, the design of PMSon involves considerate data handling and mapping if it is to be effective; these are compositional processes which will inform the sound production process.

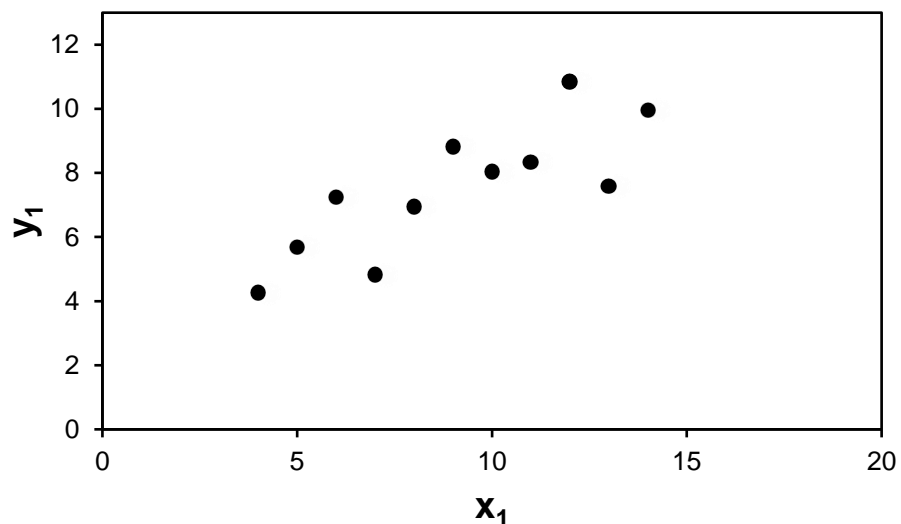

⁶ <http://madartlab.com/eulernumberfish/>

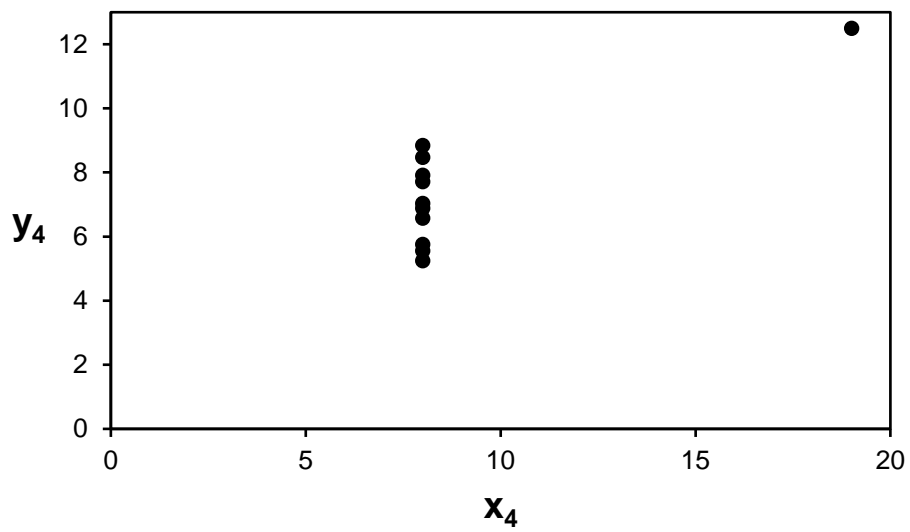
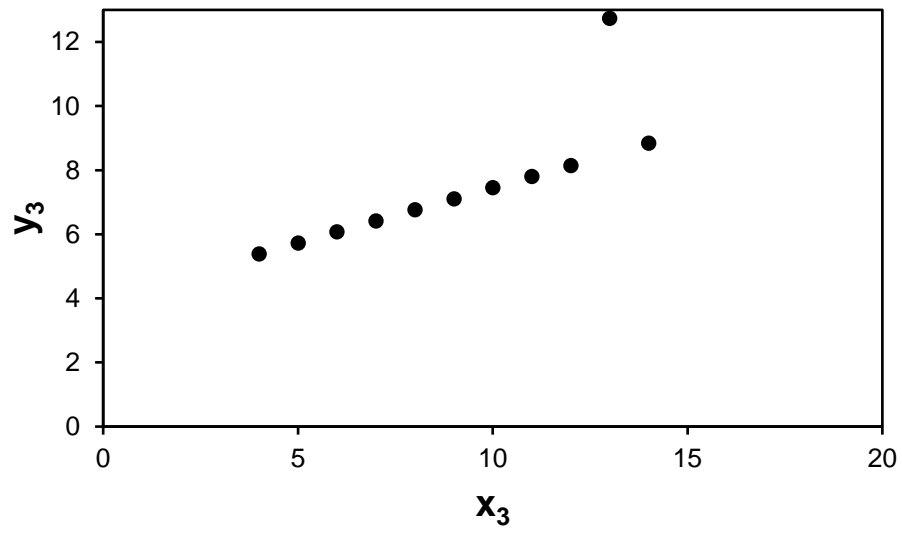
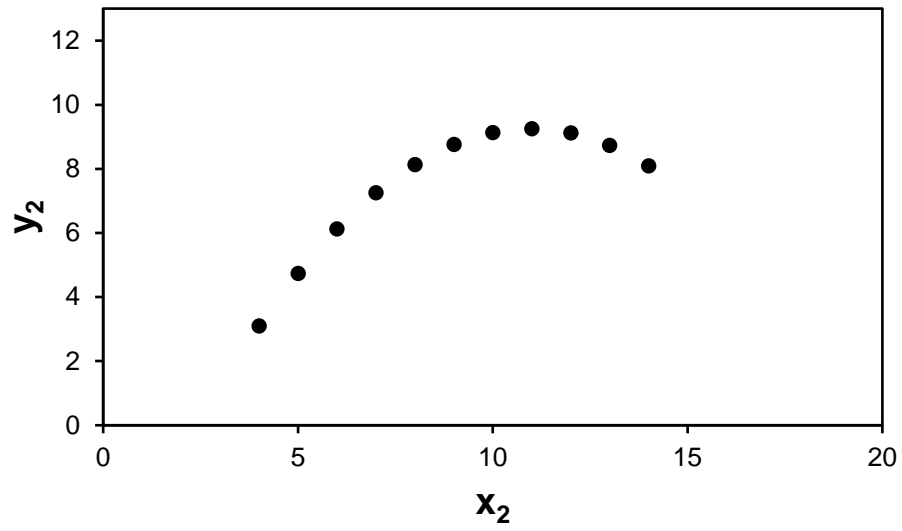

Fig. 2.1: Anscombe's Quartet datasets plotted on x-y axis.

Tab. 2.1 Anscombe's Quartet's statistical properties and their values, these are nearly identical for the four datasets.

Property	Value
Mean of x	9
Sample variance of x	11
Mean of y	7.50
Sample variance of y	4.125
Correlation between x and y	0.816
Linear regression line	$y = 3.00 + 0.500x$
Coefficient of determination of the linear regression	0.67

2.1.3 Auditory Icons

Auditory Icons can be understood as aural metaphors: the sound that is heard represents the event that it informs the listener of. The sound of the 'Recycle Bin' in Windows signals that a document has been deleted through the sound of paper being thrown in a bin. Auditory icons are easier to understand because of the metaphorical link between data and sound, which does not need to be learnt. They 'provide an intuitive linkage' (Brazil and Fernström, 2011, p. 325) between the world represented and the sound heard; they require 'an existing relationship between the sound and its meaning' (McGookin and Brewster, 2011, p. 339). Where such relationship does not already exist, the aural metaphor can be provided by *Earcons*. These are defined as 'non-verbal audio messages used in the user-computer interface to provide information to the user [...]'. Earcons are 'the aural counterpart of icons' (Blattner et al., 1989, p. 13) as there is no

assumption of prior knowledge about the metaphor. The relationship between information and sound needs to be learnt by the user.

Auditory icons and Earcons have specific applications but some of their design aspects can inform solutions to challenges posed by PMSon. Aural metaphors create a natural connection between the data and the sound. Because the Earcon does not have an obvious connection between the subject matter and the sound though, its design must be particularly effective in order to transmit information. They should be 'systematic', 'straightforward to understand and use', transformable, grouped into families, and easy to implement computationally (Blattner et al., pp. 22-23). By 'grouped into families', we mean that similar events should sound similar, thus relating back to the idea of an aural metaphor. This approach to creating a natural connection between unrelated data and sound is beneficial to PMSon design too. Interestingly, Blattner et al. call for an 'expert in sound relationships in the design team', ideally a 'professional composer, preferably with some experience in electronic (synthesized) music' (Blattner et al., 1989, p. 23). They therefore acknowledge the importance of careful aesthetic considerations in sonification design, an idea which will be further explored in this chapter.

2.1.4 Model-based Sonification (MBS)

Model-based sonification (MBS) is conceptually different from the approaches described above. The technique uses an acoustic model which produces a response when excited, so it consists of a 'virtual sound-capable system' with a set of instruction for interaction; its 'acoustic response, or sonification, is directly linked to the temporal evolution of the model' (Hermann, 2011, p. 399). This method is particularly useful for the analysis of data with no time dimension

(Hermann, 2011, p. 421); the model used for sonification is also simple to modify for multiple uses, whereas all parameters for PMSon need to be specified for every sonification (Hermann, 2011, p. 423-24). This method largely remains to be explored but examples where MBS could be used include data crystallisation, growing neural gas and particle trajectories (Hermann, 2011, pp. 411-14).

2.1.5 Further Techniques

A number of authors subdivide the field of sonification slightly differently. However, the categories always resemble the organisation proposed above. For example, Barrass proposes the following techniques: Sinification, MIDIfication, Musicification [sic], Vocalization, Iconification, Stream-based. Sinification means mapping data to sine-tones, MIDIfication uses MIDI notes for this purpose. Musicification [sic] uses musical scales and chords, and vocalization uses synthesised vowel sounds. Finally, Iconification uses 'metaphorical connotations' and stream-based sonification uses granular synthesis (Barrass, 2012, p. 180; Barrass, 2003). Effectively, all these techniques are PMSon; they only differ in their sound source. Iconification could also be classed as an auditory icons technique, depending on its use and design.

2.2 Towards a Definition

Kramer et al.'s definition of sonification - 'the use of nonspeech audio to convey information' (Kramer et al., 1999) - is the most popular in literature, possibly because it is concise and easy to understand; other authors have further refined the definition. Hermann (2008, p. 2) states that the term sonification is applicable if and only if,

(C1) The sound reflects *objective* properties or relations in the input data.

(C2) The transformation is *systematic*. This means there is a precise definition provided of how the data (and optional interaction) cause the sound to change.

(C3) The sonification is *reproducible*: given the same data and identical interactions (or triggers) the resulting sound has to be structurally identical.

(C4) The system can intentionally be used with *different data*, and also be used in repetition with the same data.

These conditions are particularly useful in the evaluation of a sonification, as they provide a framework for determining what constitutes a sonification. In music, quantitative evaluation is rare and difficult; qualitative evaluation is the norm but is far more difficult to describe. The parallels between sonification and music are apparent in Walker and Nees' definition: sonification 'seeks to translate relationships in data or information into sound(s) that exploit auditory perceptual abilities of human beings such that the data relationships are comprehensible' (Walker and Nees, 2011, p. 9). Music translates some relationships in the physical world to organised sound, to become comprehensible to human beings (the relationships include but are not limited to data).

Scaletti proposes the following definition: 'a mapping of numerically represented relations in some domain under study to relations in an acoustic domain for the purpose of interpreting, understanding, or communication relations in the domain under study' (Scaletti, 1994). Rather than *information*, Scaletti talks about *numerically represented relations*, which highlights the fact that information is data which have been provided with context (Barrass, 1997, p. 29-30). Furthermore, she describes the information transmission process as the *interpreting, understanding and communicating* of information. These three separate processes which encapsulate information transmission divide the latter into separate processes. To focus on one of the processes rather than all three

might be more effective in some applications. In sum, Scaletti's definition describes the different functions of the information transmission process and recognises that they might need different representation in the aural domain. Barrass condenses her definition as follows: 'the design of sounds to support an information processing activity' (Barrass, 1997, p. 30).

2.2.1 Auditory Display

The term sonification encompasses a number of techniques but is itself a subset of auditory display. The boundaries between the terms are not always clear (Walker and Nees, 2011, p. 12), but Hermann's conditions are a helpful step towards this distinction. Hermann et al. state that 'Auditory Display encompasses all aspects of a human-machine interaction system, [...] necessary to obtain sound in response to the data' (Hermann et al., 2001, p. 1). They distinguish sonification as 'a core component of an auditory display: the *technique* of rendering sound in response to data and interactions' (Hermann et al., 2001, p. 1).

We have not yet discussed the concept of 'non-speech sound' in Walker et al.'s definition of sonification. Sounds which have a semantic meaning (for example, speech) present a whole new set of affordances and challenges, even when the sounds are synthesised. Auditory icons are an area of sonification where it is simple to imagine that speech sounds could be useful as they are intrinsically related to the task that the user is performing. Speech-related sounds will not be considered as their affordances are beyond the scope of this project. Walker and Nees conclude that 'ultimately, the name assigned to a sonification is much less important than its ability to communicate the intended information' (Walker and Nees, 2011, p. 12).

2.2.2 Functional Sounds

The above discussion on sonification as a subset as auditory display highlights that sonification serves a function, to transmit information. Hermann's systemic map of sound (Fig. 2.2) positions sonification as a subset of functional sounds (Hermann, 2008, p. 5). These in turn are part of the larger set of organised sound; of which music and media arts are another subset. Interestingly, Hermann recognises a possible overlap between music and media arts with functional sounds and sonification. An example of a sound that can be both musical and functional is the post horn. It was used during the 18th and 19th century to signal the departure of a mail coach. It has, however, also been used as an instrument by Wolfgang Amadeus Mozart in his Serenade No. 9; Franz Schubert's song *Die Post* from the *Winterreise* features a horn signal motive rather than the actual instrument.

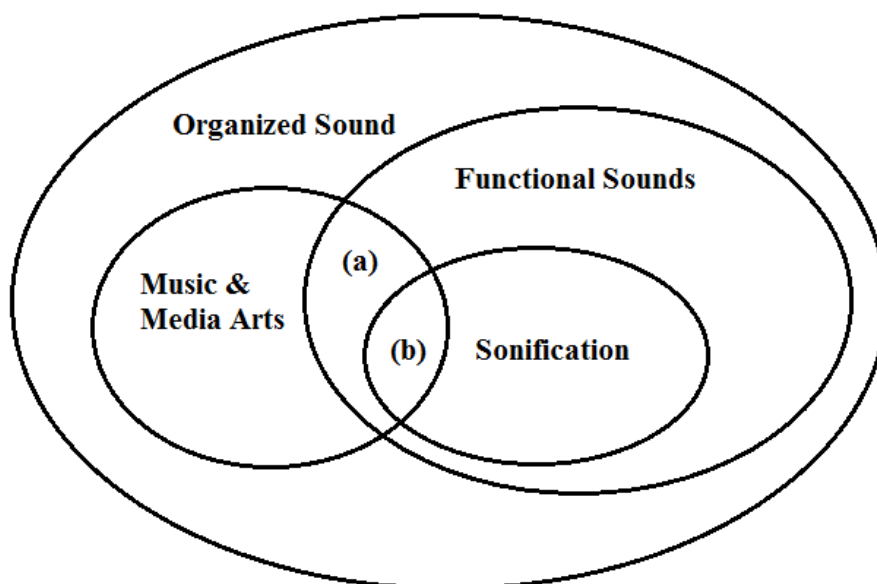

Fig. 2.2: Hermann's systemic map of sound (Hermann, 2008, p. 5).

The systemic map of sound describes as a mostly functional method with some applications in music and media arts. Conversely, purely functional sonification contains an element of music, or at least aesthetics.

2.3 Aesthetics

2.3.1 Aesthetics in Sonification

Sonification is interdisciplinary by nature, 'integrating concepts from human perception, acoustics, design, the arts, and engineering' (Walker and Kramer, 2004, p. 7). It combines the science underlying the sonified data with psychoacoustics and human perception to transmit information. This knowledge can be provided by scientists and sound designers respectively. Their combination informs aesthetical considerations for sonification design.

A number of researchers have called for collaboration with composers or experts in sound (Walker and Kramer, 2004; Blattner et al., 1989; Kramer, 1994a; Vickers and Hogg, 2006; Barrass and Vickers, 2011). Aesthetic attributes play a major role in the acceptance of sonification by listeners: pleasantness, loudness, noticeability, clarity, integration. The composer's role in sonification is analogous to the artist's role in data visualisation, as 'improved aesthetics will likely reduce display fatigue' (Kramer, 1994a, p. 53). A study of the soundscape of a hospital ward describes it as an example of a sonified environment that demands quick and precise information transmission during prolonged listening. The audio signal (for example from a heart rate monitor) should be precise to describe the nature of the emergency. It should be clearly discernible in a sonically dense environment, without being irritating during prolonged listening. Finally, it should be correlated to the nature of the emergency (Sinclair, 2012). It is clear that even

in the context of sonifications which are purely functional, some degree of musical knowledge or sensibility is crucial.

2.3.2 Aesthetics and Beauty

The mathematician Paul Dirac proposed the idea of beauty in mathematics as the *Principle of Mathematical Beauty* (Dirac, 1939). He believed that one should strive for mathematical beauty in science, rather than simplicity, although both are often synonymous. Where they are not, beauty should take precedence. This is not for the sake of beauty, but because the 'simple, that is, the beautiful, brings understanding more readily' (Barrass and Vickers, 2011, p. 158). In the context of sonification, the idea of beauty in Nature supports the claim that aesthetics are important in designing auditory displays; this is not for the sake of beauty but to increase the acceptance and thus effectiveness of the auditory display. We can again conclude that sound designers can play an important role in doing so.

We must note at this point that aesthetics is not necessarily synonymous with beauty as something pleasant. The broader Greek root for the word refers to the perception by the senses. In that sense an aesthetic object is that which 'appeals to the senses in a certain way (Rose-Coutré, 2007, p. 5). Numerous examples can be given for pieces of music which might not be conventionally appealing, such as noise or glitch music, but have a specific aesthetic. However, in the context of sonification we must remember that it is not, in a first instance, about art or music:

Aesthetics is about more than art, at its core it is about sensuous perception – we make aesthetic judgements every day about the products we buy (or don't buy), the clothes we wear, and the tools we use. (Barrass and Vickers, 2011, p. 158)

We have described the aesthetics of a sonified environment like a hospital ward above; while most of the output will need to be fairly pleasant to avoid auditory

fatigue, some of it will need to be in some way disturbing in order to raise alarm. Ultimately, the aesthetics are subordinate to the function of the sonification.

2.3.3 Psychoacoustics and Human Perception

Psychoacoustics and human perception are crucial for the aesthetics of sonification design. Arguably, one of the most successful sonifications is the Geiger counter (Taylor, 2017). It sonifies the level of radiation through the frequency of clicks; Taylor argues that it taps into on ‘instincts shared by humans and primates’. The curve of acceleration and intensity is understood to signify danger. Interestingly, it is also found in music: the Mannheim rocket, for example, consists of a rapid arpeggiated chord with a crescendo. It is also important to understand how sound parameters are perceived, and which can be most appropriate to a specific task. Pitch and Rhythm are the most used sound parameters in sonification because they are easy to manipulate and even small changes can be heard. Further issues in perception which composers should consider include ‘absolute detection thresholds, discrimination sensitivities, and masking’ (Walker and Kramer, 2004). Although anyone working with sound will more or less consider these issues, a conscious awareness of them is important in order to effectively complete tasks relating to auditory display and cognition.

Auditory perception and understanding often overlap with cultural connotations. For example, is the perception of dissonances innate or culturally transmitted? There are physiological reasons to perceive certain intervals or chords as dissonant, although opinions diverge on the specific phenomenon. A popular theory is that the ‘beating’ caused by close partials ‘that stimulate the same region of the basilar membrane in the cochlea’ are perceived as roughness (Johnson-Laird et al., 2012). Another theory is that it is rather the inharmonic spectrum of a

dissonance that causes a feeling of roughness, rather than the beating (Cousineau, et al. 2012). Regardless of the physiological response to dissonance, there are also culturally transmitted connotations to this roughness, as demonstrated by the use of differing tuning systems in different cultures. Dissonances are paramount in Western Classical harmony, as they prepare a resolution and the consonant return to the tonic. It is thus likely that our perception to dissonance, for example, is determined by both physiological and cultural factors.

A commonly understood musical language can be harnessed to facilitate information transmission; yet, a possible criticism of the use of musical aesthetics in sonification is that adds an additional language level to the auditory display, which could interfere with the understanding of the data (Vickers and Hogg, 2006, p. 212). However, this argument does not consider that the listener needs to know the language or framework of the sonification in order to understand it. Even untrained listeners understand basic musical grammar; harnessing this commonly understood language can facilitate the comprehension of a sonification. Connotations such as major and minor modes being 'happy' or 'sad' can be a simple way of attributing meaning to sound. Therefore, the use of any musical language needs to be carefully considered and applied in the most effective manner.

Vickers and Hogg propose an aesthetic framework which describes the 'Ars Informatica-Ars Musica Continuum' (Vickers and Hogg, 2006, p. 214). The framework combines two continuums: from abstract to concrete (indexicality) and from Ars Informatica (sonification) to Ars Musica (music and sound art) (Fig. 2.3). The resulting graph contains four categories: Musique Abstraite, Musique

Concrète, Sonification Abstraite and Sonification Concrète. The *indexicality* spectrum defines how much an aural display sounds like the information or idea it is derived from. So, the concrete sonification sounds most like the data it is derived from. While this framework does not serve as qualitative evaluation of a sonification, it is a useful tool to describe it.

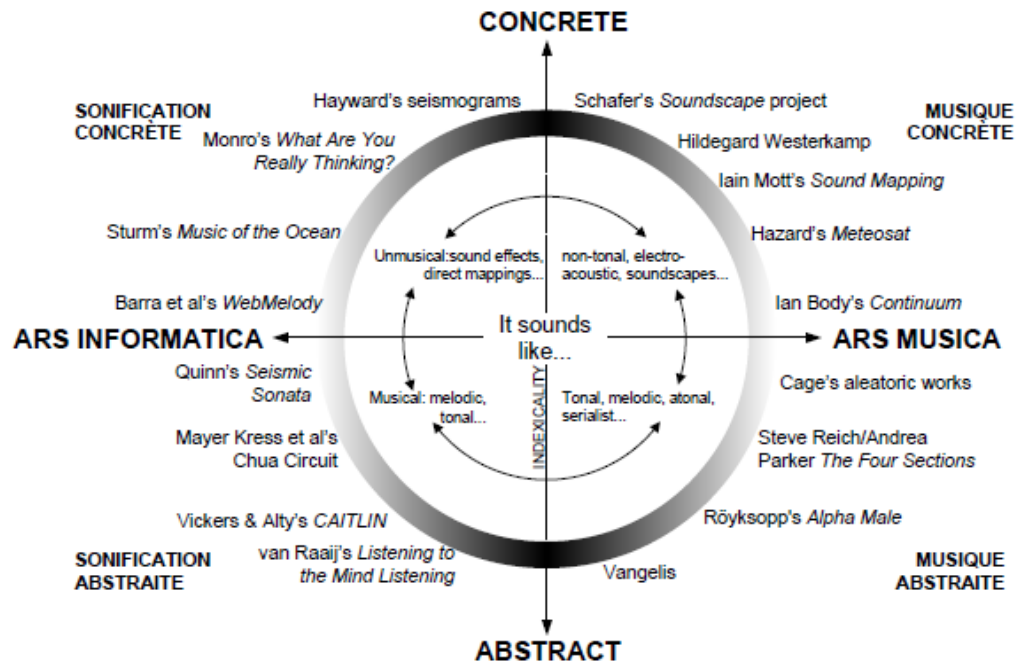

Fig. 2.3: The Ars Informatica-Ars Musica Aesthetic Perspective (Vickers and Hogg, 2006, p. 214).

2.4 Sonification and Music

2.4.1 ICAD

The functions of sonification are commonly described as 'alerting functions', 'status and progress indicating functions', 'data exploration functions', and 'art and entertainment' (Walker and Nees, 2011, p. 12; Kramer, 1994a; Walker and Kramer, 2004). Art and Entertainment has featured consistently in the

International Community for Auditory Display's⁷ (ICAD) activities, but has struggled to find real acceptance with its members. Supper argues that sonification's rapidly increasing popularity in popular science undermines efforts to establish as a serious scientific method. By describing sound as potentially more emotional to the audience, we are also reinforcing the idea that vision is more suited to rational scientific endeavours (Supper, 2014, p. 52). The 2002 edition of ICAD's conference auditory display first called for art submissions, and Lulu Ong and Damien Lock's work *Acoustic Acclimation* was chosen (Barrass and Vickers, 2011, p. 149-50).

2.4.2 Popularity

The popularity of sonification in popular science and its struggle to find acceptance can be traced on the Hype Cycle (see Fig. 1.2). The potential applications of sonification have been recognised. Yet, 'perhaps because of the novelty value in the early days of being able go "ping" many sonifications (including recent ones) have been created that are not particularly useful, useable, or meaningful' (Barrass and Vickers, 2011, p. 154). In fact, once the novelty factor of sonification has worn off, we find that many are lacking aesthetically or scientifically. The danger of sensationalism and gimmickry is unfortunately omnipresent (Taylor, 2017). Once the Hype Cycle's 'Trough of Disillusionment' has been reached, sonification researchers must aim to develop the 'killer application' which would convince the scientific and musical communities of its worthiness (Supper, 2012a, p. 101).

⁷ icad.org

2.4.3 Further Criticisms

We have discussed a number of reasons for the lack of acceptance of sonification. A particularly critical view of sonification decries the ‘conversion hysteria’ that accompanies the method: the obsession with converting anything to sound, even where there is no ‘sound of’ something (Connor, 2013, p. 10). Connor concludes sonification’s ‘nonutility’, as information is rarely effectively transmitted. Sonification has even been described as ‘mystical’: seeking to understand data that ‘are incomprehensible through traditional analytic means and can only be understood through experience’ (Wolfe, 2014, p. 304). Wolfe argues that the ear is an ‘unreliable witness’ as the ‘experience of sound is demonstrably subjective’ (Wolfe, 2014, p. 305). Therefore, the sonification experience is close to the mystical experience, as we experience the information rather than process it with reason. While both opinions reflect a number of issues raised during the review, I find their conclusions problematic. They both recognise a degree of subjectivity in sonification, be it through the process itself or the physiological aspects of hearing. Connor also decries the ‘hysteria’ in attempting to sonify all types of data, and by any means. Rather than concluding that sonification is useless and mystical, I would argue for an increased awareness of these issues; a solid evaluation framework should be able to take them into account.

2.5 Music

To define the term of musification, we must be clear on what we mean by the concept of music. The Oxford English Dictionary (OED) defines music as ‘vocal or instrumental sounds (or both) combined in such a way as to produce beauty of form, harmony, and expression of emotion’ (Allen, R.E., 1992, p. 781). This definition can rapidly be proven to be reductive and inappropriate in describing a

number of musical genres. First, it does not define what constitutes an instrumental sound; for example, can a laptop be considered a musical instrument when used to produce sounds? The second part of the OED definition is problematic too, as music does not necessarily present a 'beauty of form, harmony, and expression of emotion'. While the concept of beauty is ultimately subjective, music genres such as noise music almost implicitly move away from such ideas. A wider definition of music is needed to describe the variety of creative outputs considered as musical.

Rather than asking what music is, we can also ask what elements constitute music. Milton Babbitt describes music as a 'five-dimensional space' containing the following dimensions: Pitch-class, register, dynamic, duration and timbre (Babbitt, 1958, p. 39). These are effectively mirrored in Scruton's list: Pitch, Rhythm, Melody, Harmony and Tone colour (Scruton, 1997, p. 20). Scruton also offers the view that tonality is what determines musical form (Scruton, 1997, p. 234); this is particularly applicable in the sonata form, for example, where harmonic tensions build in the development before resolving in the recapitulation. Copland includes Rhythm, Melody, Harmony and Timbre. More interestingly, Copland claims that music shall have 'an expressive quality which arouses an emotional response in the listener' (Copland, 1939, pp. 40).

Scruton considers music to be a 'special kind of sound' (Scruton, 1997, p. 16). Organisation in the sound does not constitute music necessarily; the same definition could be applied to poetry for instance. He also warns against thinking of aesthetic sound as music; a water fountain can produce a pleasing sound but would be considered as sound art, at most. Scruton believes that music results from a *sophisticated universalism* which means that music is a high art of sound.

There must be a purposeful decision to transform tones into this high art. Consequently, music is absolute; it does not in itself transmit information (Scruton, 1997, p. 172). Even if the composer has intended to transmit a system in a piece, the listener will not necessarily hear it. Therefore, it might therefore be entirely pointless to use any such systems in composition (Scruton, 1997, p. 212).

Scruton's position on music's sophisticated universalism and absolutism is opposed to John Cage's concept of music. The latter sees no difference between music and ambient sound; any sound could be music (Hamilton, 2007, p. 46). Cage's position owes to Varèse's much-cited definition of music as 'organized sound' (Varèse, 1940). Varèse finds previous definitions of music too restrictive; with his definition avoids defining music with regards to his own work (Landy, 2007, p. 5). The idea of music as organised sound implies a willingness to hear certain sounds as music; Maconie says that 'for sound to be perceived as music is an act of individual determination' (Maconie, 1990, pp. 11-12; In: Hamilton, 2005, p. 46). Cage's 'silent' piece 4'33" is an extreme application of Varèse's definition. The piece demonstrates that even when the performer is silent (only an indication of *Tacet*), music is produced by the ambient sounds of the performance space. Frequently misunderstood, this piece is a literal demonstration of the idea that any sound can be music. However, the individual determination of sounds as music can also be found in classical music. Mahler's Sixth Symphony, for example, uses a hammer as a percussion instrument; the thud of the hammer (functional sound) becomes a percussive sound.

The implication of defining music as an act of individual determination is that the definition of music must be different for each individual. Nattiez (1990, pp. 47-48) explains:

[...] just as music is whatever people choose to recognize as such, noise is whatever is recognized as disturbing, unpleasant or both. The border between music and noise is always culturally defined – which implies that, even within a single society, this border does not always pass through the same place; in short there is rarely a consensus.

If it is difficult to give a definitive definition of music, particularly in different cultural contexts, it is even more difficult to determine what music transmits to the listener. The question of meaning in music gains importance when discussing musification, where the music is intended to transmit information and provoke an emotional response from the listener. The debate dating from the 19th-century which opposes *absolute music* and *programme music* highlights issues of the meaning of music and meaning in music. First used by German Romantic writers and then Hanslick, absolute music is 'pure, objective and self-contained' (Hamilton, 2007, p. 67). It is music for music's sake and art for art's sake. Absolute music functions divorced from any subordinating elements such as words, stories or feelings. Hamilton describes it as 'a metaphysical aspiration, and not a social fact; [...]' which presents a model of what [the composers] are trying to achieve' (Hamilton, 2007, p. 68). In practice, it is impossible for music to exist in complete isolation. Programme music on the other hand, has an extra-musical programme; composers such as Liszt and Strauss wrote symphonic or tone poems which painted a picture in sound. Liszt wrote explanatory prefaces for his tone poems with evocative titles such as *Hunnenschlacht* (Battle of the Huns, 1857) and *Festklänge* (Festive Sounds, 1853). The romantic composers' intention was to ensure that the listener understood the emotional complexities of the piece (Copland, 1939, p. 168). Innumerable examples of this practice, whether labelled as such or not, can be found in music history. While the opposition of absolute music and programme music is symptomatic of the end of Romanticism in 1840's Germany (Hamilton, 2009, p. 69), it is nevertheless a useful aesthetic debate when positioning music and musification on the absolute-programmatic spectrum.

Finally, we must discuss the idea that music is some universal language of emotions. A musical style is 'based on the consensual experience of a whole culture' (Loy, 1991, p. 30), it is therefore far from universal. Rothenberg dismisses the idea of music as a universal language because a language must be learned, whereas music can move anyone who has not learnt the language of music. Therefore music is only 'part of a language', the understanding of which allows you to grasp its rules. On one hand then, music cannot be completely understood nor described. On the other hand, some people will be moved by music and others not, some will understand it and others not. It is therefore not a universal language (Rothenberg, 2011, p. 1). We must therefore consider music as a commonly understood language rather than a universal one. When composing, we must work with the assumption that our listeners will understand a certain musical style; but we are aware that not everything will be grasped, and that is the nature of composition.

In the context of this thesis, the definition of music shall be borrowed from Varèse and Maconie: organised sound which has been determined to be musical. Additionally, Hermann's systemic map of sound is subscribed to, where music is a subset of organised sound but *can* also at the same time be a subset of functional sounds (Hermann, 2008).

2.6 Musification

Musification is a concept derived from sonification. Two approaches are commonly found to describe it. First, musification is a sonification with musical constraints; imagine a data mapping to pitches on a discrete musical scale rather than continuous frequencies. It could therefore be a purely functional sonification which however follows musical principles to aid the understanding of the data, for

example by sounding in major or minor mode in relation to positive or negative information (as found, for example, in Williams, 2016).

The second approach is to consider musification as a sonification for artistic purposes (Grond and Berger, 2011). There is therefore an act of determination, where a sonification is ascribed artistic qualities.

The approach taken for this project combines both definitions. Musification is a sonification which follows some sort of musical constraints while also existing as a piece of music. The idea of musification for purely functional purposes (Williams, 2016) will not be explored; it falls outside the scope of the project. As musification is a subset of sonification, it should transmit information to the listener as well as existing as a self-contained piece of music. We have seen that music cannot be divorced from its environment; musification in particular is bound to its originating data. The composer could choose not to show the underlying process (sonification) in the musification, but it is this process that differentiates it from a piece of organised sound. Barrass and Vickers (2011, p. 146) discuss the issue:

Generally, the composer is concerned with the musical experience, rather than the revelation of compositional materials. However, when the data or algorithm is made explicit it raises the question of whether some aspect of the phenomenon can be understood by listening to the piece. When the intention of the composer shifts to the revelation of the phenomenon, the work crosses into the realm of sonification.

As with music, there is a degree of individual determination in creating and labelling a musification.

Musification is the result of a number of processes. Data are the starting point for sonification, but data without context are only data. Only coupled with context do data become information (Roddy and Furlong, 2014, p. 75). Therefore, sonification is only sound until it has a context. If music is organised sound then, a musification is an organised sonification (Bonet et al., 2016). This sonification

is organised in a manner that transmits information within it's a context while producing musical structures.

A musification exists on functional-artistic spectrum (Fig. 2.4); this describes the performance context and intended use of the display. It is comparable to the spectrum from *Ars Informatica* to *Ars Musica*, except it describes the intention of the aural display rather than labelling it as sonification or music. In the context of this project, musification should be in the central area of the spectrum, where it incorporates both ends of the spectrum: to inform and entertain.

However, this spectrum does not inform us about the quality of the musification. The field lacks guidelines on design and evaluation (Ibrahim et al., 2001) and this issue is even more marked for the field of musification. A new framework is needed to evaluate musification; this will be discussed in more detail in Chapter 7. A preliminary evaluation chart could ask two questions: (a) how effective is the musification as an auditory display? (b) how musically accomplished is the musification (Fig. 2.5)? The combined score determines 1) whether the auditory display is a musification 2) the quality of the musification from an artistic and functional point of view. The criteria for (a) and (b) must be further explored and established but this initial chart is a basic framework for experimentation. The sonifications produced during the project should fall within the dotted square on figure 2.5, as this signifies that they combine sufficient functional and artistic purpose. Even if it scores a bit lower on either question, there is a guarantee that it nevertheless scores highly enough on both axis to be considered a musification.

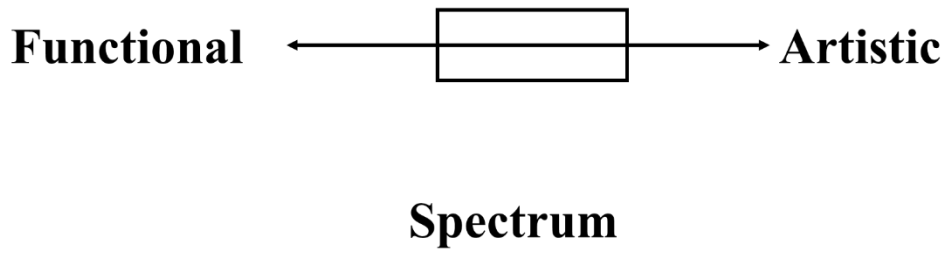

Fig. 2.4: Functional-Artistic Spectrum of musification.

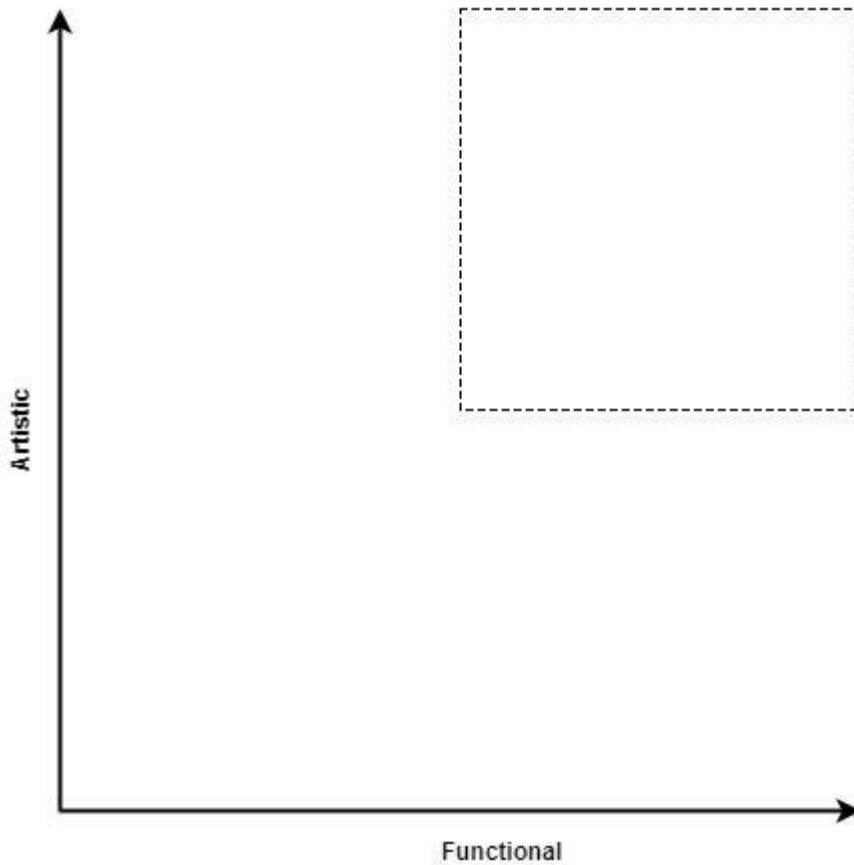

Fig. 2.5: Evaluation chart for musification. (Functional) how effective is the musification as an auditory display? (Artistic) how musically accomplished is the musification? The dotted square is the area signifying a high quality musification.

2.7 Trends in Musification

An overview of existing musifications shows a variety of approaches by composers to the challenge of listening to data as music. A variety of examples along the functional artistic spectrum are presented; they are chosen according

to their relevance to research questions and the research portfolio. They are grouped by data source, with a focus on data types used for composition, and examples which reveal important issues around musification.

2.7.1 Natural Organisms

Some of the earlier examples of sonification are of DNA and protein sonification. DNA chains consist of very large patterns of amino acids⁸; auditory display can be better suited for exploring these multivariate data because multiple notes can be heard simultaneously (King and Angus, 1996, p. 251). In 1984, researchers proposed that DNA sequences should be transferred to computer by sound rather than through keyboards, because the typing of sequences of 'lengthy and apparently meaningless successions of often thousands of the characters A, T, G and C is tedious and boring (Hayashi and Munakata, 1984, p. 96). The sonification of amino-acid sequences has been explored as an approach for the general public, children and visually impaired users (Takahashi and Miller, 2007). Although boring to type, the simple and repetitive nature of the strings of A (adenine), T (thymine), G (guanine) and C (cystosine) make DNA sequences simple datasets to sonify. Ohno and Ohno describe the DNA's innate musicality as both genome coding sequences and music rely on 'repetitious recurrence' (Ohno and Ohno, 1986, p. 71). They also claim that because palindromes are often found in proteins, the musical result from sonifying proteins can produce the beauty of musical palindromes (Ohno, 1993).

⁸ Codons are sequences of three DNA nucleotides and they correspond to specific amino acids and stop signals in protein synthesis. Proteins consist of twenty different amino acids.

Generally, parameter-mapping sonification has been used for proteins and DNA, for instance by assigning absolute pitches to each of the four DNA nucleotides (Dunn and Clark, 1999; Takahashi and Miller, 2007; King and Angus, 1996; Ohno and Ohno, 1986; Hayashi and Munakata, 1984). Gena and Strom map parameters such as types of codon, hydrogen bonding and molecular weight (Gena and Strom, 2001). Dunn and Clark sonify the frequency at which the proteins appear; the more frequently appearing proteins are assigned a more consonant interval than rarer ones. Solubility of the proteins is an important characteristic and is mapped to pitch too: the least soluble in the lowest octave and the most soluble in the highest of three octaves (Dunn and Clark, 1999).

Dunn and Clark describe some parallels between proteins and music. Clark declares that amino acid sequences 'have the right balance of complexity and patterning to generate musical combination that would be both aesthetically interesting and biologically informative' (Dunn and Clark, 1999, p. 25). Furthermore, like a musical theme that is not defined by absolute pitches but rather by intervals, protein sequences are described by overall patterns rather than absolute sequences (Dunn and Clark, 1999, p. 27). They in fact describe the potential of protein sonification to exist in the middle of the functional-artistic spectrum.

The sonification of plant data can reveal inaudible phenomena of living organisms but also make noticeable changes in plants which are too slow for humans to perceive. This is the basis for Gibson's plant study data sonification; he uses the curvature of the plant towards light as a data parameter (Gibson, 2006, p. 43). He admits to tweaking the resulting music during the performance 'intuitively', thus putting more importance on the musical performance than the transmission

of information. The sonification of electrical signals in plants is popular because of its relatively simple set-up and immediate response to touch. The changes in the plant are immediately audible and therefore highly attractive to sonification enthusiasts. As part of the growing biofeedback and biohacking movement, the business *Data Garden*⁹ commercialised the *MIDI Sprout*¹⁰ in 2014, which allows users to sonify plants, human skin¹¹, or anything else emitting electrical signals. *Plants FM*¹² provides a live stream of the sonification a snake plant at the *Data Garden* headquarters.

Ricardo Climent's piece *Oxidising the Spectrum* uses microbes and their changes in activity as an 'instrument'. Microbial fuel cells generate electricity; these data are used to control several musical parameters. Unfortunately, the resulting data are relatively uninteresting musically, as they 'rapidly develop and then more steadily decline until they die' (Leamy, 2008, p. 48). In order to alter this curve, the composer alters the cells' changing life conditions (for example temperature and glucose levels), thus modifying the electrical charges and discharges, and creating new curves. The composer harnesses the organism's behaviour and creates new behaviours to create musically interesting patterns.

2.7.2 Human Body

Data from bodily phenomena have proven a popular choice for sonification. Data such as heart rate or electroencephalogram (EEG) are particularly well suited to sonification because they need little modification to be heard in the human range. EEG is also the only brain technology which can run in real-time (Wu et al., 2009,

⁹ <http://www.datagarden.org/>

¹⁰ <http://midisprout.com/>

¹¹ <https://youtu.be/2kCYAUqc8to>

¹² <http://www.plants.fm/>

p. 1), which makes it ideal for a live performance. An early example of EEG audification is Alvin Lucier's *Music for Solo Performer* (1965) which audifies alpha brain waves (8-13 Hz) by exciting percussion instruments with the sound signal. Alpha brain waves occur in a state of relaxation, the performer has to close their eyes and relax to produce them. Alpha waves have a decaying amplitude envelope which produces a 'decrescendo roll' on the percussion instruments (Straebel and Thoben, 2014, p. 23). The EEG signal is rather noisy but the audification of EEG can nevertheless reveal patterns not easily perceived on a spectrogram, for example (Hermann et al., 2002). Experiments with sonification of EEG data taken during different states of sleep can also reveal an audible difference between them (Wu et al., 2009).

Do different sonifications of the same dataset sound in any way similar or related? This question was investigated by the Listening to the Mind Listening project which assigned the same dataset for sonification to 34 composers (Barrass et al., 2006). The data were of electrical brain activity from a person listening to a piece of music, hence the title Listening to the Mind Listening. The musical styles of the sonifications were varied, ranging from jazz to techno (Barrass et al., 2006, p. 13). Because of the necessary decisions taken by the composers at the 'data handling, analysis, mapping and sound-generation stages of the process', the results were all quite different (Barrass et al., 2006, p. 18); this proves the importance of the sonification designer's decisions and skills.

Atau Tanaka combines a number of electrical signals produced by the body in his work *Biomuse*. By attaching electrodes to his lower arms he records electromyography (EMG), EEG and electrooculogram (EOG) signals which represent muscle tension, brain activity and eye tracking. These are then turned

into 'musical control signals' or MIDI signals (Tanaka, 2012, p. 160). The advantage of having the electrodes attached to the arms and tracking a number of signals is that the tensing and relaxing of the arms can significantly alter these signals. The body therefore becomes an instrument which can be controlled in real-time. This is of real interest when seeking a musical performance as the performer has control over their performance.

2.7.3 Environment

If the body as the internal environment is very popular for sonification, the external environment has also provided ample inspiration for musification. Heitor Villa-Lobos *New York Sky Line* (1957) uses the skyline of New York as a score for a piano piece. The rising and descending features of the city are 'read' from left to right and mapped to a musical stave. The harmonic accompaniment added by Villa-Lobos is particularly pleasant and the piece should be considered a successful example of musification. As Taylor discusses, this could be considered as sonification because the composer uses the skyline 'as an index to musical pitch'. While this approach is susceptible to gimmickry and sensationalism, this example succeeds because of Villa-Lobos' skill: 'the skill of the translator matters greatly when converting data to music' (Taylor, 2017). This sonification approach was indeed popular with other contemporaries of Villa-Lobos, although they would not have been conceived as sonifications but rather as musical metaphors. Examples include Karlheinz Stockhausen's *Gruppen* (1955), which references the Swiss mountains in Paspels, and Alvin Lucier's *Panorama* (1993) which transcribes the panorama of the Swiss Alps for slide trombone and piano (Straebel, 2010).

Seismic data are well suited to musification because they can be audified in a quite straightforward manner. For *Pulse of the Earth*, Abenavoli uses samples of seismic data spanning several years, and compresses the length and reduces the amplitude of the signal (Abenavoli, 2012, p. 278). For the installation, light effects are used in the darkened performance space to underline the seismic movements of the earth (Perron, 2000). Dombois claims that the audification of seismic data can also contribute to the detection of earthquakes; he coins the term 'Auditory Seismology' (Dombois, 2001, p. 227). A number of further examples of earthquake sonification can be found (f.ex. Dunham and Johnson, 2015; Prebble, 2010; Kilb et al., 2012).

The jungle is the data source for Natasha Barrett's successful musification piece *Viva la Selva!* (1999). She uses a jungle's spatial information in a 24-hour time span to create piece of acousmatic music with the same spatialisation. At the outset, the listener is confronted with a reconstruction of the original sonic environment through data-based spatialisation (Fig. 2.6); sounds mapped onto the data are taken from the synchronised recordings. By meticulously mapping all these sonic events in space, Barrett effectively manages to create a natural environment in a stereo piece (x-dimension by panning, y-dimension by pitch, z-dimension by filtering and reverberation). The piece is an example of data mapping to an under-used musical parameter, space; however, spatialisation is a crucial parameter in composing acousmatic music (Barrett, 2007, pp. 241-242). Interestingly, another composer took inspiration from the jungle of Costa Rica to write a similar piece only a couple of years earlier. Francisco López' *La Selva* (1997) uses sound recorded in the same jungle in his 70-minute long piece. Crucially though, he does not use any dataset or sonification methods. He claims that he had no intention of 'documenting' the environment, he is more interested

in the sound. Although the piece follows the soundscape over the course of a day, it is ultimately guided by the sound matter itself (López, 2001, p. 163). The main difference between these two remarkably similar pieces is thus the compositional process and the composers' intent to reveal it or not; Barrett initially sets herself musical constraints deriving from a sonification process which she documents clearly (Barrett, 2007).

John Eacott's work *Flood Tide* (2008) is a live performance sounding the tide of the Thames over up to six hours (Eacott, 2012). The tide height data are mapped into musical notation in real-time, to be performed by an ensemble of various instrumentation. The composer suggests that the work was well received because of the real-time data mapping, the musical score being on computer screens, 'the marriage of musical composition and nature', and the outdoor setting of the performance (Eacott, 2012, p. 190). However, he acknowledges that in order to really learn something about the data, one would have to read the information display panels which condensed the data over six hours into a compact data display (Eacott, 2012, p. 193). In fact, the real-time tide data are difficult to sonify because of the time-related nature of the data. While the piece was met with curiosity and some fascination for the process, the process of sonification was largely ineffective.

Buoy data are often freely available on the internet, although a slight delay might exist between measurement and publication online to allow for quality control (for example the Channel Coast Observatory¹³). Sturm claims to have produced the first sonification of buoy data from the Coastal Data Information Program (Sturm, 2005, p. 143). He maps the wave spectra to oscillator frequencies in a process

¹³ <http://www.channelcoast.org/>

of additive synthesis. Other parameters in the buoy data is used to modulate the parameters of the sound synthesis. This straightforward method produces good results for comparing the data over the course of the year as the differences are clearly audible. Two recent sound installations have used buoy data sonification: David Gauthier's *Measure for Measure for Measure* (2017) at Liverpool's *The New Observatory* and David Berezan's *Sea Lantern* (2017) at Manchester's *John Rylands Library*. Unfortunately, little is known about the technical details of these as they appear heavily focused on artistic aspects, rather than research; documentation is therefore lacking.

2.7.4 Weather and Climate

Climate change is a recurring source of inspiration and data for artists working with sonification. Most state the desire to raise awareness about the phenomenon (Knebusch, 2007; Adderley and Young, 2009; Polli, 2006; Quinn and Meeker, 2001; Ensia, 2015) while also seeking ways of re-connecting with their environment (Knebusch, 2007). The representation of weather phenomena has always been a popular activity amongst composers – with a particularly strong tradition amongst British composers (Aplin and Williams, 2011, p. 301). While the representation of climate change can take many artistic forms (see for example Giannachi, 2012), the use of sonification is an obvious one; the effects of climate change are often perceived through data rather than actual experience. Artists and composers have a strong role to play in the fight against climate change, as they might help resolve 'Giddens's paradox': 'since the dangers posed by global warming aren't tangible, immediate or visible in the course of day-to-day life, [...] many will sit on their hands and do nothing of a concrete nature about them. Yet waiting until they become visible and acute before being stirred to serious action,

will, by definition, be too late' (Giddens, 2009, p. 2). By making the data behind climate change 'tangible' or at least audible, composers can encourage action before the effects of climate change become cognitively perceivable. In this case, hearing is believing.

Many of the works sonifying climate change data use fairly 'standard' data to sound mappings. Quinn and Meeker's *The Climate Symphony*, for example, assigns 'low melodies' to cooler temperatures and 'high melodies' to hotter temperatures when sonifying 550 years of solar intensity (Quinn and Meeker, 2001, p. 59). Crawford's *A Song of Our Warming Planet* (2013) maps the average temperature of different latitudes to the instruments of a string quartet; the higher the temperature, the higher the notes played. While this piece gathered an impressive amount of media attention (Ensia, 2015), it uses very simple mappings and sounds rather soothing, thus not conveying the emotional content of the data.

Polli's work contains more interesting uses of climate change data and their mappings. Her installation *Heat and the Heartbeat of the City* sonifies the temperature of New York City over a number of the days. While she mapped the temperature to frequency, as seen in most examples, she also takes into account consecutive hot days. She maps that information to increased pitch and loudness to create 'an "uncomfortable" change in the sound' (Polli, 2006, p. 44). This is a simple way to reflect the temperature of the city but also the patterns over a number of days and what they 'feel' like. The emotional content of the dataset is reflected in the sonification. Her installation *Atmospherics/Weather Works* maps storm data to sound. Interestingly, she also maps the spatial position of the data

source in the installation; 15 speakers for the spatialisation of the data (Polli, 2005, pp. 33-34).

The most tangible effect of climate change is probably global warming, therefore most installations use temperature datasets as their data source. Adderley and Young's *Groundbreaking* investigates the change of fertility of the soil in the African Sahel (Adderley and Young, 2009); while the cause of this change is global warming, the dataset is radically different. They use samples of soil from the Sahel as data. Because they employ image-to-data mapping, these data have no temporal dimension; they had to organise the data as to create this temporal dimension. Adderley and Young describe this process as *interpretive sonification* because they use 'higher-level' mappings which evidence 'structural relationships' in the original data (Adderley and Young, 2009, pp. 407-408).

2.7.5 Astronomy and Particle Physics

Particle physics is another popular field for sonification design because the resulting datasets are very big and complex; novel methods of analysing and understanding them are always sought. Since 2011, *CERN* has appointed prestigious artists in residence (Elisabeth, 2011) which demonstrates a desire to foster collaboration between science and art, with potential benefits for both disciplines. All major particle physics experiments have at some point produced a sonification of their data, namely CERN and the Higgs-Boson (Vicinanza, 2012), the ATLAS experiment at CERN (Cherston et al., 2016) and the gravitational waves at LIGO (LIGO Scientific Collaboration, 2016). The three examples have a commonality: they are 'a bit tedious' (Miranda, 2016). I share Miranda's review of the ATLAS sonification as I doubt their musical and scientific quality; this is further discussed below. The sonifications presented here are for the purpose of

public dissemination and popularisation (Pesic and Volmar, 2014; Bjørnsten, 2015) and have been developed by experts of fields outside of auditory design and music.

The *LHC Symphony Orchestra* produced a sonification of the occurrence of the Higgs-Boson which maps particle mass to notes on a diatonic scale. Pesic and Volmar describe the arbitrariness of the mappings: ‘for instance, the notes #6 (G) and #8 (C) in Fig. 6(b) are a perfect fifth apart but represent neighboring lines in the graph 6(a) [Fig. 2.6 and 2.7]; note #12 is higher than #8, which represents a lower line in the graph. [...] Then too, their criteria impose a diatonic scale on the data (mapping a data value of 25 to C, 26 to D, 28 to F, etc.). The resulting diatonic melody is a pure artefact of this initial choice’ (Pesic and Volmar, 2014). If the mapping of the data is dubious, the musical quality of sonification is also in doubt. By confining themselves to three octaves of a diatonic scale and using various MIDI instruments, the sonification designers have severely limited their musical scope and thus their potential emotional outreach. The occurrence of the Higgs-Boson particle is the message that the interpretation of the data is conveying, but this is barely conveyed in the music. Had they mapped to further musical parameters, such as dynamics and timbre, the composition could have made the apparition of the particle exceedingly obvious, while increasing the musical interest of the piece. We must note that both the Higgs-Boson and the ATLAS sonification have attempted to diversify their musical language by using different MIDI instrument sounds or different musical styles; the ATLAS sonification allows you to switch between ‘House’ and ‘Samba’ styles. While laudable, these musical options add little to the effectiveness of the sonification and underline the lack of musical skill of the designers.

At this point, we should shortly remind ourselves of the large media attention that these sonifications get; my own sonification of dark matter was mentioned in the *Observer* (Davis, 2016), the *Independent* (Clark, 2016) and *Nature Physics* (Miranda, 2016). Perhaps paradoxically, this media interest is often detrimental to the public and academic perception of sonification: as a dissemination gimmick, surely not a serious scientific or compositional method. This is particularly prominent with examples such as the Higgs Boson and gravitational waves where a number of problems collude: 1) Low quality sonification by novice sonification designers 2) Attention-grabbing headlines proclaiming the ultimate ‘sound of ...’ without detailed explanation of underlying data and processes 3) Complex topic for a general audience which accepts the information without questioning. These points sum up the aforementioned ‘conversion hysteria’ around data sonification.

Bjørnsten offers a possible solution when discussing the Higgs Boson sonification. He reiterates our argument that scientists must collaborate with sound and music specialists to create useful sonifications (Bjørnsten, 2015):

If the shortcomings of the affordances of data sonification is partly due to an underdeveloped awareness of what it is that we actually explore when listening to transcoded data, then we might learn something from practitioners working with conversions of sound from a slightly different approach than that of more traditionally trained scientists and software engineers, for instance. This includes, as well, certain artistic practices that would not consider it as their ideal to turn selected data sets into Mozartian pastiches, but would rather seek to circumvent such aesthetic conventions while being highly sentient of the situatedness and contextualization of the data they employ.

The ‘contextualisation of the data’ allows us to choose the appropriate ‘aesthetic conventions’ and is central to the methodology of this project.

The sonification of particles – invisible, inaudible and intangible – brings aesthetic challenges as there is no intuitive linkage between data and possible sound. This issue has been recognised by most designers (for example, Fryer, 2015); Vogt and Höldrich specifically examine the use of sonic metaphors to sonify and

identify different particles (Vogt and Höldrich, 2010). Sine waves are often used as sound source because of their abstract nature and simple implementation in sound synthesis (McGee et al., 2011; Ballora, 2014). The use of pre-recorded instrumental sounds such as MIDI (Vicinanza, 2012; Ballora, 2014) or Ableton Live Instruments (Cheston, 2016, p. 1650) is another common method.

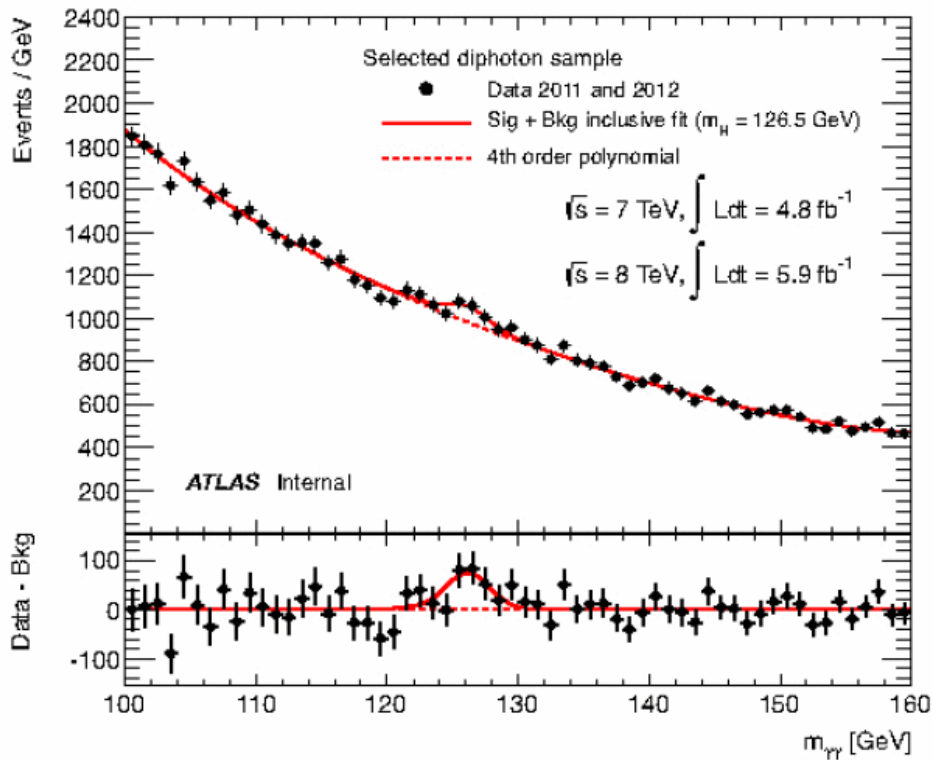

Fig. 2.6: Higgs boson data (Credit: ATLAS collaboration; copyright CERN), showing the number of events observed plotted against the invariant mass in GeV. The lower register shows the background as a straight line, highlighting the appearance of the “bump” at 126.5 GeV, interpreted as the invariant mass of the observed Higgs particle. (Pesic and Volmar, 2014)

Higgs Boson (ATLAS Preliminary data)



Fig. 2.7: Sonification by Domenico Vicinanza, from LHC Open Symphony. (Pesic and Volmar, 2014)

2.8 Conclusion

2.8.1 Musification

We have defined musification: a sonification with musical structures and artistic purposes, which occupies a central position on the functional-artistic spectrum. Its qualitative evaluation remains an issue to resolve.

2.8.2 Challenges

We have identified challenges encountered in producing musifications of high quality that are both functionally and artistically valuable. They include:

- Ineffective information transmission through poor data handling, mapping and sound production.
- Lack of emotional connection between data and sound through arbitrary and inappropriate data to sound mappings.

- Lack of aesthetical considerations in sonification design.
- Danger of sensationalism leading to poor quality outputs and loss of reputation for the method.
- Continued search for a 'killer application' to establish sonification as a serious method of information transmission and/or compositional tool.
- Lack of specialists with sufficient skill and knowledge to handle all aspects of sonification to a high standard.

2.8.3 Proposed Solutions

We are proposing some solutions to inform the methodology of the project, in order to overcome the challenges discussed:

- Working as a 'scientist-composer', with sufficient knowledge of the data, the sonification process, and aesthetic conventions to facilitate information transmission and create appropriate emotional connections between data and sound. Using practice-as-research methodology to harness embodied practitioner's knowledge which can bridge the existing gap between scientists and composers producing sonifications.
- Producing high quality outputs through my own compositional practice as a 'scientist-composer'.
- Search for the 'killer application' for different types of data.

Chapter 3

Blyth-Eastbourne-Wembury: A Framework for Musification

This chapter¹⁴ discusses the first musification of the project: the piece *Blyth-Eastbourne-Wembury*. The critical reflection on the composition process is used to propose the **Data-Mapping-Language-Emotion** framework for Parameter-Mapping Sonification (PMSon) in creative practice. The chapter describes the data, sound mappings, musical language and emotional content of the musification, and combines the concepts to theorise the compositional framework.

The piece can be found on the accompanying CD (see Appendix 2) as *Blyth-Eastbourne-Wembury*.

3.1 Overview

The piece was commissioned in August 2015 by the National Union of Students for the launch event of the *Students Organizing for Sustainability* network (SOS, 2017) held at the *Eden Project* (Bodelva, UK) on 9 October 2015. Their brief called for creative responses from ‘students at the forefront of change and taking the lead in the fight against climate change’ (NUS, 2015) to be presented during the event. I proposed an acousmatic piece for fixed media incorporating the sonification of sea temperature and salinity data which points to climate change in the United Kingdom.

¹⁴ This chapter is based on Bonet et al. (2016a).

The choice of datasets and the source of sound recordings explain the title of the piece, *Blyth-Eastbourne-Wembury*. Eastbourne is the location of the sea temperature measurements used for the data sonification. Blyth is the northernmost measuring station in England used by the Centre for Environment Fisheries and Aquaculture Science (CEFAS). Finally, the majority of the sound recordings for the piece were made in Wembury.

The piece has been performed at the Eden Project, at Bangor University and the University of Manchester. A communication on the resulting musification framework was presented at the conference for New Music Concepts in Treviso, Italy on 5 and 6 March 2016 (Bonet, 2016a).

3.1.1 Compositional process

The data were chosen for their relationship to the climate change brief as well as the musical potential of their patterns. The short sonifications produced from the datasets were used as musical material for the wider composition; they could be described as primary and secondary melodies accompanied by a 'non-sonified' marine soundscape. The sonification elements bear a close relationship to the original data but their implementation within the larger context of the piece relies on musical intuition and compositional skill. The synthesis techniques were chosen for their ease of use and their aesthetics.

3.2 Data

The data consist of temperature measured in Eastbourne and salinity measured in the English Channel (Fig. 3.1); these are available from CEFAS¹⁵ (Joyce, 2006, pp. 62-64 and 106-114).

3.2.1 Temperature

The temperature dataset contains monthly average values from 1892 to 2004. Eastbourne was chosen for sonification because its dataset presents the largest and most complete record (only the years 1942-46 are missing). The report shows that the average temperature from 1971 to 2004 is 0.55 C° above the average temperature of the whole set (Joyce, 2006, p. 64; Table 3.1). Thus, the sea temperature has significantly risen in the past four decades, indicating that 'long-term change' in temperatures is 'distinguishable' (Joyce, 2006, pp. 17). The temperatures in the whole data set range from 0.4 to 20.4 C°, the mean data set ranges from 5.4 to 18.3 C°. Figure 3.2 shows that the monthly average temperature in the 1971-2000 dataset has increased.

3.2.2 Salinity

The salinity data are monthly averages from 2002 to 2004, taken on the ferry route in the English Channel between Harwich and Rotterdam; the location is labelled as Position 2 in CEFAS' report (Fig. 3.1). The precise definition of salinity is complex and beyond the scope of this project; however, it can be approximated as the amount of salt (in grams) dissolved in a volume of water (in kilograms). The ocean's mean salinity is ca. 35, which equals ca. 35‰ of salt in seawater (UNESCO, 1981, p. 141). Note that salinity does not have a unit but Practical

¹⁵ <https://www.cefas.co.uk/publications/files/datarep43.pdf>

Salinity Unit (psu) is often used, for example in the CEFAS report, although this is formally incorrect (Pawlowicz, 2013, p. 13). The dataset used for sonification ranges from 32.757 to 34.755 (Table 3.2).

Salinity in the Atlantic Ocean has a cyclical nature during the year, with a decrease in spring and an increase in autumn. However, this cycle is less regular than the temperature cycle which presents fewer anomalies (Fig. 3.3). The salinity can vary depending on the location of measurement due to the currents in the English Channel. Even if the increase of the mean salinity values is less pronounced than for the temperature dataset, it is still statistically significant. The data for the years 2002, 2003 and 2004 were chosen for their potential for mapping as musically interesting gestures (Fig. 3.3).

3.2.3 Telling Climate Change

The data used for *Blyth-Eastbourne-Wembury* are relatively simple. The sea temperature dataset, for example, contains 1284 data points between the values of 0.4 and 20.4. Once the average monthly temperature of the entire dataset and the subset of 1971-2000 have been calculated, 24 values between 5.4 and 18.3 are effectively used for sonification. The dataset is relatively simple to handle and understand; calculations such as determining mean values can be sufficient. However, the dataset 'on its own' reveals little, only coupled with context does it become information (Roddy and Furlong, 2014, p. 75). The higher-level meaning of the data shapes the story told in the musification: rising sea temperature as a signifier of global warming. In fact, the long-term trend of increasing sea temperature and salinity are possible indicators of climate change. In turn, the rise of salinity has been identified as a factor in rising sea levels which can have catastrophic consequences for human populations (Durack et al., 2014). The

datasets presented here therefore contain information relating to the phenomenon of climate change on the British coast; this is the reason why they were chosen to respond the NUS brief seeking artists dealing with climate change in their work.

The data contain some potential musical structures which are harnessed during the mapping process: the wave shape of the annual temperature cycle, the cyclical nature of the data, and the potential for dissonances if mapped accordingly. The structure of the data contributes to the storytelling as it reflects the musical elements which support the narrative about climate change.

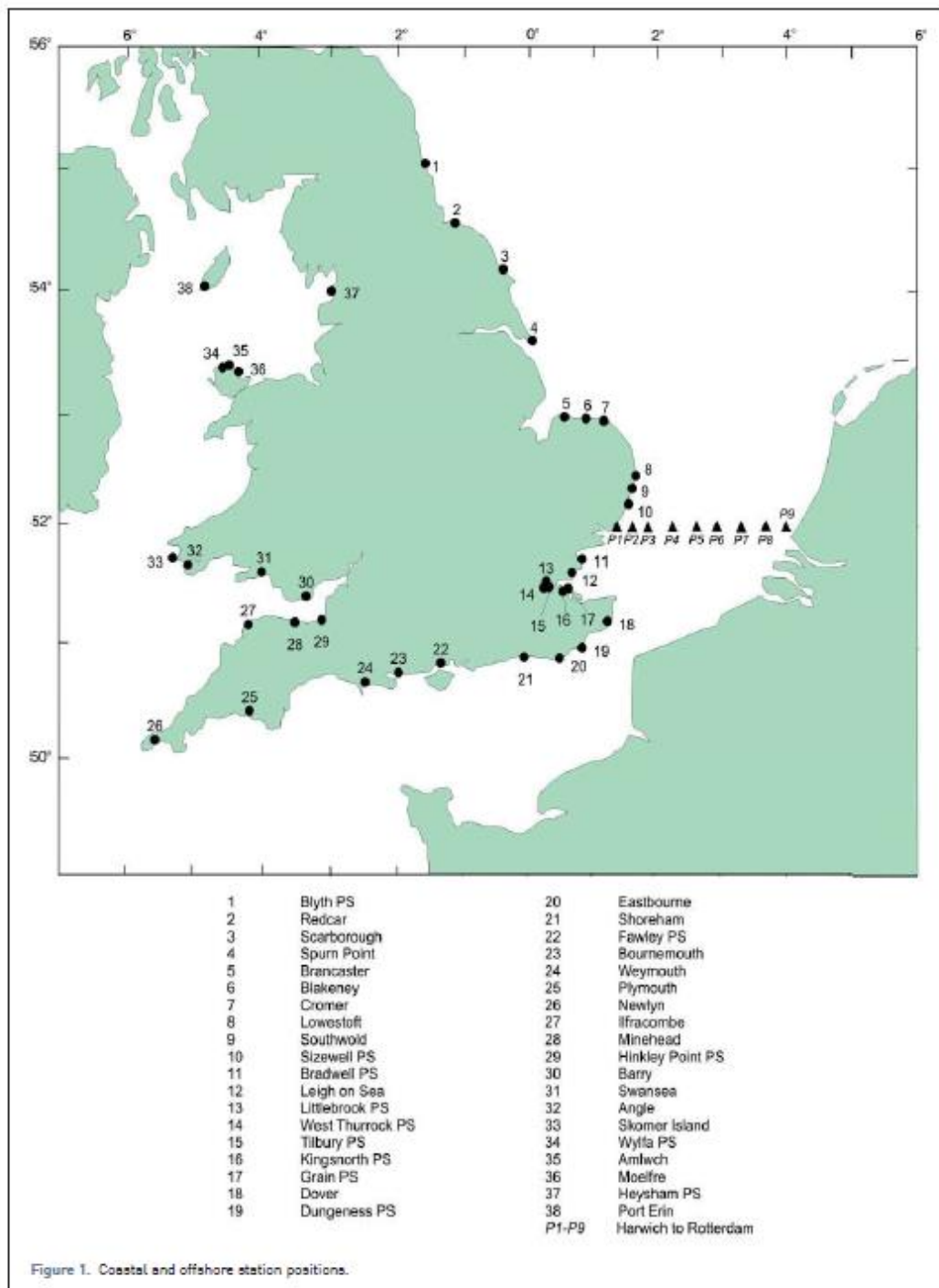

Fig. 3.1: Map of coastal and offshore station positions (Joyce, 2006, p. 7). Eastbourne is at point 20. Position 2 on the Harwich-Rotterdam ferry is at P2.

Tab. 3.1: Mean and standard deviation of monthly sea temperatures in C° for Eastbourne, for the whole data set and for the period 1971 – 2000 (Joyce, 2006, p. 64).

Temperature in C° (whole data set)												
	Jan	Feb	Mar	Apr	May	Jun	Jul	Aug	Sep	Oct	Nov	Dec
mean	6.0	5.4	6.2	8.4	11.7	14.8	17.1	17.9	16.5	13.6	10.2	7.5
sd	1.37	1.5	1.33	0.98	0.87	0.76	0.81	0.90	0.95	1.00	1.12	1.10

Temperature in C° (1971 – 2000)												
	Jan	Feb	Mar	Apr	May	Jun	Jul	Aug	Sep	Oct	Nov	Dec
mean	6.4	5.7	6.5	8.6	11.7	14.9	17.2	18.3	16.8	14.0	10.7	7.9
sd	1.36	1.35	1.37	0.94	1.13	0.91	0.91	0.95	0.92	0.94	1.12	1.08

Tab. 3.2: Salinity values in psu at Position 2 for the period 2002-2004 on the Harwich-Rotterdam ferry.

Salinity in psu (2002-2004)												
	Jan	Feb	Mar	Apr	May	Jun	Jul	Aug	Sep	Oct	Nov	Dec
2002	33.641	33.693	33.424	33.637	33.693	34.177	34.552	34.3	34.2	34.071	33.973	34.423
2003	33	32.883	32.757	33.016	33.095	33.991	34.226	34.605	34.463	34.63	34.486	34.7134
2004	34.454	34.087	33.452	33.725	33.943	33.977	34.236	34.172	34.632	34.755	34.6	34.112

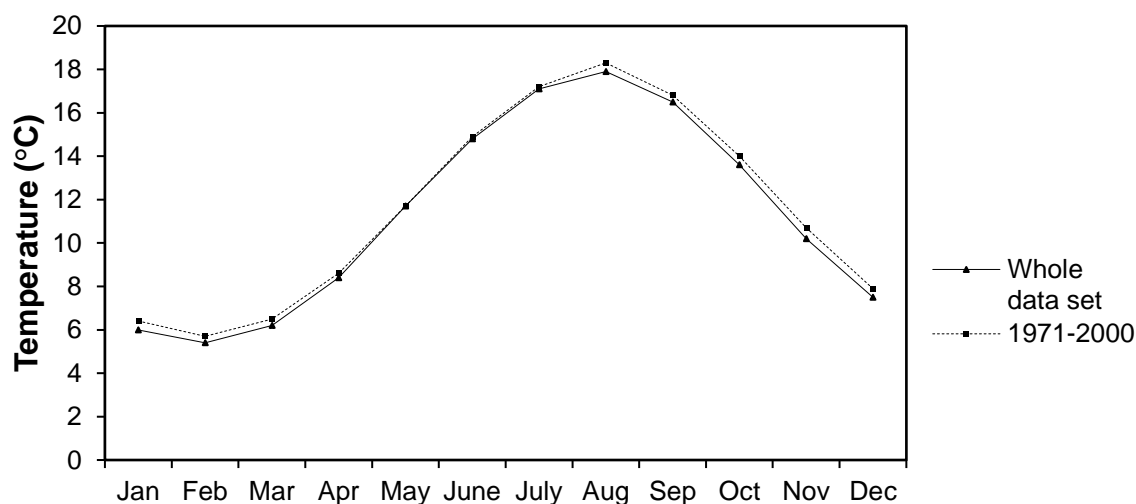

Fig. 3.2: Monthly averages of seawater temperature in C° at Eastbourne for the entire data set and for 1971-2000 (Joyce, 2006, p. 64).

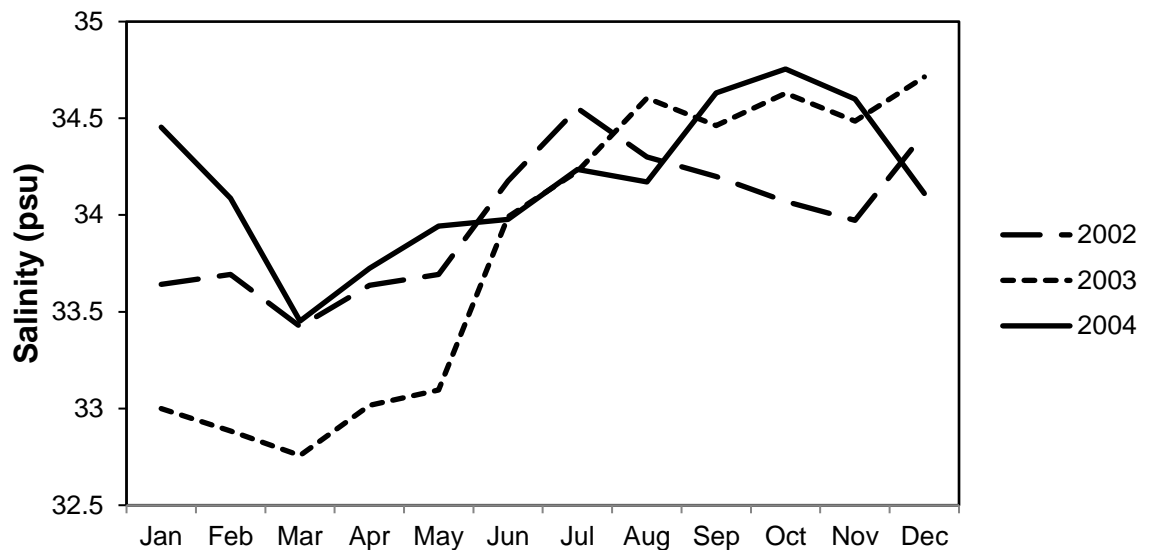

Fig. 3.3: Salinity in psu at position P2 on the ferry route between from Harwich to Rotterdam for the years 2002-2004 (Joyce, 2006, p. 144).

3.3 Mappings

3.3.1 Temperature

The average temperature values of the whole dataset and its subset 1971-2000 (Table 3.1) are mapped so that 5 - 20 C° is scaled to 75 - 800 Hz. The mapped frequency determines the frequency of a sine wave; the two datasets are sonified as two sine waves. When played simultaneously, these produce varying degrees of dissonance according to the discrepancy between temperature values for each month.

The beating dissonances produced by the juxtaposition of the sine waves create a powerful psychoacoustic effect. In fact, they are never resolved and augmented to almost uncomfortable levels at times over the course of the piece. The higher-level information about the rise of the seawater temperature after 1971 is sonically represented by dissonances. The correct choice of mapping is crucial to create this effect, as a mapping resulting in consonance between the two

frequencies (because of a larger frequency range) would lose the intended psychoacoustic effect.

This sonification will be called *temp1*.

3.3.2 Salinity

The monthly salinity values of the year 2004 (Fig. 3.3) are mapped to the centre frequency of a bandpass filter which is applied to a noise signal. The range of 33.452 - 34.755 is mapped to 916 Hz - 7740 Hz. A rise in centre frequency, for example, is heard as a pitch rise as the white noise is filtered. The first three data points sound like downwards sweep because the centre frequency of the bandpass filter changes from 6185 Hz to 916 Hz in 4.5 seconds. The resulting sonic gesture is reminiscent of a crashing wave, an interesting musical gesture which justifies the use of these particular data.

This sonification will be called *sali1*.

The salinity values from 2002 to 2004 are used for melodic purposes because each year presents some variations while following a similar trend. Individual values in the dataset determine the tempo and frequency of a single note which is repeated ten times, before the next value determines the tempo and frequency of the next single note. Values between 33-35 psu are mapped to 50-250 Hz for the pitch; 33-35 psu are mapped 250-210 ms for the tempo of each note. The sound source is the synthesis of a plucked string using the Karplus-Strong algorithm (Karplus and Strong, 1983).

This sonification will be called *sali2*.

3.3.3 Software

The data to sound mappings are implemented on Max 7 as it allows simple number handling and frequency mapping to oscillators. The sonification is recorded and exported as a sound file which can then be used as source material in the larger scale composition.

3.4 Musical Language

The musical language employed in parameter-mapping based sonifications is often that of the Western Classical Music tradition; an idiom heavily based on pitch, rhythm and harmony. The implications of using a specific musical language were discussed in 2.3.3: its connotations can be harnessed for the transmission of information, but it can also limit the possibilities of an auditory display. There is a danger of distorting the sonification process to fit the desired musical form, as exemplified by the sonification of the Higgs Boson sonification, which skews the source data to fit a chromatic scale (Pesic and Volmar, 2014).

The choice of musical language for *Blyth-Eastbourne-Wembury* is heavily influenced by the nature of the data, my own compositional practice and the context of the performance.

3.4.1 Sonification

The aim of the sonification of the temperature data (*temp1*) is to sound the discrepancy between two datasets, in particular the difference in average temperature before and after 1970. The beating dissonances could not have been achieved on a chromatic or diatonic scale; a microtonal scale is necessary. Therefore, mapping the data to a Western musical scale would have been inappropriate to create the desired psychoacoustic effect.

The use of sound synthesis over the recording of an acoustic instrument, for example for the sonification is justified by the use of a microtonal scale. Microtonality is difficult to achieve precisely on conventional instruments and is often better achieved on electronic instruments (Griffiths et al., 2001). Digital technology such as Max 7 can easily produce the mapped microtonal frequencies.

While the use of *sinification*¹⁶ is often unpopular because irritating during prolonged listening (Barrass, 2012), we have proven that it was appropriate in the context of this musification. This underlines the need for aligning the context of the data with the methods used for composing its sonification.

3.4.2 Soundscape Composition

The sonification is a sound source in the context of electroacoustic composition techniques applied to compose *Blyth-Eastbourne-Wembury*. It is embedded in a soundscape composition which accompanies the data representation in ways that will be further discussed below. Barry Truax defines soundscape composition as follows (2000, p. 124; in: Landy, 2007, p. 106):

The term “soundscape composition” refers to a kind of electroacoustic work [in which... [e]nvironmental sound recordings form both the source material and also inform the work at all its structural levels in that the original context and associations of the material play a significant role and reception.

In other words, the soundscape composition is context embedded, and even though it may incorporate seemingly abstract material from time to time, the piece never loses sight of what it is “about.”

Soundscape composition can be defined as a piece of music which uses recorded elements of a soundscape and organises them in a musical form with a clear relationship between sound and source. It is therefore a form of anecdotal music, with a high degree of *indexicality* (see 2.3.3).

¹⁶ This term is defined by Barrass as a sonification which uses sine waves as a sound source (Barrass, 2012).

Truax states that soundscape composition should have recognisable sound sources which invoke 'the listener's knowledge of the environmental and psychological context of the soundscape material'; it should also 'enhance [...] our understanding of the world' (Truax, 1996, p. 63). The concept of soundscape composition has been chosen to create a sonic world which reflects the soundscape of coastal settings which are associated with the sea temperature and salinity data. Sounds collected at Wembury's beach and Plymouth's Barbican Harbour are transformed and assembled to create an augmented soundscape which harnesses the listener's existing knowledge of the sounds and their emotional connotations with them. Consequently, the composed progression in the soundscape is easily understood by the listener because of their familiarity with the sounds heard.

The performance space and duration requirements of the commission strongly favoured a piece of electroacoustic music, which could be played on loudspeakers and easily looped over a number of hours.

3.4.3 Musification

The combination of the sonification with the soundscape composition anchors the piece in the concept of musification. The data sonification accurately represents the data and could be considered functional when heard on its own. It is however used as a sound source for a larger scale electroacoustic piece; it becomes part of a musical structure. The emotional content of the work has been carefully considered to raise its musical quality, so that it can exist as a self-contained piece of music.

3.5 Emotional Content

The potential lack of emotional connection between the data and their auditory representation is problematic. Intuitively, different types of data should sound different (Smith, 1990) but there are no specific rules on the ‘sound of’ data either; this decision belongs to the designer of the sonification (McGee, 2009). We could argue that there is a difference between data which derive from sources to which specific sounds are attributed (for example sea temperature) and data which are inherently ‘silent’ (for example dark matter). The issue of ‘silent’ data such as dark matter will be further explored in Chapter 4; the lack of sonic connotations offers both challenges and opportunities for sonification. In the case of the data presented in this chapter – sea temperature and salinity – a maritime soundscape comes to mind. We will now discuss how this connotation is harnessed through the sonification and the soundscape composition that are combined in *Blyth-Eastbourne-Wembury*.

3.5.1 Empathetic Sonification

The previous discussion suggests that we must aim to create a sonification which takes into account and transmits the emotional content associated with the dataset to be sonified. The term *empathetic sonification* will be used to describe a sonification with these characteristics (anecdotal, high *indexicality*, intuitive relation between data and sound). It must be noted at this point that rising sea temperature and salinity are perceived as negative environmental developments - examples of catastrophic climate change – which explains the negative emotions attributed to the datasets in the musification.

The key to this empathetic approach is to engage with the emotional component of the information. Polli emphasises the importance of an ‘emotional connection’ to the data as ‘a memory aid’ that can ‘increase the human understanding of the forces at work behind the data’, in relation to her arctic sonification piece *Sonic Antarctica* (Giannachi, 2012, pp. 128). These emotions can then determine musical processes used in the piece in order to transmit them. Polli’s process can be likened to the use of auditory icons, aural metaphors for information transmission. Barrett uses a similar approach in a number of her works; *Aftershock*, for example, is a sonification of rock fragmentation models data which uses recordings of rocks being crushed as a sound source (Barrett and Mair, 2014).

3.5.2 Sonification

The dataset describing the sea temperature can be plotted on a graph to have a wave shape (Fig. 3.2). The sonification as described above results in a sound gesture with a strong connotation of a wave because of its ascending and descending movement. The gesture can also be heard as a siren, which evokes danger and alarms warning about the effects of climate change. When mapped to frequency, the data ‘sound’ like the sea that they describe.

While the concept of salinity does not immediately conjure up an auditory connotation (maybe a gustatory one), the sonification of those data are used to underline the maritime theme running through the piece. The downward sweep gesture from the salinity data sonification (*sali1*) can be heard as a crashing wave. Finally, the data sonification can be used to produce musical material which does not have a direct metaphorical connection to the source of the data, such as the

as the notes using the Karplus-Strong algorithm (*sali2*). It is used as material in the piece to accompany and underline the sonifications with higher indexicality.

3.5.3 Soundscape

The soundscape is composed of sound recordings from Wembury Beach and the Barbican Harbour in Plymouth. Table 3.3 lists and describes the sound sources recorded; a Zoom H4n¹⁷ portable recorder was used for this purpose. The recordings were transformed and arranged to create a musical progression from natural sounds to human sounds. The piece begins with the sound of a river stream, moving on to human-environment interaction such as walking on the beach and stirring gravel. The progression ends with a human soundscape of harbour activity including conversations and car engines. Fig. 3.4 describes the sounds and progression in detail.

In spectromorphological terms, we can describe the soundscapes in the piece as a progression from a 'natural-based' 'source-bonded' space to an 'enacted space', which includes an 'agential space' and a 'mechanised space' (Smalley, 2007, p. 38). Source-bonded spaces indicate a relationship between the soundscape and its source, an empathetic sonification should therefore seek to create a source-bonded space. Enacted spaces are those 'where the sounds produced are byproducts of human activity'. Within enacted spaces, agential spaces contain sounds produced by the interaction of humans with natural elements; in this case the sound stirring gravel or walking on the beach, for example. The mechanised space contains sounds produced by machines, such as cars (Smalley, 2007, p. 38).

¹⁷ <https://www.zoom-na.com/products/field-video-recording/field-recording/zoom-h4n-handly-recorder>

Tab. 3.3: Sound sources for the acousmatic soundscape in *Blyth-Eastbourne-Wembury*.

Sound	Description
River	River stream
Waves	Incoming waves
Wind	Wind noises
Birds	Bird noises
Walking on sand	Walking on the beach
Walking in water	Walking in the river stream (all Wembury Beach, Wembury, UK)
Gravel	Dropping stones and gravel in bucket filled with water Dragging stones and gravel across the bottom of a bucket filled with water
Urinating	Urinating on Wembury Beach
Humans	Human activity on Barbican Harbour
Cars	Cars driving by on Barbican Harbour (both Plymouth, UK)

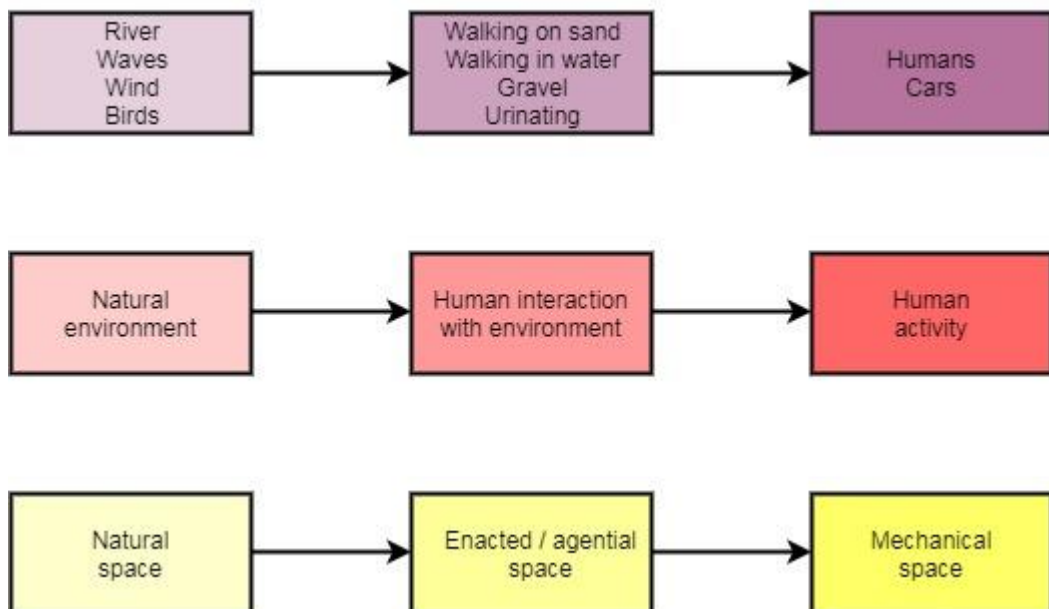

Fig. 3.4: Progression of recorded sounds in *Blyth-Eastbourne-Wembury* from natural source-bonded spaces to mechanical source-bonded spaces.

Soundscape composition can sometimes use a spoken description of what is being heard as a means of focussing the listener's attention on particular sonic aspects, as found in Hildegard Westerkamp's *Kits Beach Soundwalk* (1989). This approach heavily emphasises the process over the musical product, as the listener 'share[s] in her journey' (Kolber, 2002, p. 43). The compositional process, thus the thematic evolution, of the soundscape in *Blyth-Eastbourne-Wembury* is not made explicit. It does not offer a semantic reflection on climate change, for example through a spoken message. Instead, the sonification element of the piece is far more explicit in its meaning, particularly if the listener has previous knowledge of the sonification process employed. Musical connotations such as dissonances suggest a higher-level meaning of the sonifications.

3.5.4 Geosonification

Polli defines the concept of 'geosonification' as 'the sonification of data from the natural world inspired by the soundscape' (Polli, 2012, p. 262). She emphasises the 'high-level choices' necessary in the process of sonification, such as '[r]eshaping numerical data' and 'mapping', which requires more mediation than soundscape composition or audification (Polli, 2012, p. 262). Therefore, geosonification exists within the paradox of being intrinsically related to the soundscape that inspired it while being subject to a heavily mediated process by the hands of its composer. The decisions taken during the sonification process carry meaning, particularly when dealing with geographical soundscapes and data with political importance, such as climate change related data. In *Blyth-Eastbourne-Wembury*, the choice of mappings, for example, reflects a conscious decision to impart meaning on the data; the rise of seawater temperature is

mapped as dissonances which infer a negative meaning. Whether this process and its meaning are understood by the listener depends on a number of factors: knowledge of the data, knowledge of the mappings, knowledge of musical connotations in Western Classical music, familiarity with the soundscapes, etc.

3.5.5 Sonification as Sound Source

The sonification of temperature and salinity data is used as sound material throughout the piece. These sounds are transformed to suit the needs of the piece. The timings described below are shown in Figure 3.5.

The piece begins with a water stream, at 14" (1) we hear footsteps in gravel and at 39" (2) various stone and gravel collision sounds appear. The sonification of the temperature data first enters at 1'05" (3); it is presented quietly and heavily filtered. It functions as a texture to the gravel sound gestures and does not yet attract the attention of the listener. The sonification in its 'original' form is then re-introduced 2'06" (4) where it becomes the main motive of the section. At the same point, the Karplus-Strong version of the sonification appears in counterpoint to the original sonification. This introduces an immersive water soundscape beginning at 3'07" (5) which accompanies the emergence of juxtaposition of different sonifications. The original sonification is transformed to sound like a siren. Meanwhile, the bass line is provided by a distorted and pitch-shifted version of the salinity data repeated sonification. The plucked temperature sonification becomes a melodic motive. Half of the siren motive is played at 3'52" (6) with added reverb and frequency filtering which gives the impression of expanding composed space. The section beginning at 3'56" (7) only plays synthesised sounds until the introduction of heavily transformed gravel sounds at 4'11" (8). These re-introduce real-world sounds which transition to a human soundscape.

The plucked motive and the siren motive tentatively re-appear at 5'10" (9) but give way to a 'solo' appearance of the original motive at 5'24" (10). It acts as a gesture to introduce the 'sweeping' gesture of the salinity data sonification at 5'51" (11). The plucked motive plays as a bridge between the excitement of the climax of the previous gesture and the transition to a soundscape which reverts back to the initial sound stream and walking in the gravel.

The sonification elements serve multiple functions: main motive, accompaniment, bridge, gesture, texture. Through transformations such as EQ filtering, transposition and dynamics, the limited number of motives is used as vocabulary for electroacoustic music. In spectromorphological terms, the sonifications are not source-bonded to any natural acoustic domain because they use sound synthesis. They create an *artificial* space which is salient within the source-bonded spaces of the piece; the sonifications therefore stand out within the recorded soundscapes.

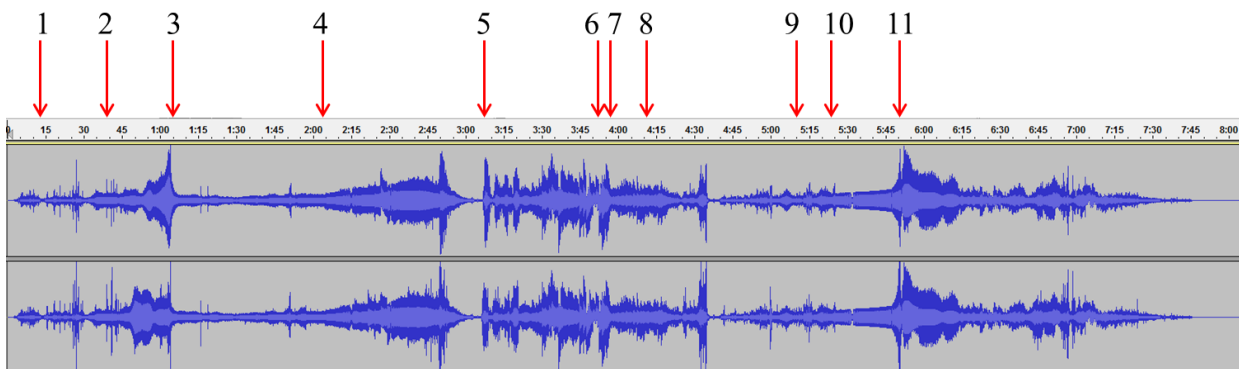

Fig. 3.5: Sonogram of *Blyth-Eastbourne-Wembury* extracted from Audacity¹⁸, it describes the amplitude against time. The numbered events are described in 3.5.5.

¹⁸ <http://www.audacityteam.org/>

3.6 Performance

Blyth-Eastbourne-Wembury has been performed in three different formal settings. The premiere took place at the Eden Project during an event on sustainability; two composers and four artists were invited to present their work in the jungle and Mediterranean biomes. This piece was played through a pair of stereo loudspeakers situated in a hut in the jungle biome (Fig. 3.6 and Fig. 3.7). As it took place during the evening, the space was almost in complete darkness, save for some spotlights on the path and fairy lights in the hut. The piece was played on a loop for approximately two hours. The audience largely consisted of listeners with no experience or knowledge of electroacoustic music. The music played on loop in the form of an installation so that listeners could read about the composition process and ask questions. A number of audience members reported enjoying the music as they had a basic understanding of the concept and the data. A (perhaps) surprising number of emotional responses were also noticed, such as the evocation of being engulfed in a tsunami. This was interesting because it meant that an emotional response had been elicited through an unfamiliar musical language, in a piece that concentrated heavily on process.

The piece was played again on 7 January 2016 at the Royal Musical Association and British Forum for Ethnomusicology Research Students' Conference at the Bangor University in Bangor, UK. It was workshopped during the day with Prof Andrew Lewis and other student composers. It was then performed during a formal concert in the evening. A third performance took place on 4 March 2018 at the MANTIS electroacoustic festival at the University of Manchester, which features large arrays of speakers and a diffusion system. These performances

were mainly attended by composers and listeners with good knowledge and interest in electroacoustic music and sonification. The feedback was equally positive, but rather based on musical and technical considerations. It proved that the musical material – the sonification – had been used well in the context of the genre of electroacoustic music. Furthermore, the technical aspects of the piece had been produced to an excellent standard. The musification had therefore achieved some of the more objective standards of musical quality.

The important conclusion from this feedback is that even with little knowledge of the underlying data and sonification processes, the listeners could gather the desired information and emotionally connect to the musification.



Fig. 3.6: Hut in the jungle biome of the Eden Project where the pair of stereo loudspeakers was situated for the performance on 9 October 2015.



Fig. 3.7: Jungle biome at the Eden Project seen from the outside during the time of the performance.

3.7 Framework

We have described the compositional process of *Blyth-Eastbourne-Wembury* from which the **Data-Mapping-Language-Emotion** framework for musification derives. It describes the four main parameters to consider when designing a Parameter-Mapping Sonification for artistic purposes. It also shows how these four parameters are intrinsically related and changes to any of them affects all others.

3.7.1 Data

An excellent understanding of the data by the composer is crucial to choose and parse datasets that are suitable for the musification process. They need to ensure that the data are suitable for aural display: they must present a structure that can create a musical structure through the sonification process. The step of data handling is integral in the 'storytelling' of the musification as the composer chooses what information they want to transmit. The implication is that the data might transmit some higher-level relationships in the data, and an emotional content derived from the dataset. Data must be coupled with context to become information (Roddy and Furlong, 2014, p. 75). The composer's role in the musification process could be considered as creating the context to contribute to the storytelling. In turn, the data are the starting point of this process; to use unsuitable or poorly handled data means that the whole process is weakened.

The choice of appropriate data should be considered as a compositional choice. Not all data are equally suitable for sonification or suitable to be sonified in a chosen musical language. A particular challenge is the 'big data fetish', where one seeks complex data in the belief that bigger data implies scientific credibility

(Bjørnsten, 2014). Often, the opposite is true as the data are more difficult to handle and transmit, resulting in an incomprehensible aural display.

3.7.2 Mappings

The mapping of data to sound is the process whereby data are rendered audible, and therefore perceivable, by assigning data parameters to sound parameters. The mapping process is determined by the data, the chosen musical language and the emotional content to be transmitted. The success of any sonification is based on these considerations; the criteria for evaluation will be discussed in Chapter 7. The mapping process is often incorrectly understood as the sonification process but it represents only one of the steps in the sonification process. All steps in the process are, however, closely linked and must be considered in parallel when determining the parameters for the mapping process.

The understanding of human auditory perception and psychoacoustics is important during the mapping process. The sonification designer must understand how the sound parameters will be perceived by the listener to transmit information efficiently. Many less successful mappings were identified in the literature review, such as arbitrary data to sound mappings or a lack of emotional connection between data and sound (Angliss, 2011; Smith, 1990), which hinder the information transmission. Their unsuitability has been related to auditory and psychoacoustic factors.

The mapping process might be considered as the most creative aspect of the compositional process of musification because it is 'as arbitrary as it is decisive' (Adderley and Young, 2009, p. 408). The composer has an enormous range of mapping possibilities which will strongly determine the outcome of the sonification process. The listener's understanding of the dataset is directed by the mapping

choices. The seemingly infinite mapping possibilities should be mediated by the data, musical language and emotional content to create a coherent and effective auditory display; thus, the importance of a compositional framework such as this one.

3.7.3 Musical Language

The musical language used in any sonification must be chosen to serve the purpose of the sonification. The information to be transmitted determines the choice. A widely known musical language, such as that of Western classical music, will often be effective as the composer can harness commonly understood stylistic devices (for example major and minor modes). However, converting any data into 'Mozartian pastiches' is inappropriate as it disregards the needs of the individual dataset (Bjørnsten, 2014). Similarly, because different data types should intuitively not sound the same (Smith, 1990) they should also probably not be in the same musical language. Practical limitations might also determine the suitable musical language; for example, available instrumentation or technology, or the performance setting.

In the context of a musification, the choice of musical language is even more important than for auditory displays not intended for artistic purposes. The importance of aesthetics in non-artistic sonification has been discussed in 2.3. The aesthetics of the sonification should be appropriate to the purpose of the sonification; alarms should be disruptive but displays for long-term monitoring should not be irritating. A musification will serve a purpose in information transmission, which determines some of its musical considerations; it will also serve musical purpose which will further influence this decision. The musical purpose could include the performance space (for example a 50-seater concert

venue or outdoors), the musical form (for example a 3-minute piece or a looping installation) and the audience engagement (for example a sit-down concert or *muzak*).

3.7.4 Emotional Content

The term *empathetic sonification* has been introduced to describe sonification with high *indexicality*, which reflects the emotional content of the dataset. This can be achieved through a variety of parameters that contribute to the overall storytelling of the sonification. The emotional content is determined and represented at all previous stages of the framework. The thorough understanding of the data informs the information to be transmitted; this might involve data handling to bring out interesting relationships in the data. The mappings and their musical language transform the data into sound, and potentially music, which inherently carries emotional connotations.

To write a musification, there are further musical parameters to consider for the empathetic transmission of information. The performance setting of a musification can provide an added layer of artistic intent which aids the contextualised information transmission of the musification storytelling.

3.8 Conclusions

This chapter describes the compositional process of *Blyth-Eastbourne Wembury*. The piece uses the sonification of temperature and salinity data as compositional material for an electroacoustic work; its other sound sources are recordings of coastal environments, which are used to create a soundscape to accompany the sonification. The data sonification is clearly a musification: its inherently musical structures are harnessed in the compositional process. The context of the piece

as ‘concert’ music fulfils the condition of artistic intent. In fact, two performances with very different musical contexts are discussed, describing how the piece works in its artistic function. Furthermore, we have shown that the aesthetic decisions taken concerning mappings and musical language aid the understanding of the data.

The steps described in the compositional process inform the **Data-Mapping-Language-Emotion** framework for the composition of sonifications. It describes each step and demonstrates their inter-relatedness. It becomes apparent that they must all be considered when designing a sonification. We have also shown how they must be considered to compose a musification; the concept of storytelling becomes central in this respect.

Chapter 4

***The Sonification of Dark Matter:* Interdisciplinary Collaboration and the Scientist-Composer**

‘Le silence éternel de ces espaces infinis m’effraie.’
‘The eternal silence of these infinite spaces frightens me.’
Blaise Pascal, *Pensées*

This chapter¹⁹ describes the compositional process of *Sonification of Dark Matter* which uses of the Data-Mappings-Language-Emotion framework for musification. The issues of interdisciplinarity and collaboration that arose are described. The application of the musification framework to such interdisciplinary collaborations is discussed.

The piece can be found on the accompanying CD (see Appendix 2) as *The Sonification of Dark Matter*.

4.1 Overview

Sonification of Dark Matter stems from a collaboration with the Kavli Institute for Particle Astrophysics and Cosmology at Stanford University²⁰, with Dr Ralf Kähler as main contact. His team’s work on a novel visualisation method for N-body simulations of dark matter (Kähler et al., 2012) provided the data and visualisations used (Fig. 4.1, Fig. 4.2 and Fig. 4.3).

¹⁹ This chapter is based on Bonet et al. (2016b).

²⁰ <https://kipac.stanford.edu/>

The piece was premiered at the Peninsula Arts Contemporary Music Festival at Plymouth University on 26-28 February 2018. It was played again as an installation at the Sound and Music Computing conference in Hamburg on 31 August to 3 September 2016. On this occasion, a poster on the project was also presented (Bonet, 2016b).

4.1.1 Aims

The aims of this project are twofold. First, the sonification of the data should improve the originally silent visualisations of very complex data. These videos can be disconcerting for the audience because we have come to expect 'sound to accompany animated images' (Scaletti and Craig, 1991, p.10). The potential 'additional bandwidth' afforded by sonification can enhance the audience's experience (Scaletti and Craig, 1991, p. 10), while helping to understand the subject matter.

Secondly, the use of complex data as a tool for composition needed to be explored through the process of musification. The practical application of the Data-Mappings-Language-Emotion framework to different and far more complex datasets than those described in Chapter 3 should prove its usefulness in a range of compositional settings. Furthermore, the combination of visual and musical representation of the data presented a potentially interesting new path for data representation.

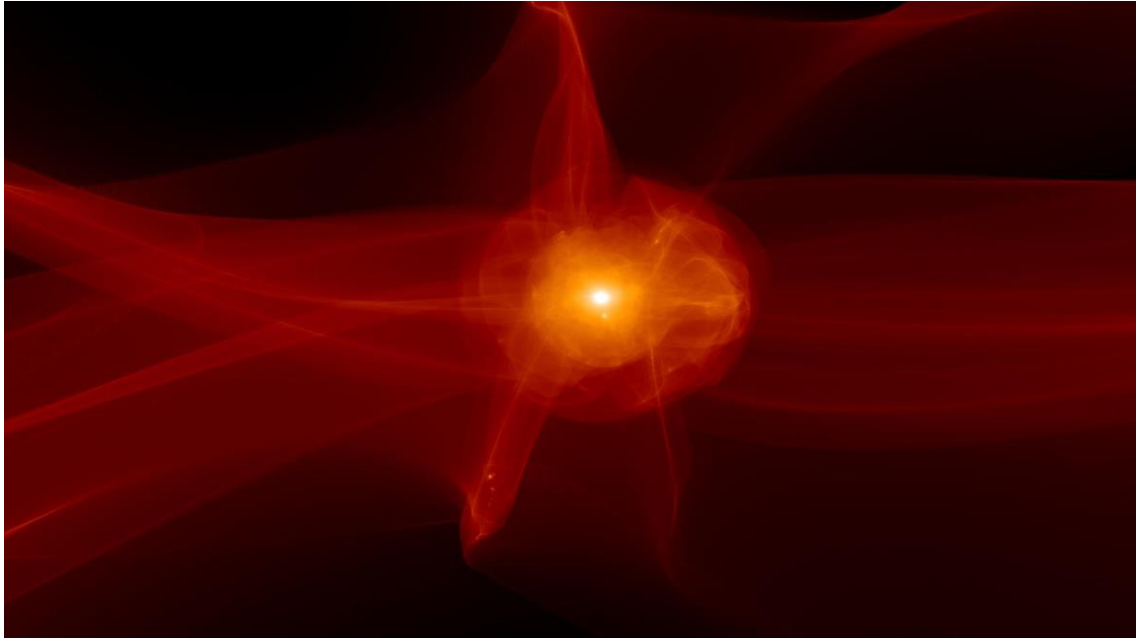

Fig. 4.1: Visualisation of a warm dark matter halo simulation. Visualisation by Ralf Kähler and Tom Abel, simulation by Oliver Hahn and Tom Abel (Kähler et al., 2012).

4.1.2 Dark Matter

Dark matter does not emit or absorb radiation: it cannot be seen or heard (CERN, 2012). Rather, the existence of dark matter is perceived through its effect on the baryonic (visible) matter. 95% of the universe should be made up of dark matter (27%) and dark energy (68%) in order to justify its behaviour according to the laws of physics (NASA, n.d.). The gravitational forces in the universe are far too large if only baryonic matter were acting on them, so the existence of dark matter and dark energy would explain these gravitational effects. The comparison of dark matter particle simulations with observational data, such as galaxy surveys, is used to test these simulations (Kähler et al., 2012, p. 1). Kähler et al.'s novel visualisation method produces less smoothing in the image; this also reduces potential artefacts which can introduce erroneous information in a visualisation (Kähler et al., 2012, p. 8).

4.1.3 Challenges

The sonification of dark matter throws up some interesting problems. The datasets describing the behaviour of dark matter are very large and complex; their handling is a challenge. Because dark matter cannot be perceived, there is no intuitive linkage between data and possible sound mappings. As we will see, we might associate the sound world of science-fiction movies to the topic of dark matter, as we associate particle physics to space exploration. This association can be harnessed for information transmission, as described in 4.4.

The Sonification of Dark Matter combines visual and aural displays of data; their combination offers opportunities and challenges for the information transmission. It is important to understand the human perception visual and aural cues and how they mutually relate in order to design displays which complement each other in information transmission. The two senses can have 'cross-modal' interactions that alter our perception (Marks et al, 2003); for instance, a study found that a single light flash accompanied by two beeps was perceived as two flashes (Shams et al., 2001).

Finally, collaboration with particle physics specialists is necessary to access data, technology and knowledge concerning dark matter simulations. The collaborative process is examined to identify best practice and approaches for further sonification projects. Challenges can arise both from the composer's lack of topic-specific knowledge and the scientists' misunderstanding of the sonification process.

4.1.4 Compositional Process

The composition of *The Sonification of Dark Matter* had a pronounced exploratory element as a variety of parameters and mapping were produced before empirically determining which would be suitable for a 'performance version'. In fact, the composition process contributed to the exploration of the effectiveness of different data-to-sound parameters, contributing to the classification of 'primary' and 'secondary' parameters. The different mappings were chosen either for their data transmission or aesthetic potential, and combined to produce a 'complete' musification. Some aesthetics liberty was taken in adding some sound design to underline certain patterns or trends in the data.

4.2 Data

Data were provided by Ralf Kähler from the Kavli Institute. The three simulations used for sonification were 'Dark Matter Halo' (Fig. 4.1), 'Dark Matter Streams' (Fig. 4.2) and 'Dark Universe: LSS' (Fig. 4.3). The 'Dark Matter Halo' visualisation shows a so-called dark matter halo which consists of about '1000 gravitationally bound regions' that each host a separate galaxy; these are represented as bright yellow and white (Kähler and Abel, 2012). Some of the movement that can be seen in this visualisation is due to a change of camera position; the camera rotates horizontally around the evolving halo formation. 'Dark Matter Streams' shows dark matter galaxy filaments which are gravitationally bound galaxies. These streams on universe surveys 'are interconnected and form a network, with voids largely devoid of galaxies comprising the region between the filaments' (Bharadwaj et al., 2004, p. 25). Again, the densest regions are represented by bright yellow and white whereas the less dense regions are assigned a range of blue. Finally, the 'Dark Universe: LSS' visualisation shows the large-scale

structure of the universe. The denser zones are shown in bright yellow and white whereas the less dense zones are shown in shades of black and grey. This visualisation also has some horizontal camera movement which brings some yellow clusters closer into view; this can be mapped as a spatialised musical gesture.

The data sets are very large; the 'Warm Dark Matter Halo' simulation, for example, tracks 17 million particles which results in over 100 million tetrahedra per time step; another simulation discussed by Kähler et al. contains 'about 134 million particles, resulting in about 804 million tetrahedra, respectively 3.2 billion triangles' (Kähler et al., 2012).

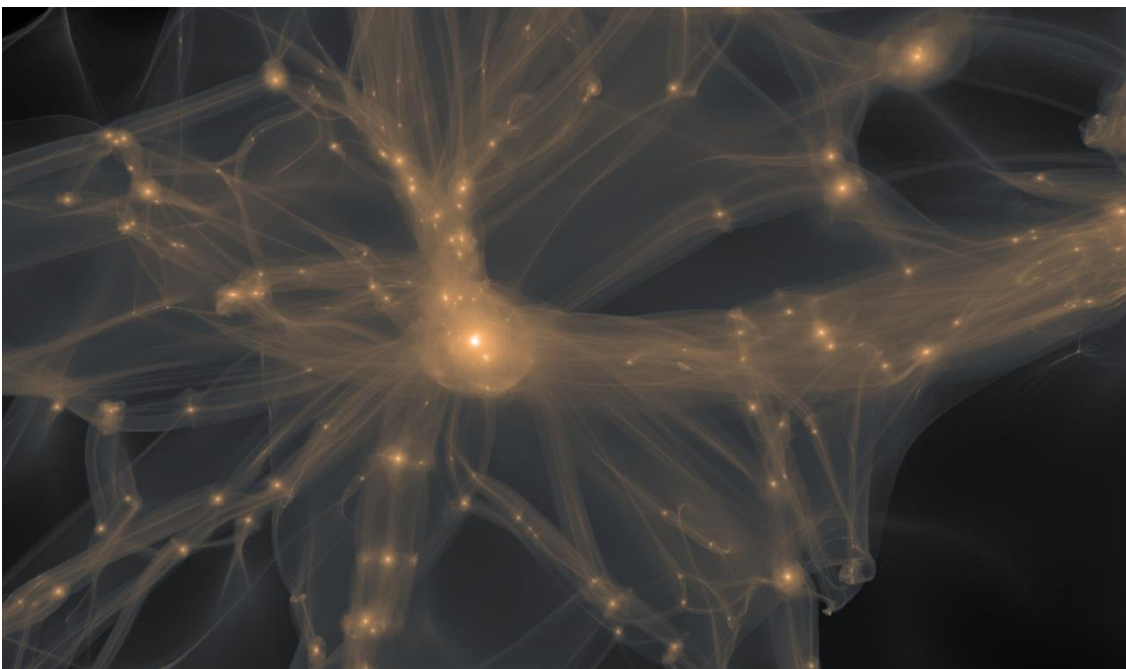

Fig. 4.2: Visualisation of a dark matter streams simulation. Visualisation by Ralf Kähler and Tom Abel, simulation by Oliver Hahn and Tom Abel (Kähler et al., 2012).

4.2.1 First Approach: Data Files

The approach initially applied to the data files consisted of filtering and compressing them as to render them manageable and understandable. This method should then reveal interesting patterns or features in the data which could

be highlighted through sonification. Ideally, the information transmitted in the aural display would complement the visual display as it would reveal features that are not perceived in the visualisations.

However, it soon became obvious that careful handling of the data was needed because of their size and complexity, the presence of low-level data in the sound mapping would result in an incomprehensible and very dense sonic representation. Thus, the reduction of data points was unavoidable. The format (32-bit binary) and size of the data files presented a challenge for the technology available for the project. Furthermore, the datasets proved very difficult to handle without more specialised knowledge.

Similar challenges have been faced in the past by composers creating particle physics data musifications: Rhoades describes almost abandoning the project because of the non-temporal nature of the data (Rhoades, 2014). In fact, the temporality of dark matter can be an issue when creating visual or aural displays. Sound is inherently temporal although some sonification methods like model-based sonification attempt to circumvent this issue (Hermann, 2011). The visualisations used here have some camera movement, mainly horizontal panning, which introduces a temporal element to them. We can assume that the scientists made this visual choice to increase the interest of the visualisation and to offer different perspectives on the phenomenon shown. This choice is useful in the context of the subsequent sonification as its temporal evolution also justifies the evolution of the musical material.

When using non-temporal data for Parameter-Mapping sonification, a timeline or narrative must be created. Adderley and Young's installation *Ground-Breaking* sonifies Sahelian soil samples, which have no temporal information. Their

solution is to 'linearize [...] the data so that it has a timeline, but they acknowledge that this introduces decision-making which is focused on 'a desired or predicated outcome'. They describe this as the 'antithesis of scientific investigation [which] may reveal ideologically transparent preconceptions about music' (Adderley and Young, 2009, p. 408). The issue described here applies to all data representation, visual or aural, as decisions are taken as to how to make the dataset perceivable. In introducing a temporal element, we must remain careful of not skewing the data for the purpose of the musical aesthetics or the meaning imposed upon it.

Issues in the collaborative process appeared already at the data collecting and handling stage. The scientific collaborators struggled to understand my requirements and difficulties in dealing with the datasets. Their lack of understanding of the sonification process meant that they did not understand the necessity for appropriate data for sonification, or what such a dataset would look like. The conclusion reached was that a different approach was necessary as the data could not be dealt with appropriately to progress to the stage of mapping them to sound, and the scientific collaborators did not understand the demands of the project.

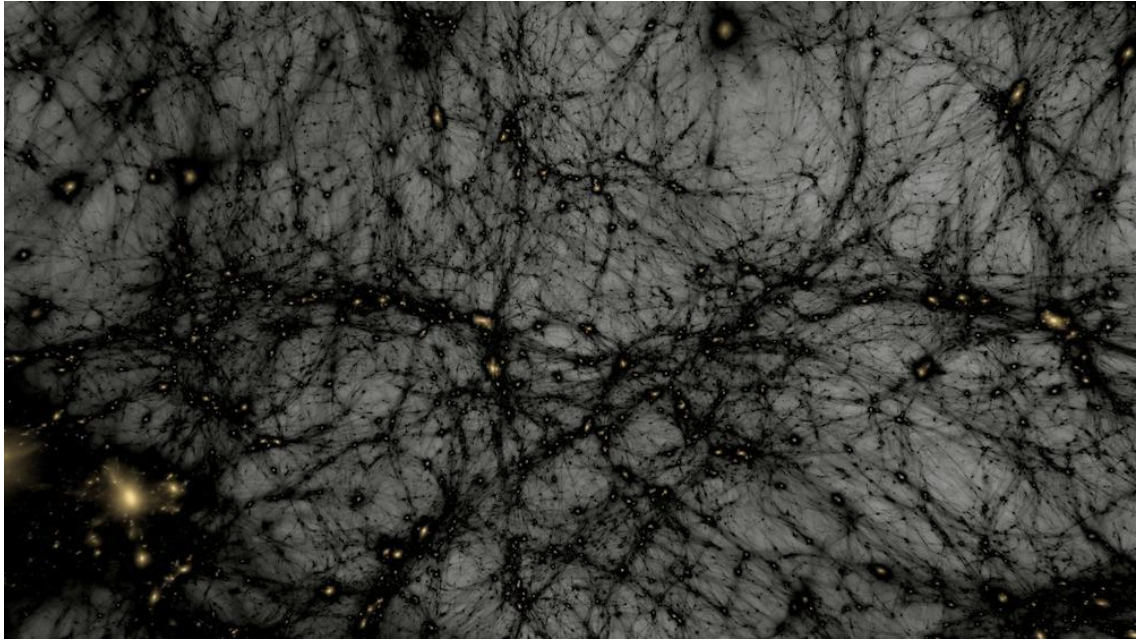

Fig. 4.3: Visualization of a simulation of the large-scale structure of the universe (LSS). Visualization by Ralf Kähler and Tom Abel, simulation by Oliver Hahn and Tom Abel (Kähler et al., 2012).

4.2.2 Second Approach: Data Extraction from Visualisations

Due to the restricted timescale of the project – with the premiere already scheduled - a different and non-collaborative approach to the data was needed. This approach consisted of using the visualisation as representations of the data, from which a filtered version of the data should be extracted. The spatial tracking of the dark matter particles reveals their spatial position, density and movement.

Max 7 is used to analyse the visualisations and find higher-level relationships patterns in the data. Salient visual features are highlighted by adjusting the parameters of brightness, saturation and contrast. The spatial tracking of the selected features is possible by the sub-division of the matrix into six smaller matrices; the density of the particles in each matrix indicated their movement.

The analysis produces filtered data that can be used for mapping. This reduced dataset contains higher-level information because it gives the spatial position of the particles. This 'long way around' approach (Fig. 4.4) solves two issues

concerning the handling of the large datasets. On the one hand, it circumvents the difficulty of working with an unfamiliar format and extremely large files. On the other hand, it allows filtering and compressing the data in a way that can be sonified with the same software. Both processes were necessary because it would have been nearly impossible and pointless to sonify the whole data files.

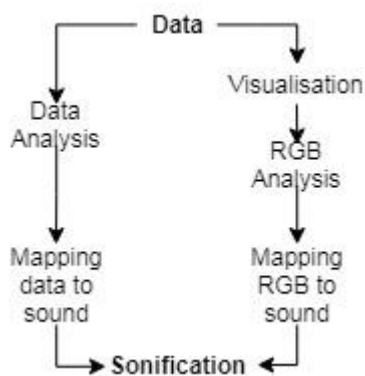

Fig. 4.4: Process from data to sonification. The left-hand side shows the typical method for data sonification and the right-hand side the modified method needed to deal with dark matter simulation data.

4.3 Mappings

4.3.1 Visualisation Mappings

The data are extracted from the visualisation of the original datasets. The visualisation process must be understood to choose appropriate images for sound mappings. In fact, the sonification process is analogous to the visualisation process where the particle density is represented by different colours chosen by the visualisation designer. Similarly, the particle density and its assigned colour determine the mapped sound. The visualisation process involves some artistic choices which are analogous to the compositional method of assigning sound to data parameters; dark matter is invisible so its representation in colour is artificial.

Higher-level relationships are sonified; these visually translate as 'objects'. Examples of objects are the halo in 'Warm Dark Matter Halo', the streams and clusters in 'Dark Matter Streams', and the streams and clusters in 'LSS'. The higher-level data of these objects are the size of a dark matter halo ('Dark Matter Halo'), spatial particle concentration and distribution ('Dark Matter Streams'), and the movement of structures through space ('LSS').

4.3.2 Primary and Secondary Parameters

While the objects described were chosen as salient features in the data, other data aspects are also important to get 'the full picture'. In complex datasets like these, some data parameters are more cognitively important than others. The data can be divided into *primary* and *secondary data parameters*.

The same concept can be used for sound mappings by defining *primary* and *secondary sound parameters*. Primary and secondary data parameters can therefore be mapped to primary and secondary sound mappings. 'Primary cues' are attributed to sound parameters to which we are particularly sensitive and capable of perceiving even small changes. These sound parameters could include 'pitch, tremolo rate, rhythm and attack time'. 'Supporting auditory cues' such as 'volume, pan position, number of harmonics or envelope shape' are more difficult to perceive accurately (Ballora, 2014, p. 31). However, supporting auditory cues can help differentiate primary cues. Ballora gives an example: data points in an increasing pattern may produce a primary cue of ascending pitches, but these pitch changes may be complemented with corresponding changes in harmonic content and/or pan position' (Ballora, 2014, p. 31). This is possibly because pitch and rhythm provoke a neurological response, which make them perceivable in a more precise manner (Large, 2010). A survey of sonifications

shows that pitch is the most-used sounds parameter (23.8%), followed by loudness (15.2%), duration (10.1%; we use rhythm rather than duration) and spatialisation (9.5%) (Dubus and Bresin, 2011, p. 15). This supports our empirical choice of sound mappings: pitch and rhythm are primary sound parameters, and volume, stereo panning and degree of randomness are secondary sound parameters.

4.3.3 Hierarchies in Music

The idea of primary and secondary data and sound parameters is not only useful for sonification design, but also in musical composition. A hierarchical structure of compositional parameters contributes to the overall musical structure. A well-known hierarchy in music is the tonal hierarchy which determines which notes are most likely to be heard according to the tonality of the music (Krumhansl and Cuddy, 2010). While some musical connotations are widely understood, for example modes and their associated emotions, the emotional effects of other musical parameters are not as well known (Hunter and Schellenberg, 2010, p. 156). Even so, we can argue that the listener's emotional response to music is elicited by more parameters than those they might consciously hear. Similarly, primary and secondary sound parameters are heard by a listener but not necessarily consciously perceived while they still contribute to the sonification. The application of a parameter hierarchy can therefore be beneficial in designing a musification, as a way of translating data structures to musical structures.

The data parameters are of a higher-level nature when the relationships between the data points are explored rather than the data themselves. Gresham-Lancaster describes this as 'second order sonification', 'the application of time-bound algorithmic processes that are driven by sets or clusters of a data set' (Gresham-

Lancaster, 2012, p. 210). He states that a more 'abstract level of sonic realization' can take advantage of 'more sophisticated algorithmic structures' and 'frame the output in larger musically formal structures'. He describes 'second-order sonification as opposed to 'first-order sonification' which is the 'direct linkage process between the data itself and some technique for rendering it in a sound space'. Gresham-Lancaster's idea supports our concept of a musical hierarchy in sonification as musical and data mapping processes take place on different levels.

4.3.4 Mappings: Experimental Approach

Many data to sound mappings were tried and evaluated empirically during the sonification process. The empirical findings aligned with the literature on the perception of musical parameters, as discussed above. The primary and secondary parameters were determined from the empirical and theoretical results. We will describe some of the mappings that were retained for the final musification.

4.3.5 Mappings: Warm Dark Matter Halo

The salient objects identified in this visualisation are the inner and outer halos of the dark matter galaxy; they are represented in white and yellow respectively. The size of each determined the frequency, amplitude and spatialisation of a sine wave. The larger the halo is, the louder and sharper it sounds. Each halo also determines the pitch and frequency of triggering of a sample of a piano attack. The larger the halo is, the sharper and more repeated the piano sample is. For effect, the piano sample is first heard when the inner halo appears. This sonically underlines the event when the galaxy is formed.

4.3.6 Mappings: Dark Matter Streams

The piano attack sample is played by a groove~ object which plays it back while modifying its parameters. The number of galaxies in the dark matter of streams (shown by the amount of yellow in the image) determines the frequency of triggering of the sample as well as its pitch shift. Because this value changes rapidly, the pitch shift occurs during each repeated sample. The number of galaxies also determines the tempo of a percussive pattern which is panned horizontally depending on the concentration of galaxies on each of the image sub-divisions (divided into six matrices).

4.3.7 Mappings: Dark Universe

The density and position of the galaxies in the large-scale universe determines the frequency and panning of drones created by additive synthesis. Some sound design is applied to the drones to highlight the spatial trajectories of some galaxies. When a galaxy system appears closer to the audience, the amplitude of the drone has been augmented in order to create a proximity effect similar to the Doppler Effect.

4.4 Musical Language

We have shortly discussed already the issue of the choice of a musical language or sound world which are suitable to represent 'the sound of dark matter'. Dark matter itself emits no sound. Possible connotations of dark matter relate to the technology used to detect it, suggesting synthesised or industrial sounds. The most common association made with the 'sound of dark matter' is with music from the 'science-fiction' genre. While we have found this to be a common first idea that comes to mind, there is a danger of working with a clichéd concept.

Music and sound effects used in science-fiction movies have long been associated with the sounds of electronic instruments and synthesisers. This association owes much to the timeframe of early science-fiction movies; space exploration programmes and music technology were rapidly developing, and this is reflected in the movies. Pinch gives the example of Louis and Bebe Barron's soundtrack to the movie *Forbidden Planet* which used 'one of the first commercial tape recorders available in the US' (Pinch, 2014). The theremin was also popular because of its 'unearthly' sound. In fact, because sound does not exist in space, the soundtrack of science-fiction movies has often created imagined soundscapes that have become associated with the genre (Wierzbicki, 2014). Elements of 'science-fiction music' include the use of oscillators and other electronic circuits and synthesisers, buzzing and bleeping sounds representing machines, radio interference, and so on; a soundscape designed to sound 'other'.

The use of the musical tropes of science-fiction in the sonification of dark matter is ambiguous. Associating the sound of dark matter to this electronic other worldly soundscape is almost intuitive to someone familiar with science-fiction. Dark matter is not perceivable and is little understood by the general population; its ties to science-fiction are obvious. Furthermore, the use of synthesis techniques for sound production is practical in the field of sonification, particularly when using software which easily implements sound synthesis. Conversely, the use of tropes carries the possibility of distracting from the subject matter as the listener falls back on learnt connotations. Their use can be justified but must be carefully considered in the interest of the musical result.

The sounds used in this project are reminiscent of 'science-fiction music' because they include many synthesised sounds. Some audience members described the

music as 'weird' and 'like Dr. Who' thus confirming the connotations described above.

4.5 Emotional Content

The emotional content of dark matter data might not be obvious because its sonification is not 'source-bonded' (Smalley, 2007, p. 38), as there is no relationship between phenomenon and sound. As previously discussed, there is no possible direct linkage between the subject matter and its sound. Still, some connotations appear, mainly through the association with science-fiction movies. The question of the emotional content must be approached differently. Rather, we must ask what the musification should transmit to the audience, and how it will contribute to their audio-visual experience. We know that the experience of a silent video is enhanced by adding sound. The function of the sonification in this case is more functional. By transmitting information in a way that informs the listener about dark matter, and has an aesthetic value, it achieves the aim of providing an environment for information transmission.

The performance context of *Sonification of Dark Matter* also determines some of the purpose of the musification, and, therefore, the emotional content attached to it. Three performances took place in the Immersive Vision Theatre at the University of Plymouth. The dome is in the shape of a half sphere which allows for a wrap-around projection; it also has an array of ten loudspeakers on the walls, although no spatial diffusion beyond a stereo set-up was possible. This immersive venue favours a musification with dense musical textures with spatialised gestures.

4.6 Performance

Sonification of Dark Matter is a 17-minute audio-visual fixed media performance. It opens with the silent visualisations to familiarise the audience with the concept of dark matter and demonstrates the need for accompanying sound. Then, some of the individual sound mappings on each of the videos are played to make the compositional process more explicit. Finally, the 'complete' version is shown, which includes the final chosen mappings and some sound design effects. This approach reveals aspects of the process of musification while enabling the audience to engage with complex ideas around dark matter.

The premiere of *Sonification of Dark Matter* took place at the Peninsula Arts Contemporary Music Festival from 26-28 February 2016 and was repeated over the course of the three-day festival.

The project received some media attention with articles in the *Observer*, the *Independent*, *Physics World* and *Nature Physics*. The timing of the press release coincided with the discovery of gravitational waves, which contributed to the surge in interest.

4.7 Collaboration

We have described the need for collaboration with a specialist when dealing with complex data such as dark matter simulation data. This is because of the knowledge and technical skill required to understand and handle the datasets. In fact, the description of the Data-Mapping-Language-Emotion framework in Chapter 3 amply illustrates the necessity of excellent data understanding and knowledge in the sonification process. The involvement of the creators of the data in the process is therefore a necessity to the project.

4.7.1 Types of Collaboration

The term collaboration is often used as an umbrella term for shared working relationships which are not necessarily collaborations (Taylor, 2016, p. 566). We should clearly define the shared working process desirable for sonification design. Taylor describes four types working relationships according to the criteria of ‘hierarchy in decision-making and division of labour in artistic imaginative input’ (Taylor, 2016, p. 569). The resulting relationships are *hierarchical working*, *co-operative working*, *consultative working* and *collaborative working* (Table 4.1). Collaborative working implies that the participants are involved in all tasks and decision-making; working relationships termed collaboration are often not true collaborations as we will see below. In the musification process, we might expect a hierarchical or consultative working relationship: the scientist only provides scientific insight to support the composer’s decisions, or takes some decisions but leaves the ultimate decision-making power to the composer.

Tab. 4.1: Forms of working relationship (Taylor, 2016, p. 570).

		Hierarchy in decision-making	
		Yes	No
Division of labour (separation of tasks) in imaginative input	Yes	<i>Hierarchical working</i> Tasks are divided between the participants. One or more participants decide on the contributions made.	<i>Co-operative working</i> Tasks are divided between the participants, but decisions-making is shared.
	No	<i>Consultative working</i> The participants contribute to the same task or tasks. One or more people decide on the contributions.	<i>Collaborative working</i> The participants share both the tasks themselves and the decisions on the contributions.

4.7.2 Examples of Working Relationships in Sonification

The term collaboration is also commonly used in relation to working relationships for sonification projects. A short survey of such projects reveals that these are rarely truly collaborative, as described above. Particularly, the particle physics data sonification projects are often hierarchical, as scientists only provide data and information but take no further part in the process. This is the case for two projects carried out at CERN (Cherston et al., 2016; Vogt et al., 2010). The scientists' simultaneous curiosity for sonification and lack of knowledge about it is described (Vogt et al., 2010, p. 103); but their contribution is limited to the provision of data and permission to use it (Cherston et al., 2016, p. 1652). The division of labour is therefore clearly distributed and the compositional decisions are solely taken by the composers of the project; this is a *hierarchical* working relationship.

Pilkington's *Touch the Stars* sonifies data received by a radio telescope at the Jodrell Bank Observatory (Pilkington, 2013, p. 34). During the live performance, an operator directs the trajectory of the telescope to determine the incoming data. Therefore, the scientist has decision-making power in the performative aspect of collecting the data, in the knowledge that it changes the resulting sound; for example when crossing the Milky Way (Pilkington, 2013, p. 37). I would argue that there is still a clear division of labour between scientist and composer as the latter has produced the algorithm and interface to complete the sonification process. *Touch the Stars* is thus an example of a *co-operative* working relationship.

Natasha Barrett and Karen Mair provide an example a *consultative* working relationship through the project *Aftershock*; the scientists provide 'source data for

sonification, some actual sounds and inspiration for the recording and production of input sounds' (Barrett and Mair, 2014, p. 4). The compositional choices are ultimately determined by the composer, but the scientists provide advice at all stages of the process.

We have identified some working relationships which use the term collaboration in their documentation, but we can argue that the term has been incorrectly applied. A true collaborative relationship is difficult to achieve because it is still unusual for working parties to engage in the sonification process in such a manner. Additionally, the actual working relationship is rarely explicitly discussed and must rather be deduced from the resulting documentation. Adderley and Young's project *Ground-Breaking* has been identified to be truly *collaborative* because both authors (a scientist and a composer) appear to have been involved equally at all stages of the sonification process (Adderley and Young, 2009). Although never explicitly stated, we can deduce from the article that both analysed soil samples, determined a narrative and musical language for the sonification, and produced the installation.

This short review highlights that more collaborative working relationships appear when the number of participants is low. An increasing number of participants can obstruct collaboration because it becomes difficult to involve them equally in all tasks and decision-making processes. To conclude, a collaborative process towards a sonification project requires foremost that all parties understand the sonification process and are willing to engage in it. However, the nature of this relationship will also be strongly influenced by the number of participants, as well as their attitude and the knowledge and skills that they can contribute.

4.7.3 Working Relationships in *The Sonification of Dark Matter*

The 'collaboration' on *Sonification of Dark Matter* was a clearly *hierarchical* working relationship. The data files and accompanying information were provided by the scientists with no expectation of further involvement in the sonification process. Attempts to encourage further input from them on mappings, for example, were fruitless. When asked about ideas for mappings and musical language, they made it clear that they did not wish to contribute as they were not the 'experts' in this field. The aim to build a consultative working relationship therefore failed. This can be attributed to a lack of understanding about the sonification process and the working relationship which I wished to establish. Our sonification framework shows that all stages of the process are inter-related and that their knowledge of the data would have been beneficial to all aspects of the process. However, because of the view that they as dark matter specialists they were responsible for providing the data, it remained a hierarchical working process.

For this project, a true collaboration might have produced more interesting results than the hierarchical working, as combined knowledge and skills could have been applied to all tasks during the sonification process. Keefe et al. claim that 'artists routinely provide a unique source of visual insight and creativity for tackling difficult visual problems' (Keefe et al., 2005, p. 18), and that they could have key roles in working closely with scientists to design novel visual techniques for exploring data and testing hypotheses' (Keefe et al. 2005, p. 23). Conversely, this project has shown the potential for insight from scientists into the creative process. A possible example of this might be input into interesting elements in the dataset that should be represented, as well as ideas around the best manner to do so.

De Campo describes the need for a common 'exploratory strategy' (De Campo, 2007, p. 1):

When collaborations on sonification for a new field of application start, sonification researchers may know little about the new domain, its common types of data, and its interesting research questions; similarly, domain scientists may know little about sonification, its general possibilities, and its possible benefits for them. In such early phases of collaboration, the task to be achieved with a single particular sonification is often not easy to define clearly, so it makes sense to employ an exploratory strategy which allows for mutual learning and exchange. Eventually, the interesting tasks to achieve become clearer in the process.

4.7.4 Challenges of Collaboration

A true collaborative working relationship can be difficult in musical creation. To share the decision-making process means to share the compositional authority.

Hayden and Windsor (2007, p. 31) describe the issue:

However motivated to enter into collaborations he or she may be, there may be tacit or explicit resistance to the idea of giving up creative control. Moreover, a focus on collaboration may move the working style away from a tendency to prioritize the output of composition towards a desire to reflect on and improve the processes which come prior to this.

The implicit idea that the composer must have the authority over the compositional process might have influenced the collaborators' reticence to give more input. If each specialist must remain in their domain, it creates the feeling that they were not able to provide anything interesting to the sonification and creative process.

Collaboration in musical creation has often been discussed in relation with collaborations between composers and performers (Fitch and Heyde, 2007; Goves, 2010), dancers (Stiefel, 2002), lyricists (Goves, 2010), and so on. These represent working relationships between specialists of similar or at least sympathetic disciplines. While these relationships are not necessarily simple, one would expect some common knowledge and intention as a starting point between the collaborators. Yet, the issue of compositional authority and boundaries

between participants' roles are present even when composers collaborate with other agents (Fitch and Heyde, 2010, p. 73). Additionally, the process can be far longer when involving collaborators than if working in isolation (Fitch and Heyde, p. 93). Consequently, the usefulness of collaborative working relationships can be questioned as they are time-consuming and fraught with difficulties.

We could argue that this traditional or romanticised view of the composer does not apply when creating a musification because it necessarily functions on a functional-artistic spectrum. The compositional process and authority is altered because of the introduction of affordances related to the data sonification. The need for additional knowledge and considerations around data and their source mean that the composer must necessarily open their process up to external influences. The question of the usefulness of the collaborative process is easier to resolve; the actual process becomes different though. Furthermore, the working relationships in sonification projects have rarely been examined explicitly.

4.7.5 Criticisms of Collaboration

The discussion in Chapter 2 showed the scepticism and criticism aimed at sonification, both from the scientific and musical communities. Similarly, collaborations between artists and scientists (also named 'sci-art') are subject to reticence. CERN's Collide program²¹ chooses an annual Artist in Residence who produces work inspired by their stay at the Laboratory, but the work is not necessarily directly linked to the research at CERN. The work produced in this context has sometimes been harshly criticised for prioritising attention-grabbing aesthetics over information transmission or an explanation of scientific phenomena. Of Ryoji Ikeda's installation *Supersymmetry*, a review in the

²¹ <http://arts.cern/collide>

Guardian claimed that it was ‘a lot of sound and light, signifying nothing’; Jones goes on to ask whether we should stop ‘expecting artists to understand the complexities of science’ (Jones, 2015)? In his article ‘Only great work can really justify sci-art collaborations’, Ball suggests that the ‘best, richest work tends to emerge from long-term collaborations, and requires patience, openness, mutual sympathy, and a tolerance of mess (perhaps literally). In the end, the only way to answer the critics is to be too good to ignore’ (Ball, 2018). His proposed ‘solutions’ to the lack of quality in sci-art work reflects the challenges identified above. He identifies the need for understanding of the work process between the science and the arts collaborators, and the willingness to engage in a process without the expectation of a finished product.

4.7.6 Potential Solutions for Problems in Collaborations

We have seen that true collaborations are difficult to establish. A shared working relationship in which all participants are comfortable with and willing to share all tasks and make decisions on all aspects of the project necessitates voluntariness, well-defined roles and status, an appropriate size and an efficient *modus operandi*. Members of a group, who have chosen to be part of it might be more willing to participate in it (Vernelle, 1994, p. 12); they must therefore be carefully chosen and perhaps convinced to join. When their involvement is not voluntary, as is the case for *The Sonification of Dark Matter*, they appear far less willing to cross the boundary of their own discipline and contribute to the decision-making process. Pre-conceived notions of the roles and status of the members of the group can hinder the participation in all the activities of the project as they do not consider themselves capable of or responsible for certain tasks. The size of the collaboration is critical; more participants means a greater number of potential

ideas, but also a more time-consuming creative process²². Large groups also encourage negative side effects that are detrimental to the creative process, such as ‘groupthink’ – ‘the tendency to use inadequate decision-making procedures in groups because of the group’s tendency to seek concurrence and disregard risk’ (Goethals and Darley, 1987, p. 38) - or social loafing – the ‘sizeable decrease in individual effort when performing in groups’ (Latané et al., 1979, p. 822). A relatively small group, such as a dyad or a triad, thus seems appropriate for a sonification task where each participant interacts with and learns from each other.

The concept of ‘group mind’ or ‘transactive memory systems’ can be useful when discussing the creation of a successful inter-disciplinary sonification collaboration. This theory posits that ‘a set of individual memory systems’ (Wegner, 1987, p. 186) can communicate to create a transactive memory where members of the memory system can hold knowledge for other members of the group. A family unit, for example, might be a transactive memory system as it holds all necessary knowledge to run a household, but no individual member holds all of the knowledge. The group mind allows individuals to learn about each others’ domains of expertise while accepting responsibility for their own knowledge (Wegner, 1987, p. 197). Wegner (1987, p. 196) states that this memory system can of course produce errors but also ‘useful creative products’. When applied to a group including a composer and two dark matter scientists, for example, the group mind would allow them to gain knowledge about each others’ domains of expertise without the necessity of duplicating the individuals’ knowledge. As the members of the group are aware that another member holds a memory of the

²² The number of possible relationships in a group of size N is given by the following equation (Kephart, 1950, p. 548): $PR = \frac{3^N - 2^{N+1} + 1}{2}$. For a group of two, there is only one possible relationship whereas for a group of seven there 966 possible relationships.

knowledge they require, they can access a transactive memory system. A successful group mind requires the correct encoding, storage and retrieval of knowledge for each individual. In practice, this might translate to the use of a common vocabulary for musical and scientific terms, individuals' responsibility for holding certain knowledge and the possibility of accessing the needed knowledge from the relevant individual.

The discussion above highlights the importance of carefully choosing the members of a collaboration. They do not need to hold all the musical and scientific knowledge that will be applied to the sonification if they can work within a transactive memory system. Rather, the members of the group require the willingness to participate and take a variety of roles in the project, while trusting that they can learn from and help other collaborators.

4.8 Scientist-Composer

Conceptions around the compositional authority, the sonification process, and participants' roles have prevented a potentially more interesting collaborative working relationship in this project. A hierarchical working relationship was established and eventually produced a good product – a musification – which however presented some compromises; the use of image analysis rather than work on the raw data is an example. This way of working puts emphasis on the composer as they take a bigger share of the work involved while they also retain the compositional authority. They are therefore also obliged to become proficient on a wider range of the artistic-functional spectrum. The term 'scientist-composer' becomes necessary to describe the role performed by the composer of the musification.

The 'scientist-composer' has been described as 'a composer who engages in scientific research and development to compose a piece, or furthering research into new ways of composition. They are primarily a composer and rely on scientific research solely as 'a point of reference' (Leamy, 2008); a practice-as-research methodology can be suitable as it combines the composer's knowledge and skills with a scientific conceptual framework. The scientist-composer must occupy a position at the centre of the artistic-functional spectrum. It is however virtually impossible to achieve an equal amount of expertise in both fields and Leamy specifies that they are still primarily a composer. Only some composers can become scientist-composers because each dataset used requires a specific knowledge and range of skills. This can be impractical and time-consuming for any composer wanting to write a musification.

Working as a scientist-composer can be an opportunity for those with no institutional support or relevant networks to engage in musification work. The data or working methods need to be adapted to the situation of creating in greater isolation, for example by using freely available data and gaining an understanding of the subject matter through relevant literature. As already discussed, operating as a scientist-composer does not exclude the possibility of seeking some external input in the form of knowledge or feedback; it does however emphasise that the labour division is such that the scientist-composer takes the largest share of the sonification process.

Finally, the discussion on the concept of the scientist-composer might provide one answer to the question of *why* a composer might wish to write a musification. The sonification process demands a certain dedication to the chosen data as well as the process in itself. It can therefore be used for personal development, as the

process is in itself informative for the composer. It can also be used to find new creative inspiration methods which might lead to an artistic output. To conclude, the interest of engaging with musification for the composer can be as much about the personal development as the public output, as much about the process as the result.

4.9 Conclusions

This chapter has discussed the compositional process of *The Sonification of Dark Matter*. It describes the challenges and opportunities of using very large and complex datasets, and the solutions found to deal with them. We have also discussed the audio-visual aspect of the project, which adds novel affordances to the musification process.

Primary and secondary data parameters have been defined and used to translate complex datasets to primary and secondary sound parameters. In fact, existing musical hierarchies can be useful to apply to data hierarchies as a way to transmit layers of information. The difficulty of Parameter-Mapping sonification of non-temporal data has been discussed. The solution often consists in creating a timeline through some data handling, but in this case the camera movement in the movement creates a temporal element and an interesting opportunity for sound spatialisation.

The composition process has highlighted issues around collaboration with specialists from other disciplines. The definition of collaboration has been discussed through examples of self-defined 'collaborations' in sonification; in practice, different types of shared working relationship are applied. Consequently, challenges of collaboration and proposed solutions are presented.

Finally, the concept of the scientist-composer is introduced to describe the status of a composer with sufficient scientific knowledge to carry out all the tasks of the sonification process. It is identified as an opportunity for composers who work in isolation to engage in musical 'sci-art' and gain scientific knowledge.

Chapter 5

The Voice of the Sea: Echoing our Environment

,Tradition ist nicht die Anbetung der Asche, sondern die Weitergabe des
Feuers.'

'Tradition is not the worship of ashes, but the preservation of fire.'

Gustav Mahler

This chapter discusses the piece *The Voice of the Sea* which uses the musification of real-time buoy data. The piece is situated in the tradition of musical representation of natural and human soundscapes.

The piece can be found on the accompanying CD (see Appendix 2) as *The Voice of the Sea*.

5.1 Overview

The Voice of the Sea was commissioned for the Peninsula Arts Contemporary Music Festival 2017. The piece uses the sonification of a real-time discrete data stream from a buoy near Looe in South-East Cornwall (Fig. 5.1), sound samples and live sound synthesis. The performer also makes event and sound-based decisions during the piece, so that each performance is unique.

The creation of the piece was supported by some specialists who provided the knowledge and access required: Emerald Siggery from the Plymouth Coastal Observatory, Jason Sadler from the University of Southampton, and Travis Mason from the National Oceanography Centre. The details of the working relationship with them will be further discussed in 5.7.

The Voice of the Sea was premiered on Sunday 26 February 2017 in the Crosspoint space of the Roland Levinsky building at Plymouth University; a second performance took place at the House building at Plymouth University during the *Balance/Unbalance* conference on 21 August 2017. Both performances used a stereo set-up, but the premiere was played on a quadrophonic system while the second event used two speakers only. An 8-channel speaker set-up was used for a performance with the *Huddersfield Immersive Sound System (HISS)* at the University of Huddersfield during the *BFE/RMA Research Students' Conference* on 5 January 2018. Finally, it was performed with real-time visualisation from Coral Manton at the KARST gallery in Plymouth on 8 September 2018.

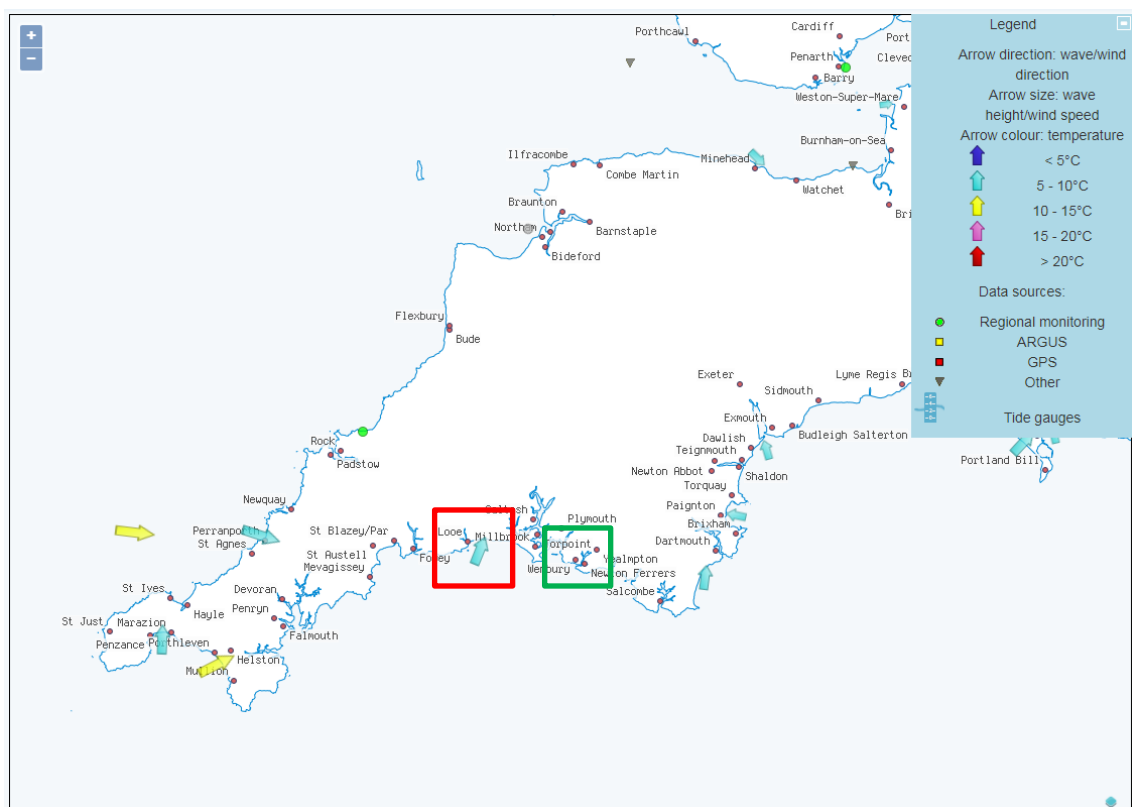

Fig. 5.1: Locations of the Looe buoy (red square) and Plymouth (green square), as shown on the Channel Coastal Observatory website²³.

²³ http://www.channelcoast.org/data_management/real_time_data/charts/ (accessed 10 January 2018)

5.1.1 Compositional Process

This piece uses live data which is mapped in real-time, which introduces an improvisation element into the compositional process. Different 'modules' which produce certain data-to-sound mappings are defined but need to be turned on and off during the performance. The mappings were chosen to sonically represent a variety of sea states, from calm to stormy. The modules use synthesises as well as recorded marine sounds to recreate a marine soundscape.

5.2 Data

The data are received from a wave buoy at Looe Bay (50° 20.33' N 004° 24.65' W) which is maintained by the Channel Coastal Observatory (with Plymouth Coastal Observatory as their South West local partners). The buoy is a Datawell Directional WaveRider Mk III²⁴ and was deployed in 2009. It measures wave heave and direction, and water temperature (Datawell). These parameters allow the calculation of the wave period. The Channel Coastal Observatory's website²⁵ for the buoy also shows weather data provided by the Met Office and wave spectra data provided by Fugro GB Limited.

Only data describing the heave of the wave (i.e. the vertical movement of the buoy (in cm) or sea elevation), are used in the piece. The values can be positive or negative as the zero crossing corresponds to a static sea. The horizontal movements – movement towards North and West – are not used as they do not provide information on the sea elevation.

²⁴ <http://www.datawell.nl/Products/Buoys/DirectionalWaveriderMkIII.aspx>

²⁵ http://www.channelcoast.org/data_management/real_time_data/charts/?chart=98

The probable maximum wave height is calculated in order to determine the state of the sea by searching the minimum and maximum values in the data collected and subtract the minimum value from the maximum one.

$$H_m = H_{max} - H_{min}$$

where H_m is the maximum wave height, H_{max} is the largest positive value measured and H_{min} is the largest negative value measured. We call H_m the *probable* maximum wave height because H_{max} and H_{min} do not always correspond to the same wave (i.e. they are not necessarily the crest and trough of the same wave). The resulting value is therefore a probable wave height which gives an indication of the probable value of the maximum wave height. For the purpose of this project, H_m provides sufficient information for the intended transmission of meaning. During the piece's performance, this calculation can be repeated to search for a new and larger maximum probable wave height, as the number of data points received increases.

The buoy samples data at a frequency of 3.84 Hz which is then interpolated at a frequency of 1.28 Hz. The live data can be retrieved at a frequency of 1.28 Hz from in a JSON format from a URL specifically created for the performance²⁶. Alternatively, retrospective datasets corresponding to 30 minutes of data collection can be downloaded; they contain 2304 values at 1.28 Hz. We chose to use the interpolated data at a frequency of 1.28 Hz, which corresponds to a tempo of about $\downarrow = 77$ if each incoming value plays a beat. The frequency of 3.84 Hz would have created a tempo of $\downarrow = 230$, which was considered too fast for the intended piece. Although this was not implemented, there is the possibility of

²⁶ http://www.channelcoast.org/data_management/real_time_data/looe_nuria/

switching between transmission frequencies depending on the probable maximum wave height.

It is possible to create the illusion of real-time data coming in by using a downloaded dataset corresponding to 30 minutes of collection. In Max 7, the dataset is loaded and its values are printed sequentially at a rate of 1.28 Hz; they are then indexed as a list for further calculation. The possibility of using an offline dataset means that the piece can be performed even when continuous internet access is not available (the live webcam stream would not be shown in this case).

5.3 Mappings

The heave data are used to determine a large number of mappings which directly impact on the music heard. The piece is designed as a *modular* environment: individual modules are driven by data but the timing of events for each module can be controlled during the performance. The performer can turn a module on and off, control their volume, and sometimes apply sound transformations; each module is controlled independently. A USB-connected controller – a Korg Nanokontrol 2²⁷ - is used to trigger and control these parameters, but any other controller can be used. Figure 5.2 describes the functions assigned to the buttons, knobs and sliders on the interface.

We will now describe individual modules.

²⁷ <http://www.korg.com/uk/products/computergear/nanokontrol2/>

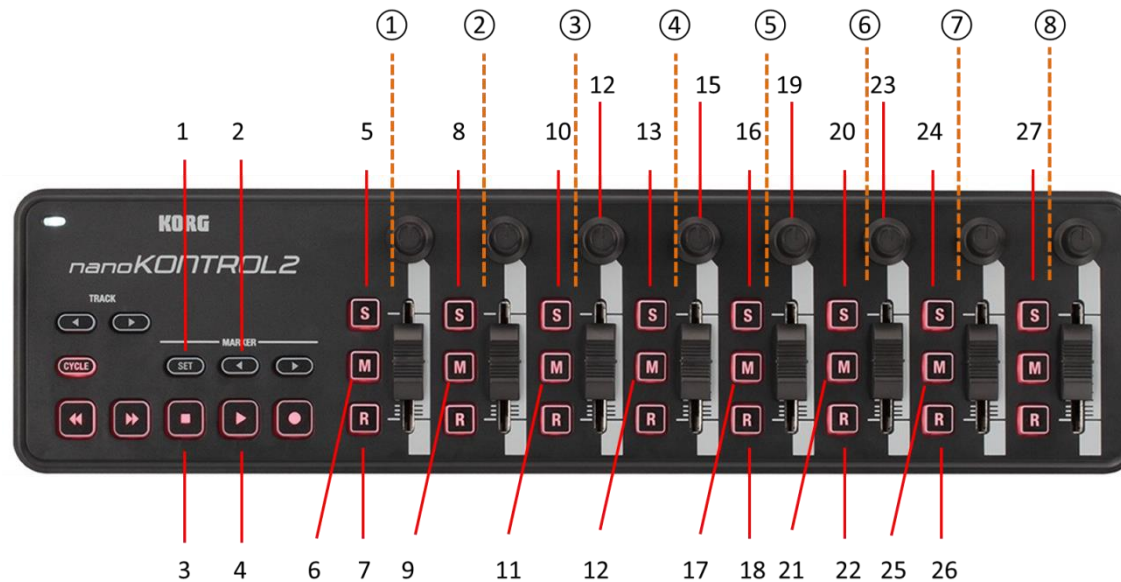

Fig. 5.2: Korg Nanokontrol 2 and its assigned functions.

1. Load dataset if not using real-time data stream. 2. Reload webcam stream. 3. Turn on sound (*ezdac~*). 4. Delete loaded dataset. 5. Start the beeps. 6. Calculate probable maximum waveheight 7. Stop the beeps. 8. Start the ocean sounds. 9. Stop the ocean sounds. 10. Start the pebble sounds. 11. Stop the pebble sounds. 12. Pitch shift the pebble sounds. 13. Start the bass sound. 14. Stop the bass sound. 15. Control the gain of the noise signal for the bass sound. 16. Start the boats and seagulls sound #1. 17. Stop the boats and seagulls sound #1. 18. Randomise the *phasor~* object for the boats and seagulls sound #1. 19. Control the gain of the saw signal #1 for the bass sound. 20. Start the boats and seagulls sound #2. 21. Stop the boats and seagulls sound #2. 22. Randomise the *phasor~* object for the boats and seagulls sound #2. 23. Control the gain of the saw signal #2 for the bass sound. 24. Start the ocean sounds with *2d.wave~*. 25. Stop the ocean sounds with *2d.wave~*. 26. Randomise the *phasor~* object for the ocean sounds with *2d.wave~*. 27. Calculate probable maximum waveheight value.

Sliders for gain control: ① Beeps ② Ocean sounds ③ Pebble sounds ④ Bass sound ⑤ Boats and seagull sounds #1 ⑥ Boats and seagull sounds #2 ⑦ Ocean sounds with *2d.wave~* ⑧ Master volume control

5.3.1 Synthesised Sounds: Beeps

The first module produces beeps which sonify the heave data through FM synthesis. The beeps are 781.25 ms long; 2304 consecutive beeps of this duration equal 30 minutes of duration.

The heave data usually range from 250 to -250 cm which would be equivalent to a five-metre wave. Considering that 4.25 m is the storm alarm threshold, this range was considered sufficient. The values between -200 and 200 cm are scaled to between 45 and 700 Hz; this is the sounding frequency of synthesised beeps. More specifically, this is the carrier frequency in Hz for FM synthesis. No modulation frequency is yet applied to the carrier frequency, so a simple sine wave is heard; this module is intended to be heard at the beginning of the piece. This simple data to sound mapping in a comfortable human hearing range provides a clear correlation between the incoming data and the sonification; the listener can easily understand the data representation.

The calculation of the probable maximum wave height determines the frequency in Hz of the modulation frequency, as well as its modulation index. Four possible elevation ranges were determined for H_m , each of which is mapped to a different specific modulation frequency and modulation index over the time domain of the note. Furthermore, these ranges determine the ADSR (Attack-Decay-Sustain-Release) envelope of the note. The four ranges are 0-100 cm, 101-200 cm, 201-300 cm and 301-600 cm. In turn, they trigger a modulation frequency of 0 Hz, 0.03 Hz, 0.6 Hz and 1 Hz, and modulation index and volume envelopes (Fig. 5.3). These were chosen to sound increasingly agitated or 'stormy', to reflect the information transmitted in the data. Specific values were purposefully chosen

because of the non-linear nature of FM synthesis, so a linear mapping of the data would result in unpredictable sound transformations.

In the stereo performance, the beeps are played at equal volume on left and right channels before the modulation begins. After the calculation of the wave height and the introduction of a modulation frequency, the stereo panning is determined by the wave height. For waves between 0 and 100 cm of height, the panning wanders from left to right in 4500 ms, every 6000 ms. This results in a gentle change between left and right. Between 101 and 200 cm of height, the panning change happens in 3500 ms, every 4000 ms. It is therefore a slightly quicker change in there stereo panning. Between 201 and 300 cm, the panning trajectory happens in 780 ms and is triggered every 781.25 ms. Consequently, each beep is panned from left to right or vice-versa in its entirety. Finally, between 301 and 600 cm, each beep is panned either completely left or completely right. There is no transition between them so that the panning is abrupt. The panning creates the impression of calmness or agitation, depending on the incoming data.

For the octophonic performance, the beeps play on the front two (left and right) speakers (Fig. 5.6). This means that throughout the performance, this literal mapping of the data is rooted in the front of the surround image, as a point of reference for the listener.

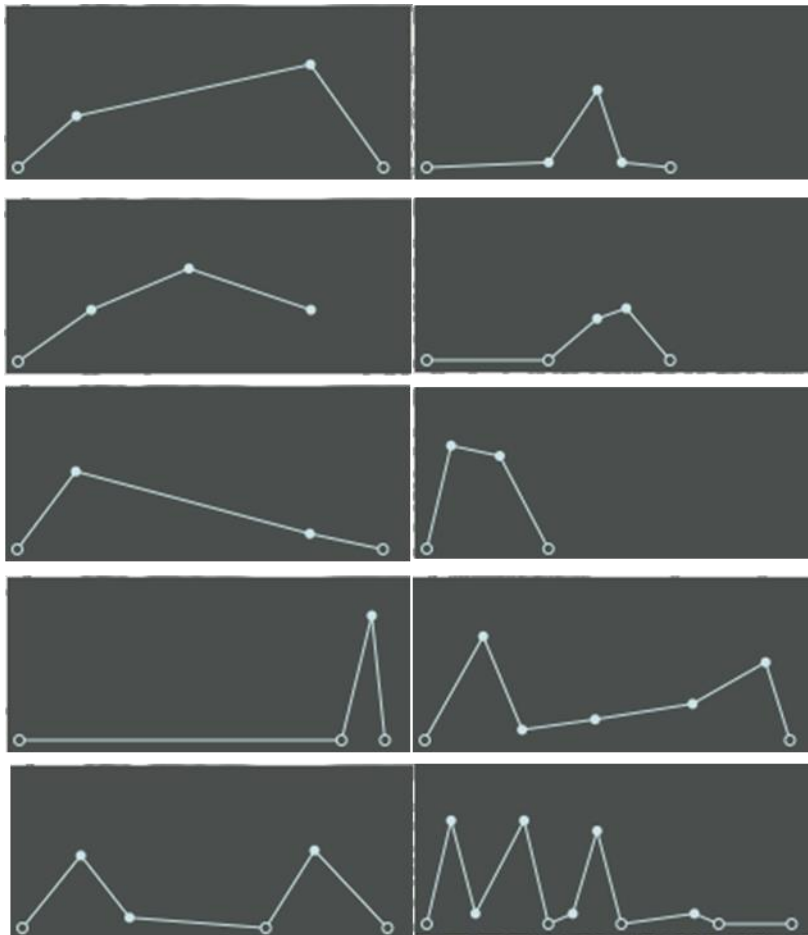

Fig. 5.3: The left column shows the modulation index envelopes; the horizontal axis denotes time domain of 781.25 ms and the vertical axis denotes the modulation index for values from 0 to 24. The right column shows the amplitude envelope for each note; the horizontal axis denotes the time domain of 781.25 ms and the vertical axis denotes the amplitude for values between 0 and 24. The first row shows the envelopes for the initial notes, the second row to fifth rows are for wave heights between 0 and 100 cm, 101 and 200 cm, 201 and 300 cm, and 301 and 600 cm, respectively.

5.3.2 Recorded Sounds: Ocean Sounds

The second module uses the buoy data to play and transform recorded sound. The sound recording is that of an ocean drum played by the percussionist Tim Williams; the instrument is similar to a rainmaker except that the grains are played inside a drum. It is difficult to record crashing waves in an outdoor setting because of the windy conditions required, which cause noise in recordings. The ocean drum provides a satisfactory alternative for creating the illusion of an ocean environment.

The sound recording is 31 seconds long; once started, it loops unless stopped. The heave data ranges control the spatialisation of the sound file. As the value of H_m gets larger, the panning of the sound file becomes more 'agitated'. The lowest range uses a narrow range of values with a *drunk* object which results in light variations in the stereo panning. The highest range uses a *random* object over the full range of values. It results in abrupt changes in the stereo panning of the sound.

For the octophonic performance, the probable maximum waveheight range determines the mapping to loudspeakers of the stereo signal. For the first two ranges, between 0 and 200 cm, the sound is played on all eight speakers; the left and right signal are routed to the four left (1, 3, 5 and 7) and four right (2, 4, 6 and 8) speakers respectively. In the next range, between 201 and 300, the stereo signal is split to one of the four left speakers and one of the right speakers; this changes randomly every 500 ms. Finally, for the last range, between 301 and 600 cm, the signal is sent to only one of the eight speakers. This means that some of the stereo signal is lost, as the left and right speakers can only receive the left or right signal respectively. This mapping is intended to feel immersive when the sea is calm, and choppy when the sea is rough.

5.3.3 Recorded Sounds: Pebbles

The third module uses a recording of pebbles being hit against each other; this segment is just over a second long. The patch creates a texture with the recorded sound that could be described as granular because short extracts of the sound (or grains) are combined to create a new texture. There are eight possible permutations of how the sound file can be played; it can be played forwards or backwards at different speeds (Fig. 5.4). Each permutation can be activated by a

bang whose occurrence is determined by a *sel* object set to 0 or 0 and 1 which receives values from a *random* object (either set at 3 or 4); the latter receives bangs from a *metro* object every 125 ms. This means that the sound will sound at aleatory times as determined by a random object. To further randomise the texture, the *metro* objects are themselves activated by pre-determined incoming buoy data values. The range of value 0-400 cm has been subdivided into ranges of 15 cm (the original values from -200 to 200 having been scaled to 0 to 600). Each incoming value will produce a *bang* for one of the *metros*, thus turning them either on or off.

The mapping is not linear in mapping the waveheight but somewhat arbitrary in that it assigns mappings to unrelated ranges. The resulting texture therefore does not describe the state of the sea in an intelligible manner; the incoming data is used too arbitrarily to clearly transmit information. Furthermore, in the octophonic performance the left and right signals are simply routed to the four left and four right speakers respectively. This mapping does not change with or reflect the state of the sea.

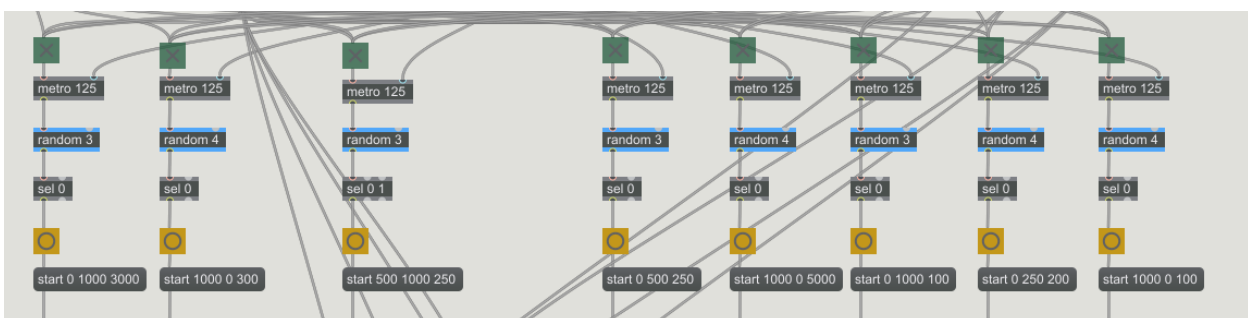

Fig. 5.4: Objects controlling the texture by using recordings of pebbles.

Finally, a pitch shift can be applied to the texture; this is done on the controller and is not determined by the data. The compositional intention is to create a ‘bass drop’ at this point of the performance. The bass drop is a musical gesture often used in Electronic Dance Music, it is the ‘moment in a dance track when tension

is released and the beat kicks in' (Yenigun, 2010). In spectromorphological terms, it is a high-energy gesture which introduces a new texture with bass beats. In this piece, the rising pitch shift introduces energy into the pebble texture before abruptly introducing a new bass-heavy texture (described in 5.3.4). Furthermore, the new texture sounds 'wobbly'; it borrows from the aesthetics of the *dubstep* genre (Clark, 2009) where the bassline 'wobbles' through the manipulation of low-frequency oscillators.

5.3.4 Synthesised Sounds: Bass Beat

The fourth module plays a 'wobbly' texture of repeating bass beats. They are created through the additive synthesis of a noise signal and two saw waves which pass through a resonant bandpass filter (*reson~*). The frequency of the saw waves changes every three data values; every third data value is mapped to the frequency of the saw waves. The values -200 to 200 cm are mapped to 100 Hz to 40 Hz. The length of each note is determined by the probable maximum waveheight; the larger the waveheight, the shorter the note and therefore the more agitated the bass line. Waveheights from 0 to 500 cm are mapped to 5000 to 2500 s.

As described above, the module can be turned on so that all other modules are muted. This creates a sudden change of texture, as well as a change in the background of the projected screen. Once turned on, the amplitude of the texture can be controlled independently of other modules.

For the octophonic performance, the stereo signal is routed to all the speakers to create an immersive environment.

5.3.5 Recorded Sounds: Boats and Seagulls

This module uses a recording of seagull screams and creaking boats captured at the harbour of Newton Ferrers. The sound file is sampled through the *2d.wave~* object, a two-dimensional wavetable which samples segments in a buffer. The length of the sample and the position in the wavetable are determined by the data. Larger values in the data (corresponding to a rougher sea) result in shorter samples, thus a choppy texture. The original sound sources remain recognisable, particularly the seagull sounds.

5.3.6 Two Recorded Sounds: *2d.wave~* and Ocean Sounds

The final two modules use the *2d.wave* object with different recordings: a different recording of seagulls screaming and the recording of the ocean drum (described in 5.3.2). For the octophonic performance, the first seagull texture is played on the front four speakers (1, 2, 3 and 4); the second seagull texture is played on the back four speakers (5, 6, 7 and 8). The ocean texture is played on all speakers.

5.4 Performance

There is no performance score for *The Voice of the Sea*. This is partly due to the fact that it has only been performed by the composer so far. Its set-up and existing performances indicate a suggested succession of events in time. The piece should describe the state of the sea regardless of the sequence of events; the information in the data should be discernible regardless of the performance decisions.

The piece's three performances (5.1) followed a similar pattern. The modules are introduced to the performance sequentially, from left to right, as laid out on the controller (Fig. 5.2). The piece begins with the sine beeps which are then modified

through frequency modulation, before introducing the ocean and pebble sounds. The bass module interrupts these textures by muting them. While the bass texture continues, the boats and seagull sounds are introduced, and finally the second ocean sounds. The continuation is to be improvised by the composer who re-introduces the various sounds to create new combinations of textures. To sum up, the beeps always begin the piece, the bass texture marks a break in the piece and the modules are introduced sequentially.

The first and third performance took place in February 2017 and January 2018 respectively. These months are prone to stormy conditions and indeed featured probable maximum waveheight values above 2.5 m. Unfortunately (perhaps), both performances missed actual storm conditions, so the system has not performed with extreme values. It is however possible to download data from any day of the year and perform the piece with a range of weather conditions.

The patch allows a performer with no knowledge of Max 7 to perform the piece, as the modules, the data and the webcam can be loaded and controlled with the controller. The instructions used by the composer can be seen in Fig. 5.5; they consist of a diagram of the controller and its assigned functions. These can be used by another performer to interact with the modular environment.



Fig. 5.5: Performance instructions used by the composer, showing the controller and its assigned functions.

Another possible performance set-up is as an installation, i.e. as a continuous performance rather than a 'sit-down' concert. The modules could be programmed to load at pre-specified intervals, or the audience could have access to the controller and control the modules. Again, this would be acceptable in the original conception of the piece as its meaning lies in the individual sounds rather than their time-based organisation.

The performances of *The Voice of the Sea* have included a visual element. The projection has shown a live webcam stream²⁸ which shows the Looe bay from the shore. Although this is of course not the location the buoy, it nevertheless shows the meteorological conditions at any given time and contextualises the placement of the buoy. The projection also shows a visual representation of the incoming data, mapped on an x-y axis. This is to give a visual reference to the audience, which might aid the understanding of the sonification process. The quite literal mapping of the data to beeps in the first module is analogous to this

²⁸ http://www.camsecure.co.uk/looe_webcam.html

simple graph; again, providing a point of reference to the listener. Finally, the background of the projection changes colours at times. The probable maximum waveheight's ranges are attributed different colours (green, yellow, red or black) and the bass beat module is assigned the colour purple.

The visual elements are kept deliberately simple and fairly static in order to not distract from the sonification elements. They are intended to support the audience's experience, rather than become the focus of attention.

5.5 Musical Language

5.5.1 Soundscape Music

The Voice of the Sea's aesthetics can be described as soundscape music²⁹ (described in detail in 3.4.2); the term of live electronics refers to the sound production method rather than to its aesthetics. The aesthetical considerations are in fact similar to those of *Blyth-Eastbourne-Wembury* as they combine environmental sound recordings and some sound synthesis, in the context of soundscape composition and musification. Both are intended to transmit information and engage the listener with issues around marine and coastal environments.

However, *The Voice of the Sea* involves a higher degree of live performance because the performer makes event-based decisions. Crucially, the data determine much of the sound-based decisions in the piece so that each

²⁹ The term "soundscape composition" refers to a kind of electroacoustic work [in which... [e]nvironmental sound recordings form both the source material and also inform the work at all its structural levels in that the original context and associations of the material play a significant role and reception.

In other words, the soundscape composition is context embedded, and even though it may incorporate seemingly abstract material from time to time, the piece never loses sight of what it is "about." (Truax, 2000, p. 124; in: Landy, 2007, p. 106)

performance is considerably different. For fixed media pieces, the performance element is often restricted to the diffusion of spatialised sound. A popular approach is to use a loudspeaker 'orchestra' (Malham, 1998, p. 171), which can distribute the sound in space; *MANTIS*³⁰ and *Beast*³¹ are examples of UK-based setups. *Blyth-Eastbourne-Wembury* can be understood as such: it is composed in stereo but has been diffused on the MANTIS system.

5.5.2 Spatialisation

Smalley claims that '[a]coustic music is the only sonic medium that concentrates on space and spatial experience as aesthetically central' (Smalley, 2007, p. 35). Space has been discussed already in previous chapters as 'unique' sound parameter rather than a 'byproduct' of the music (Lotis, 2003, p. 257). In *Blyth-Eastbourne-Wembury*, the soundscape progresses from a natural source-bonded space to an agential space. We have seen that this progression carries an important meaning in the piece, as it alludes to climate change and its effect on the coastal environment. In *The Sonification of Dark Matter*, the space is articulated mainly through the trajectory of sounds, this 'choreography of sounds' (Baalman, 2010, p. 209) is used to create temporality in otherwise non-temporal data. Spatial trajectories are a sound parameter to which data parameters are mapped.

³⁰ <http://mantisfestival.com/>

³¹ <http://www.beast.bham.ac.uk/>

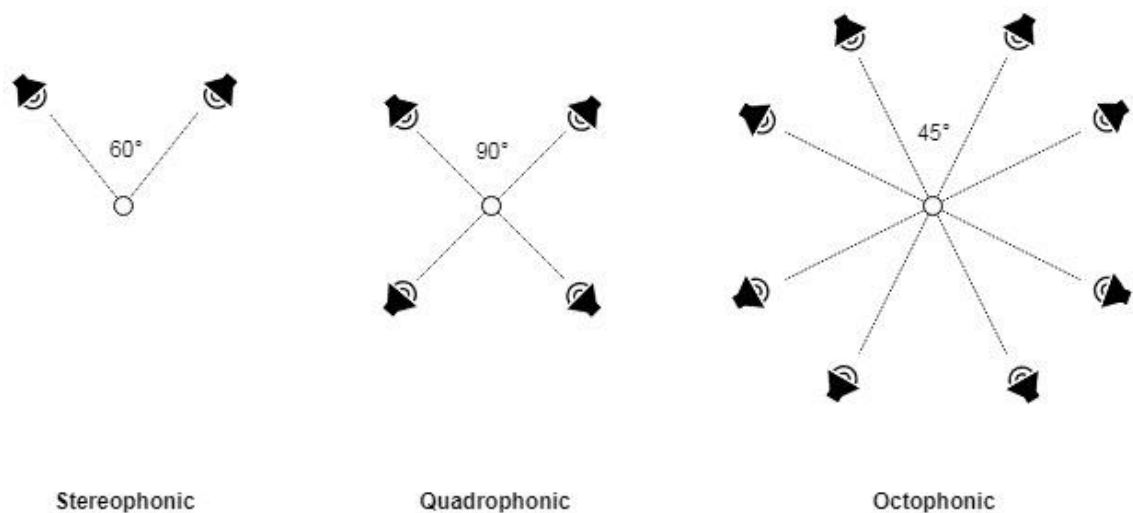

Fig. 5.6: From left to right, stereophonic, quadrophonic and octophonic speaker distributions.

In *The Voice of the Sea*, the spatialisation is intended to create an immersive space for the listener. The soundscape is meant to envelop them in order to create the illusion of an augmented marine soundscape. This idea will be further discussed in 5.6.1. The first performance of the piece used a quadrophonic speaker set-up with a stereo output. The left channel and right channels were played by the front and back left speakers (1 and 3) and front and back right speakers (2 and 4), respectively. This set-up allowed for a good number of listeners to stand within the space delimited by the speakers. However, only a few would have been able to stand in the ‘sweet spot, where the stereo image was best balanced. In fact, the reliance on a sweet spot and the sonic ‘holes’ in a quadrophonic set-up are one of its disadvantages (Baalman, 2010, p. 211). A more interesting performance space was afforded by the 8-speaker set-up in Huddersfield (*HISS* system). Octophony reduces the ‘holes’ in the image and allowed more listeners in the space, but still relies on the ‘sweet spot’ (Baalman, 2010, p. 211). It must be noted that no further diffusion was applied on the mixing desk as all the spatial decisions are made in the Max patch.

5.6 Emotional Content

5.6.1 (Re-)creating a Soundscape

The Voice of the Sea re-creates a number of marine soundscapes through the combination of the different modules. The soundscapes are constructed from separate recordings of different real soundscapes, to create a new and augmented soundscape. Stefani and Lauke describe 'exploded' soundscapes as follows (Stefani and Lauke, 2010, p. 257):

A soundscape may be spatially decomposed, or (re)composed in a similar way to an additive synthetic spectrum. The possibility of spatially 'exploding' or re-synthesising a soundscape from individual sonic components emerges if the soundscape has been recorded in a multichannel format. (Stefani and Lauke, 2010, p. 257)

In this context, the elements of the recomposed soundscape stem from different soundscapes rather than just one recorded in a multichannel format. Nevertheless, the idea of creating an augmented reality (AR) is still valid: an additive soundscape creates the illusion of marine soundscape which does not exist as such, in which the buoy sending data is contextualised. We refer to an AR rather than a virtual reality (VR) because of the *possibility* of the AR. If we consider VR as being on the opposite end of the spectrum to the real world³² (Milgram et al., 1994, p. 283), AR functions as an immersive environment which still obeys to some real-world laws. Although they have most often been used to create sonic VR, rather than AR, loudspeakers and headphones are an ideal medium to create such environments, (Prior, 2016, p. 5).

³² 'The commonly held view of a VR environment is one in which the participant-observer is totally immersed in a completely synthetic world, which may or may not mimic the properties of a real-world environment, either existing or fictional, but which may also exceed the bounds of physical reality by creating a world in which the physical laws governing gravity, time and material properties no longer hold. In contrast, a strictly real-world environment clearly must be constrained by the laws of physics.' (Milgram et al., 1994, p. 283)

During the performance, the listener experiences several augmented realities. First, they need to take a leap of faith in believing that the data are transmitted in real time from a buoy, particularly as the 'liveness' of the data is simulated during offline performances. Then, they are engulfed in a recreated soundscape intended to contextualise the buoy data and transport them to the imagined soundscape of the buoy location. Finally, they see a webcam stream from a coastal location in Looe, which again demands that they believe that it does indeed look out onto the buoy. Barrett defines such a 'spatial illusion' as where 'the perceived space appears real, but we are listening to an illusion in stereo or multichannel space produced through the phantom images from two or more loudspeakers' (Barrett, 2002, p. 314).

It is interesting to compare the simulated liveness to two examples of music produced with or by waves. First, the wave organ is an instrument which sounds as waves pass through it, as found in Zadar (Croatia) for example (Bašić, 2005). Here, the waves' physical interaction with a concrete structure produces a pitched sound. The listener experiences the liveness of both the waves and the sound production. The second example is Kirke's *Sound-Wave* project during which he controlled a wave tank and sonified the motion tracking data of a buoy in the tank (Kirke et al., 2015). In this case the audience experiences the liveness of the wave production but must buy into the augmented reality of the data sonification and sound production. *The Voice of the Sea* demands that listener experiences simulated liveness in their experience of the waves and the sound production.

5.6.2 Empathetic Sonification

Empathetic sonification is a sonification with a high degree of indexicality, where the relation between data and sound is intuitive (as described in 3.5.1). However,

the data should also be easily understood, so that the mapping is revealed to the listener without the need for much additional information. We argue that a clear understanding of the data from the sonification should demonstrate a clear relation between sound and data.

In the piece discussed here, the sound material is clearly related to the data source as most of it is source-bonded to marine environments. Some of the mappings are easily understood, such as the mapping of the heave data values to the frequency of a sine wave. But many other mappings are less obvious to the listener, particularly when dealing with random operations or wavetables. This is not necessarily an issue because other mappings still transmit the information to the listener. The reason behind the use of less obvious mappings was that they should transmit higher-level information; i.e., the sound should reveal information on the state of the sea through the music. This relies on a shared understanding of what constitutes 'choppier' or 'rougher' music as it represents a rougher sea (as understood from larger maximum and minimum values in the data).

Elements in the musification intended to describe a rougher sea include abrupt panning, more 'extreme' sounding timbres through FM synthesis and projected colour backgrounds which reflect the meaning of the data (with red and black as symbols of a rough sea and a storm respectively). While these elements create some variation in the piece depending on the incoming data, more options could have been considered to create even stronger differences between different higher-level meanings of the data. Some of the modules sound similar with all datasets, particularly when dealing with chance operations (pebble sounds). More extreme sound transformations and changes in amplitude could be considered as a way of transmitting information more clearly.

5.6.3 Climate Change

The Voice of the Sea is 'about' climate change even if perhaps less overtly than the previous piece *Blyth-Eastbourne-Wembury*. The latter uses data that directly relates to climate change since they show discrepancies between the average sea temperatures over a number of decades. The sonification was designed as to clearly transmit the difference between two datasets, and thus sonically display an effect of climate change. In *The Voice of the Sea*, the data describe the sea elevation; the higher-level meaning describes the state of the sea. However, it has been shown that winter wave heights have been increasing, resulting in extreme storms such of those of the winter 2013/14 (Castelle et al., 2018). Whether the increase of higher-energy waves is due to climate change or not, this trend is still worrying due to its impact on coastal areas, for example through dune and cliff erosion (Williams, 2018). Therefore, the heave data can still be regarded as related to climate change even if it is not usually understood as such. Furthermore, the piece encourages listeners to engage with a soundscape and thus a certain environment. The embodied experience of an augmented soundscape as well as the experience of the live data stream connects them with the buoy's surroundings. It is hoped that this immersion encourages listeners to reflect on issues concerning the sea, including climate change.

5.6.4 A Tradition

The musical representation of natural and human (or agential) soundscapes has a long-standing tradition, not least in Western Classical music. Natural phenomena such as birdsong and water sounds can be found in pieces from all eras. The 13th century rota *Summer is icumen in* already features a cuckoo; the lyrics 'sing cuckoo!' are sung on a minor third. In Clément Janequin's *Chant des*

Oiseaux (1529), the singers imitate the cuckoo (on a major third this time), a nightingale and a blackbird amongst others. In his *Pastoral Symphony* (No. 6), Beethoven writes birdsong and specifies the type of bird in the score, thus clearly acknowledging the practice even in a medium that does not allow for explanatory lyrics. Birdsong has continued to inspire composers well into the 20th and 21st century. Messiaen transcribed bird vocalisations methodically and wrote numerous pieces around them, such as *Catalogue d'oiseaux* (1956-58). His interpretation of birdsong was however expressed in the musical language of his time, atonally and with complex rhythms. The advent of recording technology also changed the way that composers might incorporate animal sounds into their work. Rautavaara's *Cantus Arcticus* (1972) uses the recording of swans and shore larks in the tape part, creating an atmospheric sonic background to the symphonic orchestra. In my own piece *Queen Canute* (2018), recordings of Herring Gulls are combined in a tape part that duets with the clarinet part.

This short overview of the use of birdsong (as an example of an enduring trope) in Western Classical music since the 13th century demonstrates the enduring appeal of animal sounds for composers, but also the evolution of musical styles and thus the range of ways in which they have been incorporated in music. The invention of recording technology has further influenced the tradition, showing composers' responsiveness to their environment but also technological advances.

Furthermore, evolving mechanical soundscapes have influenced music. Schafer argues that 'the growth in intensity of Western music is paralleled by a growth in frequency range'. Contemporary music has reached the limits of 'human audibility', not the least through 'electronic music and hi-fi reproduction equipment (Schafer, 1977, p. 115; Fig. 5.7). The growth of the musical dimensions can be

linked to the growth of the dimensions of the soundscapes in which humans live. Schafer proposes the emergence of the Alberti bass as an example of a technological advance which can be found in the music of the time. He particularly links its invention to the appearance of horse carts during the 18th century (Schafer, 1977, p. 112). Numerous further examples can be given, from Honegger's depiction of a steam train engine in his *Pacific 231* to the industrial rock of Rammstein.

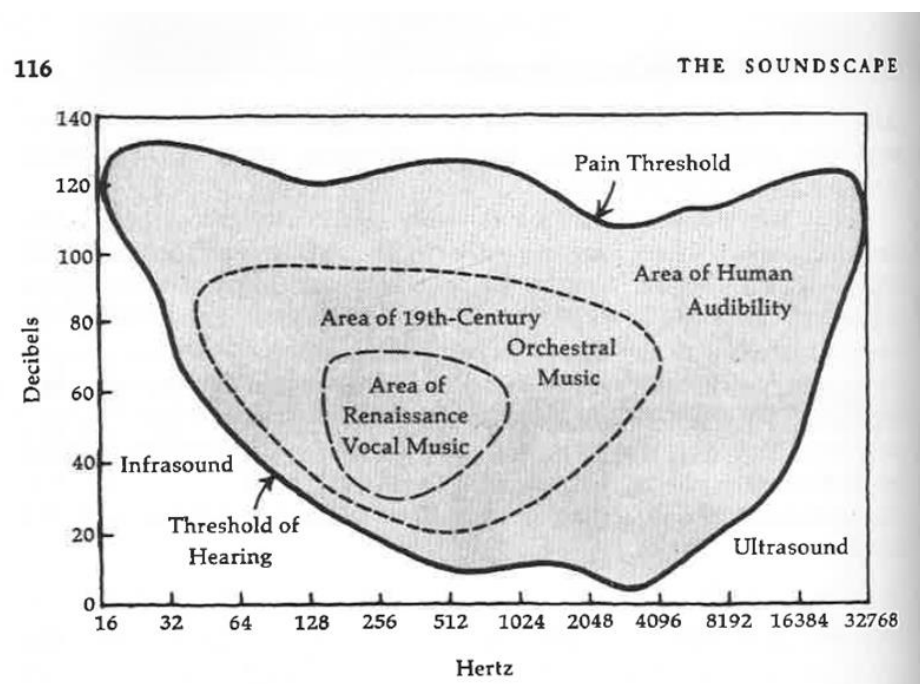

Fig. 5.7: Frequency and intensity of music from renaissance vocal music to 19th-Century Orchestral Music, within the range of human audibility (Schafer, 1977, p. 116).

The futurist movement argues that the 'revolution of music is paralleled by the increasing proliferation of machinery' (Russolo, 1913, p. 5). In fact, Russolo claims in 1913 that the 'evolution towards noise-music', music which incorporates noises of the mechanical soundscape, is inevitable because our ears become used to new sounds and 'keep asking for bigger acoustic sensations' (Russolo, 1913, p. 6). Although not aligned with the futurist movement, composers such as Edgar Varèse and George Antheil incorporated mechanical sounds into their

pieces around the same time; Antheil's *Ballet Mécanique* is particularly noteworthy in this respect.

The influence of evolving technology on mechanical soundspaces, and thus composers' inspirations, becomes particularly interesting when considering the advent of music and recording technology. The technology is not only imitated anymore, but actively used in the music. The Second World War precipitated a true revolution in music. Manning describes the post-war arts revival (2013, p. 19):

The revival of the arts after the Second World War took place in an environment altogether more favorable for the development of electronic music. The rapid advances in technology as a result of the war, an upsurge of interest from many quarters in new sound techniques, and a generally expansionist economic climate provided sufficient incentives for institutions to provide support.

The situation after the Second World War was favourable to composers or engineers wishing to create music with new technologies. The canon points at Pierre Schaffer in Paris and the WDR studio in Cologne as pioneers of electroacoustic music, although similar developments took place in other countries too³³. As we can see, composers have always followed developments in their agential and mechanical soundscapes closely and incorporated them in their music.

What then is the expression of this tradition for the contemporary composer? We argue that musification might serve this function as it simultaneously allows for the musical representation of the natural soundscape and the inclusion of new technology for creative purposes. Sonification itself is an evolving scientific method but also offers the possibility of incorporating other scientific fields into

³³ See for example Ricardo Dal Farra's *Latin American Electroacoustic Music Collection* at the Fondation Langlois (Dal Farra, 2010). It features Juan Amnábar's piece *Los Peces* (1957) which he began writing in 1953. For an interpretation of the collection, see Bonet, 2014.

musical composition. Furthermore, musification is a cutting-edge field which is only beginning to be seriously examined. The lack of evaluation methods for musification proves that it is still at an infancy stage; the evaluation framework proposed in Chapter 7 is therefore truly innovative. To sum up, the use of sonification as a compositional tool offers the possibility to use a developing technology to describe natural, agential and mechanical soundscapes, thus representing a significant development in music. In turn, this drive for innovation can be put in the context of a tradition of composers who have sought to do so through history.

5.6.5 Sound Buoys

Some buoys emit sounds to transmit information on their position or danger in the area when they cannot be seen, i.e. in foggy conditions. There are bell, gong and whistle buoys, which describes the sound production method that they use. Because they rely on wave movement to ring the bell or push water through the whistle, some are fitted with 'electronically operated horn[s]' (Maloney, 2008, p. 77). Runnel Stone buoy off Gwennap Head in Cornwall, for example, has a whistle fitted and previously had a bell which could be heard from the coast. It has also been reported that buoys can be heard from Looe. In foggy conditions, these sounds create an eerie soundscape which can hold emotional value for those who experience it.

It could be argued that a buoy that sounds a bell when the waves cause it to oscillate, is audifying the movement of the sea surface, and therefore the weather conditions. The process used in *The Voice of the Sea* is a sonification rather than an audification because the data are mapped to sound. However, the sonification process permits the recreation of the audification in a different location. In this

case, the audification exists within the real world; by adding the higher-level process of sonification, we create an augmented reality of an existing phenomenon.

In conclusion, the piece recreates a real phenomenon and the emotional connotations attached to it. In fact, some audience members have spoken about reminiscing on the sound buoys of Cornwall after hearing *The Voice of the Sea*.

5.7 Collaboration

The previous chapter discussed the different types of working relationships which might exist within an inter-disciplinary environment. We concluded that most working relationships which are termed as collaborations are in fact another type of relationship, as a true collaboration demands that all participants have equal decision-making power in a non-hierarchical structure (Taylor, 2016, p. 570). We also described the relation with the dark matter scientists as a *hierarchical* working relationship because they contributed only to some aspects of the process and did not take any decisions. For *The Voice of the Sea*, the intention was to create a working relationship which would involve scientists in more aspects of the process and allow them the possibility of making decisions.

Emerald Siggery of the Plymouth Coastal Observatory acted as the initial contact to provide information and access to the buoy data. The sonification process was explained to her in the hope that she might contribute some ideas on possible mappings or musical structure. Unfortunately, some resistance was encountered again, as she did not feel that it was her role to provide such ideas. Similarly, other participants enthusiastically provided their expertise without taking up the invitation to further participate. We can conclude that this was a hierarchical

working relationship, again; although this project was far more successful regarding interaction with scientists than the *Sonification of Dark Matter*. This is probably because I received full access to a technology that I knew how to use. I could use the data and technology as I wished, rather than rely on external help.

At this point, it might be interesting to mention that a true *collaborative* working relationship probably needs appropriate financial support. For specialists to work on a project outside of their area, some enticement must be offered. Otherwise, they might be reticent to invest time and effort in an interdisciplinary project. This underlines the difficulty of creating a true collaboration in the context of sonification and reinforces the idea that a composer of musification needs to aim to become a scientist-composer.

5.8 Conclusions

We have discussed the composition process of *Voice of the Sea*. The data source, the data handling and the data to sound mapping have been described. Furthermore, the probable maximum wave height has been defined as the probable height of the highest wave in the dataset, as the data does not give information on which wave each value corresponds to.

The piece consists of a modular environment, where each module can be controlled individually as it uses a different sound source which is transformed by the incoming data. There is no fixed score for the performance although the set-up of the modular environment suggests a chronology of events. We have also described the visual element of the performance, which is meant to support the listener in their understanding of the data and the piece.

The mappings are intended to provide higher-level information from the data; the mappings should be designed so that the state of the sea should be discernible from the resulting musification. While listeners' emotional reaction to any piece is unique and cannot necessarily be predicted, there should nevertheless be an audible difference between different sea conditions; hopefully the emotional connotations for each intuitively correspond to the state of the sea. Further improvements have been proposed in this regard.

The piece has been contextualised as soundscape music through its use of spatialisation. The augmented reality created by sonic and visual decisions is shown to support the musification's higher-level meaning around marine environments around the effect of climate change on them.

The shared working relationships established during the composition of *The Voice of the Sea* have been discussed, referring to the discussion on collaboration in 4.7. Although a true collaboration was not achieved, we have found that the working relationships in this project were far more successful than in the previous one.

Finally, the use of sonification as a compositional tool is contextualised within a tradition of incorporating natural, agential and mechanical soundscapes within musical works. At the same time, it is proposed as an innovative compositional method which responds to composers' wish to use new technologies in their process. This discussion adds to the possible reasoning for using sonification in music.

Chapter 6

Wasgiischwashäsch: Musical Borrowing in Musification

'I like beautiful melodies telling me terrible things.'
- Tom Waits

'Je ne dis les autres, sinon pour d'autant plus me dire.'
'I quote others only in order to better express myself.'
- Michel de Montaigne

This chapter discusses the piece *Wasgiischwashäsch*, for chamber ensemble, which uses data related to climate change in Switzerland. It proposes the use of musical borrowing as a tool in the sonification process to improve the information process.

The piece can be found on the accompanying CD (see Appendix 2) as *Wasgiischwashäsch*.

6.1 Overview

Wasgiischwashäsch was commissioned by *Peninsula Arts*, to be premiered by the *Peninsula Arts Sinfonietta* at the Peninsula Arts Contemporary Music Festival Gala Concert on 25 February 2017. It is a piece for chamber ensemble which sonifies climate change in Switzerland through re-mapping of musical parameters of Rossini's *William Tell Overture* (mov. 3 and 4). The datasets used for sonification describe the average temperature of the country since 1864, and the differences between the average temperature in Switzerland and the world.

The title *Wasgiischwashäsch* was chosen because it is a uniquely Swiss word (which sounds particularly musical to the composer), even though its meaning bears no direct relationship to the piece; it means 'very quick' in Swiss German.

The full score can be found in Appendix 1.

6.1.1 Compositional Process

This orchestral piece combines the existing structures of Rossini's *William Tell Overture* as well as two datasets of meteorological data. While the structure of the piece is rigid, some artistic liberties were taken to produce mappings which underline the message of the piece. As temperature deviations become larger, the mappings distort the original score further; the distortion of music signals a change in the data, thus climate change.

6.2 Data

The data used – temperature temporal trend – give a measure of the extent of climate change in Switzerland. Data were extracted from the 2015 report on national climate published by MeteoSchweiz³⁴. Data are shown in two graphs. The first graph (Fig. 6.1) shows the average annual temperature in Switzerland from 1870 to 2010 as a continuous black line. Negative and positive differences from the average temperature between 1961 and 1990 appear as blue and red bars. The average temperature values were used for sonification. Values before 1920 remain below -0.5 C° despite fluctuations; after 1920 they never drop below this value again. The values rise by 0.5 C° between 1920 and 1980, with some

³⁴ <http://www.meteoschweiz.admin.ch/>

considerable positive differences in the late 1940's. After 1980, the values rise dramatically with the highest difference of about 1.25 C°, in 2010.

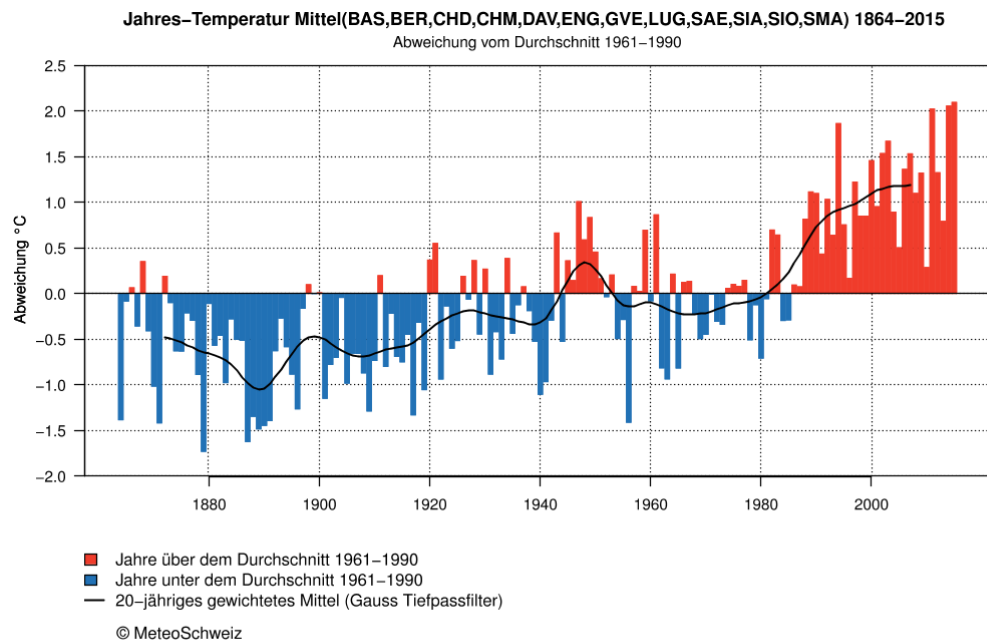

homogval.ev01.2.11.17 / 21.01.2016, 01:42

Fig. 6.1: Deviation of average yearly temperature in Switzerland, 0.0 on the y-axis is the overall average temperature value. Years above average appear in red and those below average in blue. The black line is the weighted average. (MeteoSchweiz, 2015a)

The second graph (Fig. 6.2) shows the temperature deviations from the overall temperature average (corresponding to the years between 1864 and 1900) from 1864 to 2015; comparing Switzerland (in red) with the global average (in black). It shows that temperature deviations are far more pronounced in Switzerland while their average value also rises by more than 2.5 C°. For 2015, the temperature deviation between Switzerland and the global average was of more than 1.5 C°.

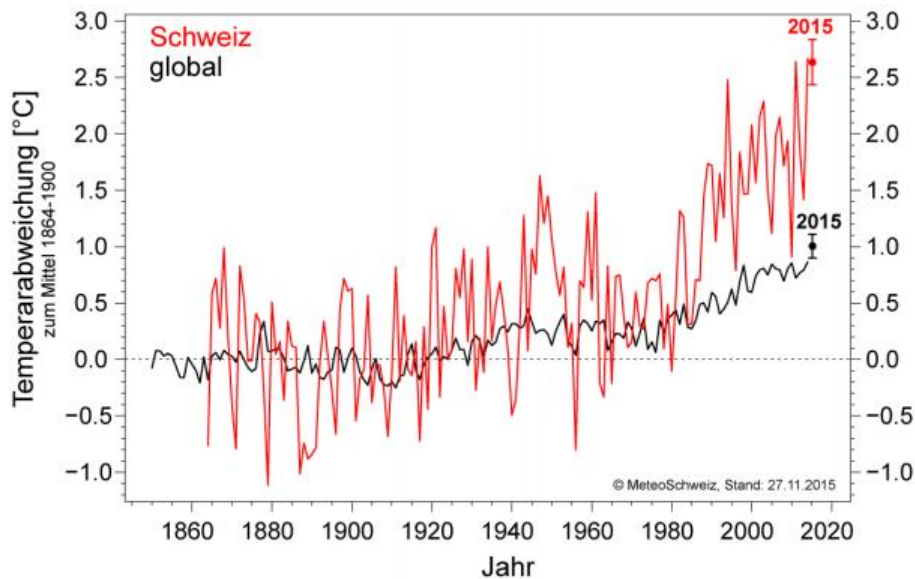

Fig. 6.2: In red, the temperature deviations from the average in Switzerland. In black, the global temperature deviations from the average. (MeteoSchweiz, 2015b)

Climate change in Switzerland is occurring at a more rapid pace than the world average (MeteoSchweiz, 2016); this is partly due to its alpine nature and it could have catastrophic consequences for its geography: melting glaciers, avalanches, floods, etc. (MeteoSchweiz, 2015a). This might have direct effects on the human population through an increasing number of natural catastrophes. Audification has previously been explored as a method for detection and prediction of river floods, because of the cognitive ability to differentiate between smaller changes aurally than visually (Sonifyer, 2009).

The data sets were extracted from the graphs with the online tool WebPlotDigitizer³⁵. This software allows the user to super-impose an x-axis and y-axis on the graph, calibrate them and manually extract the values corresponding to the data points. The resulting year and temperature data can then be used for sonification.

³⁵ <https://automeris.io/WebPlotDigitizer/>

6.3 Using the *William Tell Overture*

Data are sonified by mapping data parameters to musical parameters of an existing piece of music, Rossini's *William Tell Overture* (1829). The overture consists of four movements: *Dawn*, *Storm*, *Ranz des Vaches* and *March of the Swiss Soldiers*. The last two movements are used in *Wasgiischwashäsch*; they are very well-known examples of Western Classical music. A *Ranz des Vaches* denotes a Swiss melody played on a horn to call the cattle; the earliest mention dates from 1545. It has subsequently been used by a number of classical composers such as Rossini, Berlioz and Liszt (Baumann, 2010). It is considered by many to be the unofficial national anthem of Switzerland (cequelaino, 2008). Its underlying symbolism makes it an ideal musical source to transmit information about Switzerland. As described in 3.5.1, an empathetic sonification might use a sound source which establishes an intuitive emotional connection between data and sound. *The March of the Swiss Soldiers* is one of the most popular melodies in the world, often used in movies and adverts. As a result, Western audiences might recognise its melody even if they cannot name it; some might also associate it with other, subsequent, uses, such as in the movie *The Lone Ranger*. Nevertheless, its popularity aids the information transmission to lay audiences because of the existing shared knowledge between listener and sonification designer.

The *William Tell Overture* is scored for symphony orchestra: a piccolo, a flute, two oboes with cor anglais doubling, two clarinets in A, two bassoons, four French horns in G and E, two trumpets in E, three trombones, timpani, triangle, bass drum and cymbals, and strings. However, the *Peninsula Arts Sinfonietta* only had a limited number of musicians and instruments available: a clarinet, a bassoon,

a trumpet, a trombone, timpani, percussion, a violin, a viola, a violoncello and a contrabass (Table 6.1). This slightly unusual combination of instruments lacks high-pitched instruments which is problematic when re-scoring the overture. The *Ranz des Vaches* features solos in the flute and cor anglais parts, which are both missing from the new instrumentation. The lack of second violin also considerably increases the workload for the first violin and viola in the in the *March of the Swiss Soldiers*.

Tab. 6.1: The left column shows the original instrumentation of the *William Tell Overture*. The right column shows the instrumentation of *Wasgiischwashäsch*, italics denote an instrument that was not originally part of the Peninsula Arts Sinfonietta.

William Tell Overture - Rossini	Wasgiischwashäsch - Bonet
Flute and Piccolo	/
2 oboes (1 cor anglais doubling)	/
2 Clarinets in A	1 Clarinet in B \flat
/	Melodica
2 Bassoons	1 Bassoon
4 French Horns in G and E	/
2 Trumpets in E	1 Trumpet in B \flat
3 Trombones	1 Trombone
Timpani	Timpani
Bass Drum, Cymbals, Triangle	Bass Drum, Cymbals, Triangle
Strings	1 Violin, 1 Viola, 1 Violoncello, 1 Contrabass

In *Wasgiischwashäsch*, the clarinet plays the flute part during the *Ranz des Vaches*, which is at times demanding as the high-pitched runs better suit the flute. The melodica was added the ensemble to play the oboe and cor anglais parts in

this duet. Its limited range of 2 ½ octaves means that it could not have played the flute part (Table 6.1). The melodica is a cheap and portable free reed instrument with a keyboard, with a sound similar to that of an accordion. The model used for the premiere was a Hohner Airboard with 37 keys. While this instrument is mainly used in pop music and for classroom settings, its sound was deemed to be reminiscent of folk music and therefore evocative of the music of Swiss cattle herders. This is because free reed instruments are often played in folk music, for example the accordion, the melodeon or the concertina.

The parameter mapping has been applied to the score with the original orchestration, before reducing it to the available ensemble. The piece can therefore still be performed with the full ensemble or be re-orchestrated for another combination of instruments.

From here on, the third and fourth movements of the *William Tell Overture* will be referred to as first and second movements when talking about *Wasgiischwashäsch*.

6.4 Mappings

Figure 6.1 shows that before 1920 the values of the average annual temperature in Switzerland lay around or below the -0.5 C° mark. They rose above -0.5 C° after 1920, signalling the beginning of a continuous temperature rise (the slight decline in the 1950's should be disregarded as it follows a dramatic increase in the late 1940's). The second graph (Fig. 6.2) reveals a growing difference between the average temperature in Switzerland and the world, for the same time period. This difference is also used for parameter mapping, particularly tempo and registers.

The year to bar ratio was calculated so that the year 1920 would coincide with the end of the first movement. The *Ranz des Vaches* has 51 bars (at $\text{♩} = 76$) and the *March of the Swiss Soldiers* has 251 bars (at $\text{♩} = 152$); because the latter is scored at quadruple tempo, the equivalence at $\text{♩} = 76$ would be of 51 and 62.75 bars. In order to map the first and second movements to the years 1864 - 1920 and 1921 – 2015 respectively, the first movement is mapped as two bars per two years while the second movement is mapped as five bars per two years. The reason for not mapping a year per bar in the first movement is to not disturb the flow of the piece excessively with constant changes in mapping.

For the first graph, the value of -0.5 C° was chosen as the 'zero', where the musical parameters remain the same as the original. This is because 1920 is the year when the average annual temperature rose above this value and never returned below it; it marks the beginning of a warming climate. Any deviation from this value results in changes in the musical parameters of the concerned bars. The parameters affected are: pitch, intervals, harmony (modes, modulation, atonality) and rhythm. Rises in temperature result in rising pitches for high registers and lower pitches for low registers; this eventually results in extreme registers at higher temperatures.

A deviation of 0.2 C° corresponds to a deviation of a semitone. In the first movement where the temperature lies below the mean, this translates as flattened notes, diminished intervals and chromatic runs (Fig. 6.3). In the second movement, this usually results in sharpened notes and augmented intervals. Changes in rhythm can be seen in the *Ranz des Vaches*, where some runs are given more complex rhythms (for example bar 26); higher temperatures result in

more complex rhythms. The mapping for these rhythms is not entirely linear but rather based on compositional intuition.

For the second graph, the degrees of difference between the global and Swiss temperature deviations determine parameters such as tempo, dynamics and distance between registers. The *Ranz des Vaches* is at the original speed, as is the beginning of the *March of the Swiss Soldiers*. As the difference rises, the piece's tempo becomes slower. This first happens in bar 101 where $\downarrow = 120$, before returning to $\downarrow = 152$ in bar 137; this corresponds to the rise in temperature during the 1940's. The final tempo is $\downarrow = 40$ which completely alters the character of the piece (Fig. 6.4). The dynamics are mapped similarly, with a rise of temperature translating to quieter music. The end of the piece is *pp* with a *diminuendo al niente*. Again, the original is unrecognisable.

The *fff* at bar 283 is an 'incorrect' mapping but serves a dramatic function. The sudden change in dynamics does not correspond to the mapping of the data at that bar, but it underlines the slow tempo which is introduced by a long crescendo. While clear mapping rules were laid out before the composition of the piece, some artistic liberties have been taken to emphasise interesting features in the data and create a more interesting musical experience. Such adjustments are reasonable within the context of musification where the artistic quality of the work has importance, although one might argue that it does not satisfy the definition of a sonification which should be systematic and repeatable with different data (Hermann, 2008, p. 2). However, a certain freedom should be given mapping decisions where they might support the understanding of data - for example, by highlighting or introducing relevant passages – if some basic principles of

sonification are observed. Artistic liberties taken to support the functional or aesthetic aspects of a musification will be further discussed in Chapter 7, which proposes an evaluation framework to discuss this issue.

The image shows a musical score for the beginning of the third movement of the first movement of *Wasgiischwashäsch*. The score is in 3/8 time with a tempo of Andantino (♩=76). It features parts for Flute (Fl.), Cor Anglais (C. A.), B♭ Clarinet (B♭ Clarinet), and Melodica. The Flute and Cor Anglais parts are identical for the first five bars. The B♭ Clarinet part has diminished intervals in bars 6-8, and the Melodica part has a chromatic run in bar 13. The score includes markings for 'Solo', 'p dolce', and 'tr' (trills).

Fig. 6.3: Comparison of the beginning of the third movement of the first movement of *Wasgiischwashäsch*. Note that the cor anglais sounds a fifth below the written pitch, so the first five bars of both are identical. In continuation, the B♭ clarinet part has some diminished intervals (bars 6-8) and the melodica part has a chromatic run (bar 13).

6.5 Musical Language

6.5.1 Listening to Climate Change Data

Data values describing climate change, particularly in temperature datasets, have a general tendency to rise. Too often, temperature values are mapped to pitch and low temperatures are mapped to lower pitches, as seen in Quinn and Meeker's *Climate Symphony* (Quinn and Meeker, 2001) or Crawford's *A Song of our Warming Planet* (Ensia, 2015). As a result, the mappings of climate change

data are often similar and use a very limited number of musical parameters. Innovative sonification solutions are necessary to produce interesting works with similar data.

In the first piece of this project, *Blyth-Eastbourne-Wembury*, the difference between the overall and the rising temperature was sonified. The data used describe the higher-level meaning of the rising values, rather than the values themselves.

When approaching the *William Tell Overture* score, the first idea was to assign louder dynamics and faster tempi to rising temperature values. However, the *March of the Swiss Soldiers* already edges towards the limits of performance through its fast tempo, loud dynamics and a filled frequency spectrum. The mappings are therefore 'inversed': the higher the temperature rises, the slower and quieter the music becomes. The result is all the more disconcerting but also comical; this will be further discussed in 6.6.

6.5.2 Which Musical Language?

Wasgiischwashäsch begins in G major and does not modulate until after the first cadence (Fig. 6.3); the musical language is tonal. It then modulates throughout the first movement until it becomes increasingly dissonant in the second movement. It eventually becomes completely atonal and removed from the harmonic language of the *William Tell Overture*. The stormy ending becomes an almost atmospheric section of music 'dissolving' as the instruments play quiet held notes at the extremes of their registers, at the tempo $\text{♩} = 40$ (Fig. 6.4). As a result, the change in musical language – where the original style becomes

unrecognisable – signifies a change in the data. The data’s meaning is embedded in the musical structure.

The image shows a musical score for the ending passage of *Wasgiischwashäsich*, bars 298-303. The score is written for a full orchestra and includes the following parts: B♭ Clarinet (B♭ Cl.), Melodica (Mel.), Bassoon (Bsn.), Trumpet (Tpt.), Trombone (Tbn.), Timpani (Timp.), Cymbals (Cym.), Bass Drum (B. Dr.), Violin (Vln.), Viola (Vla.), Violoncello (Vc.), and Contrabass (Cb.). The music is in 4/4 time and features a variety of dynamics, including *pp* (pianissimo), *p* (piano), and *ppp* (pianississimo). The score includes a fermata over the final measure of the piece. The key signature is one sharp (F#) and the time signature is 4/4. The score is marked with a tempo of $\text{♩} = 40$.

Fig. 6.4: Ending passage of *Wasgiischwashäsich*, at tempo $\text{♩} = 40$ (bars 298-303).

6.5.3 Scientist-Composer

The compositional process described in this chapter demands musical skills such as knowledge of tonal harmony and orchestration. Conceivably, the piece could have been produced by transposing a score through music notation software or pitch-shifting a recording. The first option would have resulted in a piece with

extreme registers that are impossible to play with conventional instruments; it would also have resulted in simplistic mappings to a limited range of musical parameters. The second method would introduce artefacts that appear through pitch-shifting.

An example of pitch-shifting is a sonification of the value of the pound 'to the tune of' the British national anthem³⁶. The tuning of *God Save the Queen* rises or falls according to the value of the pound before and after Brexit (Belfast Telegraph, 2016). It uses pitch-shifting to achieve this effect, which is clearly audible. We would therefore consider it of average musical quality, as the modification of the original recording takes precedence over qualitative considerations. It is however an excellent example of an empathetic sonification. First, the relationship between the data and the sound is very clear because *God Save the Queen* is an obvious sonic symbol of the British economy. Furthermore, the mapping is easy to understand because of the public's knowledge of the British anthem; any pitch shift will be recognised, therefore any change in data. In conclusion, by distorting the national anthem in a comical but grotesque manner, a clear and emotionally engaging sonification is created.

However, in order to avoid issues that arise when modifying a recording, or creating scores which cannot be played, a more sophisticated approach is necessary. Considerations beyond the ability to simply map data to musical symbols are necessary, for example because the instruments' affordances must be taken into account. It could therefore be argued that a musification such as *Wasgiischwashäsch* can only be written by a composer, or a scientist-composer.

³⁶ <https://www.belfasttelegraph.co.uk/video-news/video-listen-to-the-struggle-of-the-pound-since-brex-35112287.html>

6.5.4 Orchestral Sonification

The piece is intended to be played by an instrumental ensemble, whether in the instrumentation described here or a similar instrumentation. It is rare to find sonifications which are intended for or played by an instrumental ensemble. This is understandable in functional applications where the use of instrumental performers would be impractical or impossible, such as in hospital settings. In other cases, the use of sound synthesis or MIDI is the most practical process as it can be performed on just one piece of hardware; as described for *The Voice of the Sea*, where the data handling and sound production happen with the same software.

The use of an instrumental ensemble adds a performance element to the sonification, therefore entering the realm of musification. Some examples of sonifications played acoustic instruments include John Eacott's *Flood Tide* (Eacott, 2012) and Daniel Crawford's *A Song of our Warming Planet* (Ensia, 2015). In both cases, the primary purpose of the sonification is artistic even though both composers express a secondary intention of informing the listener about the environment. Because of the inherent performative element of instrumental ensembles, such sonifications will most likely be of an artistic nature rather than just functional.

In this case, the orchestral performance of the sonification was both necessary and beneficial. Some of the compositional decisions must be traced back to the demands and possibilities afforded by the nature of the concert and the available instrumentation for *Wasgiischwashäsch*. As discussed earlier, a limited and specific instrumentation was available. Furthermore, the use of an orchestral ensemble can create an emotional connection with the listeners. Most audiences

are familiar with the symphony orchestra and its sound, which fosters a reassuring familiarity with the piece they are hearing. As the concept of musification might be novel to them, the presence of a symphony orchestra can give the listeners 'something to hold on to'. Landy defines the 'something to hold on to factor' in relation to 'sound-based works', such as electroacoustic music, as 'characteristics that could provide listeners with a listening strategy that would allow them to find a way into these works' (Landy, 2007, p. 26). Another aid for the audience is the programme note which describes the process and intention of the piece to support their understanding of the music. To conclude, an orchestral sonification can be beneficial in the information process because it creates familiarity and 'something to hold on to' for the listener.

6.6 Emotional Content

6.6.1 Musical Borrowing

The compositional practice described in this chapter is *musical borrowing*, which can be defined as the 'deliberate evocation within a composition of a different musical work' (Bicknell, 2001, p. 185). Often only a fragment of the borrowed piece is used in the new piece; in *Wasgiischwashäsich* the entirety of the work is used. This form of musical borrowing is called 'modeling', because it models 'a work or section on an existing piece, assuming its structure, incorporating part of its melodic material, imitating its form or procedures, or using it as a model in some other way [...]' (Burkholder, 1994, p. 854).

It is important to note that the practice of musical borrowing in this case does not constitute plagiarism because of the creative 'intention'; the audience does not hear the musical material as being originally mine (Bicknell, 2001, p. 185). That

is because of their 'musical literacy' (Bicknell, 2001, p. 187), as they know the piece and its origin already. Furthermore, the programme notes for *Wasgiischwashäsch* detail the compositional intention and process, which points the audience towards musical borrowing.

6.6.2 Remix

It is increasingly common to hear remixes of classical music, where digital technologies are used to create a re-interpretation of a classical work; this involves sampling parts of a piece (Barham, 2014, p. 129). However, the piece described here does not use samples of recordings of the *William Tell Overture*; the entire piece is re-scored and performed. The process does not alter the piece's structure in the way that sampling does (Barham, 2014, p. 141). Furthermore, remixes are often characterised by a dichotomy between the musical language of the sample and the resulting piece (Barham, 2014, p. 142). In *Wasgiischwashäsch*, the musical language modulates according to the affordances of the data but is not inserted into a work with an altogether different style. In fact, the change of musical language is produced by specific mappings which indicate a drastic change in the data. Therefore, the change in musical language is crucial in communicating the message of the data: an alarming rise in average temperature values.

Wasgiischwashäsch results from a compositional practice that cannot be labelled as remixing because of its process and artistic intention. While there is some substantial reworking of the musical material, the structure of the original piece is maintained. Its title does not directly relate to that of the *William Tell Overture* either, so that it is not perceived to be a remix (it is not called *The William Tell Overture remixed!*).

6.6.3 Arrangement

The term of arrangement could have been applied to the process as arrangements have historically included a large degree of compositional decisions. It does not only refer to 'the transference of a composition from one medium to another' but can also involve 'some degree of recomposition' which results in 'paraphrase which is more the work of the arranger than of the original composer' (Boyd, 2001). The practice of arranging is prevalent and well-documented in Western classical music. Examples of arrangements with substantial reworking can be found in Liszt's work, for example; from 'straightforward transcriptions [...] to elaborate paraphrases of enormous technical difficulty, such as those based on Mozart's *Don Giovanni*, Verdi's *Rigoletto* and several of Wagner's music dramas' (Boyd, 2001). It is also common for composers to arrange their own work to create new work, as found in Beethoven's work, for example (Abraham, 1982, p. 285). It must be noted that in the early stages of Western Classical music, instrumental idioms were less prevalent so that scores might be played on a variety of medium. As instrumental writing has become increasingly idiomatic, the complexity and importance of transcriptions has increased (Howard-Jones, 1935, pp. 305-306).

Wasgiischwashäscht is not a transcription of the *William Tell Overture* because of its compositional intention. While it is indeed a transcription to a different medium with some reworking, it is intended as a piece in its own right which serves a very different purpose to the original. Again, the use of Rossini's music is a means for information transmission and the title of the new piece is a clear statement of difference between the two. However, the arrangement of *Wasgiischwashäscht* is

possible and indeed encouraged to adapt to new performance contexts; to be played by ensembles with different instrumentations.

6.6.4 Musical Literacy

The listener can theoretically listen to a piece using musical borrowing without the knowledge of the borrowed piece, because the resulting piece is a self-contained musical work (Bicknell, 2001, p. 189). This is also the case in *Wasgiischwashäsch* (although unlikely to happen) because the musification is written as a self-contained piece of music; that is a piece that can be enjoyed without the need for additional information. However, the understanding of the layers in the piece adds complexity to the listener's experience. The transmission of information about the climate change data is one of these layers. But understanding of the sonification process also elucidates the reason for the use of the *William Tell Overture* and its transformation during the piece. In fact, it might be difficult for the listener to enjoy the piece without the understanding that it is a musification which borrows from the Western canon for a specific purpose. To sum up, it is almost certain that the listener knows the *William Tell Overture* and can grasp therefore some of the compositional intentions.

6.6.5 Humour

Let us shortly return to the practice of modifying the recording of a well-known musical piece to transmit data, as seen with the distortion of *God Save the Queen* according to the exchange rate of the Pound after Brexit (see 6.5.3). Another example uses the song *Ice Ice Baby* by Vanilla Ice as a musical source to which flood tide predictions in the US are mapped³⁷. The number of predicted flood tides

³⁷ <https://www.pri.org/stories/2015-08-14/how-many-floods-will-these-american-cities-have-2030-2045>

above the 'normal' level determines the tempo during the song (Keng, 2015). The result is a rather amusing sped-up version of the song for the years 2030 and 2045. The comicality stems from the distortion of the lyrics which become very fast and high pitched.

The '*Ice Ice Baby* sonification' can be understood in the context of the 'Replacement Remixes' online trend. This term is used to describe videos where certain elements are replaced by other (Know Your Meme, 2017). More specifically, some of the most popular videos of this kind involve changing the speed and pitch of the video every time a trigger appears. A popular example is a video which plays the *Bee Movie* in full but speeds up every time the word 'bee' appears. As expected, the trigger appears frequently so that the 91-minute long original is played in seven minutes (OMonsTaa, 2017). The rising popularity of these videos could be attributed to the comical effect generated by the extreme modification of familiar material, and the increasing access to commercial software which can produce them.

As discussed earlier, *Wasgiischwashäs* could have potentially been written by using time and pitch-shifting, which would have positioned quite clearly in the practice of Replacement Remixes. We have discussed the reasons for a more sophisticated, but less accessible approach to the musification process. Nevertheless, the piece also produced some hilarity with some laughter in the audience during the performance. This shows that although the approach is slightly different, the practice of distorting a musical piece can be perceived as 'funny' by listeners. Some listeners of *Wasgiischwashäs* reported laughing during the performance but feeling 'bittersweet', because they realised that the cause of the amusement was the alarming climate change data. A journalist

compared the piece to hearing the original *William Tell Overture* on a record player at the wrong speed, or played by the Portsmouth Sinfonia³⁸ (Buttall, 2017). It is obvious that an emotional connection is created with the piece as it evokes a range of emotions for the audience.

The comicality appears as the original is changed in a way that is perceived as 'wrong' or 'played badly'; when it transgresses its 'original' style and performance context. Modulations, for example, do not produce as much laughter as beating dissonances because they are accepted within the Classical style. The effect created is comparable to that of 'Replacement Remixes' even though the approach differs, with a more detailed approach to the changes afflicted to the original piece.

The use of humour in a musification of climate change data can be an interesting opportunity to engage listeners with the subject matter. Education on climate change for the general public can be hampered by numerous factors which prevent them from modifying their own behaviour and adopting more environmentally friendly habits. Some of the barriers include 'Lack of knowledge', 'Climate change is a distant threat', 'Perceived information over-load' and 'Fatalism' (Lorenzoni, 2007, pp. 450-451). The use of music and humour might offer the key to addressing these issues, particularly the latter two. While listening to *Wasgiischwashäsch* only provides some information on climate change in Switzerland, it can encourage a listener to seek out further information. More interestingly though, engaging with climate change through sound rather than

³⁸ Founded in 1970 at the Portsmouth School of Art, the Portsmouth Sinfonia invited musicians with no or little musical or instrumental training to join and play Classical repertoire. It should be noted that the Portsmouth Sinfonia was not intended as a spoof or joke, rather, it invited musicians with no skill in their chosen skill to perform classical repertoire (Wilsher, 2004). The musical result has however attained cult comedic status.

images can help overcome the visual information over-load and potentially create a deeper emotional connection. Furthermore, the possibility of provoking laughter while presenting a serious topic might help overcome a feeling of fatalism or extreme seriousness.

To conclude, the parallels in audience feedback between the musical borrowing described here and 'Replacement Remixes' show the potential for 'musical borrowing sonifications' to engage audiences more effectively. By provoking emotions such as laughter and concern, they can overcome the climate change 'burnout' that might be felt by listeners who are repeatedly exposed to information on climate change and therefore become less responsive to those stories.

6.7 Information Transmission Process

The musical borrowing of a universally known piece enhances information transmission process by bypassing some of the steps in the process. In fact, by using known musical sources, sonification designers can create a more efficient sonification learning process.

Because of the *William Tell Overture's* familiarity, changes to its original score are noticed by the listener. As the piece becomes further distorted from the original, it also becomes obvious that the data probably is significantly changing. The listener's musical knowledge about repertoire and emotional connotations are harnessed for the purpose of information transmission. The advantages and challenges of using a known musical language, and its connotations, were discussed in 2.3.3. In this case, not only a musical language is harnessed, but an entire work with its own set of connotations.

6.7.1 Shannon-Weaver Mathematical Theory of Communication

The Shannon-Weaver Mathematical Theory of Communication, which describes the way in which ‘one mind may affect another’, it includes music as a form of communication (Shannon and Weaver, 1949, p. 3). The model they describe was intended for the improvement of telecommunications but has interesting applications in other areas. While it is of interest to any composer to understand the process by which a message might be transmitted to a listener, the model also offers interesting parallels to the sonification process. In fact, it helps to explain why the use of shared knowledge in the design of a sonification can improve the information transmission process.

Shannon and Weaver describe the communication process as a system that includes five parts: an *information source*, a *transmitter*, a *channel*, a *decoder* and a *destination* (Shannon and Weaver, 1949, p. 33-34). The system can also contain *Noise*, which is any interference to the signal which creates ‘distortions’ or ‘errors in transmission’ (Shannon and Weaver, 1949, p. 8). In telecommunications, Noise will most likely occur at the channel stage. *Feedback* denotes the return message from the destination (receiver) to the information source (sender); it was introduced by later theorists (Chandler, 1994).

The Shannon-Weaver model can be applied to sonification: the information source is the sonification *designer*, the transmitter (or encoder) is the *mappings*, the channel is the *musical language*, the decoder is the *knowledge* of the mappings and musical language used, and the receiver is the *Listener*. Table 6.2 shows all the parallels between the general model and the model as applied to sonification. The process is shown as a chart in Figure 6.5.

Tab. 6.2: The Shannon-Weaver model is described on the left, it is applied to the process of sonification on the right.

Shannon-Weaver	Sonification
<p>'An <i>information source</i> which produces a message or sequence of messages to be communicated to the receiving terminal' (Shannon and Weaver, 1949, p. 33). An <i>information source</i> acts as the <i>Sender</i> of a <i>Message</i>.</p>	<p>The sonification <i>Designer</i> (Sender) sends <i>Information</i> (Message) to a <i>Listener</i> (Receiver).</p>
<p>'A <i>transmitter</i> which operates on the message in some way to produce a signal suitable for transmission over the channel' (Shannon and Weaver, 1949, p. 33). A <i>Transmitter</i> which is the <i>Encoder</i> of the <i>Message</i> that becomes a <i>Signal</i>.</p>	<p>The <i>Mappings</i> (Encoder) produce a <i>Sonification</i> (Signal).</p>
<p>'The <i>channel</i> is merely the medium used to transmit the signal from transmitter to receiver' (Shannon and Weaver, 1949, p. 34). A <i>Channel</i> is the <i>Medium</i> which transmits the signal.</p>	<p>The <i>Musical Language</i> (Channel) is the medium through which the <i>Sonification</i> (Signal) is transmitted.</p>
<p>'The <i>receiver</i> ordinarily performs the inverse operation of that done by the transmitter, reconstructing the message from the signal' (Shannon and Weaver, 1949, p. 34). The <i>Decoder</i> reconstructs the <i>Received Signal</i> as a <i>Message</i>.</p>	<p>The knowledge of the <i>Musical Language</i> and <i>Mappings</i> used (Decoder) decrypt the <i>Sonification</i> (Signal).</p>
<p>'The <i>destination</i> is the person (or thing) for whom the message is intended' (Shannon and Weaver, 1949, p. 34). The <i>Receiver</i> gets the <i>Message</i>.</p>	<p>The <i>Listener</i> (Receiver) receives the <i>Information</i> (Message).</p>

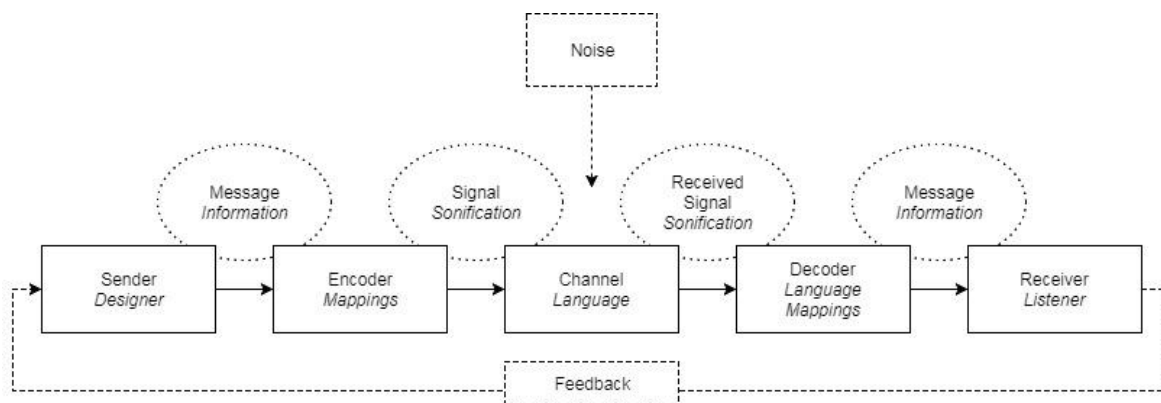

Fig. 6.5: Shannon-Weaver Mathematical Theory of Communication applied to the sonification process (in italics). The terms in boxes describe the five parts of the communication process, while the annotated arrows describe the transmission between parts. Noise is an external influence on the channel which can distort the signal and the feedback describes the message returned from the Receiver to the Sender.

6.7.2 Noise and Feedback

The concept of Noise in the Shannon-Weaver model refers to any ‘changes in the transmitted signal’ (Shannon and Weaver, 1949, p. 8). In purely functional applications of sonification, one would aim for a noiseless channel so that the message is sent without distortions. What is Noise in a sonification signal and how do we evaluate it? Many factors can hamper the complete transmission of a sonification. Unsuitable mappings or musical language might distract the listener or difficult the understanding of the message. A musification necessarily contains Noise as its musical structures and artistic purpose introduces more subjectiveness to its perception. However, this is not a weakness of a musification, but rather a by-product. This will be explored in more depth in Chapter 7 which discusses the evaluation of musification.

Feedback refers to the return message from the Receiver to the Sender which ‘enables speakers to adjust their performance to the needs and responses of their audience’ (Chandler, 1994). This is desirable in many settings where the Sender needs the Receiver’s feedback, for example in medical settings. In an artistic context, the idea of feedback is often more difficult to quantify, particularly in real-

time. During a performance, a performer might adjust to the audience's feedback if the performance context allows for it, for example during a rock concert. However, it is unlikely that the feedback significantly changes a symphony orchestra's concert. In a piece such as *The Voice of the Sea*, where compositional decisions are made in real time, feedback can influence the performance. However, this is unlikely to be the case or *Wasgiischwashäsch*.

In the context of musification, feedback can be given by the audience during or after the performance. While this feedback is important and has influenced subsequent pieces in the project, none of the pieces rely on a 'feedback loop', where the piece is continually adjusted to the audience's reaction.

6.7.3 Context in the Shannon-Weaver Model

Information is data coupled with context (Roddy and Furlong, 2014, p. 75); so, the Message consists of Data and Context. The equivalence of the Message as Information needs to be further deconstructed. The Message contains Data but needs context in order to become a Signal or Sonification which can be understood by the Receiver or Listener. The Context of the Information is contained by the Message, Encoder and Channel, all of which contain the Data, Mappings, Language and Emotional Content of the Sonification. In fact, these elements provide context to a dataset.

Let us reconsider the Shannon-Weaver model as applied to sonification by adding the elements of the sonification framework which contain context:

- 1) The Designer sends a Message which contains Data. A dataset has a Context which needs to be transmitted. The emotional connotation of the dataset determines the *Emotional Content* of the sonification signal.
- 2) The Mappings are chosen as to best transmit the Data and its Context.

- 3) The Musical Language is chosen to act as an appropriate medium to transmit the Sonification.
- 4) The Decoder understands the context provided by the Musical Language and Mappings to decrypt the Sonification.
- 5) The Listener receives the Sonification and its Context and can understand the Data and its Emotional Content.

The communication process of the Sonification implies that the Sender transmits the Data and the Context of the Information, and the Receiver gets the Sonification and its Context. Where the Sender and the Receiver have a shared knowledge of the Context, the Signal can be decrypted without needing to learn the Context. So, the shared knowledge of the Mappings, Language and Emotional Content enables a more efficient information transmission process because there is no need for learning. If the Receiver understands the Data, Mappings, Musical Language and Emotional Content, they are able to decrypt the Received Signal.

When the Receiver shares an understanding of the context with the Sender, the communication process becomes more effective. In practice, the practice of musical borrowing in sonification functions as a shared knowledge of the context. When the Listener understands the musical language, emotional connotations and mappings (that is the changes applied to the original piece), the decoding process is simplified. Their knowledge of the borrowed piece enables them to skip steps in the model. Therefore, the use of musical borrowing of sonification can constitute an important improvement in the information transmission process of aural display.

6.8 Conclusions

This chapter describes the compositional process of *Wasgiischwashäscht* which uses Rossini's *William Tell Overture* as a sound source for the mappings used to communicate data on climate change in Switzerland. It is described as a successful example of a musification as it effectively transmits the data and its message, elicits an emotional response, and can be considered as a self-contained piece of music.

We have discussed the compositional process involved in transmitting information by mapping data parameters to musical parameters of an existing musical source. The approach has a great advantage over mapping to sound parameters of an original piece of music, as the listener's existing knowledge about the music can be harnessed to make the information transmission process more effective by removing part of the sonification learning process. This method requires musical knowledge and compositional skills and is not as accessible as more conventional data-to-sound mapping approaches.

We have also suggested that the use of musical borrowing might catch the public's attention as it shows similarities to the recent trend of Replacement Remixes. The entertaining and sometimes amusing aspect of the distortion of the original piece can be an attraction. There is however a danger of creating a novelty rather than a respectable piece of music; the sonification needs to be musically and scientifically sound to be heard as more than just a gimmick.

Wasgiischwashäscht is the culmination of the practice element of the project. It incorporates findings from the three previous pieces and their analysis to create a musification which is equally engaging from a musical and scientific point of view. This conclusion has been reached through empirical dissection of the work.

Chapter 7

An Evaluation Framework for Musification

There are neither ‘specific guidelines’ on developing sonifications, nor on related evaluation methods and criteria (Ibrahim et al., 2011, p. 77). The field of sonification still lacks rigour in systematic statistical evaluation, while any sort of evaluation is rarely applied to musification. Even if sonification is becoming a ‘mature field’, it still ‘is fighting against being considered just as an amusement experiment or a pseudo-science by the audio scientific community’ (Degara et al., 2013, p. 167). Adopting a ‘methodical research approach’ with a ‘benchmarking framework that allows for the comparison of sonification algorithms’ (Kramer, 2004; in Degara et al., 2013) is part of the solution to raise the quality and profile of the field.

Some argue that an artistic approach to sonification might not need to be evaluated (Williams, 2016; Degara, et al., 2013). However, a lack of evaluation means a lack of quality control and therefore, a lack of accountability in the work of scientists and composers. At its worst, musification is used to attract audiences to sub-standard work; see also the discussion on ‘conversion hysteria’ in 2.4.3 (Connor, 2013, p.10). The Higgs-Boson particle sonification described in 2.7.5 (Pesic and Volmar, 2014), for example, reached large international audiences but in fact skews the sonification process to suit the desired aesthetic outcomes. At other times, the listener might not be able to receive or decipher information; the sonification method becomes a programme note and redundant (a musification

should explicitly use sonification and enable an information transmission process with the audience).

This thesis proposes a compositional framework for musification in order to further the field and facilitate access to the practice. Consequently, a solid evaluation framework for musification should also be developed and applied. As the method of musification combines functional aural display with musical meaning, language and structure, its evaluation requires a quantitative and qualitative approach, but also a combined approach. The framework proposed is supported by practice-as-research, the analysis of the musification portfolio, but is not yet demonstrated. Its application to the portfolio is a first step in testing it but more work is required in order to fully demonstrate it.

7.1 Evaluating Sonification

Surveys of sonification papers report a low number of projects which carried out statistical evaluation on functional sonifications (Vogt, 2011; Degara, 2013; Ibrahim et al., 2011). While there are no established evaluation methods for sonification, 'end-user testing with at least a working prototype' (Ibrahim et al., 2011, p. 79) is a common approach for evaluation. Examples of tasks used include matching, comparison, classification, ordering, association, prediction, finding, memorisation, navigation and identification tasks (Ibrahim et al., 2011, pp. 79-81).

Evaluating sonification presents a range of unique challenges. It can be difficult to find enough participants to obtain statistically relevant results. It is also rare to find sufficient participants who are willing and knowledgeable enough 'to assess the sonification for both its sonic and domain science value' (Vogt, 2011).

Furthermore, participants often complete tests on different equipment and in potentially noisy environments (Degara et al., 2013, p. 170). Tests in a laboratory environment need to be combined with testing in the implementation environment, as ambient noise can distort results collected in a neutral environment (Bonebright and Flowers, 2011, pp. 111-13). A final challenge worth mentioning is the importance of aesthetics in auditory display evaluation. While aesthetics is an important consideration in sonification design, it remains a subjective perception and must be weighted and combined with more objective criteria (Degara et al., 2013, p. 70).

7.1.1 Sonification Evaluation Criteria

Existing sonification evaluation criteria are surveyed briefly to determine their usefulness for musification. The discussion will inform the proposed set of criteria for the evaluation of musification.

Hermann

The first question in a sonification evaluation might ask whether the auditory display is indeed a sonification. Hermann proposes that the following criteria must be fulfilled (2008, p. 2):

(C1) The sound reflects *objective* properties or relations in the input data.

(C2) The transformation is *systematic*. This means there is a precise definition provided of how the data (and optional interaction) cause the sound to change.

(C3) The sonification is *reproducible*: given the same data and identical interactions (or triggers) the resulting sound has to be structurally identical.

(C4) The system can intentionally be used with *different data*, and also be used in repetition with the same data.'

This framework tests the definition of a sonification but not its qualitative characteristics.

Vogt

Vogt proposes a multi-criteria decision aid for evaluating sonification which takes ‘different stakeholders’ into account (in this case, domain scientists, sonification experts, and media artists). This allows the sonification designer to evaluate the sonification design objectively and draw conclusions on which kind of sonification is appropriate for the end user (Vogt, 2011). The proposed criteria are shown in Table 7.1.

Tab. 7.1: Sonification evaluation criteria proposed by Vogt (Vogt, 2011).

Criterion	Description
Gain	How much is gained by the sonification, e.g. in comparison to other displays or classical methods?
(Gestalt) Clarity	How clearly can differences and interesting structures be perceived in the sonification?
Learning effort	How long does it take to comprehend the sonification and to be able to make use of it?
(Sound) Amenity	How aesthetically pleasing (as opposed to annoying) is the sound?
‘Contextability’	Is the sonification applicable in its context (e.g., scientific exploration, public outreach, work environment, etc.) [?]
(Task & data) Complexity	How complex (or ‘non-trivial’ did you think the task or underlying data were (<u>not</u> the sonification or sound!)?
Technical effort	How much technical effort did the sonification require?

The criterion of ‘gain’ can be understood as the questioning of a musification’s reason for being. If a listener hears a musification but does not know that it is one, what do they gain from hearing it? What does the piece gain from having been written through the sonification process? The question of ‘clarity’ is complex

because musification does not have information as sole purpose, therefore the question of clarity might be weighted less heavily than for a purely functional sonification. One might however ask how the data has been translated musically – whether there is any interesting correlation between data and sound which produce an interesting musical structure or event. The ‘learning effort’ required to understand a sonification and the information it transmits can be understood through the information transmission process described in 6.7. This criterion necessarily influences the clarity of the sonification, particularly if the listener only hears the musification once, for example at a concert.

Sound ‘amenity’ is treated in a simplistic manner in Vogt’s criteria as it is reduced to aesthetically pleasing (desirable) or not (undesirable). While ease of listening is important for many applications, a disturbing effect might be desirable for an alarm sound. In music, pleasing aesthetics are only a part of the creative opportunities. We have seen that aesthetics does not equal pleasantness, and that music is not necessarily pleasant even if aesthetic. Therefore, aesthetics is a more appropriate term in discussing musification, rather than just amenity. The neologism ‘contextability’ refers to context in which a sonification is used, or the setting in which a musification is played. It is a useful criterion as it asks whether the musification is appropriate for its intended purpose through its musical language, structure, etc.

The two final criteria – complexity and technical effort – will not be considered as they are less relevant in the context of a musification than that of a functional sonification. Complexity refers to the complexity of the underlying task and data of a sonification; this criterion can be important when evaluating the ease of handling a complex task through aural display. The technical effort criterion

evaluates how much technical effort was required to produce the sonification. Again, this might be important when used in a functional environment. In a musification, we would argue that the aesthetic result takes precedence over the technical effort required to achieve it.

Williams

Williams proposes the definition of musification as a sonification which uses musical constraints and structures to facilitate the understanding of data (Williams, 2016). While they use musical aesthetics, his musifications are designed for functional purposes in a biomedical context. However, the criteria are interesting because they take aesthetics into account. Williams proposes the criteria shown in Table 7.2.

Tab. 7.2: Sonification evaluation criteria proposed by Williams (Williams, 2016).

Criterion	Description
Amenity	Was the musification audibly “pleasant”?
Immersion	Were listeners able to give the data their full attention?
Intuitivity	How readily analysable was the resulting musification with no specific training?
Efficiency	How quickly could listeners identify a change in flagellar movement using the musification?
Congruency	How aesthetically appropriate the musification was when presented synchronously with the visual representation?

We have previously discussed the importance of aesthetics in sonifications, as they can heavily influence the experience of the user. Amenity is often a desirable quality in an aural display, particularly as it has been shown to improve user satisfaction (Leplâtre and McGregor, 2004). However, less pleasant sonification

is also at times very necessary, for example, when used as an alarm. If the criterion of amenity, where pleasantness is considered a positive, is somewhat lacking even for functional uses, sonification for artistic uses needs a more complex and encompassing aesthetical criterion.

7.2 Evaluating Music

Before proposing evaluation criteria for musification, we must shortly discuss the evaluation of music. In 2.5, we have defined music as *organised sound which has been determined to be musical*. We have also shown that some consider that music cannot or should not be evaluated, perhaps because of a romanticised view of composition as a genial act of inspiration rather a learned craft. Much of the skill of musical composition relies on learned techniques which must be honed and applied patiently; inspiration is only a part of the process. Consequently, many aspects of music can be evaluated with some objectivity. However, we can probably never ‘completely’ evaluate a piece of music because words are insufficient to fully encompass the feeling and meaning of music. Two excellent critics might disagree on a given piece, despite their shared knowledge of music. Furthermore, the physiological differences between individuals simply negate the possibility of a truly identical experience. Nevertheless, the need for evaluation frameworks for music exists and evaluation is possible.

7.2.1 Lack of contextualisation

The way most composers create – in isolation - means that they do not contextualise their work sufficiently and do not evaluate it comparatively. Landy describes this issue with a focus on electroacoustic music (1999, p. 63):

[I]ndividuals staking their claim to an idea, an approach or some such often without adequate contextualisation, but more importantly here without adequate or any feedback or consistent correlation, using methodologies that are often self-referential.

Landy refers to composers who integrate scientific methods in their work, for example. Most of the research and evaluation carried out by composers is based 'action research' or practice-as-research methodologies and happen 'ad-hoc' (Jordanous, 2012, p. 3). This can explain why they can lack contextualisation. Landy aims for more thorough scholarship; this thesis is a step towards creating a methodology and evaluation framework for the use of sonification in composition.

7.2.2 GCSE Assessment Criteria

To determine which parameters can be evaluated with some objectivity, it might be useful to look at the assessment criteria for the General Certificate of Secondary Education (GCSE)³⁹. The Music examination includes a composition element which consists of a composition to a brief and a free composition. Table 7.3 shows the criteria against which the pupils are assessed. We can see that they are mostly based on concepts found in Western Classical music, with a focus on harmony and form. The evaluation of such specific concepts in the context of musicification research would be too restrictive as it would only allow for limited creative possibilities. In fact, most of the portfolio could not be judged through this lens. However, the GCSE assessment scheme demonstrates that some objective criteria exist while more subjective criteria can be assessed qualitatively, particularly in comparison to other pieces written to the same brief. This is why

³⁹ GCSE examinations are used in England, Wales and Northern Ireland. Pupils usually take them in Year 11, when they are 15 years old.

statistical evaluation of a number of musifications can be useful despite the subjective nature of music composition.

Tab. 7.3: Composition assessment grid for GCSE examinations of the AQA examination board (AQA, 2018, pp. 23-24 and pp. 42-48).

Requirement	Instruction								
Number of pieces	2								
Length of pieces	Combined time of 3 minutes								
Programme note	150 words: clearly informs the assessor of the compositional intention, including the intended audience/occasion. Students must also identify the types of musical element selected and provide details of any software and hardware used in their compositional process.								
2 categories from which 4 elements must be chosen									
Select and use 4 types of musical elements from 2 categories	<table border="0"> <tr> <td>Rhythm, metre, texture, melody, structure, form</td> <td>Harmony, tonality, timbre, dynamics, phrasing, articulation</td> </tr> <tr> <td> <p>Rhythm, metre: change of metre, compound time, augmentation, diminution, cross rhythm, syncopation, dotted rhythms, triplets, rubato, tempo change</p> </td> <td> <p>Harmony, tonality: perfect, plagal, imperfect and interrupted cadences, major and minor tonality, modal tonality, diatonic harmony, inverted chords, modulation, 7th chords, dissonance, pedal or drone, chromatic harmony</p> </td> </tr> <tr> <td> <p>Texture, melody: homophonic texture, polyphonic texture, scalic, triadic conjunct and disjunct movement, ornamentation, ostinato or riff, improvisation, imitation, canon, antiphonal texture, blue notes, passing notes</p> </td> <td> <p>Timbre, dynamics: single instruments and/or voices, instrumental groupings and/or vocal groupings, synthesised sounds, computer-generated sounds, crescendo and diminuendo, reverb, tremolo, distortion, vibrato, falsetto</p> </td> </tr> <tr> <td> <p>Structure, form: rondo, arch shape, theme and variations, minuet and trio, strophic, through composed, sonata, ground bass, popular song form, blues</p> </td> <td> <p>Phrasing, articulation: legato, staccato, tenuto, marcato, accent, slurring, arco, pizzicato, tonguing</p> </td> </tr> </table>	Rhythm, metre, texture, melody, structure, form	Harmony, tonality, timbre, dynamics, phrasing, articulation	<p>Rhythm, metre: change of metre, compound time, augmentation, diminution, cross rhythm, syncopation, dotted rhythms, triplets, rubato, tempo change</p>	<p>Harmony, tonality: perfect, plagal, imperfect and interrupted cadences, major and minor tonality, modal tonality, diatonic harmony, inverted chords, modulation, 7th chords, dissonance, pedal or drone, chromatic harmony</p>	<p>Texture, melody: homophonic texture, polyphonic texture, scalic, triadic conjunct and disjunct movement, ornamentation, ostinato or riff, improvisation, imitation, canon, antiphonal texture, blue notes, passing notes</p>	<p>Timbre, dynamics: single instruments and/or voices, instrumental groupings and/or vocal groupings, synthesised sounds, computer-generated sounds, crescendo and diminuendo, reverb, tremolo, distortion, vibrato, falsetto</p>	<p>Structure, form: rondo, arch shape, theme and variations, minuet and trio, strophic, through composed, sonata, ground bass, popular song form, blues</p>	<p>Phrasing, articulation: legato, staccato, tenuto, marcato, accent, slurring, arco, pizzicato, tonguing</p>
Rhythm, metre, texture, melody, structure, form	Harmony, tonality, timbre, dynamics, phrasing, articulation								
<p>Rhythm, metre: change of metre, compound time, augmentation, diminution, cross rhythm, syncopation, dotted rhythms, triplets, rubato, tempo change</p>	<p>Harmony, tonality: perfect, plagal, imperfect and interrupted cadences, major and minor tonality, modal tonality, diatonic harmony, inverted chords, modulation, 7th chords, dissonance, pedal or drone, chromatic harmony</p>								
<p>Texture, melody: homophonic texture, polyphonic texture, scalic, triadic conjunct and disjunct movement, ornamentation, ostinato or riff, improvisation, imitation, canon, antiphonal texture, blue notes, passing notes</p>	<p>Timbre, dynamics: single instruments and/or voices, instrumental groupings and/or vocal groupings, synthesised sounds, computer-generated sounds, crescendo and diminuendo, reverb, tremolo, distortion, vibrato, falsetto</p>								
<p>Structure, form: rondo, arch shape, theme and variations, minuet and trio, strophic, through composed, sonata, ground bass, popular song form, blues</p>	<p>Phrasing, articulation: legato, staccato, tenuto, marcato, accent, slurring, arco, pizzicato, tonguing</p>								

7.2.3 'Something to hold on to' factor

Landy coins the term 'something to hold on factor' by which he describes 'useful musical devices that support the listening experience' (Landy, 2007, p. 23). When listening to a musical style they are unfamiliar with, listeners need 'something to hold on to' in the music, something which they can comprehend. He sums up the need for these 'access tools' as follows:

Reading postgraduate theses, programs, and liner notes, one tends to discover the formulae, often obscure and in most cases inaudible, that lead to the construction of the piece, or, one or more aspects that inspire a work, but which are, again, not necessarily to be discovered by listening. [...] What is missing is the articulation of musical content and structuring devices that can be shared or discovered that would thus aid willing listeners in terms of accessing works. (Landy, 2007, p. 23)

Landy identifies a range of 'access tools which can be used in electroacoustic music. This idea is useful in the field of musification too. As we have previously asked, if the listener does not hear and understand the sonification within the piece, what is the function of the musification? In fact, the sonification aspect of the musification might actually provide an access point for the novice listener. The incorporation of the 'something to hold on to' factor in the evaluation of musification will be further discussed in 7.3.

7.2.4 Musical Evaluation in Musification

Quantitative and qualitative evaluation of music is possible, up to a point. Evaluation criteria are often linked to musical styles and their associated rules, which makes it difficult to establish definitive criteria for musification as it describes a method rather than a musical genre or style. A more thorough discussion around the evaluation of music is beyond the scope of this project which focuses on musification as a methodology; the question of this evaluation

is raised but is not the main objective. The proposed criteria are an attempt to provide an answer to this question but we must be aware of their limitations due to the very nature of music.

7.3 Evaluating Musification

Evaluating musification involves the evaluation of sonification, music, and the parameters arising from their amalgamation.

7.3.1 Combining Existing Musification Criteria

Some evaluation criteria for musification can be found in the analysis of the 2003 *Listening to the Mind Listening* (LML) competition which resulted in a concert of sonifications using the same EEG dataset. The brief specified that they had to be 'data-driven', 'time-binding' and 'reproducible' (Barrass et al., 2006, p. 13). Twenty-seven pieces were blind-reviewed to select the ten concert pieces. The criteria used were 'aesthetics', 'mapping', 'accessibility' and 'overall impression' and they were marked on a scale from 1 to 5 (Barrass et al., 2006, p. 14). These are more appropriate for musical sonification than previously discussed criteria because of their focus on aesthetics, rather than amenity, and the listener reception. The *LML* project is unique in that it provides a range of sonifications based on the same dataset. This is a rare occurrence, as composers usually strive to create original and individual work.

Eacott's sonification piece *Flood Tide* was evaluated through a discussion with audience members (Eacott, 2012). No specific evaluation criteria were used; the listeners were asked what they liked, or not, about the piece.

The evaluation criteria proposed by Vogt, Williams and Barrass have been aligned in Table 7.1. Additionally, five overarching criteria are proposed. These

incorporate and combine most of the existing criteria, while filling gaps specific to musification.

Tab. 7.4: Comparison of evaluation criteria of sonification and musification respectively, as found in Vogt, 2011; Williams, 2016; Barrass et al., 2006; and proposed criteria for musification evaluation.

Vogt	Williams	Barrass	Proposed criteria
Gain	/	/	Gain
Clarity	Intuitivity, Efficiency		Intuitivity, clarity and learning effort
Learning effort	/	Accessibility	
/	/	Mapping	Sonification method
Amenity	Amenity	Aesthetics	
Contextability	Congruency	/	Aesthetics
/	Immersion	/	
/	/	Overall Impression	Audience feedback

The *Gain* criterion is only mentioned by Vogt but is crucial in discussing musification. The purpose of a sonification, whether purely functional or with artistic intentions, determines most of the compositional decisions involved in its creation. The evaluation of its quality needs to ask whether the aesthetics serve its purpose. A sonification which accompanies a visualisation, for example, will be evaluated for the congruency between sound and image: what does the visualisation gain from the musification, and vice-versa? The concept of congruency, as described by Williams, is also included in the category of ‘aesthetics’, as we will see shortly. Vogt’s criterion of ‘contextability’ (‘Is the sonification applicable in its context [...]?’ (Vogt, 2011)) can similarly be used both for the ‘gain’ and ‘aesthetics’ criteria. The first one asks whether the context of

the sonification is appropriate, the other one asks how the sonification has been embedded in this context.

The second category includes *Intuitivity, clarity and learning effort*; it combines Vogt's 'clarity' and 'learning effort', Williams' 'clarity' and Barrass' 'accessibility'. This category asks whether the information transmission process is efficient. It also asks which learning effort the sonification requires and whether it is accessible to a wider audience. In the context of musification, one might ask how the musical structure affects the information transmission process.

Interestingly, only Barrass et al. discuss the criterion of 'mappings' which is part of the wider criterion of *Sonification method*. It evaluates the methodology of a sonification, so we can apply it to the Data-Mappings-Language-Emotion framework and how it has been applied. Where the sonification method is rated as poor, one might ask whether this serves a musical purpose; can the skewed sonification method be justified in the wider context of the musification?

The choice of *Aesthetics* as a criterion instead of amenity has been amply discussed already. This category does not only include the musical aesthetics of the musification but also examines the larger context of the piece. The concept of 'congruency' fits under the umbrella of aesthetics too; an empathetic sonification must take into account the context of the data. Vogt's concept of 'contextability' can also be regarded as a matter of aesthetics as it asks how the aesthetics are embedding the sonification in its context. Finally, Williams' concept of 'immersion' determines whether the listener feels immersed in the sonification experience; this can be considered as a subcategory of 'contextability', when the context is that of an immersive experience.

Finally, *Audience feedback* is proposed as a fifth criterion because music is an information transmission process which usually includes feedback from listeners, musicians, critics, etc. This aspect has been emphasised in the work of Barrass et al. but also Eacott as they seek to create artistic products. This criterion is related to all previous ones as they feed into the overall experience of the audience. It must be noted that the feedback might come from very different groups with differing knowledge about sonification, music and science. Also note that this feedback is not collected in a controlled environment as performance contexts and audiences vary; this is inevitable in this case. It is felt that all feedback is valuable however, as musification has a functional and an artistic purpose which reaches a wide range of listeners. In fact, a variety of feedback is useful to the scientist-composer because it informs their work in designing the information transmission process; the receiver *must* be taken into consideration by the sender.

7.3.2 Description of Proposed Criteria

The five criteria described above – Gain, Intuitivity, clarity and learning effort, Aesthetics, Sonification method, and Audience feedback – are listed with accompanying questions in Table 7.5. They provide a way of attributing a rating to each criterion. Two types of rating are required: artistic and functional. This is because the evaluation chart proposed in 2.6, and below shortly (Figure 7.1), has an artistic and a functional axis. The proposed questions will allow the attribution of a rating from 1 (lowest) to 5 (highest); the ratings will be averaged for each criterion in order to plot each piece of the portfolio on the evaluation chart.

Tab. 7.5: Proposed evaluation criteria for musification, questions used to attribute ratings, and artistic (A Rating) and functional (F Rating) rating.

Proposed criteria for musification evaluation		
Is it a musification?	Does it satisfy the criteria to be a sonification? Does it use musical structures and does it have an artistic purpose? If yes, proceed to the evaluation criteria.	Yes or no
Gain	What does the sonification gain from using musical structures? What does the music gain from using a sonification? Does the musification serve a purpose?	A(rtistic) Rating: F(unctional) Rating:
Intuitivity, clarity and learning effort	Are the data and the information clearly heard? Is the sonification accessible? What does the listener need to know or learn to understand the data and the music? Is the sonification process explicit?	A Rating: F Rating:
Aesthetics	What is the aesthetic and is it well executed? Does the aesthetic suit the needs of the sonification? Is the musification congruent with the data, so that the data are transmitted empathetically? How is the sonification integrated in the music? Are there other musical elements?	A Rating: F Rating:
Sonification method	Does the musification fulfil the requirements for a sonification (objective, systematic, reproducible, different data)? If not, why and to what extent? Can the deviations be justified for aesthetic reasons? <u>Data</u> : Are the data suitable for sonification? Do the data have a musical structure? Can their information be transmitted musically? <u>Mappings</u> : Are they musically interesting? Do they best transmit this information (clearly, precisely, aesthetically)? <u>Musical Language</u> : Is the form and instrumentation/sound world suited to this dataset? <u>Emotional Content</u> : Does it elicit the intended emotional response from the listener? Is it a piece of music in its own right?	A Rating: F Rating:
Audience feedback	What did the audience hear, understand and feel? How did they judge all the above criteria?	A Rating: F Rating:

7.3.3 Evaluation Chart

An evaluation chart was proposed in 2.6 (Figure 7.1) to describe the artistic-functional space which a musification must occupy to qualify as such. The evaluation criteria and rating scale associated will enable us to determine whether an aural display or musical piece is a musification, and where it ranks in the chart. To recapitulate, the chart has an axis for the artistic quality and one for the functional quality of the aural display. The dotted rectangle shows the area which qualifies as a musification; it allows for sonifications which might lean towards one of the two axes, while fulfilling minimum criteria on both. If it fails any of the criteria, and is given a 0 rating, it will fall outside the dotted rectangle and will not be considered a musification. If it is a musification, the 1-5 rating on each axis will give the geometric location of each piece. The 'ideal' musification would be one in position (5,5) but any musification falling within the rectangle is acceptable as such. Therefore, the evaluation chart allows for musification of differing quality, as long as they fulfil the necessary criteria to qualify as such.

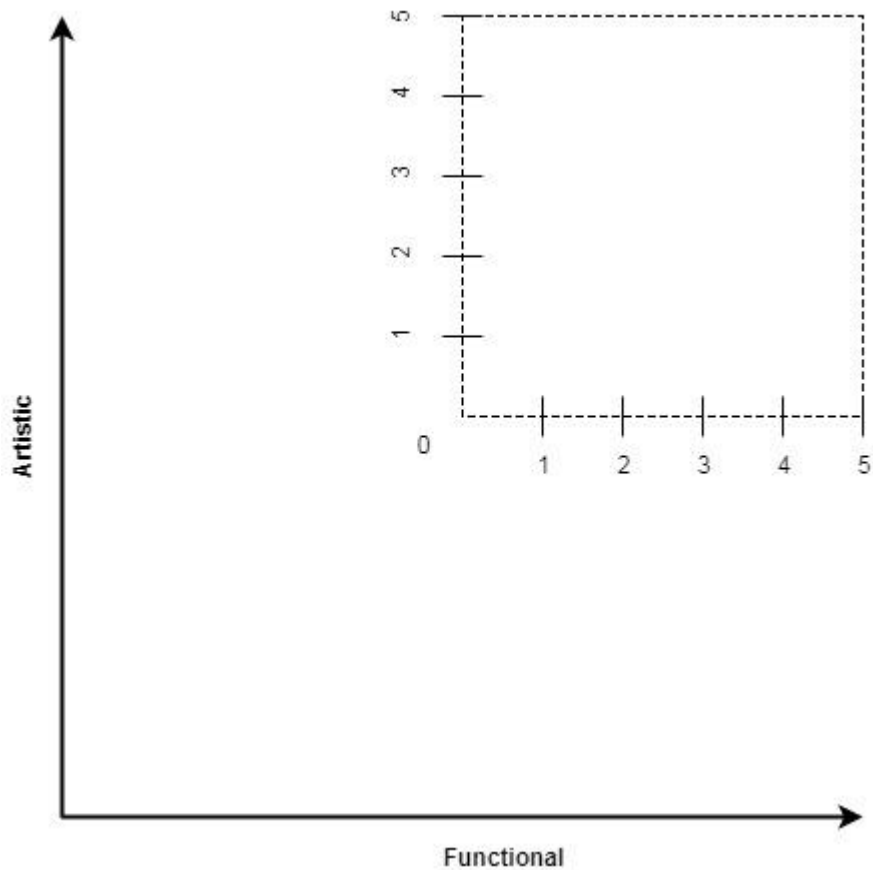

Fig. 7.1: Evaluation chart for musification.

7.4 Conclusions

We have shown the need for an evaluation framework for sonification and more specifically musification. The evaluation methodology provides a vocabulary and structure to rate musification – while taking the ultimately subjective and non-verbal nature of music into account. The use of this approach will hold creators accountable and raise the quality and reputation of the field.

We have proposed a framework which evaluates five criteria: Gain, Clarity, Intuitivity and learning effort, Aesthetics, Sonification method, and Audience feedback. These have been derived from existing criteria for sonification and musification, and adapted for the needs of musification as defined for this project.

These criteria can then be used to plot a piece on an artistic-functional evaluation chart.

It will be of interest to use the proposed methodology in a wider range of settings in order to refine it; this includes a larger set of pieces in different styles and of lower perceived quality in order to explore the limitations of the framework. It would also be interesting to investigate its application by different users to the same pieces to test the deviation in scores. Unfortunately, this falls outside the scope of this project. Nevertheless, the proposed evaluation framework is an important step towards an evaluation method for musification and it is expected to be developed further.

Chapter 8

Conclusions

This chapter concludes the thesis by summarising the results and conclusions reached during the project. These are compared to the research questions raised in Chapter 1. Finally, contributions to knowledge and recommendations for future work are listed.

8.1 Summary

This thesis has explored the use of sonification as a compositional tool within the practice of musification. Through a practice-as-research methodology, the project has resulted in a portfolio of four pieces using climate change, environmental and dark matter data. The analysis of the portfolio has been used to develop a framework for composition with sonification, define the concept of musification, and propose evaluation criteria for musification.

8.1.1 Research Questions

The research questions posed in 1.3 have been addressed as follows:

Can sonification be used as a compositional tool, particularly for electroacoustic composers? What differentiates a musification from a sonification and what are its uses and characteristics?

The literature review in Chapter 2 discussed previously existing work using sonification as a compositional tool, and preliminary findings on the musical possibilities of sonification. The proposed solutions to the field's shortcomings, as highlighted in this chapter, were explored through my creative practice by

composing four musifications. Chapters 3 to 6 describe and analyse these pieces and conclude that they satisfy the definition of a musification: a sonification with musical constraints and for artistic purposes. It can be concluded that sonification can indeed be used as a compositional tool, when used with appropriate data, mappings, musical language and emotional content; this is the compositional framework proposed in 3.7.

Three of the four pieces used electroacoustic music as a medium. The different styles used - acousmatic (Chapter 3), audio-visual (Chapter 4) and live electronics (Chapter 5), responded to the needs of each dataset but also demonstrated the creative possibilities of sonification as a tool for electroacoustic music. The fourth piece is an *orchestral sonification* which uses Western classical music conventions (as is usual in sonification) but was written by hand rather than with the help of a computer; the opportunities and challenges of this approach are described in Chapter 6.

Musification has been defined in 2.6: 'Musification is a sonification which follows some sort of musical constraints while also existing as a piece of music.' This definition is an amalgamation of opinions found sonification literature and has been applied to each piece in the portfolio. When asking whether a work is a sonification, we must ask whether it is indeed a sonification, whether it presents any musical structures and/or devices, and whether it is intended for artistic purposes. Referring to Hermann's systemic map of sound, musification exists in the intersection between Functional Sounds (which include sonification) and Music & Media Arts (Hermann, 2008, p. 5).

Furthermore, data as well as sound parameters can be hierarchised, so that primary data parameters are assigned to primary sound parameters; this approach was used to musify large and complex datasets described in Chapter 4. The piece *Wasgiischwashäsch* explores the mappings of musical parameters which are rarely used in sonification, even when Western classical music conventions are used. Chapter 6 described the use of parameters such as timbre, pitch registers, dynamics and extended techniques.

We have found that numerous musical parameters can be used effectively in sonification. In fact, it is useful to use a range of parameters in musification because it reflects the compositional process of pieces written without sonification techniques. The use of extended data and sound parameters should be encouraged and extended to advance the field.

How can we evaluate the effectiveness of sonification in music from a scientific, musical, and a combined point of view? Which are the criteria that can determine a musification's functional and artistic qualities?

In Chapter 7 we have shown that the evaluation of musification involved the evaluation of sonification, music and factors arising from the combination of both. While many aspects of a musification can be evaluated, music's subjective nature means that no definitive objective evaluation can be reached. We have proposed an evaluation framework for musification which allows us to plot a musification on an evaluation chart; the chart in 7.3.3 can be used to determine whether a sonification is indeed a musification and how it scores on the artistic and the functional axes.

Five evaluation criteria have been proposed. *Gain* is the gain derived from using musical structures in a sonification and using sonification in an artistic context.

Clarity, intuitivity and learning effort is the efficiency of the information transmission process; what the listener can understand, whether this is intuitive and what learning effort is required to understand the information. *Aesthetics* includes musical aesthetics but also the congruency between sonification and music and the listening immersion achieved; it asks not only for the pleasantness of the sound but also for the efficiency of the aesthetic choices. The *Sonification method* is the methodology used in the musification; deviations from conventional methods might be justified for artistic or functional reasons. Finally, the *Audience feedback* closes the loop in the information transmission process: has the listener understood the information and emotionally engaged with the musification? These criteria should be applied with a particular focus on the musical aspects of the sonification process.

8.1.2 Research Outcomes

The thesis follows the research aims described in 1.2 to explore the research questions. They have been addressed in the following ways:

1. To develop a framework for sonification as a compositional tool, that includes the definition of musification. The framework is intended for composers seeking to use data sonification for creative purposes, with a focus on the creation of electroacoustic music.

The Data-Mappings-Language-Emotions framework for sonification as a compositional tool was proposed in 3.7; it was used to produce the four pieces in the portfolio. Musification was defined in Chapter 2 as a result of a survey of existing literature and creative practices. The definition was crafted to suit the specific requirements of composers working with a scientific method such as sonification. The practical application of the framework as described in Chapters

3 to 6 can be used by prospective musification composers to approach this type of composition. Further issues around musification were discussed: the juxtaposition of sonification and visualisation (Chapter 4), the collaborative process (Chapter 4), sonification as augmented reality (Chapter 5), sonification as a tool to translate the environment into music (Chapter 5), and the use of musical borrowing in sonification (Chapter 6).

2. To create a portfolio of musifications with a range data from different scientific disciplines. A variety of datasets, musical languages, performance settings and multimedia approaches are to be used in the composition of the research pieces. Best practice is to be explored for each of these combinations and approaches.

The portfolio of compositions is comprised of four pieces using climate change, environmental and dark matter data and acousmatic, audio-visual, live electronics and orchestral media. They are described in chapters 3 to 6.

3. To develop an evaluation framework for musification, in terms of aesthetic perception and scientific understanding. Existing sonification practices, particularly in an artistic context, will be reviewed and evaluated to determine the gaps in knowledge and current shortcomings of the method. A novel evaluation method suited to musification is to be theorised.

In Chapter 7, an evaluation framework is proposed which incorporates existing criteria from literature and adapts it to suit the needs of musification as defined in Chapter 2.

8.1.3 Contributions to Knowledge

- Portfolio of compositions: The portfolio is the main contribution of this project. Four musifications were composed; they each use different datasets and different musical languages or styles. They can be used in performance or for study by prospective musification composers. The portfolio also demonstrates that a practice-as-research methodology is appropriate in sonification research.

- Composition framework: The composition framework provides composers and scientists with a basis for composition and a guide for best practice in the composition of sonification and musification. It unifies a practice which is often carried out by individual parties and has no specific guidelines; it also focuses on the musical aspects of the practice.

- Evaluation framework: The evaluation framework seeks to address an issue in the field of sonification and musification which has no specific guidelines on evaluation, and which has no tradition of substantial statistical evaluation. This framework could also be of interest to other fields of practice-as-research.

- Shared working relationships in sonification: The term of 'collaboration' has been critically assessed and found to be wrongly applied to many shared working relationships. Existing 'collaborations' in sonification and musification were evaluated and determined to often not being true collaborations, but rather shared working relationships. Group psychology concepts such as Transactive Memory Systems can be considered to create an effective shared working relationship. Interdisciplinary collaborations in sonification should be built around a common interest in sonification and a willingness to share different tasks in the process.

- Musical hierarchies in sonification: Primary and secondary data and music parameters were identified and mapped to each other. It was found to be a useful practice as it reflects the conventional compositional process and allows for a more efficient sonification of complex data.

- Sonification as representation of human and natural soundscapes: Sonification was contextualised within the tradition of musical representation of human and natural soundscapes. We showed that sonification combine the compositional urge to introduce current technology in the creative process, and a method to represent the new soundscapes of the contemporary world.

- Use of musical borrowing in sonification: Musical borrowing of a well-known piece, the *William Tell Overture*, was used in the piece *Wasgiischwashäsch* and shown to be an efficient method of information transmission. Because the technique harnesses the listeners' shared musical knowledge, it simplifies the communication process as theorised in the Shannon-Weaver Model of Communication.

- Shannon-Weaver Model of Communication applied to sonification: We showed that the Shannon-Weaver Model of Communication can be used to describe the information transmission process of sonification. This contextualisation of the process of sonification can be used as an analytical tool.

- Orchestral sonification: The piece *Wasgiischwashäsch* was written by 'hand'; the mappings were carried out on paper rather than by a computer. We showed that this can be preferable when using complex musical mappings that rely on compositional skills and instincts; they can be far more complicated to be carried out through algorithms.

- Importance of the evaluation of musification: The discussion on the evaluation of musification argues that the quantitative and qualitative of 'artistic' sonification is crucial to raise the quality of the field. The idea that music should not be evaluated at all was debunked as a romantic and detrimental ideal.

8.2 Performances and Impact

8.2.1 Performances

Blyth-Eastbourne-Wembury

- Launch Event of the *Students Organizing for Sustainability* network – Eden Project (Bodelva, UK) – 9 October 2015

- BFE/RMA Research Students' Conference – University of Bangor – 7 January 2016

The Sonification of Dark Matter

- Peninsula Arts Contemporary Music Festival – University of Plymouth – 26-28 February 2016

The Voice of the Sea

- Peninsula Arts Contemporary Music Festival – University of Plymouth - 26 February 2017

- Balance/Unbalance Conference – University of Plymouth – 21 August 2017

- BFE/RMA Research Student's Conference – University of Huddersfield – 5 January 2018

- The Infinite Guide – Karst Gallery, Plymouth – 8 September 2018

Wasgiischwashäsch

- Peninsula Arts Contemporary Music Festival – University of Plymouth – 25 February 2017

8.2.2 Impact

- If you could listen to dark matter, just what would it sound like? *The Observer*, 14 February 2016. Available at:

<http://www.theguardian.com/technology/2016/feb/16/music-festival-plymouth-dark-matter>

- Dark Matter: Invisible material to be represented through the medium of song. *The Independent*, 24 February 2016. Available at:

<http://www.independent.co.uk/arts-entertainment/music/news/dark-matter-invisible-material-to-be-represented-through-medium-of-song-a6894056.html>

- Dark Matter in song. *Physics World*, 1 April 2017.

- Being a Scientist Composer: Representing our environment in music. Artist talk at Kaleider (Exeter), 5 August 2016.

- Voice 2.0 – Peninsula Arts Contemporary Music Festival. *Music Matters*, BBC Radio 3, 25 February 2017. Available at:

<https://www.bbc.co.uk/programmes/b08g47yt>

8.2.3 Conferences

- Blyth-Eastbourne-Wembury (composition workshop) – BFE/RMA Research Students' Conference – University of Bangor – 7-9 January 2016.

- Sonification as a Compositional Tool: *Blyth-Eastbourne-Wembury* - 3rd Conference on New Music Concepts – Treviso, Italy – 5-6 March 2016.
- The Scientist-Composer: Dark Matter Sonification as Music Composition - Symposium on Music Composition on Interdisciplinary Practice - University of York - 28-29 June 2016.
- Sonification of Dark Matter: Challenges and Opportunities - 13th Sound and Music Computing Conference - Hamburg, Germany - 31 August–3 September 2016.
- Echoing our Environment: Sonification in Electroacoustic Music as part of a Musical Tradition - BFE/RMA Research Students' Conference - Canterbury Christ Church University - 5-7 January 2017.
- But does it sound nice? Evaluating the success of sonification as a compositional tool (poster) - RMA Annual Conference - University of Liverpool – 7-9 September 2017.
- But does it sound nice? Evaluating the success of sonification as a compositional tool – Digital Research in the Humanities Conference – University of Plymouth – 10-13 September 2017.
- The Voice of the Sea (Piece and paper) – BFE/RMA Research Students' Conference – University of Huddersfield – 4-6 January 2018.

8.2.4 Publications

- Sonification as a Compositional Tool: Blyth-Eastbourne-Wembury, *Proceedings of the 3rd Conference on New Music Concepts*, 3-5 March 2017.

- Sonification of Dark Matter: Challenges and Opportunities, *Proceedings of the 13th Sound and Music Computing Conference*, 31 August–3 September 2016.

- Musical Borrowing in Sonification, *Organised Sound* (forthcoming).

8.3 Implications and Future Research

The research presented in this thesis is original and can provide interesting suggestions for future research in the field of musification. First, it defines the very term of musification. This is crucial for the practice as composers and scientists to often make claims about sonification and musification to appeal to a sense of novelty rather than produce quality products. The accompanying portfolio is an attempt to create four distinctive musifications to which I can be held accountable in terms of quality, process and musical and scientific integrity. The compositional framework will give composers and scientists a starting point and a guide to producing musifications. I hope that it will help unify an otherwise fractured field, not the least because of the isolation in which most composers work. It would have been very satisfying to be able to produce a ‘one-size-fits-all’ framework and software package for sonification that could use any data and spit out an appropriate sonification. Unfortunately, I have shown that every dataset is different and requires an individual approach. Therefore, only a theoretical framework is possible; the process must still be personalised for each sonification. This should not be seen as a weakness of musification; rather, it demonstrates the sheer variety of data and music possibilities there are. Finally, the evaluation framework is novel and of utmost importance, particularly because of the fairly widely held view that musification should not actually be evaluated. The idea that an artistic product should not be submitted to the same scrutiny as functional sonification has for too long meant that artistic sonification has been a gimmick

and has sullied the reputation of a practice with fantastic potential for new creativity, scientific exploration, outreach, audience experiences, etc.

Future work irremediably involves the application of the composition framework to more datasets and musical styles. This will evidence any gaps in the model and fine tune it for future use. The concept of orchestral sonification, where acoustic instruments are used for sound production, is an exciting possibility in the aesthetics of sonification. The combination of sonification and visualisation to create a product with augmented cognitive possibilities might result in a 'killer application' which the field is seeking; the added cognitive bandwidth afforded by this juxtaposition promises important advances in data communication. More work is also needed to explore interdisciplinary collaborations between composers and scientists: how to establish them and how to organise their working processes effectively.

Future work should explore potential software developments which could simplify the musification process, even if it cannot carry out the entire creative process. The use of computer-aided orchestration software (Miranda, 2018) might democratise the process of writing high quality musification, and particularly orchestral sonifications. More creative exploration is needed on empathetic sonification to find ways of creating intuitive and meaningful links between data and the sound chosen to transmit them.

Finally, the evaluation framework needs to be applied widely to study its worth and further perfect it. It must be applied to more pieces, in more styles, by more users; this will render the method statistically relevant. This will hopefully lead to a wider acceptance of the need for evaluation in musification. It will also allow for a qualitative evaluation of a field which is often considered a novelty or a gimmick.

Having a framework and vocabulary to discuss musifications encourages a higher standard in composition. I hope that I have contributed to raising the quality of the field of musification.

References

- Abenavoli, L. (2009). The Pulse of the Earth and sonification. *AI & Society*, 27, pp. 277-79.
- Abraham, G. (ed.) (1982). *The Age of Beethoven 1780-1830*. Oxford: Oxford University Press.
- Abraham, G. (1982). Beethoven's Chamber Music. In: Abraham, G. (ed.) (1982). *The Age of Beethoven 1780-1830*. Oxford: Oxford University Press, pp. 255-302.
- Adderley, W.P. and Young, M. (2009). Ground-breaking: Scientific and Sonic Perceptions of Environmental Change in the African Sahel. *Leonardo*, 42(5), pp. 404-411.
- Allen, R.E. (1992). *The Concise Oxford Dictionary*. Oxford: Clarendon Press.
- Angliss, S. (2011). *Euler's Number and the price of fish*. Mad Art Lab. Available at: <http://madartlab.com/eulernumberfish/> [Accessed 17 July 2017].
- Anscombe, F.J. (1973). Graphs in Statistical Analysis. *The American Statistician*, 27(1), pp. 17-21.
- Aplin, K.L. and Williams, P.D. (2011). Meteorological phenomena in Western classical orchestral music. *Weather*, 66(11), pp. 300-306.
- AQA (2018). *GCSE: Music (8271) (Version 1.2)*. Manchester: AQA.
- Arts and Humanities Research Board (2003). *The Arts and Humanities: Understanding the Research Landscape*. Arts and Humanities Research Council (UK). Available at: <http://www.ahrc.ac.uk/documents/publications/arts-and-humanities-research-landscape/> [Accessed 23 April 2017].
- Baalman, M.A.J. (2010). Spatial Composition Techniques and Sound Spatialisation Technologies. *Organised Sound*, 15(3), pp. 209-218.
- Babbitt, M. (1958). Who cares if you listen? *High Fidelity* (February 1958), pp. 38-41 and pp. 126-127.
- Ball, P. (2018). Only great work can really justify sci-art collaborations. *New Scientist*, 3163.
- Ballora, M. (2014). Sonification, Science and Popular Music: In search of the 'wow'. *Organised Sound*, 19, pp. 30-40.
- Banks, M. (2016). Dark Matter in song. *Physics World*, 1 April 2017.

- Barham, J. (2014). 'Not Necessarily Mahler': Remix, Samples and Borrowing in the Age of Wiki. *Contemporary Music Review*, 33(2), pp. 128-147.
- Barrass, S. (1997). *Auditory Information Design*. PhD Thesis. Australian National University.
- Barrass, S. (2003). *Sonification from a design perspective*. In: International conference on auditory display (ICAD 2003).
- Barrass, S. (2012). The aesthetic turn in sonification towards a social and cultural medium. *AI & Soc*, 27, pp. 177-81.
- Barrass, S. and Vickers, P. (2011). Sonification Design and Aesthetics. In: Hermann, T., Hunt, A. and Neuhoff J.G. (2011). *The Sonification Handbook*. Berlin: Logos Publishing House, pp. 145-71.
- Barrass, S., Whitelaw, M. and Bailes, F. (2006). Listening to Mind Listening: An Analysis of Sonification Reviews, Designs and Correspondences. *Leonardo Music Journal*, 16, pp. 13-19.
- Barrett, N. (2002). Spatio-musical composition strategies. *Organised Sound*, 7(3), pp. 313-323.
- Barrett, N. (2007). Trends in electroacoustic music. In: Collins, N. and d'Escriván, J. (eds.) (2007). *The Cambridge Companion to Electronic Music*. Cambridge: Cambridge University Press, pp. 232-255.
- Barrett, N. and Mair, K. (2014). *Aftershock*: A science-art collaboration through sonification. *Organised Sound*, 19, pp. 4-16.
- Bašić, N. (2005). *Sea Organ on the New Marine Parade of the Zadar Peninsula*. Available at: www.publicspace.org/en/works/d078-morske-orgulje/prize:2006 [Accessed June 2014].
- Baumann, M.P. (2010). Ranz des Vaches. *Dictionnaire historique de la Suisse*. Available at: <http://www.hls-dhs-dss.ch/textes/f/F11889.php> [Accessed 29 January 2018].
- Belfast Telegraph (2016). Video: Listen to the struggle of the pound since Brexit. *Belfast Telegraph*. Available at: <https://www.belfasttelegraph.co.uk/video-news/video-listen-to-the-struggle-of-the-pound-since-brexite-35112287.html> [Accessed 5 June 2018].
- Bharadwaj, S., Bhavsar, S. and Shieth, J. (2004). The size of the longest filaments in the universe. *The Astrophysical Journal*, 606, pp. 25-31.
- Bicknell, J. (2001). The Problem of Reference in Musical Quotation: A Phenomenological Approach. *The Journal of Aesthetics and Art Criticism*, 59(2), pp. 185-191.

- Bjørnsten, T. (2015). From Particle Data to Particular Sounds: Reflections on The Affordances of Contemporary Sonification Practices. *Journal of Sonic Studies*, 10.
- Blattner, M.M., Sumikawa, D.A. and Greenberg, R.M. (1989). Earcons and Icons: Their Structure and Common Design Principles. *Human-Computer Interaction*, 4, pp. 11-44.
- Bonebright, T.L. and Flowers, J.H. (2011). Evaluation of Auditory Display. In: Hermann, T., Hunt, A. and Neuhoff J.G. (2011). *The Sonification Handbook*. Berlin: Logos Publishing House, pp. 111-44.
- Bonet, N. (2014). Narratives in Latin American Electroacoustic Music: Does a Latin American Electroacoustic Music exist? *Sines & Squares Festival*. Available at: http://www.nuriabo.net/file/repository/Narratives_Latin_American_EA_Music.pdf [Accessed 30 August 2018].
- Bonet, N., Kirke, A. and Miranda, E. (2016a). *Blyth-Eastbourne-Wembury*: Sonification as a compositional tool in electroacoustic music. *Proceedings of the 2nd International Conference on New Musical Concepts*.
- Bonet, N., Kirke, A., Miranda, E. (2016b). Sonification of Dark Matter: Challenges and Opportunities. *Proceedings of the Sound and Music Computing Conference*.
- Born, G. and Barry, A. (2010). ART-SCIENCE. *Journal of Cultural Economy*, 3(1), pp. 103-19.
- Boyd, D. and Crawford, K. (2013). Big Data als kulturelles, technologisches und wissenschaftliches Phänomen: Sechs Provokationen. In: Geiselberger, H. and Moorstedt, T. (2013). *Big Data: Das neue Versprechen der Allwissenheit*. Berlin: Suhrkamp Verlag, pp. 187-202.
- Brazil, E. and Fernström, M. (2011). Auditory Icons. In: Hermann, T., Hunt, A. and Neuhoff J.G. (2011). *The Sonification Handbook*. Berlin: Logos Publishing House, pp. 325-38.
- Burkholder, J.P. (1994). The Uses of Existing Music: Musical Borrowing as a Field. *Notes*, 50(3), pp. 851-870.
- Buttall, P.R. (2017). Innovation and Reinvention Take the Stage. *Seen and Heard International*. Available at: <http://seenandheard-international.com/2017/02/innovation-and-reinvention-take-the-stage/> [Accessed 2 February 2018].
- Castelle, B., Dodet, G. Masselink, G. and Scott, T. (2018). Increased Winter-Mean Wave Height, Variability and Periodicity in the Northeast Atlantic Over 1949-2017. *Geophysical Research Letters*, 45.

Castelvecchi, D. and Witze, A. (2016). Einstein's gravitational waves found at last. *Nature*, 11 February 2016. Available at: doi:10.1038/nature.2016.19361 [Accessed 20 April 2017].

cequelaino (2008). *Bernard Romanens - Le Ranz des vaches*. Available at: <https://www.youtube.com/watch?v=DL1dXLLe5No> [Accessed 29 January 2018].

CERN (2012). *Dark Matter*. Available at: <http://home.cern/about/physics/dark-matter> [Accessed 28 November 2017].

Chandler, D. (1994). *The Transmission Model of Communication*. Available at: <https://archive.li/20120716111950/http://www.aber.ac.uk/media/Documents/short/trans.html> [Accessed 21 June 2018].

Chatzichristodoulou, M. and Zerihan, Rachel (eds.) (2012). *Intimacy: Across Visceral and Digital Performance*. London: Palgrave Macmillan.

Cherston, J., Goldfarb, S., Hill, E. and Paradiso J.A. (2016). Sonification Platform for Interaction with Real-Time Particle Collision Data from the ATLAS Detector. *CHI'16 Extended Abstracts*, pp. 1647-1653.

Clark, M. (2009). The Year in Dubstep, Grime, and Funky 2009. *Pitchfork*. Available at: <https://pitchfork.com/features/grime-dubstep/7728-grime-dubstep/> [Accessed 24 April 2018].

Clark, N. (2016). Dark Matter: Invisible material to be represented through the medium of song. *The Independent*, 24 February 2016. Available at: <http://www.independent.co.uk/arts-entertainment/music/news/dark-matter-invisible-material-to-be-represented-through-medium-of-song-a6894056.html> [Accessed 20 February 2017].

Collins, N. and d'Escriván, J. (eds.) (2007). *The Cambridge Companion to Electronic Music*. Cambridge: Cambridge University Press.

Connor, S. (2013). Photophonics. *SoundEffects*, 3(1), pp. 137–152.

Copland, A. (1939). *What to Listen for in Music*. New York: McGraw-Hill.

Cousineau, M., McDermott, J.H. and Peretz, I. (2012). The basis of musical consonance as revealed by congenital amusia. *PNAS*, 109(48), pp. 19858-19863.

Datawell. Directional Waverider MkIII. Available at: http://www.datawell.nl/Portals/0/Documents/Brochures/datawell_brochure_dwr-mk3_b-09-08.pdf (accessed 10 January 2018).

Davis, N. (2016). If you could listen to dark matter, just what would it sound like? *The Observer*, 14 February 2016.

De Campo, A. (2007). A Data Sonification Design Space Map. *Proceedings of the 2nd International Workshop on Interactive Sonification*, pp. 1-4.

- Degara, N., Nagel, F. and Hermann, T. (2013). Sonex: An Evaluation Exchange Framework for Reproducible Sonification. *Proceedings of the 19th International Conference on Auditory Displays*, pp. 167-174.
- Dirac, P.A.M. (1939). The Relation between Mathematics and Physics. *Proceedings of the Royal Society (Edinburgh)*, 59(2), pp. 122-29. Available at: <http://www.damtp.cam.ac.uk/events/strings02/dirac/speach.html> [Accessed 22 July 2017].
- Dombois, F. (2001). Using Audification in Planetary Seismology. *Proceedings of the 2001 Conference on Auditory Display*, pp. 227-230.
- Dubus, G. and Bresin, R. (2013). A Systematic Review of Mapping Strategies for the Sonification of Physical Quantities. *PLoS ONE*, 8(12), pp. 1-28.
- Dunham, P. and Johnson, B. (2015). A Fractured Earth: Sonification and Spatialisation of Seismic Data with MAX/MSP and Speaker.motion. *Proceedings of the Australasian Computer Music Conference (ACMC'15)*.
- Dunn, J. and Clark, M.A. (1999). "Life Music": The Sonification of Proteins. *Leonardo*, 32(1), pp. 25-32.
- Durack, P.J., Wijffels, S.E. and Gleckler, P.J. (2014). Long-term sea-level change revisited: the role of salinity. *Environmental Research Letters*, 9(11), pp. 1-11.
- Eacott, J. (2012). Flood Tide: Sonification as musical performance – an audience perspective. *AI & Society*, 27, pp. 189-195.
- Elisabeth, M. (2011). *Julius von Bismarck: the first Prix Ars Electronica Collide @CERN laureate*. Available at: <http://arts.web.cern.ch/news/2011/julius-von-bismarck-first-prix-ars-electronica-collidecern-laureate> [Accessed 24 October 2017].
- El País (2016). El sonido de las ondas gravitacionales, en tu móvil. *El País*, 23 February 2016. Available at: http://elpais.com/elpais/2016/02/11/ciencia/1455216078_439368.html [Accessed 20 April 2017].
- Ensia (2015). *The sound of climate change from the Amazon to the Arctic*. Available: <https://vimeo.com/127083533> [Accessed 23 October 2017].
- Fitch, F. and Heyde, N. (2007). 'Recercar' – The Collaborative Process as Invention. *Twentieth-Century Music*, 4(1), pp. 71-95.
- Fryer, D.L. (2015). Sonifying the Higgs: Choice and Coding Orientation in the Recontextualization of Quantitative Data. In: Kvåle, G., Maagerø, E. and Veum, A. (Eds.) (2015). *Kontekst, språk og multimodalitet - nyere sosiosemiotiske perspektiver*. Oslo: Fagbokforlaget, pp. 123-137.

Gartner. *Gartner Hype Cycle*. Available at: <http://www.gartner.com/technology/research/methodologies/hype-cycle.jsp> [Accessed 19 July 2017].

Geiselberger, H. and Moorstedt, T. (2013). *Big Data: Das neue Versprechen der Allwissenheit*. Berlin: Suhrkamp Verlag.

Gena, P. and Strom, C. (1995). Musical Synthesis of DNA Sequences. *Proceedings of the Sixth International Symposium on Electronic Art*, pp. 83-85.

Gena, P. and Strom, C. (2001). A Physiological Approach to DNA. *The Proceedings of CADE 2001: the 4th Computers in Art and Design Education Conference*, pp. 129-134.

Giannachi, G. (2012). Representing, Performing and Mitigating Climate Change in Contemporary Art Practice. *Leonardo*, 45(2), pp. 124-131.

Gibson, J. (2006). sLowlife: Sonification of Plant Study Data. *Leonardo Music Journal*, 16, pp. 42-44.

Giddens, A. (2009). *The Politics of Climate Change*. Cambridge: Polity Press.

Goethals, G.R. and Darley, J.M. (1987). Social Comparison Theory: Self-Evaluation and Group Life. In: Mullen, B. and Goethals, G.R. (eds.) (1987). *Theories of Group Behavior*. New York: Springer-Verlag, pp. 21-47.

Goves, L. (2010). *Portfolio of Composition with Accompanying Commentary*. PhD Thesis. University of Southampton.

Gresham-Lancaster, S. (2012). Relationships of sonification to music and sound art. *AI & Society*, 27, pp. 207-12.

Griffiths, P., Lindley, M. and Zannos, I. (2001). Microtone. In: Sadie, S. and Tyrrell, J. (2001). *The New Grove Dictionary of Music and Musicians (2nd ed.)*. London: Macmillan Publishers.

Grond, F. and Berger, J. (2011). Parameter Mapping Sonification. In: Hermann, T., Hunt, A. and Neuhoff J.G. (2011). *The Sonification Handbook*. Berlin: Logos Publishing House, pp. 363-397.

Hamilton, A. (2005). *Aesthetics & Music*. London: Continuum.

Hayashi, K. and Munakata, N. (1984). Basically musical. *Nature*, 310, p. 96.

Hayden, S. and Windsor, L. (2007). Collaboration and the composer: Case studies from the end of the 20th century. *Tempo*, 61, pp. 28-39.

Hermann, T. (2008). Taxonomy and definition for sonifications and auditory display. *Proceedings of the 14th International Conference on Auditory Display*.

- Hermann, T. (2011). Model-based Sonification. In: Hermann, T., Hunt, A. and Neuhoff J.G. (2011). *The Sonification Handbook*. Berlin: Logos Publishing House, pp. 399-427.
- Hermann, T., Hunt, A. and Neuhoff J.G. (2011). Introduction. In: *The Sonification Handbook*. Berlin: Logos Publishing House, pp. 1-6.
- Hermann, T., Hunt, A. and Neuhoff J.G. (2011). *The Sonification Handbook*. Berlin: Logos Publishing House.
- Hermann, T., Meinicke, P., Bekel, H., Ritter, H., Müller, H.M. and Weiss, S. (2002). Sonification for EEG Data Analysis. *Proceedings of the 2002 International Conference on Auditory Display*.
- Hermann, T. and Ritter, H. (2004). Sound and Meaning in Auditory Data Display. *Proceedings of the IEEE*, 92(4), pp. 730-41.
- Howard-Jones, E. (1935). Arrangements and Transcriptions. *Music & Letters*, 16(4), pp. 305-311.
- Hughes, S. (2016). *The "sound" of spacetime: Overview*. Astrophysical general relativity @ MIT. Available at: <http://gmunu.mit.edu/sounds/sounds.html> [Accessed 20 April 2017].
- Hunter, P.G. and Schellenberg, E.G. (2010). Music and Emotion. In: Jones, M.R., Fay, M., Richard, R. and Popper, A.N. (2010). *Music Perception*, Springer Handbook of Auditory Research 36, pp. 129-64.
- Ibrahim, A.A.A., Yassin, F.M.D., Sura, S. and Andrias, R.M. (2011). Overview of Design Issues and Evaluation of Sonification Applications. *IEEE*, pp. 77-82.
- Johnson-Laird, P.N., Kang, O.E. and Leong, Y.C. (2012). On Musical Dissonance. *Music Perception: An Interdisciplinary Journal*, 30(1), pp. 19-35.
- Jones, J. (2015). Should art respond to science? On this evidence, the answer is simple: no way. *The Guardian*, 23 April 2015.
- Jones, M.R., Fay, M., Richard, R. and Popper, A.N. (2010). *Music Perception*, Springer Handbook of Auditory Research 36.
- Jordanous, A.K. (2012). *Evaluating Computational Creativity: A Standardised Procedure for Evaluating Creative Systems and its Application*. PhD Thesis. University of Sussex.
- Joyce, A.E. (2006). *The coastal temperature network and ferry route programme: long-term temperature and salinity observations*. Sci. Ser. Data Rep., Cefas Lowestoft, 43.

Kähler, R. and Abel, T. (2012). Interactive stereoscopic visualization of large-scale astrophysical simulation. *Proc. SPIE 8288, Stereoscopic Displays and Applications XXIII*.

Kähler, R., Hahn, O. and Abel, T. (2012). A Novel Approach to Visualizing Dark Matter Simulations. *IEEE Transactions on Visualization and Computer Graphics*, pp. 2078-87.

Karplus, K. and Strong, A. (1983). Digital Synthesis of Plucked-String and Drum Timbres. *Computer Music Journal*, 7(2), pp. 43-55.

Keefe, D.F., Karelitz, D.B., Vote, E.L. and Laidlaw, D.H. (2005). Artistic collaboration in designing VR visualizations. *IEEE Computer Graphics and Applications*, 25(2), pp. 18-23.

Keng, K.S.K. (2015). How many floods will these American cities have in 2030, 2045? *Public Radio International*. Available at: <https://www.pri.org/stories/2015-08-14/how-many-floods-will-these-american-cities-have-2030-2045> [Accessed 1 February 2018].

Kephart, W.M. (1950). A quantitative analysis of intragroup relationships. *American Journal of Sociology*, 55, pp. 544-549.

Kilb, D., Peng, Z., Simpson, D., Michael, A. and Fisher, M. (2012). *Listen, Watch, Learn: SeisSound Video Products*. Available at: http://www.seismosoc.org/publications/SRL/SRL_83/srl_83-2_es/ [Accessed 29 September 2017].

King, R.D. and Angus, C.G. (1996). PM – Protein music. *Bioinformatics*, 12(3), pp. 251-252.

Kirke, A., Freeman, S., and Miranda, E.R. (2015). Wireless Interactive Sonification of Large Water Waves to Demonstrate the Facilities of a Large-Scale Research Wave Tank. *Computer Music Journal*, 39(3), pp. 59-70.

Knebusch, J. (2007). The Perception of Climate Change. *Leonardo*, 40(2), p. 113.

Know Your Meme (2017). *Replacement Remixes*. Available at: <http://knowyourmeme.com/memes/replacement-remixes> [Accessed 1 February 2018].

Kolber, D. (2002). Hildegard Westerkamp's *Kits Beach Soundwalk*: shifting perspectives in real world music. *Organised Sound*, 7(1), pp. 41-43.

Kramer, G. (1994a). An introduction to auditory display. In: Kramer, G. (ed.) (1994). *Auditory Display*, Santa Fe Institute, Studies in the Sciences of Complexity Proceedings 18, pp. 1-78.

Kramer, G. (ed.) (1994b). *Auditory Display*, Santa Fe Institute, Studies in the Sciences of Complexity Proceedings 18.

- Kramer, G. (1994c). A letter from Greg Kramer: founder of ICAD. *Proceedings of the International Workshop on Interactive Sonification*.
- Kramer, G., Walker, B., Bonebright, T., Cook, P., Flowers, J.H., Miner, N. and Neuhoff, J. (1999). *Sonification Report: Status of the Field and Research Agenda*. Santa Rosa, CA: ICAD/NSF. Available at: <http://www.icad.org/websiteV2.0/References/nsf.html> [Accessed 24 April 2017].
- Krumhansl, C.L. and Cuddy, L.L (2010). A theory of Tonal Hierarchies. In: Jones, M.R., Fay, M., Richard, R. and Popper, A.N. (2010). *Music Perception*, Springer Handbook of Auditory Research 36, pp. 51-87.
- Kvåle, G., Maagerø, E. and Veum, A. (Eds.) (2015). *Kontekst, språk og multimodalitet - nyere sosiosemiotiske perspektiver*. Oslo: Fagbokforlaget.
- Landy, L. (1999). Reviewing the musicology of electroacoustic music: a plea for greater triangulation. *Organised Sound*, 4(1), pp.61-70.
- Landy, L. (2007). *Understanding the Art of Sound Organization*. Cambridge, MA: The MIT Press.
- Large, E.W. (2010). Neurodynamics of Music. In: Jones, M.R., Fay, M., Richard, R. and Popper, A.N. (2010). *Music Perception*, Springer Handbook of Auditory Research 36, pp. 201-31.
- Latané, B., Williams, K. and Harkins, S. (1979). Many hands make light the work: The causes and consequences of social loafing. *Journal of Personality and Social Psychology*, 43, pp. 822-832.
- Leamy, A. (2008). *The Phenomenon of the Scientist-Composer*. Master dissertation. National University of Ireland.
- Leavy, P. (2015). *Method meets Art: Arts-Based Research Practice*. New York: The Guildford Press.
- Leplâtre, G. and McGregor, I. (2004). How to Tackle Auditory Aesthetics? Discussion and Case Studies. *Proceedings of ICAD 2004*.
- LIGO Scientific Collaboration (2016). *LIGO Multimedia*. Available at: <http://www.ligo.org/multimedia.php> [Accessed 20 April 2017].
- Lindborg, P. and Liang, S. (2014). Hearing is Believing: Interactive Sonification of Weather Data from South-East Asia 1960-2099. *Environmental Visions 2014*.
- López, F. (2001). Blind Listening. In: Rothenberg, D. and Ulvaeus, M. (2001). *The Book of Music & Nature*. Middletown, CT: Wesleyan University Press, pp. 163-168.

Lorenzoni, I., Nicholson-Cole, S. and Whitmarsh, L. (2007). Barriers perceived to engaging with climate change among the UK public and their policy implications. *Global Environmental Change*, 17, pp. 445-459.

Lotis, T. (2003). The creation and projection of ambiphonic and geometrical sonic spaces with reference to Denis Smalley's *Base Metals*. *Organised Sound*, 8(3), pp. 257-267.

Loy, D.G. (1991). Connectionism and Musiconomy. In: Todd, P.M. and Loy D.G. (eds.) (1991). *Music and Connectionism*. Cambridge, MA: The MIT Press, pp. 20-38.

Maconie, R. (1990). *The Concept of Music*. Oxford: Clarendon Press.

Maloney, E.S (2008). *The Boater's Handbook: The Indispensable Look-it-up Book (4th ed.)*. New York: Hearst Books.

Manning, P. (2013). *Electronic and Computer Music (4th Ed.)*. Oxford: Oxford University Press.

Marks, L.E., Elisheva, B.-A., Lakatos, S. (2003). Cross-modal interactions in auditory and visual discrimination. *International Journal of Psychophysiology*, 50, pp. 125-145.

Mayer-Krees, G., Bargar, R. and Choi, I. (1994). Musical Structures in Data from Chaotic Attractors. In: Kramer, G. (ed.) (1994). *Auditory Display*, Santa Fe Institute, Studies in the Sciences of Complexity Proceedings 18, pp. 341-68.

McGee, R. (2009). *Auditory Displays and Sonification: Introduction and Overview*. Available at: mat.ucsb.edu/200C/2009_Students/projects/Ryan/200C_final_sonification.docx [Accessed 26 June 2017].

McGee, R. (2011). Sonifying the Cosmic Microwave Background. *Proceedings of the 17th International Conference on Auditory Display*.

McGookin, D. and Brewster, S. (2011). Earcons. In: Hermann, T., Hunt, A. and Neuhoff J.G. (2011). *The Sonification Handbook*. Berlin: Logos Publishing House, pp. 399-427.

MeteoSchweiz (2015a). *Vom einen Klimarekord zum nächsten: das war das Jahr 2014*. Available at: <http://www.meteoschweiz.admin.ch/home/suche.subpage.html/de/data/blogs/2015/6/vom-einen-klimarekord-zum-naechsten.html?query=jahres-temperatur+mittel&topic=0> [Accessed 29 January 2018].

MeteoSchweiz (2015b). *Das globale Klima ist auf Rekordjagd – auch in der Schweiz?*. Available at: <http://www.meteoschweiz.admin.ch/home/aktuell/meteoschweiz->

blog.subpage.html/de/data/blogs/2015/11/das-globale-klima-ist-auf-rekordjagd-.html [Accessed 29 January 2018].

MeteoSchweiz (2016). *Ausnahmefall Schweiz – auch bei der Klimaerwärmung?*. Available at: <http://www.meteoschweiz.admin.ch/home/aktuell/meteoschweiz-blog.subpage.html/de/data/blogs/2016/4/ausnahmefall-schweiz-auch-bei-der-klimaerwaermung.html> [Accessed 29 January 2018].

Milgram, P. Takemura, H., Utsumi, A. and Kishino, F. (1994). Augmented Reality: A class of displays on the reality-virtuality continuum. *Proceedings of Telem manipulator and Telepresence Technologies*, 2351, pp. 282-292.

Miranda, E. (2016). The music of particle collisions. *Nature Physics*, 12, p.1.

Miranda, E., Antoine, A., Celerier, J.M., Desainte-Catherine, M. (2018). i-Berlioz: Interactive Computer-Aided Orchestration with Temporal Control. *Proceedings of the 5th International Conference of New Musical Concepts*, pp. 45-60.

Mullen, B. and Goethals, G.R. (eds.) (1987). *Theories of Group Behavior*. New York: Springer-Verlag.

NASA (n.d.). *Dark Energy, Dark Matter*. Available at: <https://science.nasa.gov/astrophysics/focus-areas/what-is-dark-energy/> [Accessed 28 November 2017].

National Union of Students (NUS) (2015). *We want artists for a sustainability event at the Eden Project*. Available at: <https://www.nus.org.uk/en/news/we-want-artists-for-a-sustainability-event-at-the-eden-project1/> [Accessed 27 April 2017].

Nattiez, J-J. (1990). *Music and discourse: toward a semiology of music*. Princeton, NJ: Princeton University Press.

Naughton, J. (2017). The rebirth of Google Glass shows the merit of failure. *The Guardian*, 23 July 2017.

Nelson, R. (2006). Practice-as-research and the Problem of Knowledge. *Performance Research*, 11(4), pp. 105-116.

Neuhoff, J. (ed.) (2004). *Ecological psychoacoustics*. New York: Academic Press.

Ohno, S. and Ohno, M. (1986). The All Pervasive Principle of Repetitious Recurrence Governs Not Only Coding Sequence Construction But Also Human Endeavor in Musical Composition. *Immunogenetics*, 24, pp. 71-78.

OMonsTaa (2017). *The bee movie but every time they say bee it gets faster*. Available at: <https://www.youtube.com/watch?v=ygggcqKmUts> [Accessed 1 February 2018].

- Organisation for Economic Cooperation and Development (OECD) (2002). *Frascati Manual: Proposed Standard Practice for Surveys on Research and Experimental Development*. Paris: OECD Publication Service.
- Pawlowicz, R. (2013). Key Physical Variables in the Ocean: Temperature, Salinity, and Density. *Nature Education Knowledge*, 4 (4), p. 13.
- Perron, J. (2000). *Lorella Abenavoli: Le Souffle de la Terre (Paris, France)*. Available at: <http://www.fondation-langlois.org/html/e/page.php?NumPage=268> [Accessed 28 September 2017].
- Pesic, P. and Volmar, A. (2014). Pythagorean Longings and Cosmic Symphonies: The Musical Rhetoric of String Theory and the Sonification of Particle Physics. *Journal of Sonic Studies*, 8.
- Pilkington, M. (2013). *Portfolio of Original Electroacoustic Compositions*. PhD Thesis. University of Manchester.
- Pinch, T. and Bijsterveld, K. (eds.) (2012). *The Oxford Handbook of Sound Studies*. Oxford: Oxford University Press.
- Polli, A. (2005). Atmospherics/Weather Works: A Spatialized Meteorology Data Sonification Project. *Leonardo*, 38(1), pp. 31-36.
- Polli, A. (2006). *Heat and the Heartbeat of the City*: Sonifying data describing climate change. *Leonardo Music Journal*, 16, pp. 44-45.
- Polli, A. (2012). Soundscape, sonification, and sound activism. *AI & Society*, 27, pp. 257-268.
- Prebble, T. (2010). *Christchurch Quakes – Sonified*. Available at: <http://www.musicofsound.co.nz/blog/christchurch-quakessonified> [Accessed 29 September 2017].
- Prior, D. (2016). Loudspeaker Listening: Tabula Rasa or Augmented Reality. *Leonardo Music Journal*, 26, pp. 3-6.
- Quinn, M. and Meeker, L.D. (2001). Research Set To Music: The Climate Symphony and other Sonifications of Ice Core, Radar, DNA, Seismic and Solar Wind Data. *Proceedings of the 2001 International Conference on Auditory Display*.
- Rhoades, M. (2014). Hadronized Spectra (The LHC Sonifications): Sonification of proton collisions. *eContact!*, 16(3).
- Roddy, S. and Furlong, D. (2014). Embodied Aesthetics in Auditory Display. *Organised Sound*, 19(1), pp. 70-77.
- Rose-Coutré, R. (2007). Art as mimesis, aesthetic experience, and Orlan. *Q.rryptamine*, 1(2), pp. 4-6.

- Rothenberg, D. (2001). Introduction: Does Nature Understand Music? In: Rothenberg, D. and Ulvaeus, M. (2001). *The Book of Music & Nature*. Middletown, CT: Wesleyan University Press, pp. 1-10.
- Rothenberg, D. and Ulvaeus, M. (2001). *The Book of Music & Nature*. Middletown, CT: Wesleyan University Press.
- Russolo, L. (1913). *The Art of Noise*. In: Filliou, R. (trans.) (2004). *The Art of Noise (futurist manifesto, 1913)*. Ubu classics.
- Saldaña, J. (2011). *Ethnotheatre: Research from page to stage*. Walnut Creek, CA: Left Coast Press.
- Scaletti, C. (1994). Sound Synthesis Algorithms for Auditory Data Representations. In: Kramer, G. (ed) (1994). *Auditory Display: Sonification, Audification and Auditory Interfaces*. Reading, MA: Addison-Wesley Publishing Company, pp. 223-251.
- Scaletti, C. and Craig, A.B. (1991). Using sound to extract meaning from complex data. *SPIE*, 1459.
- Schafer, M.R. (1977). *The Soundscape: Our Sonic Environment and the Tuning of the World*. New York: Knopf.
- Scruton, R. (1997). *The Aesthetics of Music*. Oxford: Oxford University Press.
- Shams, L., Kamitani, Y., Thompson, S. and Shimojo, S. (2001). Sound alters visual evoked potentials in humans. *NeuroReport*, 12(17), pp. 3849-3852.
- Shannon, C.E. and Weaver, W. (1949). *The Mathematical Theory of Communication*. Urbana: The University of Illinois Press.
- Sinclair, P. (2012). Living with alarms: the audio environment in an intensive care unit. *AI & Society*, 27, pp. 269-76.
- Smalley, D. (2007). Space-form and the acousmatic image. *Organised Sound*, 12(1), pp. 35-58.
- Smith, S. (1990). Representing Data with Sound. *Proceedings of the Visualization 1990*, IEEE Computer Society Press.
- Sonifyer (2009). Audio-Visualisierung des Aare-Hochwassers vom August 2005. Available at: <http://www.sonifyer.org/sound/aare/unwetter2005/?id=34> [Accessed 6 June 2018].
- Stefani, E. and Lauke, K. (2010). Music, Space and Theatre: Site-specific approaches to multichannel spatialisation. *Organised Sound*, 15(3), pp. 251-259.

- Stiefel, V. (2002). A Study of the Choreographer/Composer Collaboration. *Princeton University Centre for Arts and Cultural Policy Studies Working Paper Series*, 22.
- Straebel, V. (2010). The Sonification Metaphor in Instrumental Music and Sonification's Romantic Implications. *Proceedings of the 16th International Conference on Auditory Display*, pp. 287-294.
- Straebel, V. and Thoben, W. (2014). Alvin Lucier's *Music for Solo Performer*. Experimental music beyond sonification. *Organised Sound*, 19(1), pp. 17-29.
- Students Organizing for Sustainability (SOS) (2017). *Students Organizing for Sustainability*. Available at: <http://sosnetwork.groupsie.com/main/summary> [Accessed 27 April 2017].
- Sturm, B.L. (2015). Pulse of an Ocean: Sonification of Ocean Buoy Data. *Leonardo*, 38(2), pp. 143-149.
- Supper, L. (2012a). *Lobbying for the Ear: The Fascination with and Academic Legitimacy of the Sonification of Scientific Data*. PhD thesis. Universitaire Pers Maastricht.
- Supper, L. (2012b). The search for the 'killer application': Drawing the boundaries around the sonification of scientific data. In: Pinch, T. and Bijsterveld, K. (eds.) (2012). *The Oxford Handbook of Sound Studies*. Oxford: Oxford University Press, pp. 249-70.
- Supper, L. (2014). Sublime frequencies: The construction of sublime listening experiences in the sonification of scientific data. *Social Studies of Science*, 44(1), pp. 34-58.
- Takahashi, R. and Miller, J.H. (2007). Conversion of amino-acid sequence in proteins to classical music: search for auditory patterns. *Genome Biology*, 8(405),
- Tanaka, A. (2012). Biomuse to Bondage: Corporeal Interaction in Performance and Exhibition. In: Chatzichristodoulou, M. and Zerihan, Rachel (eds.) (2012). *Intimacy: Across Visceral and Digital Performance*. London: Palgrave Macmillan, pp. 159-169.
- Taylor, A. (2016). 'Collaboration' in Contemporary Music: A Theoretical View. *Contemporary Music Review*, 35(6), pp. 562-578.
- Taylor, S. (2017). From Program Music to Sonification: Representation and the Evolution of Music and Language. *Proceedings of the 23rd Conference on Auditory Display*.
- Todd, P.M. and Loy D.G. (eds.) (1991). *Music and Connectionism*. Cambridge, MA: The MIT Press.

- Truax, B. (1996). Soundscape, Acoustic Communication, and Environmental Sound Composition. *Contemporary Music Review*, 15(1), pp. 49-65.
- Truax, B. (2000). The Aesthetics of Computer Music: A Questionable Concept Reconsidered. *Organised Sound*, 5(3), pp. 119-126.
- Unesco (1981). Background papers and supporting data on the Practical Salinity Scale 1978. *Unesco Technical Papers in Marine Science*, 37.
- Varèse, E. (1940). Organised Sound for the Sound Film. *The Commonwealth*, pp. 204-205.
- Vernelle, B. (1994). *Understanding and Using Groups*. London: Whiting & Birch.
- Vicinanza, D. (2012). *LHC Open Symphony*. Available at: <http://lhcopensymphony.wordpress.com> [Accessed 24 October 2017].
- Vickers, P. and Hogg, B. (2006). Sonification Abstraite/Sonification Concrète: An 'Aesthetic Perspective Space' for Classifying Auditory Displays in the Ars Musica Domain. *Proceedings of the 12th International Conference on Auditory Displays*, pp. 210-16.
- Vogt, H. (2011). A Quantitative Evaluation Approach to Sonifications. *Proceedings of the 17th International Conference on Auditory Display*.
- Vogt, K. and Höldrich, R. (2010). A Metaphoric Sonification Method – Towards the Acoustic Standard Model of Particle Physics. *Proceedings of the 16th International Conference on Auditory Display*, pp. 271-278.
- Vogt, K., Höldrich, R., Pirrò, D., Rumori, M., Rossegger, S., Riegler, W. and Tadel M. (2010). A Sonic Time Projection Chamber. Sonified Particle Detection at CERN. *Proceedings of the 16th International Conference on Auditory Display*, pp. 103-108.
- Walker, B. and Kramer, G. (2004). Ecological Psychoacoustics and Auditory Displays: Hearing, Grouping and Meaning Making. In: Neuhoff, J. (ed.) (2004). *Ecological psychoacoustics*. New York: Academic Press, pp. 150-75.
- Walker, B.N. and Nees, M.A. (2011). Theory of Sonification. In: Hermann, T., Hunt, A. and Neuhoff J.G. (2011). *The Sonification Handbook*. Berlin: Logos Publishing House, pp. 399-427.
- Weatherall, M. (1968). *Scientific Method*. London: The English Universities Press Ltd.
- Wegner, D.M. (1987). Transactive Memory: A Contemporary Analysis of the Group Mind. In: Mullen, B. and Goethals, G.R. (eds.) (1987). *Theories of Group Behavior*. New York: Springer-Verlag, pp. 185-208.

White, B.W. (1960). Recognition of Distorted Melodies. *The American Journal of Psychology*, 73(1), pp. 100-107.

Wierzbicki, J. (2014). The Imagined Sounds of Outer Space. *Journal of Sonic Studies*, 8.

Williams, A. (2018). Winter wave heights and extreme storms on the rise in Western Europe. Available at: <https://www.plymouth.ac.uk/news/winter-wave-heights-and-extreme-storms-on-the-rise-in-western-europe> [Accessed 28 April 2018]

Williams, D. (2016). Utility Versus Creativity in Biomedical Musification. *Journal of Creative Systems*, 1(1).

Wilsher, A. (2004). The Portsmouth Sinfonia – Thirty Years on. *The Portsmouth News*. Available at: <http://www.portsmouthsinfonia.com/media/portsmouthnews.html> [Accessed 2 February 2018].

Wolfe, K. (2014). Sonification and the Mysticism of Negation. *Organised Sound*, 19(3), pp. 304-309.

Worrall, D. (2009). *Sonification and Information: Concepts, Instruments and Techniques*. PhD Thesis. University of Canberra.

Wu, D., Li, C-Y. and Yao, D-Z. (2009). Scale-Free Music of the Brain. *PLoS ONE*, 4(6), e5915.

Yenigun, S. (2010). The 5 Deadliest Drops of 2010. *NPR Music*. Available at: <https://www.npr.org/2010/12/31/132490270/the-5-deadliest-drops-of-2010> [Accessed 24 April 2018].

Zylinska, J. (2009). *Bioethics in the Age of New Media*. Cambridge, MA: MIT Press.

Music

Abenavoli, L. (1996). Pulse of the Earth.

Adderley, W.P. and Young, M. (2007). Ground-breaking: Extreme Landscapes in Grains and Pixels.

Anon. (13th century). Summer is icumen in.

Anon. (18th century). God Save the Queen.

Barrett, N. (1999). Viva la Selva!

Barrett, N. (2011). Aftershock.

Barron, B. and Barron, L. (1956). *Forbidden Planet*.

Berezan, D. (2017). *Sea Lantern*.

Bonet, N. (2018). *Queen Canute*.

Climent, R. (2004). *Oxidising the Spectrum*.

Crawford, D. (2013). *A Song of Our Warming Planet*.

Eacott, J. (2008). *Flood Tide*.

Gauthier, D. (2017). *Measure for Measure for Measure*.

Honegger, A. (1923). *Pacific 231*.

Ikeda, R. (2014). *Supersymmetry*.

Janequin, C. (1529). *Le Chant des Oiseaux*.

LHC Symphony Orchestra (2012). *Higgs Boson (ATLAS Preliminary Data)*.

Liszt, F. (1853). *Festklänge*.

Liszt, F. (1857). *Hunnenschlacht*.

López, F. (1997). *La Selva*.

Lucier, A. (1965). *Music for Solo Performer*.

Lucier, A. (1993). *Panorama*.

Messiaen, O. (1956-58). *Catalogue d'oiseaux*.

Mozart, W.A. (1779). *Serenade No. 9*.

Pilkington, M. (2009). *Touch The Stars*.

Polli, A. (2003). *Atmospherics / Weather Works*.

Polli, A. (2004). *Heat and the Heartbeat of the City*.

Quinn, M and Meeker, L.D. (2000). *The Climate Symphony*.

Rammstein (2001). *Sonne*.

Rautavaara, E. (1972). *Cantus Arcticus*.

Rossini, G. (1829). *William Tell Overture*.

Schubert, F. (1827). *Winterreise*.

Stockhausen, K. (1955). *Gruppen*.

Tanaka, A. (1993). *Biomuse*.

Vanilla Ice (1990). Ice Ice Baby.

Villa-Lobos, H. (1957). New York sky line.

Westerkamp, H. (1989). Kits Beach Soundwalk.

Appendix 1: Score of
Wasgiischwashäsch

Wasgiischwashäsch **for chamber ensemble**

Núria Bonet

2016

Duration: 8 minutes

Clarinet in B flat

Melodica

Bassoon

Trumpet in B flat

Trombone

2 Timpani

Triangle

Cymbal

Bass Drum

Violin

Viola

Violoncello

Contrabass

Comments: Rossini' s *William Tell Overture* re-worked to describe the average temperature of Switzerland since the 1860' s. The chronological data define musical parameters of pitch, harmony, rhythm, tempo, timbre, register, articulation and dynamics.

Appendix 2: CD with Recordings of the Pieces

The accompanying CD contains stereo recordings of the pieces in the portfolio.

Blyth-Eastbourne-Wembury (8') is discussed in Chapter 3 and is named 'Blyth-Eastbourne-Wembury' on the CD. It is in .WAV format.

The Sonification of Dark Matter (17') is discussed in Chapter and is named 'The Sonification of Dark Matter' on the CD. It is in .MOV format.

The Voice of the Sea (4') is discussed in Chapter 5 and is named 'The Voice of the Sea 22Feb2017'. It is in in .AIF format. This recording uses buoy data from 22 February 2017 and was produced for the Music Matters programme on BBC Radio 3.

Wasgiischwashäs (8') is discussed in Chapter 6 and is named 'Wasgiischwashaesch' on the CD. It is in .WAV format. This performance was recorded on 25 February 2017 when the Peninsula Arts Sinfonietta premiered the work at the University of Plymouth's The House during the Peninsula Arts Contemporary Music Festival.

Appendix 2: CD with Recordings of the Pieces

The accompanying CD contains stereo recordings of the pieces in the portfolio.

Blyth-Eastbourne-Wembury (8') is discussed in Chapter 3 and is named 'Blyth-Eastbourne-Wembury' on the CD. It is in .WAV format.

The Sonification of Dark Matter (17') is discussed in Chapter and is named 'The Sonification of Dark Matter' on the CD. It is in .MOV format.

The Voice of the Sea (4') is discussed in Chapter 5 and is named 'The Voice of the Sea 22Feb2017'. It is in in .AIF format. This recording uses buoy data from 22 February 2017 and was produced for the Music Matters programme on BBC Radio 3.

Wasgiischwashäs (8') is discussed in Chapter 6 and is named 'Wasgiischwashaesch' on the CD. It is in .WAV format. This performance was recorded on 25 February 2017 when the Peninsula Arts Sinfonietta premiered the work at the University of Plymouth's The House during the Peninsula Arts Contemporary Music Festival.